

IntechOpen

Theoretical Concepts of Quantum Mechanics

Edited by Mohammad Reza Pahlavani



THEORETICAL CONCEPTS OF QUANTUM MECHANICS

Edited by **Mohammad Reza Pahlavani**

Theoretical Concepts of Quantum Mechanics

<http://dx.doi.org/10.5772/2075>

Edited by Mohammad Reza Pahlavani

Contributors

Luisberis Velazquez, Sergio Curilef, Paul Bracken, Francisco Bulnes, Sergei Petrovich Maydanyuk, Antonino Del Popolo, Vladislav Sergeevich Olkhovsky, Erasmo Recami, Gabino Torres-Vega, Valeriy Sbitnev, Marcello Cini, Cuneyt Berkdemir, Lubomír Rudolf Skála, Vojtěch Kapsa, Nikolai A. Alexandrovich Magnitskii, Ricardo Cordero-Soto, Tokuzo Shimada, Kazuhiro Kubo, Dominic Rochon, Raphaël Gervais Lavoie, Calin Gheorghe Buzea, Maricel Agop, Jonathan Bentwich, Fumihiko Sugino, Nicolay V. Lunin, Francisco De Zela, Antony Streklas, Cynthia Whitney, Ashot Gevorkyan, Kayode John Oyewumi

© The Editor(s) and the Author(s) 2012

The moral rights of the and the author(s) have been asserted.

All rights to the book as a whole are reserved by INTECH. The book as a whole (compilation) cannot be reproduced, distributed or used for commercial or non-commercial purposes without INTECH's written permission.

Enquiries concerning the use of the book should be directed to INTECH rights and permissions department (permissions@intechopen.com).

Violations are liable to prosecution under the governing Copyright Law.



Individual chapters of this publication are distributed under the terms of the Creative Commons Attribution 3.0 Unported License which permits commercial use, distribution and reproduction of the individual chapters, provided the original author(s) and source publication are appropriately acknowledged. If so indicated, certain images may not be included under the Creative Commons license. In such cases users will need to obtain permission from the license holder to reproduce the material. More details and guidelines concerning content reuse and adaptation can be found at <http://www.intechopen.com/copyright-policy.html>.

Notice

Statements and opinions expressed in the chapters are those of the individual contributors and not necessarily those of the editors or publisher. No responsibility is accepted for the accuracy of information contained in the published chapters. The publisher assumes no responsibility for any damage or injury to persons or property arising out of the use of any materials, instructions, methods or ideas contained in the book.

First published in Croatia, 2012 by INTECH d.o.o.

eBook (PDF) Published by IN TECH d.o.o.

Place and year of publication of eBook (PDF): Rijeka, 2019.

IntechOpen is the global imprint of IN TECH d.o.o.

Printed in Croatia

Legal deposit, Croatia: National and University Library in Zagreb

Additional hard and PDF copies can be obtained from orders@intechopen.com

Theoretical Concepts of Quantum Mechanics

Edited by Mohammad Reza Pahlavani

p. cm.

ISBN 978-953-51-0088-1

eBook (PDF) ISBN 978-953-51-4957-6

We are IntechOpen, the world's leading publisher of Open Access books Built by scientists, for scientists

4,100+

Open access books available

116,000+

International authors and editors

120M+

Downloads

151

Countries delivered to

Our authors are among the
Top 1%

most cited scientists

12.2%

Contributors from top 500 universities



WEB OF SCIENCE™

Selection of our books indexed in the Book Citation Index
in Web of Science™ Core Collection (BKCI)

Interested in publishing with us?
Contact book.department@intechopen.com

Numbers displayed above are based on latest data collected.
For more information visit www.intechopen.com



Meet the editor



Dr. Mohammad Reza Pahlavani, was born in 1958 at north-east of Iran. He has been obtained his Bs.c from Mashhad University (Mashhad-Iran), Ms.c from Tehran University (Tehran-Iran) and Ph.D from Indian Institute of technology Bombay (Mumbai-India) in nuclear physics at 2001. He was working as professor of physics in department of physics Mazandaran University since, and currently occupied as head of nuclear physics department. During last ten years, he published more than fifty papers in international journals, mostly in PRC, MPLB, IJMPE, and presented more than fifty papers in national and international conferences. He has guided more than 20 Ms.c student, 5 Ph.D student and taught several courses of Bs.c, Ms.c and Ph.D students of nuclear physics, mostly quantum mechanics, nuclear physics and classical mechanics for under graduate and graduate students.

Contents

Preface XIII

- Chapter 1 **Complementarity in Quantum Mechanics and Classical Statistical Mechanics 1**
Luisberis Velazquez Abad and Sergio Curilef Huichalaf
- Chapter 2 **The Physical Nature of Wave/Particle Duality 23**
Marcello Cini
- Chapter 3 **The Bicomplex Heisenberg Uncertainty Principle 39**
Raphaël Gervais Lavoie and Dominic Rochon
- Chapter 4 **Correspondence, Time, Energy, Uncertainty, Tunnelling, and Collapse of Probability Densities 65**
Gabino Torres–Vega
- Chapter 5 **Anisotropic Kepler Problem and Critical Level Statistics 81**
Kazuhiro Kubo and Tokuzo Shimada
- Chapter 6 **Theory of Elementary Particles Based on Newtonian Mechanics 107**
Nikolai A. Magnitskii
- Chapter 7 **Better Unification for Physics in General Through Quantum Mechanics in Particular 127**
Cynthia Kolb Whitney
- Chapter 8 **Nonrelativistic Quantum Mechanics with Fundamental Environment 161**
Ashot S. Gevorkyan
- Chapter 9 **Non Commutative Quantum Mechanics in Time - Dependent Backgrounds 187**
Antony Streklas

- Chapter 10 **Quantum Mechanics and Statistical Description of Results of Measurement** 205
Lubomír Skála and Vojtěch Kapsa
- Chapter 11 **Application of the Nikiforov-Uvarov Method in Quantum Mechanics** 225
Cüneyt Berkdemir
- Chapter 12 **Solutions for Time-Dependent Schrödinger Equations with Applications to Quantum Dots** 253
Ricardo J. Cordero-Soto
- Chapter 13 **The Group Theory and Non-Euclidean Superposition Principle in Quantum Mechanics** 263
Nicolay V. Lunin
- Chapter 14 **The Pancharatnam-Berry Phase: Theoretical and Experimental Aspects** 289
Francisco De Zela
- Chapter 15 **Bohmian Trajectories and the Path Integral Paradigm – Complexified Lagrangian Mechanics** 313
Valery I. Sbitnev
- Chapter 16 **A Fully Quantum Model of Big Bang** 341
S. P. Maydanyuk, A. Del Popolo, V. S. Olkhovsky and E. Recami
- Chapter 17 **Spontaneous Supersymmetry Breaking, Localization and Nicolai Mapping in Matrix Models** 383
Fumihiko Sugino
- Chapter 18 **Correspondences of Scale Relativity Theory with Quantum Mechanics** 409
Călin Gh. Buzea, Maricel Agop and Carmen Nejnaru
- Chapter 19 **Approximate Solutions of the Dirac Equation for the Rosen-Morse Potential in the Presence of the Spin-Orbit and Pseudo-Orbit Centrifugal Terms** 445
Kayode John Oyewumi
- Chapter 20 **Quantum Mechanics Entropy and a Quantum Version of the H-Theorem** 469
Paul Bracken
- Chapter 21 **Correction, Alignment, Restoration and Re-Composition of Quantum Mechanical Fields of Particles by Path Integrals and Their Applications** 489
Francisco Bulnes

- Chapter 22 **The ‘Computational Unified Field Theory’
(CUFT): Harmonizing Quantum and
Relativistic Models and Beyond 515**
Jonathan Bentwich
- Chapter 23 **Theoretical Validation of the
Computational Unified Field Theory (CUFT) 551**
Jonathan Bentwich

Preface

Classical physics breaks down to the level of atoms and molecules. This was made possible by the invention of a new apparatus that enabled the introduction of measurements in microscopic area of physics. There were two revolutions in the way we viewed the physical world in the twentieth century: relativity and quantum mechanics. Quantum mechanics was born in 1924, through the work of Einstein, Rutherford and Bohr, Schrödinger and Heisenberg, Born, Dirac, and many others. The principles of quantum mechanics that were discovered then are the same as we know them today. They have become the framework for thinking about most of the phenomena that physicists study, from simple systems like atoms, molecules, and nuclei to more exotic ones, like neutron stars, superfluids, and elementary particles. It is well established today that quantum mechanics, like other theories, has two aspects: the mathematical and conceptual. In the first aspect, it is a consistent and elegant theory and has been immensely successful in explaining and predicting a large number of atomic and subatomic phenomena. But in the second one, it has been a subject of endless discussions without agreed conclusions. Actually, without quantum mechanics, it was impossible to understand the enormous phenomena in microscopic physics, which does not appear in our macroscopic world. In this endless way of success for quantum mechanics, mathematics, especially mathematical physics developed to help quantum mechanics. It is believed that in order to be successful in theoretical physics, physicists should be professional mathematicians.

Although this book does not cover all areas of theoretical quantum mechanics, it can be a reference for graduate students and researchers in the international community. It contains twenty tree chapters and the brief outline of the book is as follows:

The first six chapters cover different aspects of the foundation of quantum mechanics, which is very important to understand quantum mechanics well.

Chapters seven to twenty one discuss some mathematical techniques for solving the Schrodinger differential equation that usually appears in all quantum mechanical problems.

Next two chapters of this volume are related to computational unified field theory, where the Schrodinger equation is not necessarily valid in its regular form.

This book is written by an international group of invited authors and we would like to thank all of them for their contributions to this project. I gratefully acknowledge the assistance provided by Ms. Maja Bozicevic as the Publishing Process Manager during the publishing process, and InTech publishing team for the publication of this book.

Mohammad Reza Pahlavani

Head of Nuclear Physics Department,
Mazandaran University, Mazandaran, Babolsar,
Iran

Complementarity in Quantum Mechanics and Classical Statistical Mechanics

Luisberis Velazquez Abad and Sergio Curilef Huichalaf
Departamento de Física, Universidad Católica del Norte
Chile

1. Introduction

Roughly speaking, *complementarity* can be understood as the coexistence of multiple properties in the behavior of an object that seem to be *contradictory*. Although it is possible to switch among different descriptions of these properties, in principle, it is impossible to view them, at the same time, despite their simultaneous coexistence. Therefore, the consideration of all these contradictory properties is absolutely necessary to provide a *complete characterization* of the object. In physics, complementarity represents a basic principle of *quantum theory* proposed by Niels Bohr (1; 2), which is closely identified with the *Copenhagen interpretation*. This notion refers to effects such as the so-called *wave-particle duality*. In an analogous perspective as the finite character of the speed of light c implies the impossibility of a sharp separation between the notions of *space* and *time*, the finite character of the *quantum of action* \hbar implies the impossibility of a sharp separation between the behavior of a quantum system and its interaction with the measuring instruments.

In the early days of quantum mechanics, Bohr understood that *complementarity* cannot be a unique feature of quantum theories (3; 4). In fact, he suggested that the thermodynamical quantities of temperature T and energy E should be complementary in the same way as position q and momentum p in quantum mechanics. According to thermodynamics, the energy E and the temperature T can be simultaneously defined for a thermodynamic system in equilibrium. However, a complete and different viewpoint for the energy-temperature relationship is provided in the framework of classical statistical mechanics (5). Inspired on Gibbs canonical ensemble, Bohr claimed that a *definite temperature* T can only be attributed to the system if it is submerged into a *heat bath*¹, in which case fluctuations of energy E are unavoidable. Conversely, a definite energy E can only be assigned when the system is put into *energetic isolation*, thus excluding the simultaneous determination of its temperature T .

At first glance, the above reasonings are remarkably analogous to the Bohr's arguments that support the complementary character between the coordinates \mathbf{q} and momentum \mathbf{p} . Dimensional analysis suggests the relevance of the following uncertainty relation (6):

$$\Delta E \Delta(1/T) \geq k_B, \quad (1)$$

where k_B is the Boltzmann's constant, which can play in statistical mechanics the counterpart role of the Planck's constant \hbar in quantum mechanics. Recently (7–9), we have shown that

¹ A heat bath is a huge extensive system driven by short-range forces, whose heat capacity C is so large that it can be practically regarded infinite, e.g.: the natural environment.

Bohr's arguments about the complementary character between energy and temperature, as well as the inequality of Eq.(1), are not strictly correct. However, the essential idea of Bohr is relevant enough: uncertainty relations can be present in any physical theory with a statistical formulation. In fact, *the notion of complementarity is intrinsically associated with the statistical nature of a given physical theory.*

The main interest of this chapter is to present some general arguments that support the statistical relevance of complementarity, which is illustrated in the case of classical statistical mechanics. Our discussion does not only demonstrate the existence of complementary relations involving thermodynamic variables (7-9), but also the existence of a remarkable analogy between the conceptual features of quantum mechanics and classical statistical mechanics.

This chapter is organized as follows. For comparison purposes, we shall start this discussion presenting in section 2 a general overview about the orthodox interpretation of complementarity of quantum mechanics. In section 3, we analyze some relevant *uncertainty-like inequalities* in two approaches of classical probability theory: *fluctuation theory* (5) and *Fisher's inference theory* (10; 11). These results will be applied in section 4 for the analysis of complementary relations in classical statistical mechanics. Finally, some concluding remarks and open problems are commented in section 5.

2. Complementarity in quantum mechanics: A general overview

2.1 Complementary descriptions and complementary quantities

Quantum mechanics is a theory hallmarked by the *complementarity* between two descriptions that are unified in classical physics (1; 2):

1. *Space-time description*: the parametrization in terms of coordinates \mathbf{q} and time t ;
2. *Dynamical description*: This description is based on the applicability of the *dynamical conservation laws*, where enter dynamical quantities as the energy and the momentum.

The breakdown of classical notions as the concept of *point particle trajectory* $[\mathbf{q}(t), \mathbf{p}(t)]$ was clearly evidenced in Davisson and Germer experiment and other similar experiences (12). To illustrate that electrons and other microparticles undergo *interference* and *diffraction* phenomena like the ordinary waves, in Fig.1 a schematic representation of electron interference by double-slits apparatus is shown (13). According to this experience, the *measurement results* can only be described using classical notions compatible with its corpuscular representations, that is, in terms of the *space-time description*, e.g.: a spot in a photographic plate, a recoil of some movable part of the instrument, etc. Moreover, these experimental results are generally *unpredictable*, that is, they show an intrinsic *statistical nature* that is governed by the wave behavior dynamics. According to these experiments, there is no a sharp separation between the *undulatory-statistical* behavior of microparticles and the space-time description associated with the interaction with the measuring instruments.

Besides the existence of complementary descriptions, it is possible to talk about the notion of *complementary quantities*. Position \mathbf{q} and momentum \mathbf{p} , as well as time t and energy E , are relevant examples complementary quantities. Any experimental setup aimed to study the exchange of energy E and momentum \mathbf{p} between microparticles must involve a measure in a finite region of the space-time for the definition of wave frequency ω and vector \mathbf{k} entering in *de Broglie's relations* (14):

$$E = \hbar\omega \text{ and } \mathbf{p} = \hbar\mathbf{k}. \quad (2)$$

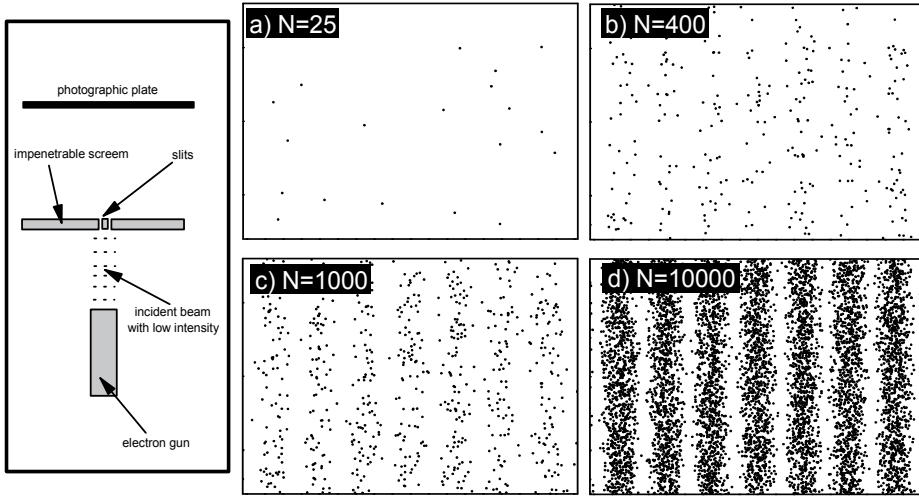

Fig. 1. Schematic representation of electron interference by double-slit apparatus using an incident beam with low intensity. Sending electrons through a double-slit apparatus one at a time results in single *spot* appearing on the photographic plate. However, an interference pattern progressively emerges when the number N of electrons impacted on the plate is increased. The emergence of an interference pattern suggested that each electron was *interfering with itself*, and therefore in some sense the electron had to be going through both slits at once. Clearly, this interpretation contradicts the classical notion of particles trajectory.

Conversely, any attempt of locating the collision between microparticles in the space-time more accurately would exclude a precise determination in regards the balance of momentum \mathbf{p} and energy E . Quantitatively, such complementarity is characterized in terms of *uncertainty relations* (2):

$$\Delta q \Delta p \geq \hbar \text{ and } \Delta t \Delta E \geq \hbar, \quad (3)$$

which are associated with the known *Heisenberg's uncertainty principle*: if one tries to describe the dynamical state of a microparticle by methods of classical mechanics, then precision of such description is limited. In fact, the classical state of microparticle turns out to be badly defined. While the coordinate-momentum uncertainty forbids the classical notion of trajectory, the energy-time uncertainty accounts for that a state, existing for a short time Δt , cannot have a definite energy E .

2.2 Principles of quantum mechanics

2.2.1 The wave function Ψ and its physical relevance

Dynamical description of a quantum system is performed in terms of the so-called the *wave function* Ψ (12). For example, such as the frequency ω and wave vector \mathbf{k} observed in electron diffraction experiments are related to dynamical variables as energy E and momentum \mathbf{p} in terms of de Broglie's relations (2). Accordingly, the wave function $\Psi(\mathbf{q}, t)$ associated with a *free microparticle* (as the electrons in a beam with very low intensity) behaves as follows:

$$\Psi(\mathbf{q}, t) = C \exp[-i(Et - \mathbf{p} \cdot \mathbf{q})/\hbar]. \quad (4)$$

Historically, de Broglie proposed the relations (2) as a direct generalization of quantum hypothesis of light developed by Planck and Einstein for any kind of microparticles (14). The

experimental confirmation of these wave-particle duality for any kind of matter revealed the unity of material world. In fact, wave-particle duality is a property of matter as universal as the fact that any kind of matter is able to produce a gravitational interaction.

While the *state* of a system in classical mechanics is determined by the knowledge of the positions \mathbf{q} and momenta \mathbf{p} of all its constituents, the state of a system in the framework of quantum mechanics is determined by the knowledge of its wave function $\Psi(\mathbf{q}, t)$ (or its generalization $\Psi(\mathbf{q}^1, \mathbf{q}^2, \dots, \mathbf{q}^n, t)$ for a system with many constituents, notation that is omitted hereafter for the sake of simplicity). In fact, the knowledge of the wave function $\Psi(\mathbf{q}, t_0)$ in an initial instant t_0 allows the prediction of its future evolution prior to the realization of a measurement (12). The wave function $\Psi(\mathbf{q}, t)$ is a complex function whose modulus $|\Psi(\mathbf{q}, t)|^2$ describes the *probability density*, in an absolute or relative sense, to detect a microparticle at the position \mathbf{q} as a result of a *measurement* at the time t (15). Such a statistical relevance of the wave function $\Psi(\mathbf{q}, t)$ about its relation with the experimental results is the most condensed expression of complementarity of quantum phenomena.

Due to its statistical relevance, the reconstruction of the wave function $\Psi(\mathbf{q}, t)$ from a given experimental situation demands the notion of *statistical ensemble* (12). In electron diffraction experiments, each electron in the beam manifests undulatory properties in its dynamical behavior. However, the interaction of this microparticle with a measuring instrument (a classical object as a photographic plate) radically affects its initial state, e.g.: electron is forced to localize in a very narrow region (the spot). In this case, a single measuring process is useless to reveal the wave properties of its previous quantum state. To rebuild the wave function Ψ (up to the precision of an unimportant constant complex factor $e^{i\phi}$), it is necessary to perform *infinite repeated measurements* of the quantum system under the *same initial conditions*. Abstractly, this procedure is equivalent to consider simultaneous measurements over a *quantum statistical ensemble*: such as an infinite set of identical copies of the quantum system, which have been previously prepared under the same experimental procedure². Due to the important role of measurements in the knowledge state of quantum systems, *quantum mechanics is a physical theory that allows us to predict the results of certain experimental measurements taken over a quantum statistical ensemble that it has been previously prepared under certain experimental criteria* (12).

2.2.2 The superposition principle

To explain interference phenomena observed in the double-slit experiments, the wave function $\Psi(\mathbf{q}, t)$ of a quantum system should satisfy the *superposition principle* (12):

$$\Psi(\mathbf{q}, t) = \sum_{\alpha} a_{\alpha} \Psi_{\alpha}(\mathbf{q}, t). \quad (5)$$

Here, $\Psi_{\alpha}(\mathbf{q}, t)$ represents the normalized wave function associated with the α -th independent state. As example, $\Psi_{\alpha}(\mathbf{q}, t)$ could represent the wave function contribution associated with each slit during electron interference experiments; while the modulus $|a_{\alpha}|^2$ of the complex amplitudes a_{α} are proportional to incident beam intensities I_{α} , or equivalently, the probability p_{α} that a given electron crosses through the α -th slit.

² This ensemble definition corresponds to the so-called *pure quantum state*, whose description is performed in terms of the wave function Ψ . A more general extension is the mixed statistical ensemble that corresponds to the so-called *mixed quantum state*, whose description is performed in terms of the *density matrix* $\hat{\rho}$. The consideration of the density matrix is the natural description of quantum statistical mechanics.

Superposition principle is the most important hypothesis with a positive content of quantum theory. In particular, it evidences that dynamical equations of the wave function $\Psi(\mathbf{q}, t)$ should exhibit a *linear character*. By itself, the superposition principle allows to assume linear algebra as the mathematical apparatus of quantum mechanics. Thus, the wave function $\Psi(\mathbf{q}, t)$ can be regarded as a complex vector in a *Hilbert space* \mathcal{H} . Under this interpretation, the superposition formula (5) can be regarded as a decomposition of a vector Ψ in a basis of independent vectors $\{\Psi_\alpha\}$. The normalization of the wave function Ψ can be interpreted as the *vectorial norm*:

$$\|\Psi\|^2 = \int \Psi^*(\mathbf{q}, t)\Psi(\mathbf{q}, t)d\mathbf{q} = \sum_{\alpha\beta} g_{\alpha\beta} a_\alpha^* a_\beta = 1. \quad (6)$$

Here, the matrix elements $g_{\alpha\beta}$ denote the *scalar product* (complex) between different basis elements:

$$g_{\alpha\beta} = \int \Psi_\alpha^*(\mathbf{q}, t)\Psi_\beta(\mathbf{q}, t)d\mathbf{q}, \quad (7)$$

which accounts for the existence of interference effects during the experimental measurements. As expected, the interference matrix, $g_{\alpha\beta}$, is a hermitian matrix, $g_{\alpha\beta} = g_{\beta\alpha}^*$. The basis $\{\Psi_\alpha(\mathbf{q}, t)\}$ is said to be *orthonormal* if their elements satisfy *orthogonality condition*:

$$\int \Psi_\alpha^*(\mathbf{q}, t)\Psi_\beta(\mathbf{q}, t)d\mathbf{q} = \delta_{\alpha\beta}, \quad (8)$$

where $\delta_{\alpha\beta}$ represents Kroneker delta (for a basis with discrete elements) or a Dirac delta functions (for the basis with continuous elements). The basis of independent states is *complete* if any admissible state $\Psi \in \mathcal{H}$ can be represented with this basis. In particular, a basis with independent orthogonal elements is complete if it satisfies the *completeness condition*:

$$\sum_{\alpha} \Psi_\alpha^*(\tilde{\mathbf{q}}, t)\Psi_\alpha(\mathbf{q}, t) = \delta(\tilde{\mathbf{q}} - \mathbf{q}). \quad (9)$$

2.2.3 The correspondence principle

Other important hypothesis of quantum mechanics is the *correspondence principle*. We assume the following suitable statement: the wave-function $\Psi(\mathbf{q}, t)$ can be approximated in the *quasi-classic limit* $\hbar \rightarrow 0$ as follows (12):

$$\Psi(\mathbf{q}, t) \sim \exp [iS(\mathbf{q}, t)/\hbar], \quad (10)$$

where $S(\mathbf{q}, t)$ is the classical action of the system associated with the known Hamilton-Jacobi theory of classical mechanics. Physically, this principle expresses that quantum mechanics contains classical mechanics as an asymptotic theory. At the same time, it states that quantum mechanics should be formulated under the correspondence with classical mechanics. Physically speaking, it is impossible to introduce a consistent quantum mechanics formulation without the consideration of classical notions. Precisely, this is a very consequence of the complementarity between the dynamical description performed in terms of the wave function Ψ and the *space-time classical description* associated with the results of experimental measurements. The completeness of quantum description performed in terms of the wave function Ψ demands both the presence of quantum statistical ensemble and classical objects that play the role of measuring instruments.

Historically, correspondence principle was formally introduced by Bohr in 1920 (16), although he previously made use of it as early as 1913 in developing his model of the atom

(17). According to this principle, quantum description should be consistent with classical description in the limit of large quantum numbers. In the framework of Schrödinger's wave mechanics, this principle appears as a suitable generalization of the so-called *optics-mechanical analogy* (18). In geometric optics, the light propagation is described in the so-called rays approximation. According to the *Fermat's principle*, the ray trajectories extremize the optical length $\ell[\mathbf{q}(s)]$:

$$\ell[\mathbf{q}(s)] = \int_{s_1}^{s_2} n[\mathbf{q}(s)] ds \rightarrow \delta\ell[\mathbf{q}(s)] = 0, \quad (11)$$

which is calculated along the curve $\mathbf{q}(s)$ with fixed extreme points $\mathbf{q}(s_1) = P$ and $\mathbf{q}(s_2) = Q$. Here, $n(\mathbf{q})$ is the refraction index of the optical medium and $ds = |d\mathbf{q}|$. Equivalently, the rays propagation can be described by *Eikonal equation*:

$$|\nabla\varphi(\mathbf{q})|^2 = k_0^2 n^2(\mathbf{q}), \quad (12)$$

where $\varphi(\mathbf{q})$ is the phase of the undulatory function $u(\mathbf{q}, t) = a(\mathbf{q}, t) \exp[-i\omega t + i\varphi(\mathbf{q})]$ in the wave optics, $k_0 = \omega/c$ and c are the modulus of the wave vector and the speed of light in vacuum, respectively. The phase $\varphi(\mathbf{q})$ allows to obtain the wave vector $\mathbf{k}(\mathbf{q})$ within the optical medium:

$$\mathbf{k}(\mathbf{q}) = \nabla\varphi(\mathbf{q}) \rightarrow k(\mathbf{q}) = |\mathbf{k}(\mathbf{q})| = k_0 n(\mathbf{q}), \quad (13)$$

which provides the orientation of the ray propagation:

$$\frac{d\mathbf{q}(s)}{ds} = \frac{\mathbf{k}(\mathbf{q})}{|\mathbf{k}(\mathbf{q})|}. \quad (14)$$

Equation (12) can be derived from the wave equation:

$$n^2(\mathbf{q}) \frac{\partial^2}{c^2 \partial t^2} u(\mathbf{q}, t) = \nabla^2 u(\mathbf{q}, t) \quad (15)$$

considering the approximations $|\partial^2 a(\mathbf{q}, t)/\partial t^2| \ll \omega^2 |a(\mathbf{q}, t)|$ and $|\nabla^2 a(\mathbf{q}, t)| \ll k^2(\mathbf{q}) |a(\mathbf{q}, t)|$. Remarkably, Eikonal equation (12) is equivalent in the mathematical sense to the Hamilton-Jacobi equation for a conservative mechanical system:

$$\frac{1}{2m} |\nabla W(\mathbf{q})|^2 = E - V(\mathbf{q}), \quad (16)$$

where $W(\mathbf{q})$ is the reduced action that appears in the classical action $S(\mathbf{q}, t) = W(\mathbf{q}) - Et$. Analogously, Fresnel's principle is a counterpart of *Maupertuis' principle*:

$$\delta \int \sqrt{2m[E - V(\mathbf{q})]} ds = 0. \quad (17)$$

In quantum mechanics, the optics-mechanics analogy suggests the way that quantum theory asymptotically drops to classical mechanics in the limit $\hbar \rightarrow 0$. Specifically, the total phase $\varphi(\mathbf{q}, t) = \varphi(\mathbf{q}) - \omega t$ of the wave function $\Psi(\mathbf{q}, t) \sim \exp[i\varphi(\mathbf{q}, t)]$ should be proportional to the classical action of Hamilton-Jacobi theory, $\varphi(\mathbf{q}, t) \sim S(\mathbf{q}, t)/\hbar$, consideration that leads to expression (10).

2.2.4 Operators of physical observables and Schrödinger equation

Physical interpretation of the wave function $\Psi(\mathbf{q}, t)$ implies that the expectation value of any arbitrary function $A(\mathbf{q})$ that is defined on the space coordinates \mathbf{q} is expressed as follows:

$$\langle A \rangle = \int |\Psi(\mathbf{q}, t)|^2 A(\mathbf{q}) d\mathbf{q}. \quad (18)$$

For calculating the expectation value of an arbitrary physical observable O , the previous expression should be extended to a *bilinear form* in term of the wave function $\Psi(\mathbf{q}, t)$ (19):

$$\langle O \rangle = \int \Psi^*(\mathbf{q}, t) O(\mathbf{q}, \tilde{\mathbf{q}}, t) \Psi(\tilde{\mathbf{q}}, t) d\mathbf{q} d\tilde{\mathbf{q}}, \quad (19)$$

where $O(\mathbf{q}, \tilde{\mathbf{q}}, t)$ is the kernel of the physical observable O . As already commented, there exist some physical observables, e.g.: the momentum \mathbf{p} , whose determination demands repetitions of measurements in a finite region of the space sufficient for the manifestation of wave properties of the function $\Psi(\mathbf{q}, t)$. Precisely, this type of procedure involves a comparison or correlation between different points of the space $(\mathbf{q}, \tilde{\mathbf{q}})$, which is accounted for by the kernel $O(\mathbf{q}, \tilde{\mathbf{q}}, t)$. Due to the expectation value of any physical observable O is a real number, the kernel $O(\mathbf{q}, \tilde{\mathbf{q}}, t)$ should obey the *hermitian condition*:

$$O^*(\tilde{\mathbf{q}}, \mathbf{q}, t) = O(\mathbf{q}, \tilde{\mathbf{q}}, t). \quad (20)$$

As commented before, superposition principle (5) has naturally introduced the linear algebra on a Hilbert space \mathcal{H} as the mathematical apparatus of quantum mechanics. Using the decomposition of the wave function Ψ into a certain basis $\{\Psi_\alpha\}$, it is possible to obtain the following expressions:

$$\langle O \rangle = \sum_{\alpha\beta} a_\alpha^* O_{\alpha\beta} a_\beta, \quad (21)$$

where:

$$O_{\alpha\beta} = \int \Psi_\alpha^*(\mathbf{q}, t) O(\mathbf{q}, \tilde{\mathbf{q}}, t) \Psi_\beta(\tilde{\mathbf{q}}, t) d\tilde{\mathbf{q}} d\mathbf{q}. \quad (22)$$

Notice that hermitian condition (20) implies the hermitian character of operator matrix elements, $O_{\beta\alpha}^* = O_{\alpha\beta}$. The application of the kernel $O(\mathbf{q}, \tilde{\mathbf{q}}, t)$ over a wave function $\Psi(\mathbf{q}, t)$:

$$\Phi(\mathbf{q}, t) = \int O(\mathbf{q}, \tilde{\mathbf{q}}, t) \Psi(\tilde{\mathbf{q}}, t) d\tilde{\mathbf{q}} \quad (23)$$

yields a new vector $\Phi(\mathbf{q}, t)$ of the Hilbert space, $\Phi(\mathbf{q}, t) \in \mathcal{H}$. Formally, this operation is equivalent to associate each physical observable O with a *linear operator* \hat{O} :

$$\hat{O} \left(\sum_\alpha a_\alpha \Psi_\alpha \right) = \sum_\alpha a_\alpha \hat{O} \Psi_\alpha, \quad (24)$$

where:

$$\hat{O} \Psi(\mathbf{q}, t) \equiv \int O(\mathbf{q}, \tilde{\mathbf{q}}, t) \Psi(\tilde{\mathbf{q}}, t) d\tilde{\mathbf{q}}. \quad (25)$$

This last notation convention allows to rephrase expression (19) for calculating the physical expectation values into the following familiar form:

$$\langle O \rangle = \int \Psi^*(\mathbf{q}, t) \hat{O} \Psi(\mathbf{q}, t) d\mathbf{q}. \quad (26)$$

The application of the physical operator \hat{O} on any element Ψ_β of the orthonormal basis, $\{\Psi_\alpha\}$, can be decomposed into the same basis:

$$\hat{O}\Psi_\beta = \sum_\alpha O_{\alpha\beta}\Psi_\alpha. \quad (27)$$

Moreover, the kernel $O(\tilde{\mathbf{q}}, \mathbf{q}, t)$ can be expressed in this orthonormal basis as follows:

$$O(\tilde{\mathbf{q}}, \mathbf{q}, t) = \sum_{\alpha\beta} \Psi_\alpha(\tilde{\mathbf{q}}, t) O_{\alpha\beta} \Psi_\beta^*(\mathbf{q}, t). \quad (28)$$

Denoting by $T_{m\alpha}$ the transformation matrix elements from the basis $\{\Psi_\alpha\}$ to a new basis $\{\Psi_m\}$:

$$\Psi_\alpha = \sum_m T_{m\alpha} \Psi_m, \quad (29)$$

the operator matrix elements O_{mn} in this new basis can be expressed as follows:

$$O_{mn} = \sum_{\alpha\beta} T_{m\alpha} O_{\alpha\beta} T_{\beta n}^{-1}. \quad (30)$$

Using an appropriate transformation, the operator matrix elements can be expressed into a diagonal form: $O_{mn} = O_m \delta_{mn}$. Such a basis can be regarded as the *proper representation* of the physical operator \hat{O} , which corresponds to the eigenvalues problem:

$$\hat{O}\Psi_m(\mathbf{q}, t) = O_m \Psi_m(\mathbf{q}, t). \quad (31)$$

The eigenvalues O_m conform the *spectrum* of the physical operator \hat{O} , that is, its admissible values observed in the experiment. On the other hand, the set of eigenfunctions $\{\Psi_m\}$ can be used to introduce a basis in the Hilbert space \mathcal{H} , whenever it represents a complete set of functions. Using this basis of eigenfunctions, it is possible to obtain some remarkable results. For example, the expectation value of physical observable O can be expressed into the ordinary expression:

$$\langle O \rangle = \sum_m O_m p_m, \quad (32)$$

where $p_m = |a_m|^2$ is the probability of the m -th eigenstate. Using the hermitian character of any physical operator $\hat{O}^+ = \hat{O}$, it is possible to obtain the following result:

$$(O_m - O_n) \int \Psi_m^*(\mathbf{q}, t) \Psi_n(\mathbf{q}, t) d\mathbf{q} = 0. \quad (33)$$

If $O_m \neq O_n$, the corresponding eigenfunctions $\Psi_m(\mathbf{q}, t)$ and $\Psi_n(\mathbf{q}, t)$ are *orthogonal*. Additionally, if two physical operators \hat{A} and \hat{B} possesses the same spectrum of eigenfunctions, the commutator of these operators:

$$[\hat{A}, \hat{B}] = \hat{A}\hat{B} - \hat{B}\hat{A} \quad (34)$$

identically vanishes:

$$[\hat{A}, \hat{B}] = 0. \quad (35)$$

Such an operational identity is shown as follows. Considering a general function $\Psi \in \mathcal{H}$ and its representation using the complete orthonormal basis $\{\Psi_m\}$:

$$\Psi = \sum_m a_m \Psi_m, \quad (36)$$

one obtains the following relation:

$$[\hat{A}, \hat{B}]\Psi = \sum_m a_m (\hat{A}\hat{B} - \hat{B}\hat{A})\Psi_m = \sum_m a_m (A_m B_m - B_m A_m)\Psi_m = 0. \quad (37)$$

Clearly, a complete orthonormal basis $\{\Psi_m\}$ in the Hilbert space \mathcal{H} is conformed by the eigenfunctions of all admissible and independent physical operators that commute among them.

According to expression (18), the operators of spatial coordinates \mathbf{q} and their functions $A(\mathbf{q})$ are simply given by these coordinates, $\hat{\mathbf{q}} = \mathbf{q}$ and $\hat{A}(\mathbf{q}) = A(\mathbf{q})$. The introduction of physical operators in quantum mechanics is precisely based on the correspondence with classical mechanics. Relevant examples are the physical operators of energy and momentum (19):

$$\hat{E} = i\hbar \frac{\partial}{\partial t} \text{ and } \hat{\mathbf{p}} = -i\hbar \nabla. \quad (38)$$

Clearly, the wave function of the free microparticle (4) is just the eigenfunction of these operators. Using the quasi-classical expression of the wave function (10), these operators drop to their classical definitions in the Hamilton-Jacobi theory (18):

$$\hat{\mathbf{p}}\Psi(\mathbf{q}, t) \sim \hat{\mathbf{p}} \exp[iS(\mathbf{q}, t)/\hbar] \Rightarrow \mathbf{p} = \nabla S(\mathbf{q}, t), \quad (39)$$

$$\hat{E}\Psi(\mathbf{q}, t) \sim \hat{E} \exp[iS(\mathbf{q}, t)/\hbar] \Rightarrow -\frac{\partial}{\partial t} S(\mathbf{q}, t) = H(\mathbf{q}, \mathbf{p}, t), \quad (40)$$

where $H(\mathbf{q}, \mathbf{p}, t)$ is the Hamiltonian, which represents the energy E in the case of a conservative mechanical system $H(\mathbf{q}, \mathbf{p}, t) = H(\mathbf{q}, \mathbf{p}) = E$. In the framework of Hamilton-Jacobi theory, the system dynamics is described by the following equation:

$$\frac{\partial}{\partial t} S(\mathbf{q}, t) + H(\mathbf{q}, \nabla S(\mathbf{q}, t), t). \quad (41)$$

Its quantum mechanics counterpart is the well-known *Schrödinger equation* (19):

$$i\hbar \frac{\partial}{\partial t} \Psi(\mathbf{q}, t) = \hat{H}\Psi(\mathbf{q}, t) \quad (42)$$

where $\hat{H} = H(\mathbf{q}, \hat{\mathbf{p}}, t)$ is the corresponding operator of the system Hamiltonian.

2.3 Derivation of complementary relations

Let us introduce the scalar z-product between two arbitrary vectors Ψ_1 and Ψ_2 of the Hilbert space \mathcal{H} :

$$\Psi_1 \otimes_z \Psi_2 = \frac{1}{2} z \langle \Psi_1 | \Psi_2 \rangle + \frac{1}{2} z^* \langle \Psi_2 | \Psi_1 \rangle, \quad (43)$$

where $\langle \Psi_1 | \Psi_2 \rangle$ denotes:

$$\langle \Psi_1 | \Psi_2 \rangle \equiv \int \Psi_1^*(\mathbf{q}, t) \Psi_2(\mathbf{q}, t) d\mathbf{q}. \quad (44)$$

The scalar z-product is always real for any Ψ_1 and $\Psi_2 \in \mathcal{H}$ and obeys the following properties:

1. *Linearity*:

$$\Psi \otimes_z (\Psi_1 + \Psi_2) = \Psi \otimes_z \Psi_1 + \Psi \otimes_z \Psi_2, \quad (45)$$

2. *Homogeneity*:

$$\Psi_1 \otimes_z (w\Psi_2) = \Psi_1 \otimes_{zw} \Psi_2, \quad (46)$$

3. *z-Symmetry*:

$$\Psi_1 \otimes_z \Psi_2 = \Psi_2 \otimes_{z^*} \Psi_1 \quad (47)$$

4. *Nonnegative definition*: if $\Re(z) > 0$ then:

$$\Psi \otimes_z \Psi \geq 0 \text{ and } \Psi \otimes_z \Psi = 0 \Rightarrow \Psi = 0. \quad (48)$$

Denoting as $\Psi_1 \otimes \Psi_2$ the case $z = 1$, it is easy to obtain the following relation:

$$\Psi \otimes_z \Psi = \Re(z)\Psi \otimes \Psi = \Re(z) \|\Psi\|^2, \quad (49)$$

where $\|\Psi\|^2 = \langle \Psi | \Psi \rangle$ denotes the *norm of the vector* $\Psi \in \mathcal{H}$. Considering $w = |w|e^{i\phi}$, the inequality

$$(\Psi_1 + w\Psi_2) \otimes (\Psi_1 + w\Psi_2) \geq 0 \quad (50)$$

can be rewritten as follows:

$$\Psi_1 \otimes \Psi_1 + |w|^2 \Psi_2 \otimes \Psi_2 + 2|w| \Psi_1 \otimes_{e^{i\phi}} \Psi_2 \geq 0. \quad (51)$$

The nonnegative definition of the previous expression demands the applicability of the following inequality:

$$\|\Psi_1\|^2 \|\Psi_2\|^2 \geq \left(\Psi_1 \otimes_{e^{i\phi}} \Psi_2 \right)^2, \quad (52)$$

which represents a special form of the Cauchy-Schwartz inequality. Considering two physical operators \hat{A} and \hat{B} with vanishing expectation values $\langle A \rangle = \langle B \rangle = 0$, and considering $\Psi_1 = \hat{A}\Psi$ and $\Psi_2 = \hat{B}\Psi$, it is possible to obtain the following expression:

$$\Psi_1 \otimes_{e^{i\phi}} \Psi_2 = \frac{1}{2} \cos \phi \langle C_A \rangle - \frac{1}{2} \sin \phi \langle C \rangle, \quad (53)$$

where $\langle C_A \rangle$ and $\langle C \rangle$ are the expectation values of physical operators \hat{C}_A and \hat{C} :

$$\hat{C}_A = \{\hat{A}, \hat{B}\} = \hat{A}\hat{B} + \hat{B}\hat{A} \text{ and } i\hat{C} = [\hat{A}, \hat{B}] = \hat{A}\hat{B} - \hat{B}\hat{A}. \quad (54)$$

Introducing the *statistical uncertainty* $\Delta O = \sqrt{\langle (O - \langle O \rangle)^2 \rangle}$ of the physical observable O , inequality (52) can be rewritten as follows:

$$\Delta A \Delta B \geq \frac{1}{2} |\cos \phi \langle C_A \rangle - \sin \phi \langle C \rangle|. \quad (55)$$

Relevant particular cases of the previous result are the following inequalities:

$$\Delta A \Delta B \geq \frac{1}{2} |\langle C_A \rangle|, \quad \Delta A \Delta B \geq \frac{1}{2} |\langle C \rangle|, \quad (56)$$

$$\Delta A \Delta B \geq \frac{1}{2} \sqrt{\langle C_A \rangle^2 + \langle C \rangle^2}. \quad (57)$$

Accordingly, the product of statistical uncertainties of two physical observables A and B are inferior bounded by the commutator \hat{C} , or the anti-commutator \hat{C}_A of their respective operators. The commutator form of Eq.(56) was firstly obtained by Robertson in 1929 (20), who generalizes a particular result derived by Kennard (21):

$$\Delta q^i \Delta p_i \geq \frac{1}{2} \hbar, \quad (58)$$

using the commutator relations:

$$[\hat{q}^i, \hat{p}_j] = i\delta_j^i \hbar. \quad (59)$$

The inequality of Eq.(57) was finally obtained by Schrödinger (22) and it is now referred to as *Robertson-Schrodinger inequality*. Historically, Kennard's result in (58) was the first rigorous mathematical demonstration about the uncertainty relation between coordinates and momentum, which provided evidences that *Heisenberg's uncertainty relations* can be obtained as direct consequences of statistical character of the algebraic apparatus of quantum mechanics.

3. Relevant inequalities in classical probability theory

Hereafter, let us consider a generic classical distribution function:

$$dp(I|\theta) = \rho(I|\theta)dI \quad (60)$$

where $I = (I^1, I^2, \dots, I^n)$ denotes a set of continuous stochastic variables driven by a set $\theta = (\theta^1, \theta^2, \dots, \theta^m)$ of the control parameters. Let us denote by \mathcal{M}_θ the compact manifold constituted by all admissible values of the variables I that are accessible for a fixed $\theta \in \mathcal{P}$, where \mathcal{P} is the compact manifold of all admissible values of control parameters θ . Moreover, let us admit that the probability density $\rho(I|\theta)$ obeys some general mathematical conditions as normalization, differentiability, as well as regular boundary conditions as:

$$\lim_{I \rightarrow I_b} \rho(I|\theta) = \lim_{I \rightarrow I_b} \frac{\partial}{\partial I^i} \rho(I|\theta) = 0, \quad (61)$$

where I_b is any point located at the boundary $\partial\mathcal{M}_\theta$ of the manifold \mathcal{M}_θ . The parametric family of distribution functions of Eq.(60) can be analyzed by two different perspectives:

- The study of fluctuating behavior of stochastic variables $I \in \mathcal{M}_\theta$, which is the main interest of *fluctuation theory*;
- The analysis of the relationship between this fluctuating behavior and the external influence described in terms of parameters $\theta \in \mathcal{P}$, which is the interest of *inference theory*.

3.1 Fluctuation theory

The probability density $\rho(I|\theta)$ can be employed to introduce the *generalized differential forces* $\eta_i(I|\theta)$ as follows (8; 9):

$$\eta_i(I|\theta) = -\frac{\partial}{\partial I^i} \log \rho(I|\theta). \quad (62)$$

By definition, the quantities $\eta_i(I|\theta)$ vanish in those stationary points \bar{I} where the probability density $\rho(I|\theta)$ exhibits its local maxima or its local minima. In statistical mechanics, the global (local) maximum of the probability density is commonly regarded as a stable (metastable)

equilibrium configuration. These notable points can be obtained from the maximization of the logarithm of the probability density $\rho(I|\theta)$, which leads to the following *stationary and stability equilibrium conditions*:

$$\eta_i(\bar{I}|\theta) = 0, \text{ and } \frac{\partial}{\partial \bar{I}^i} \eta_j(\bar{I}|\theta) \succ 0, \quad (63)$$

where the notation $A_{ij} \succ 0$ indicates the positive definition of the matrix A_{ij} . In general, the differential generalized forces $\eta_i(I|\theta)$ characterize the deviation of a given point $I \in \mathcal{M}_\theta$ from these local equilibrium configurations. As stochastic variables, the differential generalized forces $\eta_i(I|\theta)$ obey the following fluctuation theorems (8; 9):

$$\langle \eta_i(I|\theta) \rangle = 0, \left\langle \frac{\partial}{\partial I^i} \eta_j(I|\theta) \right\rangle = \langle \eta_i(I|\theta) \eta_j(I|\theta) \rangle, \left\langle \eta_i(I|\theta) \delta I^j \right\rangle = \delta_i^j, \quad (64)$$

where δ_i^j is the Kronecker delta. These fluctuation theorems are directly derived from the following identity:

$$\left\langle \frac{\partial}{\partial I^i} A(I|\theta) \right\rangle = \langle \eta_i(I|\theta) A(I|\theta) \rangle \quad (65)$$

substituting the cases $A(I|\theta) = 1, I^i$ and η_i , respectively. Here, $A(I)$ is a differentiable function defined on the continuous variables I with definite expectation values $\langle \partial A(I|\theta) / \partial I^i \rangle$ that obeys the following boundary condition:

$$\lim_{I \rightarrow I_b} A(I) \rho(I|\theta) = 0. \quad (66)$$

Moreover, equation (65) follows from the integral expression:

$$\int_{\mathcal{M}_\theta} \frac{\partial v^j(I|\theta)}{\partial I^i} \rho(I|\theta) dI = - \int_{\mathcal{M}_\theta} v^j(I|\theta) \frac{\partial \rho(I|\theta)}{\partial I^i} dI + \oint_{\partial \mathcal{M}_\theta} \rho(I|\theta) v^j(I|\theta) \cdot d\Sigma_j,$$

that is derived from the *intrinsic exterior calculus* of the manifold \mathcal{M}_θ and the imposition of the constraint $v^j(I|\theta) \equiv \delta_i^j A(I|\theta)$. Since the self-correlation matrix $M_{ij}(\theta) = \langle \eta_i(I|\theta) \eta_j(I|\theta) \rangle$ is always a positive definite matrix, the first and second identities are counterpart expressions of the stationary and stability equilibrium conditions of Eq.(63) in the form of statistical expectation values. The third identity shows the statistical independence among the variable I^i and a generalized differential force component $\eta_j(I|\theta)$ with $j \neq i$, as well as the existence of a certain *statistical complementarity* between I^i and its conjugated generalized differential force $\eta_i(I|\theta)$. Using the Cauchy-Schwartz inequality $\langle \delta x \delta y \rangle^2 \leq \langle \delta x^2 \rangle \langle \delta y^2 \rangle$, one obtains the following *uncertainty-like relation* (8; 9):

$$\Delta I^i \Delta \eta_i \geq 1, \quad (67)$$

where $\Delta x = \sqrt{\langle \delta x^2 \rangle}$ denotes the standard deviation of the quantity x . The previous result is improved by the following inequality:

$$\langle \delta I^i \delta I^j \rangle - M^{ij}(\theta) \succ 0, \quad (68)$$

which puts a lower bound to the self-correlation matrix $C^{ij} = \langle \delta I^i \delta I^j \rangle$ of the stochastic variables I . This result can be directly obtained from the positive definition of the self-correlation matrix $Q^{ij}(\theta) = \langle \delta q^i \delta q^j \rangle$, where $\delta q^i = \delta I^i - M^{ij}(\theta)\eta_j(I|\theta)$, with $M^{ij}(\theta)$ being the inverse of the self-correlation matrix $M_{ij}(\theta) = \langle \eta_i(I|\theta)\eta_j(I|\theta) \rangle$.

3.2 Inference theory

Inference theory addresses the problem of deciding how well a set of outcomes $\mathcal{I} = (I_1, I_2, \dots, I_s)$, which is obtained from s independent measurements, fits to a proposed probability distribution $d\rho(I|\theta) = \rho(I|\theta)dI$. If the probability distribution is characterized by one or more parameters $\theta = (\theta^1, \theta^2, \dots, \theta^m)$, this problem is equivalent to infer their values from the observed outcomes I . To make inferences about the parameters θ , one constructs estimators, i.e., functions $\hat{\theta}^\alpha(\mathcal{I}) = \hat{\theta}^\alpha(I_1, I_2, \dots, I_s)$ of the outcomes of m independent repeated measurements (10; 11). The values of these functions represent the best guess for θ . Commonly, there exist several criteria imposed on estimators to ensure that their values constitute good estimates for θ , such as unbiasedness, $\langle \hat{\theta}^\alpha \rangle = \theta^\alpha$, efficiency, $\langle (\hat{\theta}^\alpha - \theta^\alpha)^2 \rangle \rightarrow \text{minimum}$, etc. One of the most popular estimators employed in practical applications are the maximal likelihood estimators $\hat{\theta}_{ml}$ (10), which are obtained introducing the likelihood function:

$$\varrho(\mathcal{I}|\theta) = \rho(I_1|\theta)\rho(I_2|\theta)\dots\rho(I_m|\theta) \quad (69)$$

and demanding the condition $\varrho(\mathcal{I}|\hat{\theta}_{ml}) \rightarrow \text{maximum}$. This procedure leads to the following stationary and stability conditions:

$$v_\alpha(\mathcal{I}|\hat{\theta}_{ml}) = 0, \quad \frac{\partial}{\partial \theta^\alpha} v_\beta(\mathcal{I}|\hat{\theta}_{ml}) \succ 0. \quad (70)$$

where the quantities $v_\alpha(\mathcal{I}|\theta)$ are referred to in the literature as the *score vector components*:

$$v_\alpha(\mathcal{I}|\theta) = -\frac{\partial}{\partial \theta^\alpha} \log \varrho(\mathcal{I}|\theta). \quad (71)$$

As stochastic quantities, the score vector components $v_\alpha(\mathcal{I}|\theta)$ obey the following identities:

$$\langle v_\alpha(\mathcal{I}|\theta) \rangle = 0, \quad \left\langle \frac{\partial}{\partial \theta^\alpha} v_\beta(\mathcal{I}|\theta) \right\rangle = \langle v_\alpha(\mathcal{I}|\theta)v_\beta(\mathcal{I}|\theta) \rangle, \quad \langle \hat{\theta}^\alpha(\mathcal{I})v_\beta(\mathcal{I}|\theta) \rangle = -\delta_{\beta}^{\alpha}, \quad (72)$$

where $\hat{\theta}^\alpha(\mathcal{I})$ represents an unbiased estimator for the α -th parameter θ^α . Moreover, expectation values $\langle A(\mathcal{I}) \rangle$ are defined as follows:

$$\langle A(\mathcal{I}) \rangle = \int_{\mathcal{M}_\theta^s} A(\mathcal{I})\varrho(\mathcal{I}|\theta)d\mathcal{I}, \quad (73)$$

where $d\mathcal{I} = \prod_i dI_i$ and $\mathcal{M}_\theta^s = \mathcal{M}_\theta \otimes \mathcal{M}_\theta \dots \mathcal{M}_\theta$ (s times the external product of the manifold \mathcal{M}_θ). The fluctuation expressions (72) are derived from the mathematical identity:

$$\langle \partial_\alpha A(\mathcal{I}|\theta) \rangle - \partial_\alpha \langle A(\mathcal{I}|\theta) \rangle = \langle A(\mathcal{I}|\theta)v_\alpha(\mathcal{I}|\theta) \rangle, \quad (74)$$

which is obtained from Eq.(73) taking the partial derivative $\partial_\alpha = \partial/\partial\theta^\alpha$. The first two identities can be regarded as the stationary and stability conditions of maximal likelihood estimators of Eq.(70) written in term of statistical expectation values. Using the

Inference theory	Fluctuation theory
score vector components: $v_\alpha(\mathcal{I} \theta) = -\frac{\partial}{\partial\theta^\alpha} \log \rho(\mathcal{I} \theta)$	generalized differential forces: $\eta_i(I \theta) = -\frac{\partial}{\partial I^i} \log \rho(I \theta)$
conditions for likelihood estimators : $v_\alpha(\mathcal{I} \hat{\theta}_{ml}) = 0, \frac{\partial}{\partial\theta^\alpha} v_\beta(\mathcal{I} \hat{\theta}_{ml}) \succ 0$	thermodynamic equilibrium conditions: $\eta_i(\bar{I} \theta) = 0, \frac{\partial}{\partial I^i} \eta_j(\bar{I} \theta) \succ 0$
inference fluctuation theorems: $\langle v_\alpha(\mathcal{I} \theta) \rangle = 0$ $\langle \frac{\partial}{\partial\theta^\alpha} v_\beta(\mathcal{I} \theta) \rangle = \langle v_\alpha(\mathcal{I} \theta) v_\beta(\mathcal{I} \theta) \rangle$ $\langle v_\alpha(\mathcal{I} \theta) \delta\hat{\theta}^\beta \rangle = -\delta_\alpha^\beta$	equilibrium fluctuation theorems: $\langle \eta_i(I \theta) \rangle = 0$ $\langle \frac{\partial}{\partial I^i} \eta_j(I \theta) \rangle = \langle \eta_i(I \theta) \eta_j(I \theta) \rangle$ $\langle \eta_i(I \theta) \delta I^j(I \theta) \rangle = \delta_i^j$

Table 1. Fluctuation theory and inference theory can be regarded as dual counterpart statistical approaches.

Cauchy-Schwartz inequality, the third relation states a strong fluctuation relation between unbiased estimators and the score vector components:

$$\Delta v_\alpha \Delta \hat{\theta}^\alpha \geq 1, \quad (75)$$

which can be generalized by the following inequality:

$$\langle \delta\hat{\theta}^\alpha \delta\hat{\theta}^\beta \rangle - g_F^{\alpha\beta}(\theta) \succ 0. \quad (76)$$

Here, $g_F^{\alpha\beta}(\theta)$ denotes the inverse matrix of the Fisher's inference matrix (10):

$$g_F^{\alpha\beta}(\theta) = \langle v_\alpha(\mathcal{I}|\theta) v_\beta(\mathcal{I}|\theta) \rangle. \quad (77)$$

Eq.(76) is the famous *Cramer-Rao theorem* of inference theory (11), which puts a lower bound to the efficiency of any unbiased estimators $\hat{\theta}^\alpha$.

As clearly shown in Table 1, fluctuation theory and inference theory can be regarded as *dual counterpart statistical approaches* (9). In fact, there exists a direct correspondence among their respective definitions and theorems. As naturally expected, inequalities of Eqs.(67) and (75) could be employed to introduce *uncertainty relations* in a given physical theory with a statistical mathematical apparatus.

4. Complementarity in classical statistical mechanics

Previously, many specialists proposed different attempts to support the existence of an *energy-temperature complementarity* inspired on Bohr's arguments referred to in the introductory section. Relevant examples of these attempts were proposed by Rosenfeld (23), Mandelbrot (24), Gilmore (25), Lindhard (26), Lavenda (27), Schölg (28), among other authors. Remarkably, the versions of this relation which have appeared in the literature give different interpretations of the uncertainty in temperature $\Delta(1/T)$ and often employ widely different theoretical frameworks, ranging from statistical thermodynamics to modern theories of *statistical inference*. Despite of all devoted effort, this work has not led to a consensus in the literature, as clearly discussed in the most recent review by J. Uffink and J. van Lith (6).

An obvious objection is that the mathematical structure of quantum theories is radically different from that of classical physical theories. In fact, classical theories are not developed

using an *operational formulation*. Remarkably, the previous section evidences that any physical theory with a classical statistical apparatus could support the existence of quantities with a complementary character. Let us analyze the consequences of the uncertainty-like inequalities (67) and (75) in the question about the energy-temperature complementarity in the framework of classical statistical mechanics.

4.1 Energy-temperature complementarity in the framework of inference theory

Mandelbrot was the first to propose an inference interpretation of the Bohr's hypotheses about the *energy-temperature complementarity* (29). Starting from the *canonical ensemble* (CE):

$$dp_{CE}(E|\beta) = \exp(-\beta E/k_B) \Omega(E) dE / Z(\beta), \quad (78)$$

where $\beta = 1/T$, and applying the Cramer-Rao theorem (75), this author obtains the following uncertainty-like inequality:

$$\Delta \hat{\beta} \Delta E \geq k_B, \quad (79)$$

where $\Delta \hat{\beta}$ is just the uncertainty of the inverse temperature parameter β associated with its determination via an inferential procedure from a single measurement ($s = 1$), while ΔE is the statistical uncertainty of the energy. This type of inference interpretation of uncertainty relations can be extended in the framework of *Boltzmann-Gibbs distributions* (BG):

$$dp_{BG}(E, X|\beta, \xi) = \exp[-(\beta E + \xi X)/k_B] \Omega(E, X) dE / Z(\beta, \xi), \quad (80)$$

to the other pairs of conjugated thermodynamic variables:

$$\Delta \hat{\xi} \Delta X \geq k_B, \quad (81)$$

where $\xi = \beta Y$. Here, X represents a generalized displacement (volume V , magnetization M , etc.) while Y is its conjugated generalized force (pressure p , magnetic field H , etc.). Nowadays, this type of inference arguments have been also employed in modern interpretations of quantum uncertainty relations (30–32).

There exist many attempts in the literature to support the energy-temperature complementarity starting from conventional statistical ensembles as (78) or (80), which are reviewed by Uffink and van Lith in Ref.(6). As already commented by these authors, the inequality (79) cannot be taken as a proper uncertainty relation. In fact, it is impossible to reduce to zero the energy uncertainty $\Delta E \rightarrow 0$ to observe an indetermination of the inverse temperature $\Delta \hat{\beta} \rightarrow \infty$ because ΔE is *fixed* in the canonical ensemble (78). Consequently, the present inference arguments are useless to support the existence of a complementarity between *thermal contact* and *energetic isolation*, as it was originally suggested by Bohr. In our opinion, all these attempts are condemned to fail due to a common misunderstanding of the *temperature concept*.

4.2 Remarks on the temperature notion

Many investigators, including Bohr (3), Landau (5) and Kittel (33), assumed that a *definite temperature can only be attribute to a system when it is put in thermal contact with a heat bath*. Although this is the temperature notion commonly employed in thermal physics, this viewpoint implies that the temperature of an isolated system is *imperfectly defined*. This opinion is explicitly expressed in the last paragraph of section §112 of the known Landau & Lifshitz treatise (5). By itself, this idea is *counterfactual*, since it could not be possible to attribute a definite temperature for the system acting as a *heat reservoir* when it is put into *energetic*

isolation. Conversely, the temperature notion of an isolated system admits an unambiguous definition in terms of the famous *Boltzmann's interpretation of thermodynamic entropy*:

$$S = k_B \log W \rightarrow \frac{1}{T} = \frac{\partial S}{\partial E}, \quad (82)$$

where W is the number of microstates compatible with a given macroscopic configuration, e.g.: $W = Sp[\delta(E - \mathcal{H})] \epsilon_0$, with ϵ_0 being a small energy constant that makes W a dimensionless quantity. One realizes after revising the Gibbs' derivation of canonical ensemble (78) from the microcanonical basis that the temperature T appearing as a parameter in the canonical distribution (78) is just the *microcanonical temperature* (82) of the heat reservoir when its size N is sent to the thermodynamic limit $N \rightarrow \infty$. Although such a parameter characterizes the internal conditions of the heat reservoir and its thermodynamic influence on the system under consideration, the same one cannot provide a correct definition for the internal temperature of the system. While the difference between the temperature appearing in the canonical ensemble (78) and the one associated with the microcanonical ensemble (82) is irrelevant in most of everyday practical situations involving *extensive systems*, this is not the case of *small systems*. In fact, microcanonical temperature (82) appears as the only way to explain the existence of *negative heat capacities* $C < 0$:

$$\frac{\partial}{\partial E} \left(\frac{1}{T} \right) = -\frac{1}{T^2 C} \Rightarrow C = - \left(\frac{\partial S}{\partial E} \right)^2 / \left(\frac{\partial^2 S}{\partial E^2} \right) \quad (83)$$

through the *convex character* of the entropy (34), $\partial^2 S / \partial E^2 > 0$. Analyzing the microcanonical notion of temperature (82), one can realize that *only a macroscopic system has a definite temperature into conditions of energetic isolation*. According to this second viewpoint, the system energy E and temperature T cannot manifest a complementary relationship. However, a careful analysis reveals that this preliminary conclusion is *false*.

According to definition (82), temperature is a concept with *classical* and *statistical* relevance. Temperature is a classical notion because of the entropy S should be a *continuous function* on the system energy E . In the framework of quantum systems, this requirement demands the validity of the *continuous approximation* for the system density of states $\Omega(E) = Sp[\delta(E - \hat{\mathcal{H}})]$. Those quantum systems unable to satisfy this last requirement cannot support an *intrinsic value of temperature* T . By itself, this is the main reason why the temperature of thermal physics is generally assumed in the framework of quantum theories. On the other hand, temperature manifests a statistical relevance because of its definition demands the notion of *statistical ensemble*: a set of identical copies of the system compatible with the given macroscopic states. Although it is possible to apply definition (82) to predict temperature $T(E)$ as a function on the system energy E , the practical determination of energy-temperature relation is restricted by the statistical relevance of temperature. In the framework of thermodynamics, the determination of temperature T and the energy E , as well as other conjugated thermodynamic quantities, is based on the interaction of this system with a *measuring instruments*, e.g.: a thermometer, a barometer, etc. Such experimental measurements always involve an uncontrollable perturbation of the initial internal state of the system, which means that thermodynamic quantities as energy E and temperature T are only determined in an imperfect way.

4.3 Energy-temperature complementarity in the framework of fluctuation theory

To arrive at a proper uncertainty relation among thermodynamic variables, it is necessary to start from a general equilibrium situation where the external influence acting on the system under analysis can be controlled, *at will*, by the observer. In classical fluctuation theory, as example, the specific form of the distribution function $dp(I|\theta)$ is taken from the Einstein's postulate (5):

$$dp(I|\theta) = A \exp [S(I|\theta)/k_B] dI, \quad (84)$$

which describes the fluctuating behavior of a closed system with total entropy $S(I|\theta)$. Let us admit that the system under analysis and the measuring instrument conform a closed system. The separability of these two systems admits the additivity of the total entropy $S(I|\theta) = S(I) + S^m(I|\theta)$, where $S^m(I|\theta)$ and $S(I)$ are the contributions of the measuring instrument and the system, respectively.

For convenience, it is worth introducing the *generalized differential operators* $\hat{\eta}_i$

$$\hat{\eta}_i = -k_B \frac{\partial}{\partial I^i} \rightarrow \hat{\eta}_i \rho(I|\theta) = \eta_i(I|\theta) \rho(I|\theta), \quad (85)$$

which act over the probability density $\rho(I|\theta)$ associated with the statistical ensemble (84), providing in this way the difference $\eta_i(I|\theta)$ of the generalized forces $\zeta = (\beta, \xi)$:

$$\eta_i(I|\theta) = \zeta_i^m - \zeta_i \quad (86)$$

between the system and the measuring instrument:

$$\zeta_i = \frac{\partial S(I)}{\partial I^i} \text{ and } \zeta_i^m = -\frac{\partial S^m(I|\theta)}{\partial I^i}. \quad (87)$$

Clearly, the vanishing of the expectation values $\langle \eta_i(I|\theta) \rangle$ drop to the known *thermodynamic equilibrium conditions*:

$$\langle \zeta_i^m \rangle = \langle \zeta_i \rangle, \quad (88)$$

which are written in the form of *statistical expectation values*. In particular, the *condition of thermal equilibrium* is expressed as follows:

$$\left\langle \frac{1}{T} \right\rangle = \left\langle \frac{1}{T^m} \right\rangle, \quad (89)$$

where T and T^m are the temperatures of the system and the measuring instrument (thermometer), respectively. Analogously, the *condition of mechanical equilibrium*:

$$\left\langle \frac{p}{T} \right\rangle = \left\langle \frac{p^m}{T^m} \right\rangle, \quad (90)$$

where p and p^m are the internal pressures of the system and its measuring instrument (barometer). The application of inequality (67) leads to a special interpretation of the notion of *complementarity between conjugated thermodynamic quantities*:

$$\Delta(\zeta_i^m - \zeta_i) \Delta I^i \geq k_B. \quad (91)$$

Particular examples of these inequalities are the *energy-temperature uncertainty relation* (8):

$$\Delta(1/T - 1/T^m) \Delta E \geq k_B, \quad (92)$$

and the *volume-pressure uncertainty relation*:

$$\Delta(p/T - p^m/T^m)\Delta V \geq k_B. \quad (93)$$

These inequalities express *the impossibility to perform an exact experimental determination of conjugated thermodynamic variables* (e.g.: energy E and temperature T or volume V and pressure p , etc.) *using any experimental procedure based on the thermodynamic equilibrium with a measuring instrument*. Conversely to inference *uncertainty relations* (79) and (81), the system statistical uncertainties ΔE and ΔV can now be modified *at will* changing the experimental setup, that is, modifying the properties of the measuring instrument.

4.4 Analogies between quantum mechanics and classical statistical mechanics

A simple comparison between classical statistical mechanics and quantum mechanics involves several analogies between these statistical theories (see in Table 2). Physical theories as classical mechanics and thermodynamics assume a simultaneous definition of complementary variables like the coordinate and the momentum (\mathbf{q}, \mathbf{p}) or the energy and the inverse temperature $(E, 1/T)$. A different situation is found in those applications where the relevant constants as the quantum of action \hbar or the Boltzmann's constant k_B are not so small. According to uncertainty relations shown in equations (3) and (92), the thermodynamic state $(E, 1/T)$ of a small thermodynamic system is badly defined in an analogous way that a quantum system cannot support the classical notion of particle trajectory $[\mathbf{q}(t), \mathbf{p}(t)]$.

Apparently, uncertainty relations can be associated with the *coexistence of variables with different relevance* in a statistical theory. In one hand, we have the variables parameterizing the *results of experimental measurements*: space-time coordinates (t, \mathbf{q}) or the mechanical macroscopic observables $I = (I^i)$. On the other hand, we have their conjugated variables associated with the *dynamical description*: the energy-momentum (E, \mathbf{p}) or the generalized differential forces $\eta = (\eta_i)$. These variables control the respective deterministic dynamics: while the energy E and the momentum \mathbf{p} constrain the trajectory $\mathbf{q}(t)$ of a classical mechanic system, the inverse temperature differences, $\eta = 1/T^m - 1/T$, drives the dynamics of the system energy $E(t)$ (i.e.: the energy interchange) and its tendency towards the equilibrium. Similarly, the experimental determination of these dynamical variables demands the consideration of many repeated measurements due to their explicit statistical significance in the framework of their respective statistical theories.

According to the comparison presented in Table 2, the classical action $S(\mathbf{q}, t)$ and the thermodynamic entropy $S(I|\theta)$ can be regarded as two counterpart statistical functions. Interestingly, while the expression (10) describing the relation between the wave function $\Psi(\mathbf{q}, t)$ and the classical action $S(\mathbf{q}, t)$ is simply an asymptotic expression applicable in the quasi-classic limit where $S(\mathbf{q}, t) \gg \hbar$, Einstein's postulate (84) is conventionally assumed as an *exact expression* in classical fluctuation theory. The underlying analogy suggests that Einstein's postulate (84) should be interpreted as an asymptotic expression obtained in the limit $S(I|\theta) \gg k_B$ of a *more general statistical mechanics theory*. This requirement is always satisfied in conventional applications of classical fluctuation theory, which deal with the small fluctuating behavior of large thermodynamic systems. Accordingly, this important hypothesis of classical fluctuation theory should lost its applicability in the case of small thermodynamic systems. In the framework of such a general statistical theory, Planck's constant k_B could be regarded as the *quantum of entropy*.

Classical mechanics provides a precise description for the systems with large quantum numbers, or equivalently, in the limit $\hbar \rightarrow 0$. Similarly, thermodynamics appears as a suitable

Comparison criterium	Quantum mechanics	Classical statistical mechanics
parametrization	space-time coordinates (t, \mathbf{q})	mechanical macroscopic observables $I = (I^i)$
probabilistic description	wave function $\psi(\mathbf{q}, t)$	distribution function $dp(I \theta) = \rho(I \theta) dI$
relevant physical hypothesis	<i>Correspondence principle:</i> $\psi(\mathbf{q}, t) \sim \exp[iS(\mathbf{q}, t)/\hbar]$, where $S(\mathbf{q}, t)$ is the action	Einstein's postulate: $\rho(I \theta) \sim \exp[S(I \theta)/k_B]$, where $S(I \theta)$ is the entropy
evolution	dynamical conservation laws	tendency towards thermodynamic equilibrium
conjugated variables	energy $E = \partial S(\mathbf{q}, t) / \partial t$ momenta $\mathbf{p} = \partial S(\mathbf{q}, t) / \partial \mathbf{q}$	differential forces $\eta_i = \partial S(I \theta) / \partial I^i$
complementary quantities	(\mathbf{q}, t) versus (\mathbf{p}, E)	I^i versus η_i
operator representation	$\hat{q}^i = q^i$ and $\hat{p}_i = -i\hbar \frac{\partial}{\partial q^i}$	$\hat{I}^i = I^i$ and $\hat{\eta}_i = -k_B \frac{\partial}{\partial I^i}$
commutation and uncertainty relations	$[\hat{q}^j, \hat{p}_i] = i\hbar \delta_i^j$ $\Delta q^i \Delta p_i \geq \hbar/2$	$[\hat{I}^j, \hat{\eta}_i] = \delta_i^j k_B$ $\Delta I^i \Delta \eta_i \geq k_B$
deterministic theory	classical mechanics	thermodynamics

Table 2. Comparison between quantum mechanics and classical statistical mechanics. Despite their different mathematical structures and physical relevance, these theories exhibit several analogies as consequence of their statistical nature.

treatment for systems with a large number N of degrees of freedom, or equivalently the limit $k_B \rightarrow 0$. It is always claimed that quantum mechanics occupies an unusual place among physical theories: classical mechanics is contained as a limiting case, yet at the same time it requires this limit for its own formulation. However, it is easy to realize that this is not a unique feature of quantum mechanics. In fact, classical statistical mechanics also contains thermodynamics as a limiting case. Moreover, classical statistical mechanics requires thermodynamic notions for its own formulation, which is particularly evident in classical fluctuation theory. The interpretation of the generalized differential forces, $\eta(I|\theta) = -k_B \partial_I \log \rho(I|\theta)$, as the difference between the generalized forces ζ_i and ζ_i^m of the measuring instrument and the system shown in equation (86) is precisely based on the correspondence of classical statistical mechanics with thermodynamics through Einstein's postulate (84).

Analogously, both statistical theories demand the presence of a second system with a well-defined *deterministic description*. Any measuring instrument to study quantum mechanics is just a system that obeys classical mechanics with a sufficient accuracy, e.g.: a photographic plate. Analogously, a measuring instrument in classical statistical mechanics is a system that exhibits an accurate thermodynamical description, e.g.: a thermometer should exhibit a well-defined temperature dependence of its *thermometric variable*. If the systems under study are sufficiently small, any direct measurement involves an uncontrollable perturbation of their initial state. In particular, any experimental setup aimed to determine temperature T must involve an energy interchange via a thermal contact, which affects the internal energy E .

Conversely, it is necessary *energetic isolation* to preserve the internal energy E , thus excluding a direct determination of its temperature T .

While the classical statistical mechanics is probability theory that deals with quantities with a real character, the quantum mechanics is formulated in terms of *complex probability amplitudes* that obey the superposition principle. Despite this obvious difference, both statistical theories admit the correspondence of the physical observables with certain *operators*. Determination of the energy E and the momentum \mathbf{p} demands repeated measurements in a finite region of the space-time sufficient for observing the wave properties of the function $\Psi(\mathbf{q}, t)$. The system temperature determination also demands the exploration of a finite energy region sufficient for determining the probability density $\rho(I|\theta)$. Mathematically, these experimental procedures can be associated with differential operators: the quantum operators $\hat{E} = i\hbar\partial_t$, $\hat{\mathbf{p}} = -i\hbar\nabla$ and the statistical mechanics operator $\hat{\eta} = -k_B\partial_I$. It is easy to realize that the complementary character between the macroscopic observables I^i and the generalized differential forces η_i can be related to the fact that their respective operators $\hat{I}^i = I^i$ and $\hat{\eta}_i = -k_B\partial_{I^i}$ do not commute $[\hat{I}^i, \hat{\eta}_i] = k_B$:

$$\int_{\mathcal{M}_\theta} [\hat{I}^i, \hat{\eta}_i] \rho(I|\theta) dI \equiv \int_{\mathcal{M}_\theta} \hat{I}^i \hat{\eta}_i \rho(I|\theta) dI = k_B \Rightarrow \langle \delta I^i \delta \eta_i \rangle = k_B \Rightarrow \Delta I^i \Delta \eta_i \geq k_B. \quad (94)$$

There exist other differences between these statistical theories. For example, variables and functions describing the measuring instruments explicitly appear in probability description of classical statistical mechanics; e.g.: the entropy contribution of the measuring instrument $S^m(I|\theta)$ and the generalized forces ζ_i^m . Conversely, the measuring instruments do not appear in this explicit way in the formalism of quantum mechanics. The nature of the measuring instruments are specified in the concrete representation of the wave function Ψ . For example, the quantity $|\Psi(\mathbf{q}, t)|^2$ written in the coordinate-representation measures the probability density to detect a microparticle at the position \mathbf{q} using an appropriate measuring instrument to obtain this quantity. Analogously, the quantity $|\Psi(\mathbf{p}, t)|^2$ expressed in the momentum-representation describes the probability density to detect a particle with momentum \mathbf{p} using an appropriate *instrument* that measures a *recoil effect*.

5. Final remarks

Classical statistical mechanics and quantum theory are two formulations with different mathematical structure and physical relevance. However, these physical theories are hallmarked by the existence of *uncertainty relations between conjugated quantities*. Relevant examples are the coordinate-momentum uncertainty $\Delta q \Delta p \geq \hbar/2$ and the energy-temperature uncertainty $\Delta E \Delta(1/T - 1/T^m) \geq k_B$. According to the arguments discussed along this chapter, *complementarity* has appeared as an unavoidable consequence of the statistical apparatus of a given physical theory. Remarkably, classical statistical mechanics and quantum mechanics shared many analogies with regards to their conceptual features: (1) Both statistical theories need the correspondence with a *deterministic theory* for their own formulation, namely, classical mechanics and thermodynamics; (2) The measuring instruments play a role in the existence of complementary quantities; (3) Finally, physical observables admit the correspondence with appropriate operators, where the existence of complementary quantities can be related to their noncommutative character.

As an open problem, it is worth remarking that the present comparison between classical statistical mechanics and quantum mechanics is still incomplete. Although the analysis

of complementarity has been focused in those systems in thermodynamic equilibrium, the operational interpretation discussed in this chapter strongly suggests the existence of a counterpart of Schrödinger equation (42) in classical statistical mechanics. In principle, this counterpart dynamics should describe the system evolutions towards the thermodynamic equilibrium, a statistical theory where Einstein's postulate (84) appears as a *correspondence principle* in the thermodynamic limit $k_B \rightarrow 0$.

6. References

- [1] N. Bohr, *Causality and Complementarity in The Philosophical Writings of Niels Bohr*, Volume IV, Jan Faye and Henry J. Folse (eds) (Ox Bow Press, 1998).
- [2] W. Heisenberg, (1927) *Z. Phys.* 43 172.
- [3] N. Bohr in: *Collected Works*, J. Kalckar, Ed. (North-Holland, Amsterdam, 1985), Vol. 6, pp. 316-330, 376-377.
- [4] W. Heisenberg, *Der Teil und das Gauze*, Ch. 9. R. piper, Miinchen (1969).
- [5] L. D. Landau and E. M. Lifshitz, *Statistical Physics* (Pergamon Press, London, 1980).
- [6] J. Uffink and J. van Lith, *Found. Phys.* 29 (1999) 655.
- [7] L. Velazquez and S Curilef, *J. Phys. A: Math. Theor.* 42 (2009) 095006.
- [8] L. Velazquez and S. Curilef, *Mod. Phys. Lett. B* 23 (2009) 3551.
- [9] L. Velazquez and S. Curilef, *J. Stat. Mech.: Theo. Exp.* (2010) P12031.
- [10] R. A. Fisher, *On the mathematical foundations of theoretical statistics*, Philosophical Transactions, Royal Society of London, (A), Vol. 222, pp. 309-368.
- [11] C. R. Rao, *Bull. Calcutta Math. Soc.* 37, 81-91.
- [12] A. S. Davydov, *Quantum mechanics* (Elsevier, 1965).
- [13] C. Jönsson, *Z. Phys.* 161 (1961) 454; *Am. J. Phys.* 4 (1974) 4.
- [14] L. de Broglie *Researches on the quantum theory*, Ph.D. Thesis, (Paris, 1924).
- [15] M. Born, *The statistical interpretation of quantum mechanics*, Nobel Lecture, 1954.
- [16] N. Bohr (1920) *Z. Phys.* 2 (5) 423-478.
- [17] N. Bohr (1913) *Philosophical Magazine* 26 1-24; 26 476-502; 26 857-875.
- [18] G. Esposito, G. Marmo and G. Sudarshan, *From classical to quantum mechanics* (Cambridge University Press, 2004).
- [19] L. D. Landau and E. M. Lifshitz, *Course of Theoretical Physics: Quantum Mechanics non relativistic theory* Vol. 3 (Pergamon, 1991).
- [20] H.P. Robertson, *Phys. Rev.* 34 (1929) 573-574.
- [21] E.H. Kennard, *Z. Phys.* 44 (1927) 326-352.
- [22] E. Schrödinger, *Berliner Berichte* (1930) 296-303.
- [23] L. Rosenfeld, in *Ergodic Theories*, P. Caldirola (ed) (Academic Press, 1961), pp. 1.
- [24] B. B. Mandelbrot, *Ann. Math. Stat.* 33 (1962) 1021; *J. Math. Phys.* 5 (1964) 164.
- [25] R. Gilmore, *Phys. Rev. A* 31 (1985) 3237.
- [26] J. Lindhard, *The Lessons of Quantum Theory*, J. de Boer, E. Dal and O.Ulfbeck (eds) (Elsevier, Amsterdam, 1986).
- [27] B. Lavenda, *Int. J. Theor. Phys.* 26 (1987) 1069; *Statistical Physics: A Probabilistic Approach* (Wiley, New York, 1991).
- [28] F. Schölg, *J. Phys. Chem. Sol.* 49 (1988) 679.
- [29] B. B. Mandelbrot, *Ann. Math. Stat.* 33 (1962) 1021; *Phys. Today* 42 (1989) 71.
- [30] A. S. Holevo, *Probabilistic and Statistical Aspects of Quantum Theory* (North-Holland, Amsterdam, 1982).

- [31] E. R. Caianiello, in *Frontiers of Non-Equilibrium Statistical Physics*, G. T. Moore and M. O. Scully (eds) (Plenum, New York, 1986), pp. 453-464.
- [32] S. L. Braunstein, in *Symposium on the Foundations of Modern Physics 1993*, P. Busch, P. Lahti, and P. Mittelstaedt (eds) (World Scientific, Singapore, 1993) pp. 106.
- [33] Ch. Kittel, *Phys. Today* 41 (1988) 93.
- [34] W. Thirring, *Z. Phys.* 235 (1970) 339; *Quantum Mechanics of large systems* (Springer, 1980) Chap. 2.3.

The Physical Nature of Wave/Particle Duality

Marcello Cini
Università La Sapienza, Roma
Italy

1. Introduction

1.1 Waves and particles in quantum mechanics

In spite of the fact that the extraordinary progress of experimental techniques make us able to manipulate at will systems made of any small and well defined number of atoms, electrons and photons - making therefore possible the actual performance of the *gedankenexperimente* that Einstein and Bohr had imagined to support their opposite views on the physical properties of the wavelike/particlelike objects (*quanta*) of the quantum world - it does not seem that, after more than eighty years, a unanimous consensus has been reached in the physicist's community on how to understand their "strange" properties.

Unfortunately, we cannot know whether Feynman would still insist in maintaining his famous sentence "It is fair to say that nobody understands quantum mechanics". We can only discuss if, almost thirty years after his death, some progress towards this goal has been made. I believe that this is the case. I will show in fact that, by following the suggestions of Feynman himself, some clarification of the old puzzles can be achieved. This chapter therefore by no means is intended to provide an impartial review of the present status of the question but is focused on the exposure of the results of more than twenty years of research of my group in Rome, which in my opinion provide a possible way of connecting together at the same time the random nature of the events at the atomic level of reality and the completeness of their probabilistic representation by the principles of Quantum Mechanics.

1.2 The two slits experiment

In order to introduce the reader to the issues at stake I will briefly recall the essence of the debate between Bohr and Einstein which took place after the Fifth Solvay Conference (1927) where for the first time the different independent formulations of the new theory were presented by Heisenberg, Dirac, Born and Schrödinger, together with their common interpretation by Bohr - the so-called "Copenhagen interpretation" of Quantum Mechanics - which won since then a practically unanimous acceptance by the community.

This acceptance remained unquestioned for thirty years until when the books by Max Jammer (Jammer a1966, b1974) presented again to the new generation of physicists the ambiguities which still remained unsolved, and stimulated a renewed interest on those conceptual foundations of the theory which had been set aside under the impact of the extraordinary experimental and theoretical boom of physics triggered at the end of World War 2 by the opening of the Nuclear Era.

The central issue of the debate, according to Jammer's reconstruction (Jammer 1974 p.127), was "whether the existing quantum mechanical description of microphysical phenomena should and could be carried further to provide a more detailed account, as Einstein suggested, or whether it already exhausted all possibilities of accounting for observable phenomena, as Bohr maintained. To decide on this issue, Bohr and Einstein agreed on the necessity of reexamining more closely those thought-experiments by which Heisenberg vindicated the indeterminacy relations and by which Bohr illustrated the mutual exclusion of simultaneous space-time and causal descriptions."

The thought experiment which both agreed to discuss was the diffraction of a beam of particles of momentum p impinging perpendicularly on a screen D with two slits S_1 and S_2 at a distance d from each other. Each particle, which passes through, falls, deviating at random from its initial direction, on a photographic plate P located after the screen. When a sufficiently high number of particles has been detected, a distribution of diffraction fringes typical of a wave with a central maximum and adjacent minima and less pronounced maxima appears. Each particle is detected locally, but seems to propagate as a wave.

Its wavelike nature is expressed by the Bragg's relation connecting the wavelength λ of the wave in terms of the distance d between the slits and the angle φ subtended by the central diffraction maximum ($\lambda = \varphi d$). On the other side its particlelike nature is expressed by its momentum p which is connected to the wavelength by the de Broglie's relation ($p = h/\lambda$).

Since it is not possible to detect through which slit the particle is passed, its position x on D is uncertain by $\Delta x = d$. For the same reason, the momentum acquired by the particle in deviating from its initial direction normal to D is uncertain by $\Delta p = \varphi p$

From these relations the Heisenberg uncertainty relation

$$\Delta x = h/\Delta p$$

follows. Incidentally, the same phenomenon occurs with only one slit, with d now indicating the slit's width.

For Bohr eq. (1) holds for each individual particle. The particle's position x and its momentum p are, in his words, "complementary" variables. They cannot have simultaneously well defined sharp values. In the interaction with the classical instrument made of the screen D and the photographic plate P, each particle of the beam acquires a blunt value x affected by an uncertainty Δx and a blunt value p affected by an uncertainty Δp . The product of the uncertainties however, can never be less than the limit set by (1). Initially, before impinging on the instrument, each particle was in a state with a well defined sharp value of the momentum and a totally non localized position in space. At the end, after having been trapped in the photographic plate, each particle has acquired a well defined sharp value of its position in space, and has lost a well defined value of the momentum. The essence of the argument is that only by interacting with a suitable classical object one side of the quantum world acquires a real existence, at the expense of the complementary side becoming unseizable.

For Einstein instead Quantum Mechanics is only a statistical theory which does not fully describe reality *as it is*. The uncertainties, according to him, reflect only our uncomplete knowledge. He postulates the existence of "hidden variables" of still unknown nature, and concentrates his efforts on proving that Quantum Mechanics is "incomplete". In fact - he argues - if D is not fixed but is left free to move, one could identify the slit through which

the particle has passed by measuring the recoil of the screen produced by the momentum exchange with the particle deviated from its straight path. Both the position and the momentum of the particle could in this way be measured, violating the Heisenberg limit.

This does not work, however - replicates Bohr (Bohr 1948) - because the detection of "which slit" changes the diffraction pattern. In fact, he argues, if, by detecting the recoil of the screen one determines through which slit the particle has passed, the position in space of D becomes delocalized by a quantity ε in such a way that the resulting maxima and minima of the possible two-slit diffraction patterns superimpose and cancel each other. The original diffraction pattern with D fixed becomes the diffraction pattern of the single slit through which the particle is passed. Δx is reduced to the width of the slit and the uncertainty Δp is correspondingly increased. Heisenberg's relation for the particle still holds.

"It is not relevant - Bohr wrote many years later (Bohr 1958a) in a report of his debate with Einstein - that experiments involving an accurate control of the momentum or energy transfer from atomic particles to heavy bodies like diaphragms and shutters would be very difficult to perform, if practicable at all. It is only decisive that, in contrast to the proper measuring instruments, these bodies, together with the particles, would, in such a case constitute the system to which the quantum mechanical formalism has to be applied."

On the other hand, Bohr insists to stress the classical nature of the instrument (Bohr 1958b): "The entire formalism is to be considered as a tool for deriving predictions of definite statistical character, as regards information obtainable under experimental conditions described in classical terms.[...] The argument is simply that by the word "experiment" we refer to a situation where we can tell others what we have learned, and that, therefore, the account of the experimental arrangement and the results of the observations must be expressed in unambiguous language with suitable application of the terminology of classical physics."

It is therefore clear that for Bohr the *proper measuring instruments* on the one side must be treated as classical objects, but on the other one that the parts of the apparatus used for the determination of the localization in space time of particles and the energy-momentum transfer between particle and apparatus must be submitted to the quantum limitations. We will come back in a moment to this question in order to prove that this ambiguity can be understood in the framework of an interpretation of Quantum Mechanics in which both Einstein's purpose of saving the objectivity of the properties of macroscopic objects and Bohr's denial of the possibility of attributing to the objects at the atomic level independent properties, are recognized.

1.3 The EPR paradox

The second phase of the debate sees a change in Einstein's strategy of proving that the description of reality given by Quantum Mechanics is incomplete. This phase is based on the formulation of the EPR (Einstein, Podolski, Rosen) paradox (Einstein et al 1935).. I will briefly sketch its main argument, even if it is not essential for the further development of the argument of this Chapter.

This is how the authors formulate the basic assumption of their argument: "If, without in any way disturbing a system, we can predict with certainty the value of a physical quantity, then there exists an element of physical reality corresponding to this physical quantity."

Consider a system of two particles in a state in which the relative distance $x_1 - x_2 = a$ and their total momentum $p_1 + p_2 = p$ are fixed. This is possible because these quantities are not

complementary. Then EPR argue as follows. By measuring the position x_1 of the first particle it is possible, *without interfering directly with the second particle*, determine its position $x_2 = a + x_1$. This means that, according the initial definition, that x_2 is an *element of reality*. However, we might have chosen to measure, instead of x_1 the momentum p_1 of the first particle. This measurement would have allowed us to assess, without interfering in any way with the second particle, that its momentum $p_2 = p - p_1$ is an element of reality. This would have allowed to conclude that p_2 is an element of reality. Therefore, Einstein sums up, Quantum Mechanics is incomplete.

Bohr's answer stresses once more that one cannot speak of quantities existing independently of the actual procedure of measuring them: "From our point of view we now see that the wording of the above mentioned criterion of physical reality proposed by EPR contains an ambiguity as regards the meaning of the expression "without in any way disturbing a system". Of course there is, in a case like that just considered, no question of a mechanical disturbance of the system under investigation during the last critical stage of the measuring procedure. But even at this stage there is essentially the question of an influence on the very conditions which define the possible types of predictions regarding the future behaviour of the system. Since these conditions constitute an inherent element of the description of any phenomenon to which the term "physical reality" can be properly attached, we see that the argumentation of the mentioned authors does not justify their conclusion that quantum-mechanical description is essentially incomplete."

Einstein recognized that Bohr might be right, but remained attached to his own point of view (Bohr 1958b): ""To believe [that it should offer an exhaustive description of the individual phenomena] is logically possible without contradiction; - he admits - but it is so very contrary to my scientific instinct that I cannot forego the search for a more complete conception."

The question remained open for almost 50 years but was solved by two fundamental contributions. In 1964 John Bell (Bell 1964) showed that Einstein's hypothesis of the existence of hidden variables capable of describing reality in more detail than QM might lead to an experimental test. In order to sketch Bell's argument a reformulation of the original EPR proposal is necessary. Instead of choosing the relative distance and the total momentum as variables of the two-particle system with assigned initial value one assumes that they are two spin $\frac{1}{2}$ particles in a state (singlet) of total angular momentum zero. In this state the components along three orthogonal directions are all zero, in spite of the fact that the three components of angular momentum are incompatible variable between themselves. Bell's idea is the following. Rather than discussing the legitimacy of speaking of a physical variable without having measured it, he proposes of measuring the component of the spin of particle #1 in a direction \mathbf{a} and the component of the spin of particle #2 in another direction \mathbf{b} . After a series of measurements on a great number N of pairs the results are correlated by a function $C(\mathbf{a}, \mathbf{b}) = \sum a_i b_i$ (a_i and b_i may have values ± 1) which depends on the angle θ between \mathbf{a} and \mathbf{b} . The point is, Bell shows, that Einstein's hypothesis of hidden variables leads to an inequality

$$\begin{aligned} |C(\mathbf{a}, \mathbf{b}) - C(\mathbf{a}, \mathbf{b}')| &= (1/N) |\sum a_i (b_i - b'_i)| \leq (1/N) |\sum (b_i - b'_i)| = \\ &= (1/N) |\sum (1 - b_i - b'_i)| = 1 + C(\mathbf{b}, \mathbf{b}') \end{aligned} \quad (1)$$

which is violated by the function $C(\mathbf{a}, \mathbf{b}) = -\cos\theta$ of QM.

Bell's inequality shows that the difference between Einstein's and Bohr's views is not only a matter of interpretation, but that the formalism of QM contradicts the hypothesis that incompatible variables may have at the same time sharp, even if unknown, values. The debate between Bohr and Einstein has been settled in favour of Bohr by Alain Aspect and coworkers (Aspect 1982) who showed in a celebrated experiment that the inequality (3) is violated for $(\mathbf{ab}) = 22,5^\circ$ et $(\mathbf{ab}') = 67,5^\circ$ by 5 standard déviations. Numerous other experiments have since then confirmed this result.

2. From quantons to objects

2.1 The existence of a classical world

We come back now to the ambiguous nature attributed by Bohr to the measuring apparatus. Does it belong to the classical or to the quantum world? In order to answer to this question we must preliminarily discuss the issue of the classical limit of Quantum Mechanics. We know that in the standard formulation of QM a system's state is represented by a wave function in the coherdinate's space (or a state vector in Hilbert space) which contains all the statistical properties of the system's variables. The wave function allows to calculate the probability of finding a given value of any variable of the system as a result of a measurement by means of a suitable instrument. More precisely, if the wave function is given by

$$\Psi = c_1 \psi_1 + c_2 \psi_2 \quad (2)$$

(where ψ_1 (ψ_2) represents a state in which the variable G has with certainty the value g_1 (g_2)), the probability of finding g_1 (g_2) is $|c_1|^2$ ($|c_2|^2$). In Bohr's interpretation this means that the variable G does not have one of these values before its measurement but assumes one or the other value with the corresponding probability during the act of measurement. Now comes the question: is this interpretation always valid, even when g_1 and g_2 are macroscopically different?

The answer poses a serious problem. One can in effect prove that in the limit when Planck's constant h tends to zero the probability distribution of the quantum state represented by ψ tends to the probability distribution in phase space of the corresponding classical statistical ensemble labeled by the same values of the system's quantum variables. More precisely, in this limit $|c_1|^2$ and $|c_2|^2$ represent the probabilities of finding the values g_1 (g_2) of the classical variable corresponding to the quantum variable G. In this case, however, the interpretation of these probabilities is completely different. In classical statistical mechanics we assume that they express an incomplete knowlwdge of the values of G actually possessed by the different systems of the ensemble. We assume in fact that, if the ensemble is made of N systems, there are N $|c_1|^2$ systems wuth the value g_1 of G and N $|c_2|^2$ systems with the value g_2 of G to start with. Each system has a given value of G from the beginning, even if we don't know it.

We arrive therefore to a contradiction. The same mathematical expression represents on the one side (classical limit of QM) the probability that a given system of the ensemble acquires a given value of the variable G as a consequence of its interaction with a suitable measuring instrument, and on the other side (classical statistical mechanics) the probability that the system considered had that value of G before its measurement. Suppose, for exemple that y represents a quantum in a box with two communicating cpmpartments: Ψ_1 is different from zero in the left side compartment and Ψ_2 is different from zero in the right side one. The

corresponding probabilities of finding the quanton in one or the other one are respectively $|c_1|^2$ and $|c_2|^2$. Suppose now that the two compartments are separated by a shutter and displaced far away from each other. One of them is then opened: It may contain the quanton or may be empty. At this point it is undoubtedly troubling to admit that, if one sticks strictly to Bohr's interpretation, the system in question instantly materializes in one or the other locality when the compartment is opened. Even more troubling is the fact that, if QM is the only true and universally valid theory of matter, the same conclusion must hold in principle also for macroscopic bodies.

2.2 Quantum and classical uncertainties

A way out of this dilemma, however, exists. We have shown, with Maurizio Serva (Cini M. Serva M. 1990, 1992), that, without changing the basic principles and the predictions of Quantum Mechanics, one can save at the same time both Bohr's interpretation of the phenomena of the quantum domain, and Einstein's belief in the objective reality of the classical world in which we live. We have shown in fact that the uncertainty product between x and p can be written for any state of a quanton in the form

$$(\Delta x \Delta p)^2 = (\Delta x \Delta p)_{cl}^2 + (\Delta x \Delta p)_q^2 \quad (3)$$

where $(\Delta x \Delta p)_q$ is of the order of the minimum value $h/4\pi$ of the Heisenberg uncertainty relation and $(\Delta x \Delta p)_{cl}$ is the classical expression of the product of the indeterminations Δx and Δp predicted by the probability distribution of the classical statistical mechanics distribution corresponding to the quantum state when $h \rightarrow 0$. It is therefore reasonable to attribute to each of these two terms the meaning relevant to its physical domain.

In the typical quantum domain the classical term vanishes and the indeterminacy is ontological, namely the variables x and p *do not have* a definite value before the system's interaction with a measuring instrument. When the accuracy of the act of measurement reduces the indeterminacy of one variable, the the indeterminacy of the other one increases. Their product cannot become smaller than $h/4\pi$.

As soon as the uncertainty product calculated from the state ψ acquires a classical term (which survives in the limit $h \rightarrow 0$) the total indeterminacy becomes epistemic, namely it represents an incomplete knowledge of the value that the measured variable really had before being measured. In this case it is possible to measure the variables x and p in such a way as to reduce at the same time both Δx et Δp without violating any quantum principle. These measurements reduce simply our ignorance. There is no instantaneous localization of the quanton in coordinate or momentum space as a consequence of the interaction between system and instrument, because position and momentum (within the intrinsic quantum uncertainty) were already localized.

This solution solves therefore the contradiction between the different interpretations of the total uncertainty product, and allows a reconciliation of the two alternative conceptions of physical reality proposed by Einstein and Bohr. It saves a realistic conception of the world as a whole by recognizing that macroscopic objects have objective properties independently of their being observed by any "observer", and, at the same time, that at the microscopic objects have properties dependent of the macroscopic objects with which they interact,

It allows also to clarify the ambiguity on the nature of the measurement apparatus mentioned above. One can in fact reformulate it in the following way. Assume that the microscopic

system S interacts with a part M_1 which at its turn interacts with a part M_2 and eventually other ones. We ask: at which point we pass the border between quantum domain and classical domain? The answer is not ambiguous. The border is where the values of the variable in one-to-one correspondence with the values of the quantum variable G, assume values which differ by each other by macroscopic quantities (e.g. charged or discharged counter). The part M_c when this happens is then the "pointer" of the instrument on whose unambiguous results all human observers agree.

This approach solves also a problem on which thousands of pages have been written, namely the problem of the "wave packet reduction" or "collapse" as a consequence of the act of measurement (Cini M, Levy Leblond J.M. 1991)(Wheeler J, Zurek W 1986). We recall that with this expression we mean that, after having measured G on a system S whose state is represented by ψ (eq.(1)) the wave function changes abruptly and instantaneously to ψ_1 or ψ_2 accordingly to the result g_1 or g_2 of the measurement. This change cannot be represented by a Schrödinger evolution, but must be postulated as a result of an instantaneous, irreversible and random evolution extraneous to QM. According to our findings (Cini M. et al 1979, Cini M. 1983) this additional and arbitrary mechanism is not necessary.

In fact, consider the simplest case S+M, in which M is a counter which has two macroscopically different states (charged or discharged) represented by two state vectors Φ_1 and Φ_2 . The wave function Ω of the total system may be written

$$\Omega = c_1 \psi_1 \Phi_1 + c_2 \psi_2 \Phi_2 \quad (4)$$

where we have assumed that the value g_1 (g_2) of the variable G of S is correlated with the charged (discharged) counter. The preceding discussion shows that, due to the macroscopic difference between Φ_1 and Φ_2 , the total system's state is, for all practical purposes, equivalent to a Gibbs classical ensemble made of $N |c_1|^2$ systems in which each counter is charged and S has the value g_1 of G and $N |c_2|^2$ systems in which each counter is discharged and S has the value g_2 of G. The wave packet reduction is therefore no longer needed as an additional postulate, and no additional mysterious agent (even less the "observer's consciousness") is required to explain it. It simply turns out to be a well known consequence of classical statistical mechanics.

2.3 EPR and conservation laws

A similar "realistic" approach can be adopted to discuss the third counterintuitive quantum phenomenon, the famous EPR "paradox", whose solution, after the numerous experiments confirming the violation of Bell's inequalities, can only be expressed by saying that Einstein was wrong in concluding that quantum mechanics is an incomplete theory.

Usually people ask: how is it possible that when the first particle of a pair initially having zero total angular momentum acquires in interaction with its filter a sharp value of a given component of its angular momentum, the far away particle comes to "know" that its own angular momentum component should acquire the same and opposite value? I do not think that a realistic interpretation of this counterintuitive behaviour can be "explained" by minimizing the difference with its classical counterpart, because this difference has its roots, in my opinion, in the "ontological" (or irreducible) - not "epistemical" (or due to imperfect knowledge) - nature of the randomness of quantum events. If this is the case, one has in fact to accept that physical laws do not formulate detailed prescriptions, enforced by concrete physical entities, about what *must* happen in the world, but only provide constraints and

express prohibitions about what *may* happen. Random events just happen, provided they comply to these constraints and do not violate these prohibitions.

From this point of view, the angular momentum component of the far away particle *has* to be equal and opposite to the measured value of the first particle's component, because otherwise the law of conservation of angular momentum would be violated. In fact, the quantity "total angular momentum" *is* itself, by definition, a non-local quantity. Non locality therefore needs not to be enforced by a mysterious *action-at-a-distance*. The two filters are not two uncorrelated pieces of matter: they are two rigidly connected parts of one single piece of matter which "measures" this quantity. The non local constraint is therefore provided by the nature of the macroscopic "instrument". This entails that, once the quantum randomness has produced the first partial sharp result, there is no freedom left for the result of the final stage of the interaction: there is no source of angular momentum available to produce any other result except the equal and opposite sharp value needed to add up to zero for the total momentum.

We arrive to the conclusion that Bohr was right, but Einstein was not wrong in insisting that an uncritical acceptance of the current interpretation of QM would lead to absurd statements about the physical nature of the world we live in.

3. The randomness of quantum reality in phase space

3.1 The representation of the irreducible randomness of quantum world in phase space

After eighty years of Quantum Mechanics (QM) we have learned to live with wave functions without worrying about their physical nature. This attitude is certainly justified by the extraordinary success of the theory in predicting and explaining not only all the phenomena encountered in the domain of microphysics, but also some spectacular nonclassical macroscopic behaviours of matter. Nevertheless one cannot ignore that the *wave-particle duality* of quantum objects not only still raises conceptual problems among the members of the small community of physicists who are still interested in the foundations of our basic theory of matter, but also induces thousands and thousands of physics students all around the world to ask each year, at their first impact with Quantum Mechanics, embarrassing questions to their teachers without receiving really convincing answers.

We have seen that typical examples of this dissatisfaction are the nonseparable character of long distance correlated two-particle systems and the dubious meaning of the superposition of state vectors of measuring instruments, and in general of all macroscopic objects (Schrödinger 1935). In the former case experiments have definitely established that Einstein was wrong in claiming that QM has to be completed by introducing extra "hidden" variables, but have shed no light on the nature of the *entangled* two-particle state vector responsible for the peculiar quantum correlation between them, a correlation which exceeds the classical one expected from the constraints of conservation laws.

In the latter case, generations of theoretical physicists in neoplatonist mood have insisted in claiming that the realistic aspect of macroscopic objects is only an illusion valid For All Practical Purposes (in jargon FAPP). The common core of their views is the belief that the only entity existing behind any object, be it small or large, is its wave function, which rules the random occurrence of the object's potential physical properties. The most extravagant and bold version of this approach is undoubtedly the one known as the Many Worlds Interpretation of QM Everett E.(1973), which goes a step further by eliminating the very

founding stone on which QM has been built, namely the essential randomness of quantum events. Chance disappears: the evolution of the whole Universe is written – a curious revival of Laplace - in the deterministic evolution of its wave function. “The Many-Worlds Interpretation (MWI) – in the words of Lev Vaidman, one of its most eminent supporters (Vaidman 2007) - is an approach to quantum mechanics according to which, in addition to the world we are aware of directly, there are many other similar worlds which exist in parallel at the same time and in the same space. The existence of the other worlds makes it possible to *remove randomness* and action at a distance from quantum theory and thus from all physics.”

I believe that it is grossly misleading to attribute the epistemological status of “consistent physical theory” to this sort of science fiction, which postulates the existence of myriads and myriads of *physical objects* (indeed entire worlds!) which are *in principle undetectable*. My purpose is to show that these difficulties can only be faced by pursuing a line of research which goes in the opposite direction, namely which takes for granted the irreducible nature of randomness in the quantum world. This can be done by eliminating *from the beginning* the unphysical concept of wave function. I believe that this elimination is conceptually similar to the elimination of the aether, together with its paradoxical properties, from classical electrodynamics, accomplished by relativity theory. In our case the lesson sounds: No wave functions, no problems about their physical nature.

Furthermore, the adoption of a statistical approach from the beginning for the description of the physical properties of quantum systems sounds methodologically better founded than the conventional *ad hoc* hybrid procedure of starting with the determination of a system’s wave function of unspecified nature followed by a “hand made” construction of the probability distributions of its physical variables. If randomness has an irreducible origin in the quantum world its fundamental laws should allow for the occurrence of *different* events under *equal* conditions. The language of probability, suitably adapted to take into account all the relevant constraints, seems therefore to be the only language capable of expressing this fundamental role of chance.

The proper framework in which a solution of the conceptual problems discussed above should be looked for is, after all, the birthplace of the quantum of action, namely phase space. It is of course clear that standard positive joint probabilities for both position and momentum having sharp given values cannot exist in phase space, because they would contradict the uncertainty principle. Wigner however, in order to represent Quantum Mechanics in phase space, introduced the functions called after his name (Wigner 1932) as pseudoprobabilities which may assume also negative values, and showed that by means of them one can compute any physically meaningful statistical property of quantum states.

A step further along this direction was made by Feynman (Feynman 1987), who has shown that, by dropping the assumption that the predictions of Quantum Mechanics can only be formulated by means of nonnegative probabilities, one can avoid the use of probability amplitudes, namely waves, in quantum mechanics. After all to the old questions about the physical meaning of probability amplitudes remains unanswered. Dirac said once “Nobody has ever seen quantum mechanical waves: only particles are detectable. Feynman is reported to have stated “It is safe to say that no one understands Quantum Mechanics”. It is undeniable in fact that probability amplitudes are source of conceptual troubles (nonlocality of particle states, superposition of macroscopic objects' states).

The difficulty of introducing directly standard positive probability amplitudes in phase space in quantum mechanics arises, as is well known, from the impossibility of assigning

precise values to incompatible variables. No joint probability density of x and p exists in phase space. However, negative probabilities - argues Feynman - have a physical interpretation.

"The idea of negative numbers - he writes - is an exceedingly fruitful mathematical invention. Today a person who balks at making a calculation in this way is considered backward or ignorant, or to have some kind of mental block. It is the purpose of this paper to point out that we have a similar strong block against negative probabilities. By discussing a number of examples, I hope to show that they are entirely rational of course, and that their use simplifies calculations and thought in a number of calculations in physics."

"If a physical theory for calculating probabilities yields a negative probability for a given situation under certain assumed conditions, we need not conclude the theory is incorrect. Two other possibilities of interpretation exist. One is that the conditions (for example, initial conditions) may not be capable of being realized in the physical world. The other possibility is that the situation for which the probability appears to be negative is one that can not be verified directly. A combination of these two, limitation of verifiability and freedom in initial conditions, may also be a solution to the apparent difficulty."

Admittedly, as he recognizes, a "strong mental block" against this extension of the probability concept is widespread. Once this has been overcome, however, the road is open for a new reformulation of Quantum Mechanics, in which the concept of probability "*waves*" is eliminated from the beginning. After all, particles and waves *do not stand on the same footing* as far as their practical detection is concerned. We have already remarked that the position of a particle assumes a sharp value as a consequence of a single interaction with a suitable detector, but we need a beam of particles to infer the sharp value of their common momentum. This means that *we never detect waves*: we only infer their existence by detecting a large number of particles.

A striking example of the usefulness of this approach is that the troubles of entangled states disappear. In fact the Wigner pseudoprobability of the singlet state of the EPR paradox is the product of the Wigner pseudoprobabilities of the two spin $\frac{1}{2}$ particles. This means no more questions about the "*superluminal transmission*" of information between them.

3.2 Classical ensembles with "Uncertainty Principle"

Feynman's program, however, is still based on the conventional formalism of QM: state vectors in Hilbert space or wave functions in coordinates' space. In fact, Wigner's function $W(q,p)$ (pseudoprobability density for sharp values q, p of incompatible variables \mathbf{q} and \mathbf{p}) is defined by the expression

$$W(q,p) = \int dy \exp(-ipy) \psi(q+(1/2)y) \psi^*(q-(1/2)y) \quad (5)$$

which contains explicitly the wave function of the state. In Feynman's approach waves are therefore still needed to start with, because pseudoprobabilities are first *expressed* in terms of wave functions, and then forgotten. We will show, however, that it is possible to express Quantum Mechanics from first principles in terms of pseudoprobabilities without ever introducing the concept of probability amplitudes. This program has been recently carried on [Cini 1999] by generalizing the formalism of classical statistical mechanics in phase space with the introduction of two postulates (*uncertainty* and *discreteness*), which impose mathematical constraints on the set of quantum variables in terms of which any physical quantity can be expressed. QM is therefore reformulated in terms of expectation values of

quantum variables as a generalization of the correspondent classical variables of classical statistical mechanics, with the introduction of a single quantum postulate.

This goal will be attained in two steps. The first step is the formulation of a classical Uncertainty Principle. We consider all the classical *ensembles* of particles in phase space with coordinate \mathbf{q} and momentum \mathbf{p} in which a given variable $\mathbf{A}(\mathbf{q},\mathbf{p})$ has a well determined value α and its conjugate variable $\mathbf{B}(\mathbf{q},\mathbf{p})$ is completely undetermined¹. *Only ensembles of this kind in fact are the classical limit of the quantum states.*

Following Moyal (1946), we will represent all the statistical properties of our ensembles, usually expressed by the joint probability distribution $P_\alpha(\mathbf{q},\mathbf{p})$, in terms of the expectation value $C_\alpha(\mathbf{k},\mathbf{x})$ (represented from now onwards by $\langle \dots \rangle_\alpha$) of the "characteristic variable" $C(\mathbf{k},\mathbf{x}) = e^{(i/\hbar)(\mathbf{k}\mathbf{q}+\mathbf{x}\mathbf{p})}$ as follows

$$\begin{aligned} P_\alpha(\mathbf{q},\mathbf{p}) &= \langle \delta(\mathbf{q}-\mathbf{q}) \delta(\mathbf{p}-\mathbf{p}) \rangle_\alpha = \\ &= (2\pi\hbar)^{-2} \iint d\mathbf{x} d\mathbf{k} \exp(-i/\hbar)(\mathbf{k}\mathbf{q}+\mathbf{x}\mathbf{p}) C_\alpha(\mathbf{k},\mathbf{x}) \end{aligned} \quad (6)$$

The requirement that all its systems have the value α of the variable \mathbf{A}

$$\langle A^2 \rangle_\alpha = \alpha^2 \quad (7)$$

entails that $C_\alpha(\mathbf{k},\mathbf{x})$ must satisfy the equation

$$\iint d\mathbf{y} d\mathbf{h} a(\mathbf{h}-\mathbf{k}, \mathbf{y}-\mathbf{x}) C_\alpha(\mathbf{h}, \mathbf{y}) = \alpha C_\alpha(\mathbf{k},\mathbf{x}) \quad (8)$$

where $a(\mathbf{k},\mathbf{x})$ is the double Fourier transform of the function $A(\mathbf{q},\mathbf{p})$.

Actually, eq. (8) is only apparently an integral equation, because it is easily reduced in terms of the variables \mathbf{A} and \mathbf{B} to a simple algebraic functional equation with solution

$$P_\alpha(\mathbf{q},\mathbf{p}) = \delta(\mathbf{A}(\mathbf{q}, \mathbf{p}) - \alpha) \quad (9)$$

In fact $P_\alpha(\mathbf{q},\mathbf{p})$ must be independent of \mathbf{B} if this variable is indetermined in the ensemble. All this may seem trivial but actually it is not. Eq. (8) will be in fact one of our starting equations for the transition to QM.

We impose now that the result (9) should be invariant under the canonical transformations generated by any arbitrary function \mathbf{L}

$$\mathbf{A}' = \mathbf{A} + \varepsilon\{\mathbf{A},\mathbf{L}\}_{\text{PB}} \quad (10)$$

Therefore the Poisson Bracket of \mathbf{A} with \mathbf{L} must satisfy

$$\langle \{\mathbf{A},\mathbf{L}\}_{\text{PB}} \rangle_\alpha = 0 \quad (11)$$

from which it follows that the characteristic function must satisfy, in addition to (9), also the equation

$$\iint d\mathbf{y} d\mathbf{h} a(\mathbf{h}-\mathbf{k}, \mathbf{y}-\mathbf{x}) (\mathbf{k}\mathbf{y}-\mathbf{h}\mathbf{x}) C_\alpha(\mathbf{h},\mathbf{y}) = 0 \quad (12)$$

for all \mathbf{k},\mathbf{x} .

Eqs. (8) (12) are the formal expression of a "classical uncertainty principle", representing the conditions to be fulfilled by classical ensembles having the property, invariant under

¹ In what follows the variables are written in boldface and their values are in ordinary typeset.

canonical transformations, that a given variable \mathbf{A} has the value α and its conjugate variable \mathbf{B} is undetermined. Up to now we are still in the domain of classical statistical mechanics.

3.3 The quantum postulate

The second, essential, step is to introduce the quantum into this scheme. This is done by imposing the fulfilment of a second postulate, based on the assumption that the founding stone of quantum theory is the experimental fact that *physical quantities exist (the action of periodic motions, the angular momentum, the energy of bound systems..) whose possible values form a discrete set, invariant under canonical transformations, characteristic of each variable in question.* This means that we should request that α belongs to a discrete spectrum independent of the phase space variables.

This feature can only be ensured if eq. (8) for the classical characteristic function $C_\alpha(k,x)$, which yields a continuous spectrum α for the values of the classical variable \mathbf{A} , is modified to become a true Fredholm homogeneous integral equation for the quantum characteristic function $C_i(k,y)$ with a nonseparable kernel $g(ky-hx)$, allowing for the existence of a discrete set of eigenvalues α_i .

$$\iint dx dh a(h-k, y-x) g(ky-hx) C_i(h, y) = \alpha_i C_i(k, y) \quad (13)$$

Similarly, eq.(12) expressing the uncertainty principle between the classical variables \mathbf{A} and \mathbf{B} should be changed into

$$\iint dy dh a(h-k, y-x) f(ky-hx) C_i(h, y) = 0 \quad (14)$$

for the quantum characteristic function $C_i(k,x)$ of the ensemble characterized by one of the values α_i of the quantum variable \mathbf{A} and by the complete indeterminacy of its quantum conjugate variable \mathbf{B} . The functions $g()$ and $f()$ should be determined by imposing new self consistent rules for the quantum variables involved.

The two eqs (13) (14), however, cannot be obtained from (7) and (11) as in the classical case by ordinary commuting numbers. In fact the only way to obtain (13) (14) is to replace the classical characteristic variables $C(k,x)$ obeying the standard rule of multiplication of exponentials with quantum variables $C(k,x)$ having the property

$$(1/2)[C(k,x) C(h,y) + C(h,y)C(k,x)] = g(ky-hx)C(k+h,x+y) \quad (15)$$

and to replace their classical Poisson bracket with the Quantum Poisson Bracket

$$\{C(k,x), C(h,y)\}_{\text{QPB}} = f(ky-hx) C[(k+h), (y+x)] \quad (16)$$

This means that, if we want to allow for the existence of discrete values of at least one variable \mathbf{L} we are forced to represent all the variables \mathbf{A} by means of noncommuting Dirac q-numbers. This means that the mathematical nature of the entities needed to represent the quantum variables is a consequence of the physical assumption of the discreteness of quantum variables and not viceversa, as the conventional view of reality underlying the conventional axiomatic formulation of Quantum Mechanics assumes.

With (15) (16) the functions $f()$ and $g()$ turn out to have the expressions

$$g(ky-hx) = \cos[(ky-hx)/2\hbar] \quad ; \quad f(ky-hx) = (2/\hbar) \sin[(ky-hx)/2\hbar] \quad (17)$$

As expected, the quantum variables $C(k,x)$ with the properties (15) (16) turn out to have the same exponential form of classical statistical mechanics where the classical variables q and p are replaced by quantum variables q and p satisfying the commutation relations

$$[q,p]=i\hbar \quad (18)$$

of the standard variables of Quantum Mechanics

From the solution of equations (13) (14) one immediately obtains (by simple Fourier transform) the pseudoprobability $W_i(q,p)$ corresponding to the quantum characteristic function $C_i(q,p)$ of the ensemble. This pseudoprobability coincides with the Wigner function obtained from the standard wave QM wave function of the state. It is important to mention that all pseudoprobabilities satisfy the condition

$$\iint dq dp W_i(q,p) W_i(q,p) = (2\pi\hbar)^{-1} \quad (19)$$

which expresses the uncertainty principle in the reformulation of quantum theory in phase space. It is remarkable that this principle is given by an equality, thus eliminating the ambiguity of the Heisenberg inequality due to the presence of the two physically different terms appearing in eq. (1)

3.4 Field quantization in phase space and wave/particle duality

These results however leaved some conceptual problems still open. First of all, once the Schrödinger waves have been eliminated from Quantum Mechanics, how does one generalize its principles to Quantum Field Theory? One should not forget that, historically, QED was invented by Dirac (Dirac 1927) by submitting "first quantized" Schrödinger amplitudes to the procedure of "second quantization". If no "first quantized" probability amplitudes exist any more how does one proceed? And, secondly, isn't one throwing away the baby with the dirty water by forgetting that after all a quantum field must still show some of the wavelike properties of its classical limit?

A second paper [Cini 2003] has been therefore devoted to answer to these questions, leading to the conclusion that: (a) one should not start from nonrelativistic quantum mechanics in order to formulate quantum field theory, but viceversa; (b) the wavelike behaviour of the quanta of a quantum field is, as already Pascual Jordan had understood in 1926 [Born, Heisenberg, Jordan 1926], a straightforward consequence of imposing the Einstein property of discreteness to the intensity of a classical field - clearly a nonlocal physical entity - which exists objectively in ordinary three dimensional space.

It is appropriate to recall that for Jordan, in fact, it is quantization which brings into existence particles, both photons and electrons. According to him, therefore, rather than trying to explain phenomena like diffraction and interference of single particles as properties of "probability waves" one should simply view them as primary properties of the field of which they represent the *quanta*. "These considerations show - we read in his paper "On waves and corpuscles in quantum mechanics" [Jordan 1927] - that the quantized field is equivalent, in all its physical properties and especially with respect to its intensity fluctuations, to a corpuscular system (with a symmetric eigenfunction)".

The derivation of Wigner functions from the principles of uncertainty and discreteness illustrated in the previous paragraph provides the formalism for deducing the kind of wave/particle duality suggested by Jordan (and forgotten by the physicist's community

since then) by simply imposing Einstein's quantization to the states of a classical field represented by means of statistical ensembles in the phase spaces of its normal modes.

Following the procedure sketched in the previous paragraph, we introduce a classical statistical ensemble for the r -th radiation oscillator of the field's normal modes defined by the constraint that the intensity $N_r(q,p)$ has with certainty a given value v_r . The equations (9) (11) remain valid, provided the variable \mathbf{A} with its value α is replaced by the intensity \mathbf{N} with its value v and the conjugated variable \mathbf{B} is replaced by the corresponding phase θ of each normal mode (we omit from now onwards the index r). Our procedure of field quantization will be based on the Einstein assumption of the existence of discrete field quanta. More precisely we *assume* that the spectrum of the quantum variable N of each field oscillator should be discrete. Eqs. (15) (16) remain unchanged and express now the result *that, the quantum variables should be represented by means of non commuting quantities (Dirac's q -numbers). Quantization is therefore now a consequence of the physical property of the existence of field quanta, and not viceversa.*

The field's states with a given number of quanta can now be represented by going from the quantum variables q, p to the Dirac complex variables a, a^* expressed in terms of each wave's intensity N and phase θ by means of their standard expressions

$$a^* = N^{1/2} \exp(-i\theta/\hbar) \quad a = \exp(i\theta/\hbar) N^{1/2} \quad (20)$$

The eigenvalue equations (13) (14) can be rewritten for the characteristic functions $C_n(\beta, \beta^*)$ expressed in terms of the new variables β, β^* related to k,x and h,y by means of the same relations (20). These equations can be solved to give the eigenvalues v_n of the quantum variable N and their characteristic functions $C_n(\beta, \beta^*)$ yielding

$$v_n = n + (1/2) \quad (21)$$

This result is expected, but remarkable, because it has been obtained by solving our new integral equations without any reference to Schrödinger wavefunctions. It is also easy with this formalism to treat the field's coherent states, as well as the processes of emission and absorption of photons from a source to reproduce the results obtained by Dirac in his seminal paper on the foundations of quantum electrodynamics. It turns out of course that the absorption rate is proportional to n_r and the emission rate to n_r+1 (Einstein's laws)

3.5 Conclusions

The main result of the reversal of the order of quantization from non relativistic quantum mechanics to quantum field theory gives a clear physical foundation to the mathematical nature of all quantum variables. The basic formal rules of quantum mechanics follow in this way from the Einstein postulate of the existence of field's quanta. The main conceptual result of this approach is therefore the clarification of the basic notion of wave/particle duality, which follows from this postulate, and simply reflects the dual nature of the quantum field as a unique physical entity objectively existing in ordinary three dimensional space (or ordinary four dimensional relativistic space, when is the case). From Jordan's point of view, in fact, the wavelike behaviour of any field's state with any number of discrete quanta simply reflects the property of a physical nonlocal entity which exists objectively in ordinary three dimensional space.

This goal has been achieved by imposing two requirements to the characteristic function (Moyal 1949) of the classical ensembles of the field's normal modes. The first one is that the

probability distribution of the ensembles should be invariant under canonical transformations. The second requirement is quantization.

These two requirements are a reformulation of the principles introduced in the preceding nonrelativistic formulation of quantum mechanics where it was shown that the Wigner functions of the states of the one dimensional motion of a single particle can be directly derived without ever introducing Schrödinger wave functions. They lead to the two equations (18) and (21) whose solutions yield directly the quantum characteristic functions of the states of each mode, which turn out to be the double Fourier transforms of their Wigner functions. In the derivation of these equations one discovers that the field variables cannot be represented by ordinary numbers but should be represented by means of noncommuting mathematical objects.

With the direct construction of the Wigner functions of the states of quantum fields, the deBroglie-Schrödinger waves are thus eliminated from the formulation of quantum field theory. This means that, once that their nature of mathematical auxiliary tools has been recognized, the endless discussions about their queer physical properties, such as the nature of long distance EPR correlations between two or more particles or the meaning of the superposition of macroscopic states, become meaningless as those about the queer properties of the aether after its elimination declared by the theory of relativity.

Furthermore it supports the view that the most adequate representation of the random character of quantum phenomena ought to be based on Wigner-Feynman pseudoprobabilities in phase space, in which the constraints of the uncertainty principle are embodied, rather than insisting in representing them as events occurring in different spaces, (e.g. configuration *or* momentum) ruled by their correlated but separate classical probability laws. This view still meets a widespread resistance on the grounds that pseudoprobabilities are not positive definite, but is starting to acquire consensus in some domains of physics such as quantum optics (Leibfried et al 1988) leading even to a proposal for their experimental determination (Luttinger et al 1997).

Finally, the direct deduction of Wigner functions from first principles solves a puzzling unanswered question which has been worrying all the beginners approaching the study of our fundamental theory of matter, all along its 75 years of life, namely "Why should one take the modulus squared of a wave amplitude in order to obtain the corresponding probability?" We can now say that there is no longer need of an answer, because there is no longer need to ask the question.

4. References

- Aspect A., Dalibard J., Roger G. - Phys. Rev. Lett. 49, 1804, 1982
Bell J, 1964: Physica, 1, 194.
Blanchard P., Cini M. and Serva M, 1992: *Ideas and methods in quantum and statistical physics. In memory of Raphael Hoegh-Krohn* (S. Albeverio et al. eds.) Cambridge University Press, p. 132.
Bohr N (1958) - Atomic Physics and Human Knowledge - J. Wiley & Sons, London, 1958, pag.44.
Bohr N, (1948)- Dialectica, 2, 312 (1948).
Bohr N, *ibid.* pag.50
Bohr N. (1935) - Phys. Rev. 48, 696
Born M, Heisenberg W, Jordan P., *Zeit.f.Phys.* 35,557 (1926)

- Cini M. 1983, Nuovo Cim. 73B,27: Nature, 302,307
- Cini M. 2003; Ann of physics, 305, 83
- Cini M. and Serva M. 1990: Found. of Phys. Lett. 3,129.
- Cini M. and Serva M. 1992: Phys. Lett. A 167, 319.
- Cini M., De Maria M., Mattioli G., Nicolò F., 1979: Found. of Phys. 9,479
- Cini M., Lévy-Leblond J.M. (eds) 1991: *Quantum theory without reduction*, A. Hilger, London.
- Cini M.,1999: Ann. of Phys. 273, 199.
- Dirac PM 1927; Proc. Royal Soc.114, 243
- Einstein A. Podolsky B. Rosen N. (1935) - Phys Rev.47,777(1935).
- Everett E. (1973), 'The Theory of the Universal Wave Function', in B. De Witt and N. Graham (eds.), *The Many-Worlds Interpretation of Quantum Mechanics*,
- Feynman R.P., 1987: in: *Quantum Implications* (B.J.Hiley, F.D.Peats eds.) Routledge & Kegan, London, p.285
- Gottfried K., 1966: *Quantum Mechanics*, J.Wiley, New York, sect. 20
- Jammer M. *Conceptual developments of Quantum Mechanics* (1966) *The Philosophy of Quantum Mechanics* (1974),
- Jordan P 1027; Z. Phys. 45, 765.
- Leibfried D, Pfau T, Monroe C, 1988 *Phys. Today*, 22,vol. 51,n.4 and cover. Lutterbach LG andDavidovich L, 1997 PRL 78, 2547 (1997)
- Moyal, 1949: *Math.Proc.Cambridge Phil. Soc.* 45,99
- Schrodinger E 1935, *Naturwissenschaften*, 49, 53 (1935);
- Scully M.O., Walther H. and Schleich W. 1994: *Phys.Rev.A*, 49,182.
- Vaidman L 2007. www.associazioneasia.it/cgi-bin/adon.cgi?act=doc&doc=278
- Wheeler J., Zurek W.(eds) 1983: *Quantum Theory and measurement*, Princeton University Press, 1983.
- Wigner E., 1932: *Phys. Rev.* 40,479.

The Bicomplex Heisenberg Uncertainty Principle

Raphaël Gervais Lavoie¹ and Dominic Rochon²

¹*Département de Physique, de Génie Physique et D'optique, Université Laval*

²*Département de Mathématiques et D'informatique, Université du Québec à Trois-Rivières
Canada*

1. Introduction

Quantum mechanics is one of the two fundamental pillar of modern physics. The success of the theory can be found everywhere in our everyday life and essentially in every new product that we build. We just have to remember that every semiconductor chip usually uses a quantum behavior in an essential way, for example quantum tunneling, to work. Until now, none of the thousand of experiments realized have succeeded to contradicted or to find a problem with the predictions given by quantum mechanics.

However, in spite of this incredible success, many profound questions are still open. For example, we have some problems understanding the measurement, the coherence and the decoherence process, as well as the interpretation of what the theory tell us about the world we live in (Schlosshauer, 2005).

Among the possible ways of investigation that we have, we think that stressing the foundations of the theory at the level of the mathematical structure, on which the theory stands, could be a good way to understand why and how the theory works. The mathematical structure of quantum mechanics consists in Hilbert spaces defined over the field of complex numbers (Birkhoff & Von Neumann, 1936). The success of the theory has led a number of investigators, over many decades, to look for general principles or arguments that would lead quite inescapably to the complex Hilbert space structure. It has been argued (Stueckelberg, 1960; Stueckelberg & Guenin, 1961), for instance, that the formulation of an uncertainty principle, heavily motivated by experiment, implies that a real Hilbert space can in fact be endowed with a complex structure. The proof, however, involves a number of additional hypotheses that may not be so directly connected with experiment. In fact Reichenbach (Reichenbach, 1944) has shown that a theory is not straightforwardly deduced from experiments, but rather arrived at by a process involving a good deal of instinctive inferences. This was also pointed out more recently by Penrose (Penrose, 2005, p. 59);

In the development of mathematical ideas, one important initial driving force has always been to find mathematical structures that accurately mirror the behaviour of the physical world. But it is normally not possible to examine the physical world itself in such precise detail that appropriately clear-cut mathematical notions can be abstracted directly from it.

Moreover, in the last decade, some of the efforts to derive the complex Hilbert space structure have focused on information-theoretic principles (Clifton et al., 2003; Fuchs, 2002). The general principles assumed at the outset are no doubt attractive, but yet open to questioning (Marchildon, 2004).

The upshot is that there is no compelling argument restricting the number system on which quantum mechanics is built to the field of complex numbers. The justification of the theory lies rather in its ability to correctly describe and explain experiments.

We think that all this justifies the investigation of a quantum mechanics standing on a different algebra than the usual one, not necessarily in the aim of replacing the actual theory, but in the aim of a better understanding of the actual theory by meticulously comparing the two descriptions. Moreover, it does not exclude that a quantum mechanics standing on a different algebra can end with some new predictions.

This is with those things in mind that we would like to introduce this chapter on *bicomplex quantum mechanics* and on the *bicomplex Heisenberg uncertainty principle*.

In section 2, we present the bicomplex numbers, that are a generalization of complex numbers by means of entities specified by four real numbers. Bicomplex numbers are commutative but do not form a division algebra. Division algebras do not have zero divisors, that is, nonzero elements whose product is zero. We also present some algebraic properties of bicomplex numbers, modules, scalar product and linear operator. In the recent years, bicomplex numbers have found application in quantum mechanics (Gervais Lavoie et al., 2010b; Rochon & Tremblay, 2004; 2006), in pure mathematics (Charak et al., 2009; Gervais Lavoie et al., 2010a; 2011; Rochon, 2003; 2004; Rochon & Shapiro, 2004) as well as in the construction of three dimensional fractals (Garant-Pelletier & Rochon, 2009; Martineau & Rochon, 2005; Rochon, 2000).

The section 3 presents some important results on infinite-dimensional bicomplex Hilbert spaces.

In section 4, we give a sketch of some fundamental aspects of bicomplex quantum mechanics. We also present our solution for the problem of the bicomplex harmonic oscillator. These results are already given in (Gervais Lavoie et al., 2010b), but we present them here with a new approach, the differential one. We also plot some of the eigenfunctions that we found and give some new representation of them by means of hyperbolic sinus and cosinus functions.

Section 5 is the main part of this chapter. We work out, in details, the bicomplex Heisenberg uncertainty principle. This will give an explicit and fully detailed example of the kind of computation that arise in bicomplex quantum mechanics.

2. Preliminaries

This section summarizes basic properties of bicomplex numbers and modules defined over them. The notions of scalar product and linear operators are also introduced. Proofs and additional material can be found in (Gervais Lavoie et al., 2010a;b; 2011; Price, 1991; Rochon & Shapiro, 2004; Rochon & Tremblay, 2004; 2006).

2.1 Bicomplex numbers

The set \mathbb{T} of *bicomplex numbers* can be defined essentially in two equivalent ways as

$$\mathbb{T} := \{w = w_e + w_{\mathbf{i}_1}\mathbf{i}_1 + w_{\mathbf{i}_2}\mathbf{i}_2 + w_{\mathbf{j}}\mathbf{j} \mid w_e, w_{\mathbf{i}_1}, w_{\mathbf{i}_2}, w_{\mathbf{j}} \in \mathbb{R}\} \quad (1)$$

$$\equiv \{w = z + z'\mathbf{i}_2 \mid z, z' \in \mathbb{C}(\mathbf{i}_1)\}, \quad (2)$$

where \mathbf{i}_1 , \mathbf{i}_2 and \mathbf{j} are (complex) *imaginary* and *hyperbolic* units such that

$$\mathbf{i}_1^2 = -1 = \mathbf{i}_2^2 \quad \text{and} \quad \mathbf{j}^2 = 1. \quad (3)$$

The product of units is commutative and defined as

$$\mathbf{i}_1 \mathbf{i}_2 = \mathbf{j}, \quad \mathbf{i}_1 \mathbf{j} = -\mathbf{i}_2 \quad \text{and} \quad \mathbf{i}_2 \mathbf{j} = -\mathbf{i}_1. \quad (4)$$

It is obvious that definition (1) and (2) imply that $z = w_e + w_{\mathbf{i}_1} \mathbf{i}_1$ and $z' = w_{\mathbf{i}_2} + w_{\mathbf{j}} \mathbf{i}_1$ are both in $\mathbb{C}(\mathbf{i}_1)$.

Three important subsets of \mathbb{T} can be specified as

$$\mathbb{C}(\mathbf{i}_k) := \{x + y\mathbf{i}_k \mid x, y \in \mathbb{R}\}, \quad k = 1, 2; \quad (5)$$

$$\mathbb{D} := \{x + y\mathbf{j} \mid x, y \in \mathbb{R}\}. \quad (6)$$

Each of the sets $\mathbb{C}(\mathbf{i}_k)$ is isomorphic to the field of complex numbers, while \mathbb{D} is the set of so-called *hyperbolic numbers*.

With the addition and multiplication of two bicomplex numbers defined in the obvious way, the set \mathbb{T} makes up a commutative ring.

2.1.1 Complexification

In addition to the formal definition, it is instructive to see how the set of bicomplex numbers can be construct. Let us define the action \xrightarrow{k} that add up an imaginary part (with respect to k) to all the real variables. For $x, y \in \mathbb{R}$, we thus have

$$x \xrightarrow{\mathbf{i}} x + y\mathbf{i} \in \mathbb{C}, \quad (7)$$

$$x \xrightarrow{\mathbf{i}_1} x + y\mathbf{i}_1 \in \mathbb{C}(\mathbf{i}_1) \simeq \mathbb{C}, \quad (8)$$

$$x \xrightarrow{\mathbf{i}_2} x + y\mathbf{i}_2 \in \mathbb{C}(\mathbf{i}_2) \simeq \mathbb{C}. \quad (9)$$

The action \xrightarrow{k} will be call a *complexification*. Let us now applied a complexification on $x + y\mathbf{i}_1$. There are essentially two possibilities, the first one is ($s, t \in \mathbb{R}$)

$$x + y\mathbf{i}_1 \xrightarrow{\mathbf{i}_1} (x + s\mathbf{i}_1) + (y + t\mathbf{i}_1)\mathbf{i}_1 = (x - t) + (s + y)\mathbf{i}_1 \in \mathbb{C}(\mathbf{i}_1). \quad (10)$$

This complexification is trivial in the sense that it maps $\mathbb{C}(\mathbf{i}_1)$ to $\mathbb{C}(\mathbf{i}_1)$. The second one is more interesting

$$x + y\mathbf{i}_1 \xrightarrow{\mathbf{i}_2} (x + s\mathbf{i}_2) + (y + t\mathbf{i}_2)\mathbf{i}_1 = x + y\mathbf{i}_1 + s\mathbf{i}_2 + t\mathbf{i}_2\mathbf{i}_1. \quad (11)$$

Here, because \mathbf{i}_1 and \mathbf{i}_2 are two independent imaginary units, we cannot write $\mathbf{i}_2\mathbf{i}_1 = -1$. However, one can remark that

$$(\mathbf{i}_2\mathbf{i}_1)^2 = \mathbf{i}_2\mathbf{i}_1\mathbf{i}_2\mathbf{i}_1 = \mathbf{i}_2^2\mathbf{i}_1^2 = (-1)(-1) = 1. \quad (12)$$

This means that $\mathbf{i}_2\mathbf{i}_1$ have the same behavior as an hyperbolic unit and then, we can write $\mathbf{j} := \mathbf{i}_2\mathbf{i}_1 = \mathbf{i}_1\mathbf{i}_2$. We finally ends with

$$x + y\mathbf{i}_1 \xrightarrow{\mathbf{i}_2} x + y\mathbf{i}_1 + s\mathbf{i}_2 + t\mathbf{j}, \quad (13)$$

which is the set of bicomplex numbers.

The complexification process can be applied again to generate the *tricomplex numbers*, and so on. For n successive complexification, we talk of a *multicomplex number* of order n , and we noted it by \mathbb{MC}_n (Garant-Pelletier & Rochon, 2009; Price, 1991; Vajiac & Vajiac, to appear). Then, it is not hard to see that

$$\mathbb{MC}_0 \equiv \mathbb{R}, \quad \mathbb{MC}_1 \equiv \mathbb{C} \quad \text{and} \quad \mathbb{MC}_2 \equiv \mathbb{T}. \quad (14)$$

For an arbitrary multicomplex number $s \in \mathbb{MC}_{n>0}$, s is 2^n -dimensional (in the sense that we need 2^n real numbers to specify it), posses 2^{n-1} independent imaginary units, and $2^{n-1} - 1$ independent hyperbolic units.

The set \mathbb{T} of bicomplex numbers can also be construct by applying the complexification process on the set of hyperbolic numbers, or by applying an *hyperbolisation process* (the process that add up an hyperbolic term instead of a imaginary one) on the set of complex numbers.

In Fig. 1, we give a sketch of some generalization of the real numbers. The set \mathbb{P} stand for the set of *parabolic* or *dual* numbers defined by

$$\mathbb{P} := \{ p = x + y\varepsilon \mid x, y \in \mathbb{R}, \quad \varepsilon^2 = 0 \}. \quad (15)$$

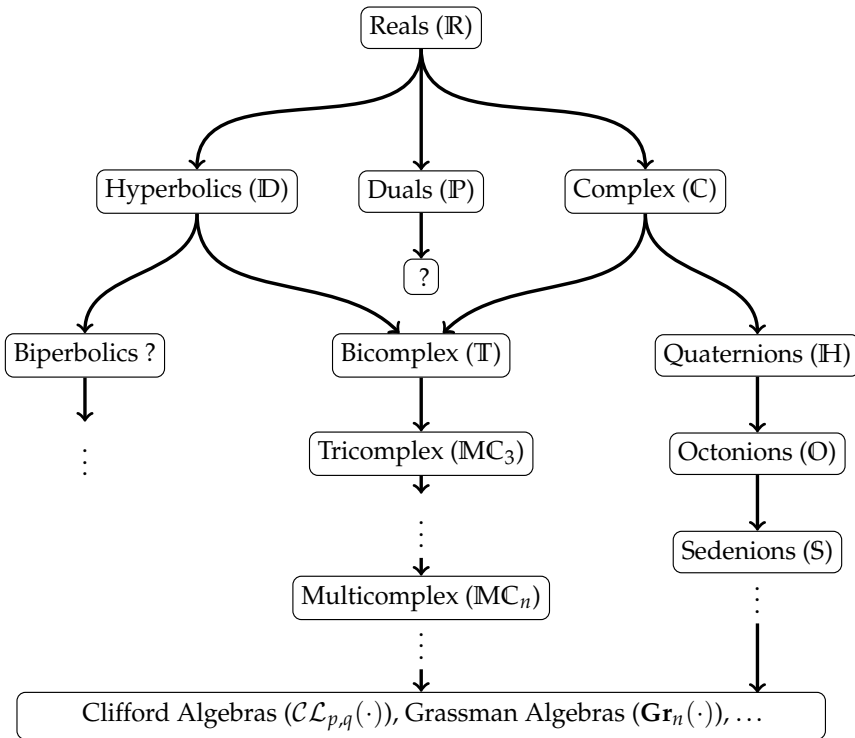

Fig. 1. Generalization of real numbers

2.1.2 Algebraic properties of bicomplex numbers

Bicomplex algebra is considerably simplified by the introduction of two bicomplex numbers \mathbf{e}_1 and \mathbf{e}_2 defined as

$$\mathbf{e}_1 := \frac{1 + \mathbf{j}}{2} \quad \text{and} \quad \mathbf{e}_2 := \frac{1 - \mathbf{j}}{2}. \quad (16)$$

One easily checks that

$$\mathbf{e}_1^2 = \mathbf{e}_1, \quad \mathbf{e}_2^2 = \mathbf{e}_2, \quad \mathbf{e}_1 + \mathbf{e}_2 = 1 \quad \text{and} \quad \mathbf{e}_1 \mathbf{e}_2 = 0. \quad (17)$$

Any bicomplex number w can be written uniquely as

$$w = z_{\hat{1}} \mathbf{e}_1 + z_{\hat{2}} \mathbf{e}_2, \quad (18)$$

where $z_{\hat{1}}$ and $z_{\hat{2}}$ both belong to $\mathbb{C}(\mathbf{i}_1)$. Specifically,

$$z_{\hat{1}} = (w_e + w_j) + (w_{i_1} - w_{i_2}) \mathbf{i}_1 \quad \text{and} \quad z_{\hat{2}} = (w_e - w_j) + (w_{i_1} + w_{i_2}) \mathbf{i}_1. \quad (19)$$

The numbers \mathbf{e}_1 and \mathbf{e}_2 make up the so-called *idempotent basis* of the bicomplex numbers (Price, 1991). Note that the last of (17) illustrates the fact that \mathbb{T} has zero divisors which are nonzero elements whose product is zero. The caret notation ($\hat{1}$ and $\hat{2}$) will be used systematically in connection with idempotent decompositions, with the purpose of easily distinguishing different types of indices.

As a consequence of (17) and (18), one can check that if $\sqrt[n]{z_{\hat{1}}}$ is an n th root of $z_{\hat{1}}$ and $\sqrt[n]{z_{\hat{2}}}$ is an n th root of $z_{\hat{2}}$, then $\sqrt[n]{z_{\hat{1}}} \mathbf{e}_1 + \sqrt[n]{z_{\hat{2}}} \mathbf{e}_2$ is an n th root of w .

The uniqueness of the idempotent decomposition allows the introduction of two projection operators as

$$P_1 : w \in \mathbb{T} \mapsto z_{\hat{1}} \in \mathbb{C}(\mathbf{i}_1), \quad (20)$$

$$P_2 : w \in \mathbb{T} \mapsto z_{\hat{2}} \in \mathbb{C}(\mathbf{i}_1). \quad (21)$$

The P_k ($k = 1, 2$) satisfy

$$[P_k]^2 = P_k, \quad P_1 \mathbf{e}_1 + P_2 \mathbf{e}_2 = \mathbf{Id}, \quad (22)$$

and, for $s, t \in \mathbb{T}$,

$$P_k(s + t) = P_k(s) + P_k(t) \quad \text{and} \quad P_k(s \cdot t) = P_k(s) \cdot P_k(t). \quad (23)$$

The product of two bicomplex numbers w and w' can be written in the idempotent basis as

$$w \cdot w' = (z_{\hat{1}} \mathbf{e}_1 + z_{\hat{2}} \mathbf{e}_2) \cdot (z'_{\hat{1}} \mathbf{e}_1 + z'_{\hat{2}} \mathbf{e}_2) = z_{\hat{1}} z'_{\hat{1}} \mathbf{e}_1 + z_{\hat{2}} z'_{\hat{2}} \mathbf{e}_2. \quad (24)$$

Since 1 is uniquely decomposed as $\mathbf{e}_1 + \mathbf{e}_2$, we can see that $w \cdot w' = 1$ if and only if $z_{\hat{1}} z'_{\hat{1}} = 1 = z_{\hat{2}} z'_{\hat{2}}$. Thus w has an inverse if and only if $z_{\hat{1}} \neq 0 \neq z_{\hat{2}}$, and the inverse w^{-1} is then equal to $z_{\hat{1}}^{-1} \mathbf{e}_1 + z_{\hat{2}}^{-1} \mathbf{e}_2$. A nonzero w that does not have an inverse has the property that either $z_{\hat{1}} = 0$ or $z_{\hat{2}} = 0$, and such a w is a divisor of zero. Zero divisors make up the so-called *null cone* (\mathcal{NC}). That terminology comes from the fact that when w is written as $z + z' \mathbf{i}_2$, zero divisors are such that $z^2 + (z')^2 = 0$.

2.1.3 Bicomplex numbers are not quaternions

We would like to point out that even if bicomplex numbers and quaternions are both given by four real elements, they form two completely different algebras. First, bicomplex numbers are commutative while quaternions are not. Secondly, quaternion numbers form a division algebra, but not the bicomplex numbers. A division algebra is characterized by the fact that every nonzero element have a multiplicative inverse. Let us give the multiplication table of the two algebra to clearly see the difference. Let $x_1 \dots x_4 \in \mathbb{R}$,

Bicomplex \mathbb{T}	Quaternions \mathbb{H}																																																		
$x_1 + x_2 \mathbf{i}_1 + x_3 \mathbf{i}_2 + x_4 \mathbf{j}$,	$x_1 + x_2 \mathbf{i} + x_3 \mathbf{j} + x_4 \mathbf{k}$,																																																		
$\exists a, b \in \mathbb{T} \mid a \cdot b = 0, a \neq 0 \neq b$,	$\forall a, b \in \mathbb{H} \mid a \cdot b = 0 \Leftrightarrow a = 0 \text{ or } b = 0$,																																																		
<table border="1" style="border-collapse: collapse; text-align: center; width: 100%;"> <tr><td style="padding: 2px 5px;">·</td><td style="padding: 2px 5px;">1</td><td style="padding: 2px 5px;">\mathbf{i}_1</td><td style="padding: 2px 5px;">\mathbf{i}_2</td><td style="padding: 2px 5px;">\mathbf{j}</td></tr> <tr><td style="padding: 2px 5px;">1</td><td style="padding: 2px 5px;">1</td><td style="padding: 2px 5px;">\mathbf{i}_1</td><td style="padding: 2px 5px;">\mathbf{i}_2</td><td style="padding: 2px 5px;">\mathbf{j}</td></tr> <tr><td style="padding: 2px 5px;">\mathbf{i}_1</td><td style="padding: 2px 5px;">\mathbf{i}_1</td><td style="padding: 2px 5px;">-1</td><td style="padding: 2px 5px;">\mathbf{j}</td><td style="padding: 2px 5px;">$-\mathbf{i}_2$</td></tr> <tr><td style="padding: 2px 5px;">\mathbf{i}_2</td><td style="padding: 2px 5px;">\mathbf{i}_2</td><td style="padding: 2px 5px;">\mathbf{j}</td><td style="padding: 2px 5px;">-1</td><td style="padding: 2px 5px;">$-\mathbf{i}_1$</td></tr> <tr><td style="padding: 2px 5px;">\mathbf{j}</td><td style="padding: 2px 5px;">\mathbf{j}</td><td style="padding: 2px 5px;">$-\mathbf{i}_2$</td><td style="padding: 2px 5px;">$-\mathbf{i}_1$</td><td style="padding: 2px 5px;">1</td></tr> </table>	·	1	\mathbf{i}_1	\mathbf{i}_2	\mathbf{j}	1	1	\mathbf{i}_1	\mathbf{i}_2	\mathbf{j}	\mathbf{i}_1	\mathbf{i}_1	-1	\mathbf{j}	$-\mathbf{i}_2$	\mathbf{i}_2	\mathbf{i}_2	\mathbf{j}	-1	$-\mathbf{i}_1$	\mathbf{j}	\mathbf{j}	$-\mathbf{i}_2$	$-\mathbf{i}_1$	1	<table border="1" style="border-collapse: collapse; text-align: center; width: 100%;"> <tr><td style="padding: 2px 5px;">·</td><td style="padding: 2px 5px;">1</td><td style="padding: 2px 5px;">\mathbf{i}</td><td style="padding: 2px 5px;">\mathbf{j}</td><td style="padding: 2px 5px;">\mathbf{k}</td></tr> <tr><td style="padding: 2px 5px;">1</td><td style="padding: 2px 5px;">1</td><td style="padding: 2px 5px;">\mathbf{i}</td><td style="padding: 2px 5px;">\mathbf{j}</td><td style="padding: 2px 5px;">\mathbf{k}</td></tr> <tr><td style="padding: 2px 5px;">\mathbf{i}</td><td style="padding: 2px 5px;">\mathbf{i}</td><td style="padding: 2px 5px;">-1</td><td style="padding: 2px 5px;">\mathbf{k}</td><td style="padding: 2px 5px;">$-\mathbf{j}$</td></tr> <tr><td style="padding: 2px 5px;">\mathbf{j}</td><td style="padding: 2px 5px;">\mathbf{j}</td><td style="padding: 2px 5px;">$-\mathbf{k}$</td><td style="padding: 2px 5px;">-1</td><td style="padding: 2px 5px;">\mathbf{i}</td></tr> <tr><td style="padding: 2px 5px;">\mathbf{k}</td><td style="padding: 2px 5px;">\mathbf{k}</td><td style="padding: 2px 5px;">\mathbf{j}</td><td style="padding: 2px 5px;">$-\mathbf{i}$</td><td style="padding: 2px 5px;">-1</td></tr> </table>	·	1	\mathbf{i}	\mathbf{j}	\mathbf{k}	1	1	\mathbf{i}	\mathbf{j}	\mathbf{k}	\mathbf{i}	\mathbf{i}	-1	\mathbf{k}	$-\mathbf{j}$	\mathbf{j}	\mathbf{j}	$-\mathbf{k}$	-1	\mathbf{i}	\mathbf{k}	\mathbf{k}	\mathbf{j}	$-\mathbf{i}$	-1
·	1	\mathbf{i}_1	\mathbf{i}_2	\mathbf{j}																																															
1	1	\mathbf{i}_1	\mathbf{i}_2	\mathbf{j}																																															
\mathbf{i}_1	\mathbf{i}_1	-1	\mathbf{j}	$-\mathbf{i}_2$																																															
\mathbf{i}_2	\mathbf{i}_2	\mathbf{j}	-1	$-\mathbf{i}_1$																																															
\mathbf{j}	\mathbf{j}	$-\mathbf{i}_2$	$-\mathbf{i}_1$	1																																															
·	1	\mathbf{i}	\mathbf{j}	\mathbf{k}																																															
1	1	\mathbf{i}	\mathbf{j}	\mathbf{k}																																															
\mathbf{i}	\mathbf{i}	-1	\mathbf{k}	$-\mathbf{j}$																																															
\mathbf{j}	\mathbf{j}	$-\mathbf{k}$	-1	\mathbf{i}																																															
\mathbf{k}	\mathbf{k}	\mathbf{j}	$-\mathbf{i}$	-1																																															

For a complete treatment of quantum mechanics define over the field of quaternions, the reader can consult (Adler, 1995).

2.1.4 Conjugation of bicomplex numbers

Three different conjugation can be defines on bicomplex numbers, consistent with the fact that we have two independent imaginary unit (we can conjugate one unit, the other or the two at the same time). However, in the present work, we will consider only one of them.

We define the conjugate w^\dagger of the bicomplex number $w = z_1 \mathbf{e}_1 + z_2 \mathbf{e}_2$ as

$$w^\dagger := \bar{z}_1 \mathbf{e}_1 + \bar{z}_2 \mathbf{e}_2, \quad (26)$$

where the bar denotes the usual complex conjugation on $\mathbb{C}(\mathbf{i}_1)$. Operation w^\dagger was denoted by $w^{\dagger 3}$ in (Gervais Lavoie et al., 2010a; 2011; Rochon & Tremblay, 2004; 2006), consistent with the fact that at least two other types of conjugation can be defined with bicomplex numbers. Making use of (24), we immediately see that

$$w \cdot w^\dagger = z_1 \bar{z}_1 \mathbf{e}_1 + z_2 \bar{z}_2 \mathbf{e}_2. \quad (27)$$

Furthermore, for any $s, t \in \mathbb{T}$,

$$(s + t)^\dagger = s^\dagger + t^\dagger, \quad (s^\dagger)^\dagger = s \quad \text{and} \quad (s \cdot t)^\dagger = s^\dagger \cdot t^\dagger. \quad (28)$$

It can be noted that with our choice of conjugation, we have $\mathbf{j}^\dagger = (\bar{\mathbf{i}}_2)(\bar{\mathbf{i}}_1) = (-\mathbf{i}_2)(-\mathbf{i}_1) = \mathbf{j}$ (another choice of conjugation would have lead us to a different expression here). This also imply that $\mathbf{e}_k^\dagger = \mathbf{e}_k$, $k = 1, 2$.

The real modulus $|w|$ of a bicomplex number w can be defined as

$$|w| := \sqrt{w_e^2 + w_{\mathbf{i}_1}^2 + w_{\mathbf{i}_2}^2 + w_{\mathbf{j}}^2} = \sqrt{(z_1 \bar{z}_1 + z_2 \bar{z}_2)/2} = \sqrt{\text{Re}(w \cdot w^\dagger)}. \quad (29)$$

This coincides with the Euclidean norm on \mathbb{R}^4 . Clearly, $|\cdot| : \mathbb{T} \rightarrow \mathbb{R}$, $|w| \geq 0$, with $|w| = 0$ if and only if $w = 0$ and for any $s, t \in \mathbb{T}$,

$$|s + t| \leq |s| + |t| \quad \text{and} \quad |\lambda \cdot t| = |\lambda| \cdot |t|, \quad (30)$$

for $\lambda \in \mathbb{C}(\mathbf{i}_1)$ or $\mathbb{C}(\mathbf{i}_2)$. Moreover,

$$|s \cdot t| \leq \sqrt{2}|s| \cdot |t|. \quad (31)$$

As the reader can see in the last of (30), we will use the same symbol $|\cdot|$ to designate the Euclidean norm on different sets. For example here, $|t|$ is the Euclidean \mathbb{R}^4 -norm on \mathbb{T} while $|\lambda|$ is the Euclidean \mathbb{R}^2 -norm on $\mathbb{C}(\mathbf{i}_k)$.

In the idempotent basis, any hyperbolic number can be written as $x_{\hat{1}}\mathbf{e}_1 + x_{\hat{2}}\mathbf{e}_2$, with $x_{\hat{1}}$ and $x_{\hat{2}}$ in \mathbb{R} . We define the set \mathbb{D}^+ of positive hyperbolic numbers as

$$\mathbb{D}^+ := \{x_{\hat{1}}\mathbf{e}_1 + x_{\hat{2}}\mathbf{e}_2 \mid x_{\hat{1}}, x_{\hat{2}} \geq 0\}. \quad (32)$$

Clearly, $w \cdot w^\dagger \in \mathbb{D}^+$ for any w in \mathbb{T} .

2.2 \mathbb{T} -Module, scalar product and linear operators

The set of bicomplex numbers is a commutative ring. Just like vector spaces are defined over fields, modules are defined over rings. A module M defined over the ring of bicomplex numbers is called a \mathbb{T} -module (Gervais Lavoie et al., 2010a; 2011; Rochon & Tremblay, 2006).

Let $\{|u_l| \mid l = 1 \dots n\}$ be a \mathbb{T} -basis (a set of elements of M that form a basis), then the \mathbb{T} -module M is given by the set

$$M = \left\{ \sum_{l=1}^n w_l |u_l| \mid w_l \in \mathbb{T} \right\}. \quad (33)$$

For $k = 1, 2$, we define V_k as the set of all elements of the form $\mathbf{e}_k|\psi\rangle$, with $|\psi\rangle \in M$. Succinctly, $V_1 := \mathbf{e}_1 M$ and $V_2 := \mathbf{e}_2 M$. In fact, V_k , $k = 1, 2$ are vector spaces over $\mathbb{C}(\mathbf{i}_1)$ and any element $|v_k\rangle \in V_k$ satisfies $|v_k\rangle = \mathbf{e}_k|v_k\rangle$.

For arbitrary \mathbb{T} -modules, vector spaces V_1 and V_2 bear no structural similarities. For more specific modules, however, they may share structure. It was shown in (Gervais Lavoie et al., 2011) that if M is a finite-dimensional free \mathbb{T} -module, then V_1 and V_2 have the same dimension. For any $|\psi\rangle \in M$, there exist a unique decomposition

$$|\psi\rangle = \mathbf{e}_1 P_1(|\psi\rangle) + \mathbf{e}_2 P_2(|\psi\rangle), \quad (34)$$

where $\mathbf{e}_k P_k(|\psi\rangle) \in V_k$, $k = 1, 2$. One can show that ket projectors and idempotent-basis projectors (denoted with the same symbol) satisfy the following, for $k = 1, 2$:

$$P_k(s|\psi\rangle + t|\phi\rangle) = P_k(s)P_k(|\psi\rangle) + P_k(t)P_k(|\phi\rangle), \quad s, t \in \mathbb{T}. \quad (35)$$

It will be useful to rewrite (34) as

$$|\psi\rangle = \mathbf{e}_1|\psi_{\hat{1}}\rangle + \mathbf{e}_2|\psi_{\hat{2}}\rangle, \quad (36)$$

where

$$|\psi_{\hat{1}}\rangle := P_1(|\psi\rangle) \quad \text{and} \quad |\psi_{\hat{2}}\rangle := P_2(|\psi\rangle). \quad (37)$$

The \mathbb{T} -module M can be viewed as a vector space M' over $\mathbb{C}(\mathbf{i}_1)$, and $M' = V_1 \oplus V_2$. From a set-theoretical point of view, M and M' are identical. In this sense we can say, perhaps improperly, that the **module** M can be decomposed into the direct sum of two vector spaces over $\mathbb{C}(\mathbf{i}_1)$, i.e. $M = V_1 \oplus V_2$.

2.2.1 Bicomplex scalar product

A *bicomplex scalar product* maps two arbitrary kets $|\psi\rangle$ and $|\phi\rangle$ into a bicomplex number $(|\psi\rangle, |\phi\rangle)$, so that the following always holds ($s \in \mathbb{T}$):

1. $(|\psi\rangle, |\phi\rangle + |\chi\rangle) = (|\psi\rangle, |\phi\rangle) + (|\psi\rangle, |\chi\rangle)$;
2. $(|\psi\rangle, s|\phi\rangle) = s(|\psi\rangle, |\phi\rangle)$;
3. $(|\psi\rangle, |\phi\rangle) = (|\phi\rangle, |\psi\rangle)^\dagger$;
4. $(|\psi\rangle, |\psi\rangle) = 0 \Leftrightarrow |\psi\rangle = 0$.

Property 3 implies that $(|\psi\rangle, |\psi\rangle) \in \mathbb{D}$, while properties 2 and 3 together imply that $(s|\psi\rangle, |\phi\rangle) = s^\dagger(|\psi\rangle, |\phi\rangle)$. However, in this work we will also require the bicomplex scalar product (\cdot, \cdot) to be *hyperbolic positive*, i.e.

$$(|\psi\rangle, |\psi\rangle) \in \mathbb{D}^+, \quad \forall |\psi\rangle \in M. \quad (38)$$

This is a necessary condition if we want to recover the standard quantum mechanics from the bicomplex one.

Noted that the following projection of a bicomplex scalar product:

$$(\cdot, \cdot)_{\hat{k}} := P_k((\cdot, \cdot)) : M \times M \longrightarrow \mathbb{C}(\mathbf{i}_1) \quad (39)$$

is a **standard scalar product** on V_k , for $k = 1, 2$. One easily shows (Gervais Lavoie et al., 2010a, (3.12)) that

$$\begin{aligned} (|\psi\rangle, |\phi\rangle) &= \mathbf{e}_1 P_1((|\psi_{\hat{1}}\rangle, |\phi_{\hat{1}}\rangle)) + \mathbf{e}_2 P_2((|\psi_{\hat{2}}\rangle, |\phi_{\hat{2}}\rangle)) \\ &= \mathbf{e}_1 (|\psi_{\hat{1}}\rangle, |\phi_{\hat{1}}\rangle)_{\hat{1}} + \mathbf{e}_2 (|\psi_{\hat{2}}\rangle, |\phi_{\hat{2}}\rangle)_{\hat{2}}. \end{aligned} \quad (40)$$

As the reader can see, the caret notation (\hat{k}) will be used systematically to distinguish idempotent projection of ket, scalar product as well as scalar. In fact, this notation is simply a convenient way to deal with the idempotent representation $P_k(\cdot)$ in a more compact form.

We point out that a bicomplex scalar product is **completely characterized** by the two standard scalar products $(\cdot, \cdot)_{\hat{k}}$ on V_k . In fact, if $(\cdot, \cdot)_{\hat{k}}$ is an arbitrary scalar product on V_k , for $k = 1, 2$, then (\cdot, \cdot) defined as in (40) is a bicomplex scalar product on M .

In this work, we will use the Dirac notation

$$(|\psi\rangle, |\phi\rangle) = \langle \psi | \phi \rangle = \mathbf{e}_1 \langle \psi_{\hat{1}} | \phi_{\hat{1}} \rangle_{\hat{1}} + \mathbf{e}_2 \langle \psi_{\hat{2}} | \phi_{\hat{2}} \rangle_{\hat{2}} \quad (41)$$

for the scalar product. The one-to-one correspondence between *bra* $\langle \cdot |$ and *ket* $|\cdot\rangle$ can be established from the bicomplex Riesz theorem (Gervais Lavoie et al., 2010a, Th. 3.7) that we will present in section 3.

2.2.2 Bicomplex linear operators

A *bicomplex linear operator* A is a mapping from M to M such that, for any $s, t \in \mathbb{T}$ and any $|\psi\rangle, |\phi\rangle \in M$

$$A(s|\psi\rangle + t|\phi\rangle) = sA|\psi\rangle + tA|\phi\rangle. \quad (42)$$

A bicomplex linear operator A can always be written as $A = \mathbf{e}_1 A_{\hat{1}} + \mathbf{e}_2 A_{\hat{2}}$ and then,

$$A|\psi\rangle = \mathbf{e}_1 A_{\hat{1}}|\psi_{\hat{1}}\rangle + \mathbf{e}_2 A_{\hat{2}}|\psi_{\hat{2}}\rangle \quad (43)$$

where

$$A_{\hat{k}}|\psi_{\hat{k}}\rangle := P_k(A)|\psi_{\hat{k}}\rangle = P_k(A|\psi\rangle), \quad \forall |\psi\rangle \in M, \quad k = 1, 2. \quad (44)$$

The bicomplex *adjoint* operator A^* of A is the operator defined so that for any $|\psi\rangle, |\phi\rangle \in M$

$$(|\psi\rangle, A|\phi\rangle) = (A^*|\psi\rangle, |\phi\rangle). \quad (45)$$

One can show that in finite-dimensional free \mathbb{T} -modules, the adjoint always exists, is linear and satisfies (Rochon & Tremblay, 2006, Sec. 8.1)

$$(A^*)^* = A, \quad (sA + tB)^* = s^\dagger A^* + t^\dagger B^* \quad \text{and} \quad (AB)^* = B^* A^*. \quad (46)$$

The reader can note that we will use the same symbol for the adjoint operator in M or in V_k ;

$$A^* = \mathbf{e}_1 A_{\hat{1}}^* + \mathbf{e}_2 A_{\hat{2}}^*. \quad (47)$$

We shall say that a ket $|\psi\rangle$ belongs to the null cone (\mathcal{NC}) if either $|\psi_{\hat{1}}\rangle = 0$ or $|\psi_{\hat{2}}\rangle = 0$, and that a linear operator A belongs to the null cone (\mathcal{NC}) if either $A_{\hat{1}} = 0$ or $A_{\hat{2}} = 0$.

A bicomplex *self-adjoint* operator is a linear operator H such that

$$(|\psi\rangle, H|\phi\rangle) = (H|\psi\rangle, |\phi\rangle) \quad (48)$$

for all $|\psi\rangle$ and $|\phi\rangle$ in M .

Let $A : M \rightarrow M$ be a bicomplex linear operator. If there exists $\lambda \in \mathbb{T}$ and a ket $|\psi\rangle \in M$ such that $|\psi\rangle \notin \mathcal{NC}$ and that

$$A|\psi\rangle = \lambda|\psi\rangle \quad (49)$$

holds, then λ is called a bicomplex *eigenvalue* of A and $|\psi\rangle$ is called an *eigenket* of A corresponding to the eigenvalue λ . It was shown in (Rochon & Tremblay, 2006, Th. 14) that the eigenvalues of a self-adjoint operator acting in a finite-dimensional free \mathbb{T} -module, associated with eigenkets not in the null cone, are hyperbolic numbers.

Moreover, the eigenket equation (49) is equivalent to the system of two eigenket equations given by

$$A_{\hat{k}}|\psi_{\hat{k}}\rangle = \lambda_{\hat{k}}|\psi_{\hat{k}}\rangle, \quad k = 1, 2, \quad (50)$$

where $\lambda = \mathbf{e}_1\lambda_{\hat{1}} + \mathbf{e}_2\lambda_{\hat{2}}$, $\lambda_{\hat{1}}, \lambda_{\hat{2}} \in \mathbb{C}(\mathbf{i}_1)$ and $|\psi\rangle = \mathbf{e}_1|\psi_{\hat{1}}\rangle + \mathbf{e}_2|\psi_{\hat{2}}\rangle$. We say that $|\psi\rangle$ is an *eigenket* of A rather than an eigenvector because element of M are modules instead of vectors. For a complete treatment of the Module Theory, see (Bourbaki, 2006).

The reader can remark that the element $|\psi_{\hat{k}}\rangle$ was noted by $|\psi\rangle_{\hat{k}}$ in (Gervais Lavoie et al., 2010a; 2011). However, the notation $|\psi_{\hat{k}}\rangle$ is more appropriated here with scalar product in the Dirac notation.

3. Infinite-dimensional bicomplex Hilbert spaces

The mathematical structure of standard quantum mechanics (SQM) consists in Hilbert spaces, frequently infinite-dimensional ones, defined over the field of complex numbers (Birkhoff & Von Neumann, 1936). In the case of bicomplex quantum mechanics (BQM), the natural extension is to deal with infinite-dimensional bicomplex Hilbert spaces. We will sketched some important results here but proof and additional material can be found in (Gervais Lavoie et al., 2010a).

Result 1. *Let M be a \mathbb{T} -module and let (\cdot, \cdot) be a bicomplex scalar product define on M . The space $\{M, (\cdot, \cdot)\}$ is called a \mathbb{T} -inner product space, or bicomplex pre-Hilbert space. When no confusion arise, we will noted $\{M, (\cdot, \cdot)\}$ as M .*

We defined a *bicomplex Hilbert space* as a \mathbb{T} -inner product space (bicomplex pre-Hilbert space) which is complete (with respect to the \mathbb{T} -norm induced by the bicomplex scalar product (\cdot, \cdot)).

Result 2. *Because $M = V_1 \oplus V_2$, and $(\cdot, \cdot) = (\cdot, \cdot)_{\hat{1}}\mathbf{e}_1 + (\cdot, \cdot)_{\hat{2}}\mathbf{e}_2$, we have that $\{M, (\cdot, \cdot)\}$ is a bicomplex Hilbert space if and only if $\{V_k, (\cdot, \cdot)_{\hat{k}}\}$ is complete, $k = 1, 2$.*

As a corollary of this result, if $\{M, (\cdot, \cdot)\}$ is a bicomplex Hilbert space, then $\{V_k, (\cdot, \cdot)_{\hat{k}}\}$ is a complex (in $\mathbb{C}(\mathbf{i}_1)$) Hilbert space for $k = 1, 2$.

A direct application of this corollary leads to the bicomplex Riesz representation theorem as follow.

Result 3 (Riesz). *Let $\{M, (\cdot, \cdot)\}$ be a bicomplex Hilbert space and let $f : M \rightarrow \mathbb{T}$ be a continuous linear functional on M . Then, there exist a unique $|\psi\rangle \in M$ such that $\forall |\phi\rangle \in M$, $f(|\phi\rangle) = (|\psi\rangle, |\phi\rangle) = \langle\psi|\phi\rangle$.*

The bicomplex Riesz theorem means that for an arbitrary bicomplex Hilbert space M , the dual space M^* of continuous linear functionals on M can be identified with M through the bicomplex scalar product (\cdot, \cdot) .

Let us take a look at the orthonormalization of elements of M . Let $\{|s_l\rangle\}$ be a countable basis of M . Then, $\{|s_l\rangle\}$ can always be orthonormalized.

It is interesting to note that the normalizability of kets requires that the scalar product belongs to \mathbb{D}^+ . To see this, let us write $(|m_1\rangle, |m_1\rangle) = a_{\hat{1}}\mathbf{e}_1 + a_{\hat{2}}\mathbf{e}_2$ with $a_{\hat{1}}, a_{\hat{2}} \in \mathbb{R}$, and let

$$|m'_1\rangle = (z_{\hat{1}}\mathbf{e}_1 + z_{\hat{2}}\mathbf{e}_2)|m_1\rangle,$$

with $z_{\hat{1}}, z_{\hat{2}} \in \mathbb{C}(\mathbf{i}_1)$ and $z_{\hat{1}} \neq 0 \neq z_{\hat{2}}$. We get

$$\begin{aligned} (|m'_1\rangle, |m'_1\rangle) &= (|z_{\hat{1}}|^2 \mathbf{e}_1 + |z_{\hat{2}}|^2 \mathbf{e}_2) (|m_1\rangle, |m_1\rangle) \\ &= (|z_{\hat{1}}|^2 \mathbf{e}_1 + |z_{\hat{2}}|^2 \mathbf{e}_2) (a_{\hat{1}} \mathbf{e}_1 + a_{\hat{2}} \mathbf{e}_2) \\ &= c_{\hat{1}} a_{\hat{1}} \mathbf{e}_1 + c_{\hat{2}} a_{\hat{2}} \mathbf{e}_2, \end{aligned} \quad (51)$$

with $c_{\hat{k}} = |z_{\hat{k}}|^2 \in \mathbb{R}^+$. The normalization condition of $|m'_1\rangle$ becomes

$$c_{\hat{1}} a_{\hat{1}} \mathbf{e}_1 + c_{\hat{2}} a_{\hat{2}} \mathbf{e}_2 = 1, \quad (52)$$

or $c_{\hat{1}} a_{\hat{1}} = 1 = c_{\hat{2}} a_{\hat{2}}$. This is possible only if $a_{\hat{1}} > 0$ and $a_{\hat{2}} > 0$. Hence, in particular $(|m_1\rangle, |m_1\rangle) \in \mathbb{D}^+$.

In fact, we will show here that the bicomplex normalization is a more restricting condition than the complex one. Let us try to normalized a ket $|m_2\rangle \in \mathcal{NC}$. Suppose that $|m_2\rangle = \mathbf{e}_1 |m_2\rangle$ (which means that the part in \mathbf{e}_2 is $|0\rangle$) and let us write $(|m_2\rangle, |m_2\rangle) = a_{\hat{1}} \mathbf{e}_1 + a_{\hat{2}} \mathbf{e}_2$ as previously. From the properties of the bicomplex scalar product 2.2.1, we can write

$$(|m_2\rangle, |m_2\rangle) = (|m_2\rangle, \mathbf{e}_1 |m_2\rangle) = \mathbf{e}_1 (|m_2\rangle, |m_2\rangle), \quad (53)$$

which directly imply that

$$a_{\hat{1}} \mathbf{e}_1 + a_{\hat{2}} \mathbf{e}_2 = \mathbf{e}_1 (a_{\hat{1}} \mathbf{e}_1 + a_{\hat{2}} \mathbf{e}_2) = a_{\hat{1}} \mathbf{e}_1. \quad (54)$$

In other words, $a_{\hat{2}} = 0$, but in this case, we cannot satisfy the condition (52) (\mathbf{e}_1 is not invertible) and then, $|m_2\rangle$ is not normalizable.

To state this another way, the requirement to be not in the \mathcal{NC} is embedded in the normalization requirement. In this sense, we can say that the bicomplex normalization is more restrictive than the complex one, because it exclude an infinite number of elements of M , those in the \mathcal{NC} instead of only one in the complex case, the vector $|0\rangle$. However, in practice, this is not a big glitch because we naturally avoid the \mathcal{NC} to avoid the "trivial" situation where $M \simeq \mathbf{e}_k V_k$.

4. Bicomplex quantum mechanics

Bicomplex quantum mechanics was first investigated in (Rochon & Tremblay, 2004; 2006). In (Rochon & Tremblay, 2004), the bicomplex Schrödinger equation was introduced and the continuity equations and symmetries was derived. The bicomplex Born probability formulas was studied by extracting some real moduli. In (Rochon & Tremblay, 2006), the concept of free modules over the ring of bicomplex numbers was developed, bicomplex scalar product, Dirac notation and linear operator was also investigated.

Motivated by these results, the problem of the bicomplex quantum harmonic oscillator was worked out in details in (Gervais Lavoie et al., 2010b), and the eigenvalues and eigenfunctions was obtained. The section 4.1 is a summary of important results on the bicomplex harmonic oscillator.

First of all, we will state a fundamental postulate on which the BQM stands.

Postulate 1. *There exist two operators X and P (called the bicomplex position and momentum operators respectively) in M such that X and P are self-adjoint and their commutation relation is a multiple of the identity.*

Mathematically, this postulate means that

$$[X, P] = wI, \quad w \in \mathbb{T}, \quad X, P, I \in M, \quad X^* = X \quad \text{and} \quad P^* = P. \quad (55)$$

Without loss of generality, we can rewrite w as $\mathbf{i}_1 \hbar \zeta$, $\zeta \in \mathbb{T}$. Let $|E\rangle \notin \mathcal{NC}$ be a normalizable element of M . The properties of the bicomplex scalar product 2.2.1 allow us to write

$$\begin{aligned} \mathbf{i}_1 \hbar \zeta (|E\rangle, |E\rangle) &= (|E\rangle, \mathbf{i}_1 \hbar \zeta I |E\rangle) \\ &= (|E\rangle, XP|E\rangle) - (|E\rangle, PX|E\rangle) \\ &= (X|E\rangle, P|E\rangle) - (P|E\rangle, X|E\rangle) \\ &= (PX|E\rangle, |E\rangle) - (XP|E\rangle, |E\rangle) \\ &= (-\mathbf{i}_1 \hbar \zeta I |E\rangle, |E\rangle) \\ &= \mathbf{i}_1 \hbar \zeta^\dagger (|E\rangle, |E\rangle). \end{aligned} \quad (56)$$

Because $|E\rangle$ is normalizable, $(|E\rangle, |E\rangle) \notin \mathcal{NC}$ and we have that $\zeta = \zeta^\dagger$ which signify that $\zeta \in \mathbb{D}$, or $\zeta = \zeta_1 \mathbf{e}_1 + \zeta_2 \mathbf{e}_2$ with $\zeta_1, \zeta_2 \in \mathbb{R}$.

As the reader can see, the assumptions made here on X , P , ζ and $|E\rangle$ are very general ones, and are closely related to the assumptions made in SQM. The main idea beyond all this is to build the BQM standing on as least assumptions as possible. For example, we could postulate that in BQM, $[X, P] = \mathbf{i}_1 \hbar I$ as in the standard case, without questioning itself. However, as we see later, if we had done that, we would have neglected an apparently nontrivial part of the solution.

4.1 The bicomplex quantum harmonic oscillator

We start this section with a little calculation that allow us to restrict further the constant ζ . This derivation is given in (Gervais Lavoie et al., 2010b), but we think that it is instructive to give it again here.

First of all, to work out the quantum harmonic oscillator problem, we need an Hamiltonian. We will consider the following

$$H = \frac{1}{2m} P^2 + \frac{1}{2} m \omega^2 X^2, \quad (57)$$

as the Hamiltonian of the bicomplex harmonic oscillator, where m and ω are positive real numbers and X and P are the bicomplex self-adjoint operators defined previously. Clearly, this imply $H : M \rightarrow M$ and that H is self-adjoint.

Secondly, we will ask the following: Is it possible to further restrict meaningful values of ζ , for instance by a simple rescaling of X and P ? To answer this question, let us write

$$X = (\alpha_1 \mathbf{e}_1 + \alpha_2 \mathbf{e}_2) X', \quad P = (\beta_1 \mathbf{e}_1 + \beta_2 \mathbf{e}_2) P', \quad (58)$$

with nonzero $\alpha_{\hat{k}}$ and $\beta_{\hat{k}}$ ($k = 1, 2$). For X' and P' to be self-adjoint, $\alpha_{\hat{k}}$ and $\beta_{\hat{k}}$ must be real. Making use of (57) we find that

$$\begin{aligned} H &= \frac{1}{2m}(\beta_1^2 \mathbf{e}_1 + \beta_2^2 \mathbf{e}_2)(P')^2 + \frac{1}{2}m\omega^2(\alpha_1^2 \mathbf{e}_1 + \alpha_2^2 \mathbf{e}_2)(X')^2 \\ &= \frac{1}{2m'}(P')^2 + \frac{1}{2}m'(\omega')^2(X')^2. \end{aligned} \quad (59)$$

For m' and ω' to be positive real numbers, $\alpha_1^2 \mathbf{e}_1 + \alpha_2^2 \mathbf{e}_2$ and $\beta_1^2 \mathbf{e}_1 + \beta_2^2 \mathbf{e}_2$ must also belong to \mathbb{R}^+ . This entails that $\alpha_1^2 = \alpha_2^2$ and $\beta_1^2 = \beta_2^2$, or equivalently $\alpha_1 = \pm\alpha_2$ and $\beta_1 = \pm\beta_2$. Hence we can write

$$\begin{aligned} \mathbf{i}_1 \hbar (\xi_1 \mathbf{e}_1 + \xi_2 \mathbf{e}_2) I &= [X, P] \\ &= [(\alpha_1 \mathbf{e}_1 + \alpha_2 \mathbf{e}_2) X', (\beta_1 \mathbf{e}_1 + \beta_2 \mathbf{e}_2) P'] \\ &= (\alpha_1 \beta_1 \mathbf{e}_1 + \alpha_2 \beta_2 \mathbf{e}_2) [X', P']. \end{aligned} \quad (60)$$

But this in turn implies that

$$[X', P'] = \mathbf{i}_1 \hbar \left(\frac{\xi_1}{\alpha_1 \beta_1} \mathbf{e}_1 + \frac{\xi_2}{\alpha_2 \beta_2} \mathbf{e}_2 \right) I = \mathbf{i}_1 \hbar (\zeta'_1 \mathbf{e}_1 + \zeta'_2 \mathbf{e}_2) I. \quad (61)$$

This equation shows that $\alpha_1, \alpha_2, \beta_1$ and β_2 can always be picked so that ζ'_1 and ζ'_2 are positive. Furthermore, we can choose α_1 and β_1 so as to make ζ'_1 equal to 1. But since $|\alpha_1 \beta_1| = |\alpha_2 \beta_2|$, we have no control over the norm of ζ'_2 . The upshot is that we can always write H as in (57), with the commutation relation of X and P given by

$$[X, P] = \mathbf{i}_1 \hbar \zeta I = \mathbf{i}_1 \hbar (\xi_1 \mathbf{e}_1 + \xi_2 \mathbf{e}_2) I \quad \text{with} \quad \xi_1, \xi_2 \in \mathbb{R}^+. \quad (62)$$

We also have the freedom of setting either $\xi_1 = 1$ or $\xi_2 = 1$, but not both. In all this work, we assumed that $\xi \notin \mathcal{NC}$ (which means $\xi_{\hat{k}} \neq 0, k = 1, 2$). Otherwise, BQM is reduced to SQM time a constant.

In (Gervais Lavoie et al., 2010b), we work out the bicomplex harmonic oscillator problem in the algebraic way in full details. Here, to present our results, we will give a sketch of the differential solution and show that it's lead to the same eigenfunctions.

First of all, we need to compute the action of the operators X and P in their functional form. To do this, let us assume that

$$X|x\rangle = x|x\rangle, \quad X : M \rightarrow M, \quad |x\rangle \in M \quad \text{and} \quad x \in \mathbb{R}. \quad (63)$$

This signify that $|x\rangle$ is an eigenket of X and that x is the real eigenvalue of X associate with the ket $|x\rangle$. Because $|x\rangle$ is an eigenket of the position operator, it is reasonable to write $\langle x|x'\rangle = \delta(x - x')$, with $\delta(x - x')$ the real Dirac delta function. Let us now consider the following

$$\langle x|[X, P]|x'\rangle = \langle x|\mathbf{i}_1 \hbar \zeta I|x'\rangle = \mathbf{i}_1 \hbar \zeta \delta(x - x'). \quad (64)$$

On the other hand,

$$\begin{aligned}
 \langle x|[X, P]|x' \rangle &= \langle x|XP|x' \rangle - \langle x|PX|x' \rangle \\
 &= \langle x'|PX|x \rangle^\dagger - x' \langle x|P|x' \rangle \\
 &= x^\dagger \langle x|P|x' \rangle - x' \langle x|P|x' \rangle \\
 &= (x^\dagger - x') \langle x|P|x' \rangle \\
 &= (x - x') \langle x|P|x' \rangle.
 \end{aligned} \tag{65}$$

Putting the two results together, we get

$$(x - x') \langle x|P|x' \rangle = \mathbf{i}_1 \hbar \tilde{\zeta} \delta(x - x'). \tag{66}$$

In SQM, we know that $(x - x') \frac{d}{dx} \delta(x - x') = -\delta(x - x')$ (Marchildon, 2002, chap. 5). But we can also use this result here because $x \in \mathbb{R}$. This lead to

$$\langle x|P|x' \rangle = -\mathbf{i}_1 \hbar \tilde{\zeta} \frac{d}{dx} \delta(x - x'). \tag{67}$$

At this point, it is easy to see that the functional form of the position and momentum bicomplex operators are given by

$$X \rightarrow x, \quad P \rightarrow -\mathbf{i}_1 \hbar \tilde{\zeta} \frac{d}{dx}. \tag{68}$$

With these representations, we can rewrite the Hamiltonian (57) as a differential equation. Let $\phi_n(x)$ be a normalisable eigenfunction of H (in the coordinate representation). Then, we have

$$\begin{aligned}
 \frac{1}{2m} P^2 \phi_n(x) + \frac{1}{2} m \omega^2 X^2 \phi_n(x) &= H \phi_n(x) \\
 \Rightarrow -\frac{\hbar^2 \tilde{\zeta}^2}{2m} \frac{d^2}{dx^2} \phi_n(x) + \frac{1}{2} m \omega^2 x^2 \phi_n(x) &= E_n \phi_n(x).
 \end{aligned} \tag{69}$$

A priori, this equation is a bicomplex equation of the real variable x . Taking $\tilde{\zeta} = \mathbf{e}_1 \tilde{\zeta}_1 + \mathbf{e}_2 \tilde{\zeta}_2$, $E_n = \mathbf{e}_1 E_{n\hat{1}} + \mathbf{e}_2 E_{n\hat{2}}$ and $\phi_n(x) = \mathbf{e}_1 \phi_{n\hat{1}}(x) + \mathbf{e}_2 \phi_{n\hat{2}}(x)$, we get

$$-\frac{\hbar^2 \tilde{\zeta}_k^2}{2m} \frac{d^2}{dx^2} \phi_{n\hat{k}}(x) + \frac{1}{2} m \omega^2 x^2 \phi_{n\hat{k}}(x) = E_{n\hat{k}} \phi_{n\hat{k}}(x) \quad \text{with} \quad k = 1, 2. \tag{70}$$

In this equation, $\tilde{\zeta}_k \in \mathbb{R}^+$ because of (62), $E_{n\hat{k}} \in \mathbb{R}$ because E_n is the eigenvalue of a self-adjoint operator, and $\phi_{n\hat{k}}(x)$ is a complex function of the real variable x . In fact, (70) is exactly the differential equation of the standard quantum harmonic oscillator with \hbar replaced by $\hbar \tilde{\zeta}_k$. This also mean that we already know the solutions for $\phi_{n\hat{k}}(x)$ and for $E_{n\hat{k}}$ they are given by (Marchildon, 2002, chap. 5)

$$\phi_{n\hat{k}}(x) = \left[\sqrt{\frac{m\omega}{\pi \hbar \tilde{\zeta}_k}} \frac{1}{2^n n!} \right]^{1/2} \exp \left\{ -\frac{m\omega}{2\hbar \tilde{\zeta}_k} x^2 \right\} H_n \left(\sqrt{\frac{m\omega}{\hbar \tilde{\zeta}_k}} x \right), \tag{71}$$

$$E_{n\hat{k}} = \hbar \tilde{\zeta}_k \omega \left(n + \frac{1}{2} \right), \tag{72}$$

with $H_n(x)$ the Hermite polynomial of order n in the real variable x . Let us define the variable $\theta_{\hat{k}}$ for convenience as

$$\theta_{\hat{k}} := \sqrt{\frac{m\omega}{\hbar\zeta_{\hat{k}}}} x \quad \text{for} \quad k = 1, 2. \quad (73)$$

It can be shown (Price, 1991) that for any bicomplex number $w = z_{\hat{1}}\mathbf{e}_1 + z_{\hat{2}}\mathbf{e}_2$,

$$e^w = \mathbf{e}_1 e^{z_{\hat{1}}} + \mathbf{e}_2 e^{z_{\hat{2}}}. \quad (74)$$

This holds also for any polynomial function $Q(w)$, that is,

$$Q(z_{\hat{1}}\mathbf{e}_1 + z_{\hat{2}}\mathbf{e}_2) = \mathbf{e}_1 Q(z_{\hat{1}}) + \mathbf{e}_2 Q(z_{\hat{2}}). \quad (75)$$

Moreover, if $\zeta = \zeta_{\hat{1}}\mathbf{e}_1 + \zeta_{\hat{2}}\mathbf{e}_2$ with $\zeta_{\hat{1}}$ and $\zeta_{\hat{2}}$ positive, we have

$$\frac{1}{\zeta^{1/4}} = \frac{\mathbf{e}_1}{\zeta_{\hat{1}}^{1/4}} + \frac{\mathbf{e}_2}{\zeta_{\hat{2}}^{1/4}}. \quad (76)$$

From (72), we have that the energy E_n of the bicomplex harmonic oscillator is given by

$$E_n = E_{n\hat{1}}\mathbf{e}_1 + E_{n\hat{2}}\mathbf{e}_2 = \mathbf{e}_1 \hbar \zeta_{\hat{1}} \omega \left(n + \frac{1}{2} \right) + \mathbf{e}_2 \hbar \zeta_{\hat{2}} \omega \left(n + \frac{1}{2} \right) = \hbar \omega \left(n + \frac{1}{2} \right) \zeta. \quad (77)$$

For the eigenfunctions, (71) imply that $\phi_n(x)$ will be given by

$$\begin{aligned} \phi_n(x) &= \phi_{n\hat{1}}(x)\mathbf{e}_1 + \phi_{n\hat{2}}(x)\mathbf{e}_2 \\ &= \mathbf{e}_1 \left[\sqrt{\frac{m\omega}{\pi\hbar\zeta_{\hat{1}}}} \frac{1}{2^n n!} \right]^{1/2} e^{-\theta_{\hat{1}}^2/2} H_n(\theta_{\hat{1}}) + \mathbf{e}_2 \left[\sqrt{\frac{m\omega}{\pi\hbar\zeta_{\hat{2}}}} \frac{1}{2^n n!} \right]^{1/2} e^{-\theta_{\hat{2}}^2/2} H_n(\theta_{\hat{2}}) \\ &= \left\{ \mathbf{e}_1 \left[\sqrt{\frac{m\omega}{\pi\hbar\zeta_{\hat{1}}}} \frac{1}{2^n n!} \right]^{1/2} + \mathbf{e}_2 \left[\sqrt{\frac{m\omega}{\pi\hbar\zeta_{\hat{2}}}} \frac{1}{2^n n!} \right]^{1/2} \right\} \\ &\quad \cdot \left\{ \mathbf{e}_1 e^{-\theta_{\hat{1}}^2/2} + \mathbf{e}_2 e^{-\theta_{\hat{2}}^2/2} \right\} \left\{ \mathbf{e}_1 H_n(\theta_{\hat{1}}) + \mathbf{e}_2 H_n(\theta_{\hat{2}}) \right\}. \end{aligned} \quad (78)$$

Moreover, with the help of (74) and (76), we obtain

$$\phi_n(x) = \left[\sqrt{\frac{m\omega}{\pi\hbar\zeta}} \frac{1}{2^n n!} \right]^{1/2} e^{-\theta^2/2} H_n(\theta), \quad (79)$$

where

$$H_n(\theta) := \mathbf{e}_1 H_n(\theta_{\hat{1}}) + \mathbf{e}_2 H_n(\theta_{\hat{2}}) \quad (80)$$

is a hyperbolic Hermite polynomial of order n .

Equation (79) expresses normalized eigenfunctions of the bicomplex harmonic oscillator Hamiltonian purely in terms of hyperbolic constants and functions, with no reference to a particular representation like $\{\mathbf{e}_k\}$. Indeed ζ can be viewed as a \mathbb{D}^+ constant, θ is equal to $\sqrt{m\omega/\hbar\zeta} x$ and $H_n(\theta)$ is just the Hermite polynomial in θ .

In (Gervais Lavoie et al., 2010a), we show that the set $\{\phi_n(x) \mid n = 0, 1, \dots\}$ form a \mathbb{T} -basis of M , and that M is a bicomplex Hilbert space with the following decomposition for an arbitrary $\psi(x) \in M$;

$$\psi(x) = \sum_n w_n \phi_n(x) \quad \text{with} \quad w_n \in \mathbb{T}. \quad (81)$$

Moreover, in (Gervais Lavoie et al., 2010b), we show that the most general eigenfunction of H is given by a linear combination, in the idempotent basis, of two functions $\phi_{n\hat{k}}(x)$ with some coefficient, and possibly different order n , such as

$$\phi(x) = \mathbf{e}_1 w_{l\hat{1}} \phi_{l\hat{1}}(x) + \mathbf{e}_2 w_{n\hat{2}} \phi_{n\hat{2}} \quad (82)$$

with $w_{l\hat{1}}$ and $w_{n\hat{2}}$ in $\mathbb{C}(\mathbf{i}_1)$ and $l, n = 0, 1, \dots$. The associated energy is then

$$E = \hbar\omega \left\{ \left(l + \frac{1}{2} \right) \mathbf{e}_1 \zeta_{\hat{1}} + \left(n + \frac{1}{2} \right) \mathbf{e}_2 \zeta_{\hat{2}} \right\}. \quad (83)$$

The eigenfunction (82) can be written explicitly as

$$\phi(x) = \left[\frac{m\omega}{\pi\hbar} \right]^{1/4} \left\{ \mathbf{e}_1 \frac{w_{l\hat{1}} e^{-\theta_{\hat{1}}^2/2}}{\sqrt{2^l l! \sqrt{\zeta_{\hat{1}}}}} H_l(\theta_{\hat{1}}) + \mathbf{e}_2 \frac{w_{n\hat{2}} e^{-\theta_{\hat{2}}^2/2}}{\sqrt{2^n n! \sqrt{\zeta_{\hat{2}}}}} H_n(\theta_{\hat{2}}) \right\}. \quad (84)$$

The function ϕ is normalized, *i.e.* $(\phi, \phi) = 1$, if

$$|w_{l\hat{1}}|^2 \mathbf{e}_1 + |w_{n\hat{2}}|^2 \mathbf{e}_2 = 1. \quad (85)$$

$\phi(x)$ can also be rewrite in term of $\mathbf{1}$ and \mathbf{j} . From (16), we only have to rewrite the idempotent basis in term of $\mathbf{1}$ and \mathbf{j} to find (we take ϕ normalized for simplicity)

$$\begin{aligned} \phi(x) = \frac{1}{2} \left[\frac{m\omega}{\pi\hbar} \right]^{1/4} & \left\{ \left(\frac{e^{-\theta_{\hat{1}}^2/2}}{\sqrt{2^l l! \sqrt{\zeta_{\hat{1}}}}} H_l(\theta_{\hat{1}}) + \frac{e^{-\theta_{\hat{2}}^2/2}}{\sqrt{2^n n! \sqrt{\zeta_{\hat{2}}}}} H_n(\theta_{\hat{2}}) \right) \right. \\ & \left. + \mathbf{j} \left(\frac{e^{-\theta_{\hat{1}}^2/2}}{\sqrt{2^l l! \sqrt{\zeta_{\hat{1}}}}} H_l(\theta_{\hat{1}}) - \frac{e^{-\theta_{\hat{2}}^2/2}}{\sqrt{2^n n! \sqrt{\zeta_{\hat{2}}}}} H_n(\theta_{\hat{2}}) \right) \right\}. \quad (86) \end{aligned}$$

This last equation however is a kind of hybrid between the representation $\{\mathbf{1}, \mathbf{j}\}$ and $\{\mathbf{e}_1, \mathbf{e}_2\}$. Indeed, $\theta_{\hat{k}}$ and $\zeta_{\hat{k}}$ are define in the idempotent basis. But, from (19), it is not hard to see that we can rewrite $\zeta_{\hat{k}}$ in term of new parameters α and β (that have nothing to do with those of (58)) as

$$\zeta_{\hat{1}} = \alpha + \beta, \quad \zeta_{\hat{2}} = \alpha - \beta \quad \text{such that} \quad \zeta = \alpha + \beta \mathbf{j}, \quad \alpha, \beta \in \mathbb{R}. \quad (87)$$

From this, we have that

$$\theta_{\hat{1}} = \sqrt{\frac{m\omega}{\hbar(\alpha + \beta)}} x \quad \text{and} \quad \theta_{\hat{2}} = \sqrt{\frac{m\omega}{\hbar(\alpha - \beta)}} x. \quad (88)$$

Using (87) and (88) in (86), we can rewrite $\phi(x)$ purely in term of 1 and \mathbf{j} , without any allusion to the idempotent basis. We find

$$\begin{aligned} \phi(x) = & \frac{1}{2} \left[\frac{m\omega}{\pi\hbar} \right]^{1/4} \\ & \cdot \left\{ \left(\frac{\exp \left\{ \frac{-m\omega}{2\hbar(\alpha+\beta)} x^2 \right\}}{\sqrt{2^l l! \sqrt{\alpha+\beta}}} H_l \left(\sqrt{\frac{m\omega}{\hbar(\alpha+\beta)}} x \right) + \frac{\exp \left\{ \frac{-m\omega}{2\hbar(\alpha-\beta)} x^2 \right\}}{\sqrt{2^n n! \sqrt{\alpha-\beta}}} H_n \left(\sqrt{\frac{m\omega}{\hbar(\alpha-\beta)}} x \right) \right) \right. \\ & \left. + \mathbf{j} \left(\frac{\exp \left\{ \frac{-m\omega}{2\hbar(\alpha+\beta)} x^2 \right\}}{\sqrt{2^l l! \sqrt{\alpha+\beta}}} H_l \left(\sqrt{\frac{m\omega}{\hbar(\alpha+\beta)}} x \right) - \frac{\exp \left\{ \frac{-m\omega}{2\hbar(\alpha-\beta)} x^2 \right\}}{\sqrt{2^n n! \sqrt{\alpha-\beta}}} H_n \left(\sqrt{\frac{m\omega}{\hbar(\alpha-\beta)}} x \right) \right) \right\}. \end{aligned} \quad (89)$$

One can remark that the conditions $\xi \in \mathbb{D}^+$ and $\xi \notin \mathcal{NC}$ are express as $\alpha + \beta > 0$ and $\alpha - \beta > 0$ for the parameters α and β .

Another way to express our eigenfunctions in term of real and hyperbolic part is to rewrite the hyperbolic exponential $e^{-\theta^2/2}$ in term of real hyperbolic sinus and cosinus. Indeed, from (Rochon & Tremblay, 2004), we can write

$$\begin{aligned} e^{-\theta^2/2} &= e^{-\frac{(\theta_1^2 + \theta_2^2)}{2}} e^{-\theta_1 \theta_2 \mathbf{j}} \\ &= e^{-\frac{(\theta_1^2 + \theta_2^2)}{2}} \{ \cosh \theta_1 \theta_2 - \mathbf{j} \sinh \theta_1 \theta_2 \} \quad \text{with} \quad \theta = \theta_1 + \theta_2 \mathbf{j}. \end{aligned} \quad (90)$$

Taking

$$\xi = \alpha + \beta \mathbf{j}, \quad (91)$$

we have that

$$\xi^{-1/4} = \frac{(\alpha + \beta)^{-1/4} + (\alpha - \beta)^{1/4}}{2} + \mathbf{j} \frac{(\alpha + \beta)^{-1/4} - (\alpha - \beta)^{1/4}}{2} = \alpha' + \beta' \mathbf{j}. \quad (92)$$

For the normalized eigenfunction (79), we can then write

$$\begin{aligned} \phi_n(x) &= \left[\sqrt{\frac{m\omega}{\pi\hbar}} \frac{1}{2^n n!} \right]^{1/2} e^{-\frac{(\theta_1^2 + \theta_2^2)}{2}} \\ & \cdot \left\{ \left[(\alpha' \cosh \theta_1 \theta_2 - \beta' \sinh \theta_1 \theta_2) \text{Re}(H_n(\theta)) + (\beta' \cosh \theta_1 \theta_2 - \alpha' \sinh \theta_1 \theta_2) \text{Hy}(H_n(\theta)) \right] \right. \\ & \left. \mathbf{j} \left[(\alpha' \cosh \theta_1 \theta_2 - \beta' \sinh \theta_1 \theta_2) \text{Hy}(H_n(\theta)) + (\beta' \cosh \theta_1 \theta_2 - \alpha' \sinh \theta_1 \theta_2) \text{Re}(H_n(\theta)) \right] \right\}, \end{aligned} \quad (93)$$

where $\text{Re}(H_n(\theta))$ and $\text{Hy}(H_n(\theta))$ stand for the real and the hyperbolic part of $H_n(\theta)$, respectively.

Finally, it is not so hard to see that if we take $\xi_{\hat{1}} = 1 = \xi_{\hat{2}}$ (resp. $\alpha = 1$ and $\beta = 0$) and $l = n$ (indirectly $X_{\hat{1}} = X_{\hat{2}}$, $P_{\hat{1}} = P_{\hat{2}}$ and so on), we recover the usual eigenfunctions and energy of the standard quantum harmonic oscillator.

We end this section with some plots of the eigenfunction $\phi(x)$ for different value of $\xi_{\hat{1}}$, $\xi_{\hat{2}}$, l and n . In Fig. 2 to 4, the dashed line stands for the real part, the dotted line for the hyperbolic

part and the full line is the probability density $|\phi(x)|^2 = |\phi_1(x)|^2/2 + |\phi_2(x)|^2/2$. We also take $m\omega/\hbar = 1$ on the y -axis for simplicity.

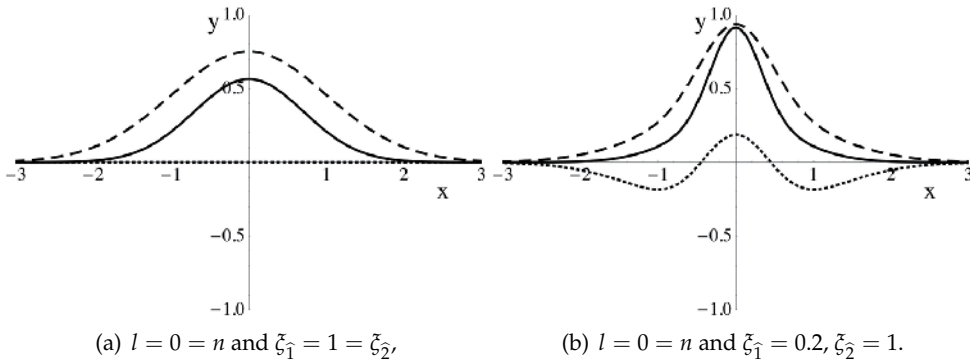

Fig. 2. Eigenfunction (86) with $l = 0 = n$. Fig. (a) show that eigenfunctions of the harmonic oscillator of the SQM can be recover from the bicomplex eigenfunction (86).

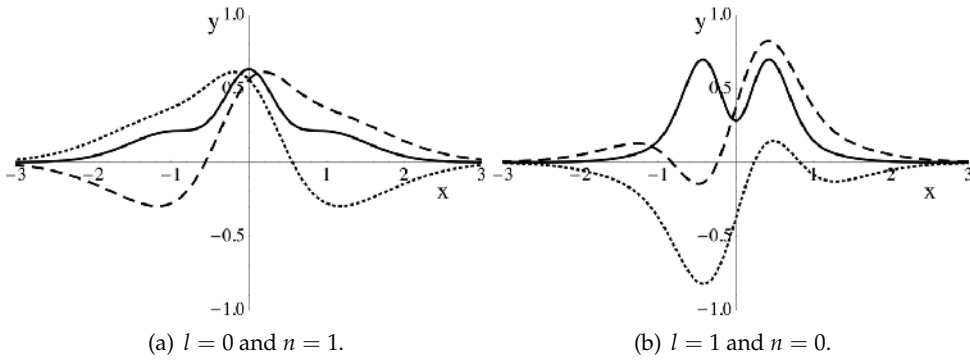

Fig. 3. Eigenfunction (86) with $\zeta_1 = 0.2, \zeta_2 = 1$.

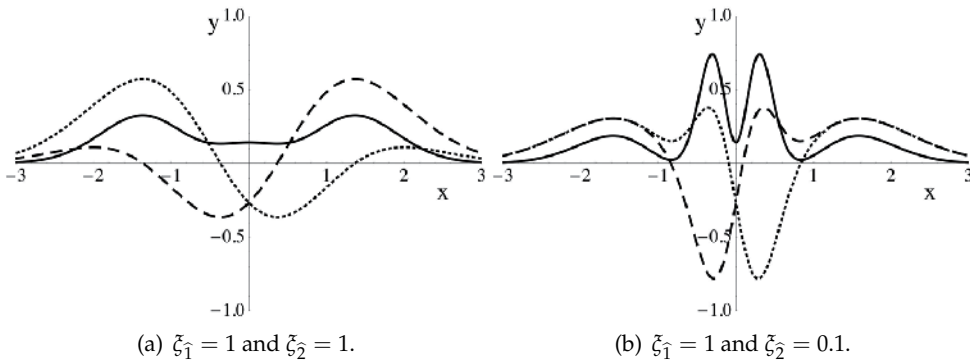

Fig. 4. Eigenfunction (86) with $l = 2, n = 1$.

5. The bicomplex Heisenberg uncertainty principle

The uncertainty principle, due to Heisenberg, is a fundamental principle in quantum mechanics, but also in post-classical physics in general. The uncertainty principle establish a lower limit on the theoretical precision that one can, even in principle, reach about two non-commuting observable of a physical system. This limit on the absolute precision that can be achieve is one of the biggest cut between the classical and deterministic physics, and the probabilistic post-classical quantum physics.

From the fundamental aspect of the uncertainty principle, it seems natural that all the extensions of standard quantum mechanics try to establish their own. For example, in quaternionic quantum mechanics, the uncertainty principle can be formulated as (Adler, 1995) $(\Delta A)^2 (\Delta B)^2 \geq \frac{1}{4} |\langle C \rangle|^2$, with $[A, B] = IC$, where A, B and C are self-adjoint (left-acting) operators and I is a left-acting anti-self-adjoint operator. Even if A, B, C and I are quaternionic operators, the quaternionic uncertainty principle have essentially the same form as the Heisenberg uncertainty principle in SQM.

In this section, we find, in an algebraic way, the bicomplex uncertainty principle of two non-commuting bicomplex self-adjoint operators. Let A' and B' be these two bicomplex self-adjoint operators. With none of the eigenkets of A' nor B' in the null-cone, we assumed that the eigenvalues of A' and B' are hyperbolic numbers.

We start with the same definition of the mean value of an operator as in SQM, that is a sum over the eigenvalues times the probability. However, we used the bicomplex Born formula (Rochon & Tremblay, 2004, Th. 1) $\mathcal{P}(\cdot) = |\psi|^2$, with $|\cdot|^2$ the Euclidean \mathbb{R}^4 -norm, to define the probability. Let $A' : M \rightarrow M$ be such that $A'|a'_i\rangle = a'_i|a'_i\rangle$, with $\{a'_i\}$ the set of hyperbolic eigenvalues and $\{|a'_i\rangle\}$ an orthonormalized \mathbb{T} -basis of eigenkets of A . We define

$$\langle A' \rangle_{BQM} = \sum_i a'_i \mathcal{P}(A' \rightarrow a'_i) = \sum_i a'_i |\langle a'_i | \psi \rangle|^2 \in \mathbb{D}. \quad (94)$$

The reader can remark that $\mathcal{P}(A' \rightarrow a'_i) = |\langle a'_i | \psi \rangle|^2$ is a real probability because it is restricted to $[0, 1]$ as long as $|\psi\rangle$ is normalized, and the sum of all probability is equal to 1. We know from (29) that $|\cdot|^2 = \frac{1}{2} |P_1(\cdot)|^2 + \frac{1}{2} |P_2(\cdot)|^2$. From the property of the bicomplex scalar product 2.2.1 (particularly (40)), we can write

$$\begin{aligned} \langle A' \rangle_{BQM} &= \sum_i a'_i \frac{|\langle a'_{i\hat{1}} | \psi_{\hat{1}} \rangle_{\hat{1}}|^2 + |\langle a'_{i\hat{2}} | \psi_{\hat{2}} \rangle_{\hat{2}}|^2}{2} \\ &= \frac{1}{2} \sum_i a'_i \left\{ \langle a'_{i\hat{1}} | \psi_{\hat{1}} \rangle_{\hat{1}} \overline{\langle a'_{i\hat{1}} | \psi_{\hat{1}} \rangle_{\hat{1}}} + \langle a'_{i\hat{2}} | \psi_{\hat{2}} \rangle_{\hat{2}} \overline{\langle a'_{i\hat{2}} | \psi_{\hat{2}} \rangle_{\hat{2}}} \right\} \\ &= \frac{1}{2} \sum_i \left(\mathbf{e}_1 a'_{i\hat{1}} + \mathbf{e}_2 a'_{i\hat{2}} \right) \left\{ \langle \psi_{\hat{1}} | a'_{i\hat{1}} \rangle_{\hat{1}} \langle a'_{i\hat{1}} | \psi_{\hat{1}} \rangle_{\hat{1}} + \langle \psi_{\hat{2}} | a'_{i\hat{2}} \rangle_{\hat{2}} \langle a'_{i\hat{2}} | \psi_{\hat{2}} \rangle_{\hat{2}} \right\} \\ &= \frac{1}{2} \left\{ \mathbf{e}_1 \sum_i a'_{i\hat{1}} P_1 \left(\langle \psi_{\hat{1}} | a'_{i\hat{1}} \rangle_{\hat{1}} \langle a'_{i\hat{1}} | \psi_{\hat{1}} \rangle_{\hat{1}} \right) + \mathbf{e}_2 \sum_i a'_{i\hat{2}} P_1 \left(\langle \psi_{\hat{1}} | a'_{i\hat{1}} \rangle_{\hat{1}} \langle a'_{i\hat{1}} | \psi_{\hat{1}} \rangle_{\hat{1}} \right) \right. \\ &\quad \left. + \mathbf{e}_1 \sum_i a'_{i\hat{1}} P_2 \left(\langle \psi_{\hat{2}} | a'_{i\hat{2}} \rangle_{\hat{2}} \langle a'_{i\hat{2}} | \psi_{\hat{2}} \rangle_{\hat{2}} \right) + \mathbf{e}_2 \sum_i a'_{i\hat{2}} P_2 \left(\langle \psi_{\hat{2}} | a'_{i\hat{2}} \rangle_{\hat{2}} \langle a'_{i\hat{2}} | \psi_{\hat{2}} \rangle_{\hat{2}} \right) \right\}. \quad (95) \end{aligned}$$

The $\overline{\cdot}$ stand for the standard complex conjugation because $\langle \cdot | \cdot \rangle_{\hat{k}} \in \mathbb{C}(\mathbf{i}_1)$. We want to warn the reader here that we can write $|\langle a'_{i\hat{k}} | \psi_{\hat{k}} \rangle_{\hat{k}}|^2 = \langle a'_{i\hat{k}} | \psi_{\hat{k}} \rangle_{\hat{k}} \overline{\langle a'_{i\hat{k}} | \psi_{\hat{k}} \rangle_{\hat{k}}}$ only because $\langle a'_{i\hat{k}} | \psi_{\hat{k}} \rangle_{\hat{k}} \in$

$\mathbb{C}(\mathbf{i}_1)$, in other word, $\langle \cdot | \cdot \rangle_{\hat{k}}$ is a **standard complex scalar product**. Otherwise, we cannot write $|\langle a'_i | \psi \rangle|^2 = \langle a'_i | \psi \rangle \overline{\langle a'_i | \psi \rangle}$ for $|a'_i\rangle, |\psi\rangle \in M$. Indeed, (29) imply that $|w|^2 = \text{Re}(w \cdot w^\dagger)$ instead of $|w|^2 = w \cdot w^\dagger$ for arbitrary $w \in \mathbb{T}$.

Using the properties of the projections operators, the fact that $a'_{i\hat{k}} \in \mathbb{R}$ and the standard spectral theorem on V_k , we can write

$$\begin{aligned} \sum_i a'_{i\hat{k}} P_k \left(\langle \psi_{\hat{k}} | a'_{i\hat{k}} \rangle \langle a'_{i\hat{k}} | \psi_{\hat{k}} \rangle \right) &= P_k \left(\langle \psi_{\hat{k}} | \left[\sum_i a'_{i\hat{k}} |a'_{i\hat{k}}\rangle \langle a'_{i\hat{k}}| \right] | \psi_{\hat{k}} \rangle \right) \\ &= P_k \left(\langle \psi_{\hat{k}} | A'_k | \psi_{\hat{k}} \rangle \right) = \langle \psi_{\hat{k}} | A'_k | \psi_{\hat{k}} \rangle_{\hat{k}}. \end{aligned} \quad (96)$$

Then, we obtain (keeping in mind that $\langle \psi | A' | \psi \rangle = \mathbf{e}_1 \langle \psi_{\hat{1}} | A'_1 | \psi_{\hat{1}} \rangle_{\hat{1}} + \mathbf{e}_2 \langle \psi_{\hat{2}} | A'_2 | \psi_{\hat{2}} \rangle_{\hat{2}}$)

$$\langle A' \rangle_{BQM} = \frac{1}{2} \left\{ \langle \psi | A' | \psi \rangle + \mathbf{e}_1 \sum_i a'_{i\hat{1}} \left| \langle a'_{i\hat{2}} | \psi_{\hat{2}} \rangle_{\hat{2}} \right|^2 + \mathbf{e}_2 \sum_i a'_{i\hat{2}} \left| \langle a'_{i\hat{1}} | \psi_{\hat{1}} \rangle_{\hat{1}} \right|^2 \right\}. \quad (97)$$

Noted that the last two terms of (97) represent a bicomplex (hyperbolic in fact) interaction or coupling between V_1 and V_2 . Indeed, if we want to restrict $BQM \rightarrow SQM$, we only have to take $a'_{i\hat{1}} = a'_{i\hat{2}}$ and $|a'_{i\hat{1}}\rangle = |a'_{i\hat{2}}\rangle$, and if we do that in (97), it is not hard to see that we recover the standard equation $\langle A \rangle_{SQM} = \langle \psi | A | \psi \rangle$.

For the term $\langle A'^2 \rangle_{BQM}$, the same steps will give us

$$\langle A'^2 \rangle_{BQM} = \frac{1}{2} \left\{ \langle \psi | A'^2 | \psi \rangle + \mathbf{e}_1 \sum_i a'^2_{i\hat{1}} \left| \langle a'_{i\hat{2}} | \psi_{\hat{2}} \rangle_{\hat{2}} \right|^2 + \mathbf{e}_2 \sum_i a'^2_{i\hat{2}} \left| \langle a'_{i\hat{1}} | \psi_{\hat{1}} \rangle_{\hat{1}} \right|^2 \right\}. \quad (98)$$

Let us now evaluate the product $\langle A'^2 \rangle \langle B'^2 \rangle$, with B' the bicomplex self-adjoint operator defined previously ($\{b'_i\}$ and $\{b'_i\}$ are defined the same way as for A'). For convenience, we will remove the BQM index

$$\begin{aligned} \langle A'^2 \rangle \langle B'^2 \rangle &= \frac{1}{4} \left\{ \langle \psi | A'^2 | \psi \rangle \langle \psi | B'^2 | \psi \rangle + \mathbf{e}_1 \langle \psi_{\hat{1}} | A'^2_1 | \psi_{\hat{1}} \rangle_{\hat{1}} \sum_i b'^2_{i\hat{1}} \left| \langle b'_{i\hat{2}} | \psi_{\hat{2}} \rangle_{\hat{2}} \right|^2 \right. \\ &\quad + \mathbf{e}_2 \langle \psi_{\hat{2}} | A'^2_2 | \psi_{\hat{2}} \rangle_{\hat{2}} \sum_i b'^2_{i\hat{2}} \left| \langle b'_{i\hat{1}} | \psi_{\hat{1}} \rangle_{\hat{1}} \right|^2 \\ &\quad + \mathbf{e}_1 \langle \psi_{\hat{1}} | B'^2_1 | \psi_{\hat{1}} \rangle_{\hat{1}} \sum_i a'^2_{i\hat{1}} \left| \langle a'_{i\hat{2}} | \psi_{\hat{2}} \rangle_{\hat{2}} \right|^2 \\ &\quad + \mathbf{e}_2 \langle \psi_{\hat{2}} | B'^2_2 | \psi_{\hat{2}} \rangle_{\hat{2}} \sum_i a'^2_{i\hat{2}} \left| \langle a'_{i\hat{1}} | \psi_{\hat{1}} \rangle_{\hat{1}} \right|^2 \\ &\quad + \mathbf{e}_2 \sum_{i,j} a'^2_{i\hat{2}} \left| \langle a'_{i\hat{1}} | \psi_{\hat{1}} \rangle_{\hat{1}} \right|^2 b'^2_{j\hat{2}} \left| \langle b'_{j\hat{1}} | \psi_{\hat{1}} \rangle_{\hat{1}} \right|^2 \\ &\quad \left. + \mathbf{e}_1 \sum_{i,j} a'^2_{i\hat{1}} \left| \langle a'_{i\hat{2}} | \psi_{\hat{2}} \rangle_{\hat{2}} \right|^2 b'^2_{j\hat{1}} \left| \langle b'_{j\hat{2}} | \psi_{\hat{2}} \rangle_{\hat{2}} \right|^2 \right\}. \end{aligned} \quad (99)$$

We would like to apply the bicomplex Schwartz inequality (Gervais Lavoie et al., 2010a, Th. 3.8) directly to the first term on the right hand side of (99). However, it is not so clear how we

can do that. The reason is that in bicomplex quantum mechanics, the (real) “length” of the ket $|\psi\rangle$ is not given by $\langle\psi|\psi\rangle$, but by $|\langle\psi|\psi\rangle|$. In consequence, the bicomplex Schwartz inequality apply to $|\langle\psi|\psi\rangle||\langle\phi|\phi\rangle|$ rather than $\langle\psi|\psi\rangle\langle\phi|\phi\rangle$. From the properties of the Euclidean norm on bicomplex, it doesn't seem possible, at first look, to inject a norm in (99) to build the term $|\langle\psi|A'^2|\psi\rangle||\langle\phi|B'^2|\phi\rangle|$.

One way to avoid this difficulty is to work with idempotent projection. We will noted $\langle\cdot\rangle_{\hat{k}}$ the projection $P_{\hat{k}}(\langle\cdot\rangle)$. From (99), we find

$$\begin{aligned} \langle A'^2\rangle_{\hat{1}}\langle B'^2\rangle_{\hat{1}} &= \frac{1}{4} \left\{ \langle\psi_{\hat{1}}|A'_{\hat{1}}{}^2|\psi_{\hat{1}}\rangle_{\hat{1}}\langle\psi_{\hat{1}}|B'_{\hat{1}}{}^2|\psi_{\hat{1}}\rangle_{\hat{1}} \right. \\ &\quad + \langle\psi_{\hat{1}}|A'_{\hat{1}}{}^2|\psi_{\hat{1}}\rangle_{\hat{1}} \sum_i b'_{i\hat{1}}{}^2 \left| \langle b'_{i\hat{2}}|\psi_{\hat{2}}\rangle_{\hat{2}} \right|^2 \\ &\quad + \langle\psi_{\hat{1}}|B'_{\hat{1}}{}^2|\psi_{\hat{1}}\rangle_{\hat{1}} \sum_i a'_{i\hat{1}}{}^2 \left| \langle a'_{i\hat{2}}|\psi_{\hat{2}}\rangle_{\hat{2}} \right|^2 \\ &\quad \left. + \sum_{i,j} a'_{i\hat{1}}{}^2 \left| \langle a'_{i\hat{2}}|\psi_{\hat{2}}\rangle_{\hat{2}} \right|^2 b'_{j\hat{1}}{}^2 \left| \langle b'_{j\hat{2}}|\psi_{\hat{2}}\rangle_{\hat{2}} \right|^2 \right\}, \end{aligned} \quad (100)$$

and equivalently for $\langle A'^2\rangle_{\hat{2}}\langle B'^2\rangle_{\hat{2}}$.

From the definition of the bicomplex scalar product 2.2.1, we know that $\langle\psi_{\hat{k}}|\psi_{\hat{k}}\rangle_{\hat{k}}$ is a **standard complex (in $\mathbb{C}(\mathbf{i}_1)$) scalar product**. This imply that $\langle\psi_{\hat{k}}|\psi_{\hat{k}}\rangle_{\hat{k}}$ is the (real) “length” of the ket $|\psi_{\hat{k}}\rangle$. From this, it becomes clear that we can apply the standard complex Schwartz inequality to the first term of (100), where the two kets are $A'_{\hat{1}}|\psi_{\hat{1}}\rangle$, $B'_{\hat{1}}|\psi_{\hat{1}}\rangle$ respectively. This leads to

$$\begin{aligned} \langle A'^2\rangle_{\hat{1}}\langle B'^2\rangle_{\hat{1}} &\geq \frac{1}{4} \left\{ \left| \langle\psi_{\hat{1}}|A'_{\hat{1}}B'_{\hat{1}}|\psi_{\hat{1}}\rangle_{\hat{1}} \right|^2 + \langle\psi_{\hat{1}}|A'_{\hat{1}}{}^2|\psi_{\hat{1}}\rangle_{\hat{1}} \sum_i b'_{i\hat{1}}{}^2 \left| \langle b'_{i\hat{2}}|\psi_{\hat{2}}\rangle_{\hat{2}} \right|^2 \right. \\ &\quad + \langle\psi_{\hat{1}}|B'_{\hat{1}}{}^2|\psi_{\hat{1}}\rangle_{\hat{1}} \sum_i a'_{i\hat{1}}{}^2 \left| \langle a'_{i\hat{2}}|\psi_{\hat{2}}\rangle_{\hat{2}} \right|^2 \\ &\quad \left. + \sum_{i,j} a'_{i\hat{1}}{}^2 \left| \langle a'_{i\hat{2}}|\psi_{\hat{2}}\rangle_{\hat{2}} \right|^2 b'_{j\hat{1}}{}^2 \left| \langle b'_{j\hat{2}}|\psi_{\hat{2}}\rangle_{\hat{2}} \right|^2 \right\}. \end{aligned} \quad (101)$$

It is important to remark that the \geq sign is well used here because (101) is an equation over reals numbers. Indeed, on the left hand side, as long as A' and B' are bicomplex self-adjoint operators, their eigenvalues are hyperbolic numbers, and then, according to (94), the mean valued of the operators A' and B' (equivalently for A'^2 and B'^2) are hyperbolic numbers. This also means that the projections $\langle\cdot\rangle_{\hat{k}}$ are real numbers.

On the right hand side of (101), $|\cdot|^2$ is the Euclidean \mathbb{R}^2 -norm and is undoubtedly real. As we said previously, $\langle\cdot|\cdot\rangle_{\hat{k}}$ is a standard complex scalar product. Then $\langle\psi_{\hat{1}}|A'_{\hat{1}}{}^2|\psi_{\hat{1}}\rangle_{\hat{1}}$ is real. Finally, the idempotent projection of hyperbolic numbers, the eigenvalues of A' and B' , are also real numbers.

Let us introduce four new operators

$$M'_k := \frac{1}{2} \left[A'_k, B'_k \right], \quad N'_k := \frac{1}{2} \left(A'_k B'_k + B'_k A'_k \right) \quad \text{for} \quad k = 1, 2. \quad (102)$$

It is easy to see that $M_{\hat{k}}'^* = -M_{\hat{k}}'$ and $N_{\hat{k}}'^* = N_{\hat{k}}'$. Let us write ($k = 1, 2$)

$$\begin{aligned}
\left| \langle \psi_{\hat{k}} | A_{\hat{k}}' B_{\hat{k}}' | \psi_{\hat{k}} \rangle_{\hat{k}} \right|^2 &= \left| P_k \left(\langle \psi_{\hat{k}} | M_{\hat{k}}' + N_{\hat{k}}' | \psi_{\hat{k}} \rangle \right) \right|^2 \\
&= \left| \langle \psi_{\hat{k}} | M_{\hat{k}}' | \psi_{\hat{k}} \rangle_{\hat{k}} + \langle \psi_{\hat{k}} | N_{\hat{k}}' | \psi_{\hat{k}} \rangle_{\hat{k}} \right|^2 \\
&= \left| \langle \psi_{\hat{k}} | M_{\hat{k}}' | \psi_{\hat{k}} \rangle_{\hat{k}} \right|^2 + \langle \psi_{\hat{k}} | M_{\hat{k}}' | \psi_{\hat{k}} \rangle_{\hat{k}} \overline{\langle \psi_{\hat{k}} | N_{\hat{k}}' | \psi_{\hat{k}} \rangle_{\hat{k}}} \\
&\quad + \left| \langle \psi_{\hat{k}} | N_{\hat{k}}' | \psi_{\hat{k}} \rangle_{\hat{k}} \right|^2 + \overline{\langle \psi_{\hat{k}} | M_{\hat{k}}' | \psi_{\hat{k}} \rangle_{\hat{k}}} \langle \psi_{\hat{k}} | N_{\hat{k}}' | \psi_{\hat{k}} \rangle_{\hat{k}} \\
&= \left| \langle \psi_{\hat{k}} | M_{\hat{k}}' | \psi_{\hat{k}} \rangle_{\hat{k}} \right|^2 + \langle \psi_{\hat{k}} | M_{\hat{k}}' | \psi_{\hat{k}} \rangle_{\hat{k}} \langle \psi_{\hat{k}} | N_{\hat{k}}' | \psi_{\hat{k}} \rangle_{\hat{k}} \\
&\quad + \left| \langle \psi_{\hat{k}} | N_{\hat{k}}' | \psi_{\hat{k}} \rangle_{\hat{k}} \right|^2 - \langle \psi_{\hat{k}} | M_{\hat{k}}' | \psi_{\hat{k}} \rangle_{\hat{k}} \langle \psi_{\hat{k}} | N_{\hat{k}}' | \psi_{\hat{k}} \rangle_{\hat{k}} \\
&= \left| \langle \psi_{\hat{k}} | M_{\hat{k}}' | \psi_{\hat{k}} \rangle_{\hat{k}} \right|^2 + \left| \langle \psi_{\hat{k}} | N_{\hat{k}}' | \psi_{\hat{k}} \rangle_{\hat{k}} \right|^2. \tag{103}
\end{aligned}$$

Here again, in the third line, we can use the property $|x|^2 = x \cdot \bar{x}$ only because $\langle \psi_{\hat{k}} | M_{\hat{k}}' | \psi_{\hat{k}} \rangle_{\hat{k}}$ and $\langle \psi_{\hat{k}} | N_{\hat{k}}' | \psi_{\hat{k}} \rangle_{\hat{k}}$ are element of $\mathbb{C}(\mathbf{i}_1)$. The argument is the same as for (95).

Now, using (103) in (101), we have

$$\begin{aligned}
\langle A'^2 \rangle_{\hat{1}} \langle B'^2 \rangle_{\hat{1}} &\geq \frac{1}{4} \left\{ \left| \langle \psi_{\hat{1}} | M_{\hat{1}}' | \psi_{\hat{1}} \rangle_{\hat{1}} \right|^2 + \left| \langle \psi_{\hat{1}} | N_{\hat{1}}' | \psi_{\hat{1}} \rangle_{\hat{1}} \right|^2 \right. \\
&\quad + \langle \psi_{\hat{1}} | A_{\hat{1}}'^2 | \psi_{\hat{1}} \rangle_{\hat{1}} \sum_i b_{i\hat{1}}'^2 \left| \langle b'_{i\hat{2}} | \psi_{\hat{2}} \rangle_{\hat{2}} \right|^2 \\
&\quad + \langle \psi_{\hat{1}} | B_{\hat{1}}'^2 | \psi_{\hat{1}} \rangle_{\hat{1}} \sum_i a_{i\hat{1}}'^2 \left| \langle a'_{i\hat{2}} | \psi_{\hat{2}} \rangle_{\hat{2}} \right|^2 \\
&\quad \left. + \sum_{i,j} a_{i\hat{1}}'^2 \left| \langle a'_{i\hat{2}} | \psi_{\hat{2}} \rangle_{\hat{2}} \right|^2 b_{j\hat{1}}'^2 \left| \langle b'_{j\hat{2}} | \psi_{\hat{2}} \rangle_{\hat{2}} \right|^2 \right\}. \tag{104}
\end{aligned}$$

Because (104) is an inequality, we can remove strictly positives terms form the right-hand side, exactly as we do in SQM (Marchildon, 2002, chap. 6). It is not hard to see that in fact, all the right-hand side term's are strictly positive. Then, by choice, we can write

$$\langle A'^2 \rangle_{\hat{1}} \langle B'^2 \rangle_{\hat{1}} \geq \frac{1}{4} \left| \langle \psi_{\hat{1}} | M_{\hat{1}}' | \psi_{\hat{1}} \rangle_{\hat{1}} \right|^2. \tag{105}$$

Let us now redefined the self-adjoint operator A' . We take $A_{\hat{k}}' := A_{\hat{k}} - \langle A \rangle_{\hat{k}} I$, with $A_{\hat{k}}$ self-adjoint and I the identity on $V_{\hat{k}}$ or M depending on context. Explicitly, for $A_{\hat{1}}'$, we have

$$A_{\hat{1}}' = A_{\hat{1}} - \frac{1}{2} \left\{ \langle \psi_{\hat{1}} | A_{\hat{1}} | \psi_{\hat{1}} \rangle_{\hat{1}} + \sum_i a_{i\hat{1}} \left| \langle a_{i\hat{2}} | \psi_{\hat{2}} \rangle_{\hat{2}} \right|^2 \right\} I. \tag{106}$$

As we said previously, and from the definition of the means value of an operator (94), we know that $\langle A \rangle_{\hat{k}} \in \mathbb{R}$ and $\langle A^2 \rangle_{\hat{k}} \in \mathbb{R}$. Because we modify the operator A' by only a constant operator ($\langle A \rangle_{\hat{k}} I$), it seems clear that the eigenkets of A' will be the same as the eigenkets of

A (this simply correspond to a rescaling of the operator), and we write $|a'_i\rangle = |a_i\rangle$. Moreover ($k = 1, 2$),

$$A'_k |a_{ik}\rangle = (A_{\hat{k}} - \langle A \rangle_{\hat{k}} I) |a_{ik}\rangle = (a_{ik} - \langle A \rangle_{\hat{k}}) |a_{ik}\rangle = a'_{ik} |a_{ik}\rangle. \quad (107)$$

Then, the eigenvalues of A'_k will be transform as $a'_{ik} = a_{ik} - \langle A \rangle_{\hat{k}} \in \mathbb{R}$. For A' , we have

$$A' = \mathbf{e}_1 (A_{\hat{1}} - \langle A \rangle_{\hat{1}} I) + \mathbf{e}_2 (A_{\hat{2}} - \langle A \rangle_{\hat{2}} I) = A - \langle A \rangle I. \quad (108)$$

Let us rewrite (98) in term of A and $\langle A \rangle$;

$$\begin{aligned} \langle A'^2 \rangle &= \frac{1}{2} \left\{ \langle \psi | (A - \langle A \rangle I)^2 | \psi \rangle + \mathbf{e}_1 \sum_i (a_{i\hat{1}} - \langle A \rangle_{\hat{1}})^2 |\langle a_{i\hat{2}} | \psi_{\hat{2}} \rangle_{\hat{2}}|^2 \right. \\ &\quad \left. + \mathbf{e}_2 \sum_i (a_{i\hat{2}} - \langle A \rangle_{\hat{2}})^2 |\langle a_{i\hat{1}} | \psi_{\hat{1}} \rangle_{\hat{1}}|^2 \right\}. \end{aligned} \quad (109)$$

Using the normalization of the kets $\{|\psi\rangle\}$ and $\{|a_{ik}\rangle\}$ (in fact, the orthonormalization can be assumed from (Gervais Lavoie et al., 2011, Sec. 4.3) and (Gervais Lavoie et al., 2010a, Sec. 3.2)) and the fact that $\sum_i |\langle a_{ik} | \psi_{\hat{k}} \rangle_{\hat{k}}|^2 = 1$, we can write

$$\begin{aligned} \langle A'^2 \rangle &= \frac{1}{2} \left\{ \langle \psi | A^2 | \psi \rangle + \langle A \rangle^2 - 2 \langle A \rangle \langle \psi | A | \psi \rangle \right. \\ &\quad + \mathbf{e}_1 \sum_i a_{i\hat{1}}^2 |\langle a_{i\hat{2}} | \psi_{\hat{2}} \rangle_{\hat{2}}|^2 + \mathbf{e}_1 \langle A \rangle_{\hat{1}}^2 - 2 \mathbf{e}_1 \langle A \rangle_{\hat{1}} \sum_i a_{i\hat{1}} |\langle a_{i\hat{2}} | \psi_{\hat{2}} \rangle_{\hat{2}}|^2 \\ &\quad \left. + \mathbf{e}_2 \sum_i a_{i\hat{2}}^2 |\langle a_{i\hat{1}} | \psi_{\hat{1}} \rangle_{\hat{1}}|^2 + \mathbf{e}_2 \langle A \rangle_{\hat{2}}^2 - 2 \mathbf{e}_2 \langle A \rangle_{\hat{2}} \sum_i a_{i\hat{2}} |\langle a_{i\hat{1}} | \psi_{\hat{1}} \rangle_{\hat{1}}|^2 \right\}. \end{aligned} \quad (110)$$

With the help of (97) and (98), we find

$$\langle A'^2 \rangle = \langle A^2 \rangle - \langle A \rangle^2 = (\Delta A)^2, \quad (111)$$

and clearly, $\langle A'^2 \rangle_{\hat{k}} = (\Delta A)_{\hat{k}}^2$.

By doing the same with the operator B' , that is $B'_k := B_{\hat{k}} - \langle B \rangle_{\hat{k}} I$, we find the same equation as for A . Moreover, it is not hard to verify that those definitions leads to $M'_k = M_k$. From this, (105) becomes

$$(\Delta A)_{\hat{1}}^2 (\Delta B)_{\hat{1}}^2 \geq \frac{1}{4} |\langle \psi_{\hat{1}} | M_{\hat{1}} | \psi_{\hat{1}} \rangle_{\hat{1}}|^2. \quad (112)$$

Because (99) is symmetrical in \mathbf{e}_k , the term $(\Delta A)_{\hat{2}}^2 (\Delta B)_{\hat{2}}^2$ will be identical at $(\Delta A)_{\hat{1}}^2 (\Delta B)_{\hat{1}}^2$ but with all the index 1 replaced by 2.

It is tempting to simply build the term $(\Delta A) (\Delta B)$ from (112) and say that this is the bicomplex uncertainty principle. However, we must recall that an inequality can only stand on real number and the term $(\Delta A) (\Delta B)$ is hyperbolic. The simplest way, maybe not the only,

to express our result in term of a simple bicomplex equation is to consider the norm of $(\Delta A) (\Delta B)$. Then, from (29), we have

$$\begin{aligned}
 |(\Delta A) (\Delta B)| &= \frac{1}{\sqrt{2}} \sqrt{|(\Delta A)_{\hat{1}} (\Delta B)_{\hat{1}}|^2 + |(\Delta A)_{\hat{2}} (\Delta B)_{\hat{2}}|^2} \\
 &\geq \frac{1}{\sqrt{2}} \sqrt{\left| \frac{1}{2} |\langle \psi_{\hat{1}} | M_{\hat{1}} | \psi_{\hat{1}} \rangle_{\hat{1}}|^2 + \left| \frac{1}{2} |\langle \psi_{\hat{2}} | M_{\hat{2}} | \psi_{\hat{2}} \rangle_{\hat{2}}|^2 \right|^2} \right.} \\
 &= \frac{1}{\sqrt{2}} \sqrt{\frac{1}{4} |\langle \psi_{\hat{1}} | M_{\hat{1}} | \psi_{\hat{1}} \rangle_{\hat{1}}|^2 + \frac{1}{4} |\langle \psi_{\hat{2}} | M_{\hat{2}} | \psi_{\hat{2}} \rangle_{\hat{2}}|^2} \\
 &= \frac{1}{2} |\langle \psi | M | \psi \rangle|, \tag{113}
 \end{aligned}$$

or, finally

$$|(\Delta A) (\Delta B)| \geq \frac{1}{4} |\langle \psi | [A, B] | \psi \rangle|. \tag{114}$$

This equation is the general bicomplex uncertainty principle of two non-commuting linear self-adjoint operator.

It can be remarked that (114) has the same form as the standard uncertainty principle, except that the $1/2$ factor replaced by $1/4$ here, and that it apply on $|(\Delta A) (\Delta B)|$ instead of $(\Delta A) (\Delta B)$. We would like to warn the reader that, according to (97), the right hand side of (114) **cannot** be written in the usual shorter form $\frac{1}{4} |\langle [A, B] \rangle|$.

5.1 Application: Position-momentum operators

We would now apply eq. (114) to the case of the position and momentum self-adjoint bicomplex linear operator X and P .

In section 4, we have seen that the commutator of X and P is given by

$$[X, P] = \mathbf{i}_1 \hbar (\zeta_{\hat{1}} \mathbf{e}_1 + \zeta_{\hat{2}} \mathbf{e}_2) I, \tag{115}$$

with $\zeta_{\hat{1}}, \zeta_{\hat{2}} \in \mathbb{R}^+$. From this, we find that

$$|(\Delta X) (\Delta P)| \geq \frac{|\langle \psi | \mathbf{i}_1 \hbar (\zeta_{\hat{1}} \mathbf{e}_1 + \zeta_{\hat{2}} \mathbf{e}_2) I | \psi \rangle|}{4} = \frac{\hbar |\mathbf{e}_1 \zeta_{\hat{1}} + \mathbf{e}_2 \zeta_{\hat{2}}|}{4} = \frac{\hbar \sqrt{\zeta_{\hat{1}}^2 + \zeta_{\hat{2}}^2}}{4\sqrt{2}} = \frac{\hbar |\zeta|}{4}. \tag{116}$$

As the eigenfunctions of the harmonic oscillator, the bicomplex uncertainty principle is completely determined by the two parameters $\zeta_{\hat{1}}$ and $\zeta_{\hat{2}}$ of our model. As we do in section 4.1, we can decompose ζ in the basis $\{1, \mathbf{j}\}$ instead of $\{\mathbf{e}_1, \mathbf{e}_2\}$ by taking $\zeta = \alpha + \beta \mathbf{j}$ and then $\zeta_{\hat{1}} = \alpha + \beta$ and $\zeta_{\hat{2}} = \alpha - \beta$. This leads to

$$|(\Delta X) (\Delta P)| \geq \frac{\hbar \sqrt{(\alpha + \beta)^2 + (\alpha - \beta)^2}}{4\sqrt{2}} = \frac{\hbar \sqrt{\alpha^2 + \beta^2}}{4}. \tag{117}$$

It is interesting to note that if we restrict BQM to SQM by setting $\zeta_{\hat{1}} = 1 = \zeta_{\hat{2}}$ or $\alpha = 1, \beta = 0$ (and indirectly $X_{\hat{1}} = X_{\hat{2}}, P_{\hat{1}} = P_{\hat{2}}$ and $|\psi_{\hat{1}}\rangle = |\psi_{\hat{2}}\rangle$), we find

$$|(\Delta X) (\Delta P)|_{BQM \rightarrow SQM} \geq \frac{\hbar}{4}, \tag{118}$$

that is $1/2$ times the standard result. Then, from bicomplex quantum mechanics, we generated a lower bound for the Heisenberg uncertainty principle that is in accord with the standard quantum mechanics. In fact, the $1/2$ factor comes from the three last terms of (104) that we neglected. Indeed, the terms that we neglected in (104) would have contributed for $\hbar/4$ to the uncertainty principle **but only** when we do the restriction $\text{BMQ} \rightarrow \text{SQM}$.

In other words, we can say that computing the **standard uncertainty principle** from BQM (in the SQM approximation) give a $1/2$ time poorer bound, compare with the complex (standard) way of computation. This, however, doesn't imply in any way that (114) is a poor approximation **in the BQM**.

6. Conclusion

With the results presented here, quantum mechanics was successfully extended to bicomplex numbers in two concrete problems, the harmonic oscillator and the Heisenberg uncertainty principle. We strongly believe that bicomplex quantum mechanics can be extended to other significant problems of standard quantum mechanics and such investigations are actually in progress. However, we think it is too early to try to give a physical interpretation to our results. We hope that this work will motivate the reader to consider generalizations of complex numbers in other significant problem of physics. We also believe that if those generalized theory do not end with some new predictions, they will at least give some crucial insight about the apparent requirement of complex numbers in physics.

7. Acknowledgments

DR is grateful to the Natural Sciences and Engineering Research Council of Canada for financial support. RGL would like to thank the Québec FQRNT Fund and the Natural Sciences and Engineering Research Council of Canada for the award of postgraduate scholarship. Both authors are very grateful to the professor Louis Marchildon. Most of this work originate from a very pleasant collaboration and discussions with him.

8. References

- Adler, S. L. (1995). *Quaternionic Quantum Mechanics and Quantum Fields*, Oxford University Press, New York.
- Birkhoff, G. & Von Neumann, J. (1936). The logic of quantum mechanics, *The Annals of Mathematics* 37(4): 823–843.
- Bourbaki, N. (2006). *Éléments de Mathématique*, Springer, Berlin.
- Charak, K., Rochon, D. & Sharma, N. (2009). Normal families of bicomplex holomorphic functions, *Fractals* 17(3): 257–268.
- Clifton, R., Bub, J. & Halvorson, H. (2003). Characterizing quantum theory in terms of information-theoretic constraints, *Foundations of Physics* 33(11): 1561–1591.
- Fuchs, C. A. (2002). Quantum theory from intuitively reasonable axioms, in A. Khrennikov (ed.), *Quantum Theory: Reconsideration of Foundations*, Växjö University Press, Växjö, pp. 463–543.
- Garant-Pelletier, V. & Rochon, D. (2009). On a generalized fatou-julia theorem in multicomplex spaces, *Fractals* 17(3): 241–255.
- Gervais Lavoie, R., Marchildon, L. & Rochon, D. (2010a). Infinite-dimensional bicomplex Hilbert spaces, *Annals of Functional Analysis* 1(2): 75–91.

- Gervais Lavoie, R., Marchildon, L. & Rochon, D. (2010b). The bicomplex quantum harmonic oscillator, *Il Nuovo Cimento* 125 B(10): 1173–1192.
- Gervais Lavoie, R., Marchildon, L. & Rochon, D. (2011). Finite-dimensional bicomplex hilbert spaces, *Advances in Applied Clifford Algebras* 21(3): 561–581.
- Marchildon, L. (2002). *Quantum Mechanics: From Basic Principles to Numerical Methods and Applications*, Springer Verlag, Berlin.
- Marchildon, L. (2004). Why should we interpret quantum mechanics?, *Foundations of Physics* 34(10): 1453–1466.
- Martineau, É. & Rochon, D. (2005). On a bicomplex distance estimation for the tetrabrot, *International Journal of Bifurcation and Chaos* 15(9): 3039–3050 .
- Penrose, R. (2005). *The Road to Reality: A Complete Guide to the Laws of the Universe*, Vintage, Londres.
- Price (1991). *An Introduction to Multicomplex Spaces and Functions*, Marcel Dekker, New York.
- Reichenbach, H. (1944). *Philosophic Foundations of Quantum Mechanics*, Dover Publications, New York.
- Rochon, D. (2000). A generalized mandelbrot set for bicomplex numbers, *Fractals* 8(4): 355–368.
- Rochon, D. (2003). On a generalized fatou-julia theorem, *Fractals* 11(3): 213–219.
- Rochon, D. (2004). A bicomplex riemann zeta function, *Tokyo Journal of Mathematics* 27(2): 357–369.
- Rochon, D. & Shapiro, M. (2004). On algebraic properties of bicomplex and hyperbolic numbers, *Anal. Univ. Oradea, fasc. math* 11: 71–110.
- Rochon, D. & Tremblay, S. (2004). Bicomplex quantum mechanics: I. the generalized Schrödinger equation, *Advances in Applied Clifford Algebras* 14(2): 231–248.
- Rochon, D. & Tremblay, S. (2006). Bicomplex quantum mechanics: II. the Hilbert space, *Advances in Applied Clifford Algebras* 16(2): 135–157.
- Schlosshauer, M. (2005). Decoherence, the measurement problem, and interpretations of quantum mechanics, *Reviews of Modern Physics* 76(4): 1267–1305.
- Stueckelberg, E. C. G. (1960). Quantum theory in real Hilbert space, *Helvetica Physica Acta* 33: 727–752.
- Stueckelberg, E. C. G. & Guenin, M. (1961). Quantum theory in real Hilbert space. II. (Addenda and errata), *Helvetica Physica Acta* 34: 621–627.
- Vaijac, A. & Vaijac, M. B. (to appear). Multicomplex hyperfunctions, *Complex Variables and Elliptic Equations* .

Correspondence, Time, Energy, Uncertainty, Tunnelling, and Collapse of Probability Densities

Gabino Torres–Vega
Physics Department, Cinvestav
Mexico

1. Introduction

Classical and Quantum Mechanics make use of different objects and they also were written on different background spaces. As a consequence, they have followed different paths regarding the mathematical objects that they use. Classical Mechanics makes use of points and functions on a real cotangent space T^*Q of a mechanical system, and makes use of differential geometry as the basic language with which the theory is developed. This is due to the existence of trajectories of single points.

On the other side, Quantum Mechanics makes use of state vectors in a complex Hilbert space, with operators, commutators, and eigenvectors, and makes use of some postulates that look weird from a classical point of view. This is a point of view that was induced by the lack of trajectories and by the use of probabilistic interpretations of state vectors.

There have been efforts to define similar classical and quantum functions that can be compared with each other. Quantum densities were written as functions on phase–space by means of integral transformations. Two of these transformations are the Wigner (Wigner, 1932, Muga & Snider, 1992, Sala, R, Brouard, S, & Muga, JG, 1993, Sala & Muga, 1994, Bracken, 2003) and the Husimi (Husimi, 1940, Torres & Frederick, 1990, 1991) transforms. They provide with a phase–space function that can be used as a classical picture of the quantum probability density. However, these functions are difficult to interpret.

An approach to classical–quantum correspondence uses quantum concepts in Classical Mechanics focusing on the eigenfunctions of the classical Liouville operator. Complex functions are introduced, together with a quantum–like inner product between phase–space functions, into the classical theory, but this leads to some inconveniences like having quantities with no physical interpretation (Koopman, 1931, Jaffé & Brumer, 1984, 1985,, Jaffé, 1988 Woodhouse, 1991). Here, we do not make use of complex quantities at all.

In this chapter, we stay with plain Classical Mechanics and we want to identify some of the classical objects that are the analogue of quantum quantities. These analogues allows us to take a point of view of classical systems similar to the one used in quantum systems. These analogues show that these theories are not that far from each other. In fact, we show that we can handle classical systems in a very similar way as it is done for quantum systems. We define eigenfunctions of classical dynamical variables and use them to define alternative representations of classical quantities and in the calculation of averages and of other quantities.

The way of handling time in classical and quantum physics, as well as in other theories in physics, has been a subject of the interest of many researchers for a long time now (Aharonov et al, 1961, Allcock, 1969, Muga et al, 1998, Muga & Leavens, 2000, Muga, JG, Sala–Mayato, R and Egusquiza, IL (ed), 2002, 2008, Galapon, 2002, Galapon et al, 2004, Isidro, 2005, Torres, 2007, 2009, Delgado et al, 1997, Giannitrapani, 1997, Halliwell, 1999, Hegerfeldt et al, 2004, Kijowski, 1974, Kobe et al, 1993, 1994, Kochański et al, 1999, Leavens, 2002, León, 1997, Rovelli, 1990, 1991). We make use of those developments and further develop and apply those ideas in this chapter.

Looking for classical analogues of quantum objects is of help in clarifying the physical meaning of the latter, and it shows us that we can also make use of the quantum language in the classical realm, taking a path in parallel to the direction that Quantum Mechanics theory has taken.

Earlier treatments of time in Classical Mechanics make use of canonical transformations. However, this type of treatment needs to introduce a "tempus" variable which is not related with physical time and has no physical interpretation. One can see applications of this theory in the treatment of tunnelling through a potential barrier (Razavy, 1967, 1971, Kobe, 2001). Here we do not need to introduce additional variables.

In quantum Mechanics, the description of the evolution of wave packets can be carried out in terms of the eigenfunctions of the Hamiltonian operator. This is the operator that appears in the evolution equation for wave functions. Then, a way of approaching the evolution of probability densities in classical phase–space makes use of the eigenfunctions of the Liouville operator (Jaffé, 1988, Jaffé & Brumer, 1984, 1985). That seems to be a reasonable approach because the classical evolution equation of probability densities is determined by the Liouville operator, precisely. However, some of these eigenfunctions are complex with no physical interpretation. Here, we focus on the eigen surfaces and eigen functions of the dynamical quantities instead.

Conserved quantities have been used to construct directional derivatives (Jaffé, 1988, Jaffé & Brumer, 1985), but nothing has been said about the use of the use of pairs of conjugate variables. Here we propose to also use conjugate dynamical variables as generators of translations in phase–space. With the use of conserved quantities, the motion of phase–space points is kept on the energy shell surface, but with a conjugate function, points can leave that shell.

On the other hand, we are interested on recognising that many of the concepts that are used in the theory of Quantum Mechanics can also be used in the study of classical systems, a point of view which is closer to Quantum Mechanics than other approaches like Geometric Mechanics or Geometric Quantisation. Our approach makes use of eigen objects, operators, and commutators, in a similar way as is done in Quantum Mechanics. This approach will lead to a plausible classical interpretation of the collapse of a quantum wave function; the goal of this paper. A benefit of our approach is that it is of help in the understanding of quantum phenomena.

We will be working with conservative Hamiltonian systems, systems for which Hamilton's equations of motion apply, without an additional "tempus variable" involved.

Throughout the text, we will be considering as a model system the nonlinear oscillator with dimensionless Hamiltonian given by (José and Saletan, 1998)

$$\mathcal{H}(z) = \frac{p^2}{2} + \frac{k}{2} \left(\sqrt{a^2 + q^2} - l \right)^2 . \quad (1)$$

This Hamiltonian describes the motion of a bead that slides on a horizontal bar and is acted on by a spring attached to a fixed point a distance a from the bar. The force constant of the spring is k , and l is its natural length, so that $\sqrt{a^2 + q^2} - l$ is its stretch. The fixed points for this system are located at

$$q_0 = 0, \pm\sqrt{l^2 - a^2}, \quad p_0 = 0. \quad (2)$$

There is only a minimum of the potential function when $a > l$, and there are two minima and one maximum when $a < l$.

We will also consider an application of our results to the tunnelling through a potential barrier.

2. Conjugate variables and representations

Let us consider a Poisson manifold $(T^*Q, \{\bullet, \bullet\})$ associated to a classical system, with $\{\bullet, \bullet\}$ the usual Poisson bracket, which for two functions $F(z)$ and $G(z)$ is defined as

$$\{F, G\}(z) = \frac{\partial F(z)}{\partial q^i} \frac{\partial G(z)}{\partial p_i} - \frac{\partial G(z)}{\partial q^i} \frac{\partial F(z)}{\partial p_i}, \quad (3)$$

where $z = (q, p)$, $q = (q^1, \dots, q^n)$, $p = (p_1, \dots, p_n)$ is a point on T^*Q .

We will be mainly concerned with pairs of conjugate variables and some of the consequences of that relationship between them. Conjugate variables are the variables that are related by a constant Poisson bracket, $\{F, G\}(z) = 1$, in Classical Mechanics and by a constant commutator, $[\hat{F}, \hat{G}] = i\hbar$, in Quantum Mechanics, between the corresponding quantum operators \hat{F}, \hat{G} .

The dynamics of classical systems usually is described in terms of the pairs of conjugate variables q^i and p_i . These pairs of variables are related by a constant Poisson bracket,

$$\{q^i, p_j\} = \delta_j^i. \quad (4)$$

The domain in which this relationship is valid is $\mathcal{D} = \mathbb{R}^n \times \mathbb{R}^n$. They are the coordinates for describing the evolution of a classical system, and each variable, usually, take continuous values from $-\infty$ to ∞ or on some subset of it. Time is a parameter in terms of which the motion of point particles can be described.

The quantum position \hat{Q} and momentum \hat{P} operators are related by a constant commutator

$$[\hat{Q}^i, \hat{P}_j] = i\hbar\delta_j^i, \quad (5)$$

and their eigenfunctions cannot be normalised in the conjugate space, meaning that they are not part of a Hilbert space. However, these eigenfunctions are used as coordinates (as a representation).

In Quantum Mechanics, the commutator between the time operator \hat{T} and the Hamiltonian operator \hat{H} is assumed to be

$$[\hat{T}, \hat{H}] = i\hbar, \quad (6)$$

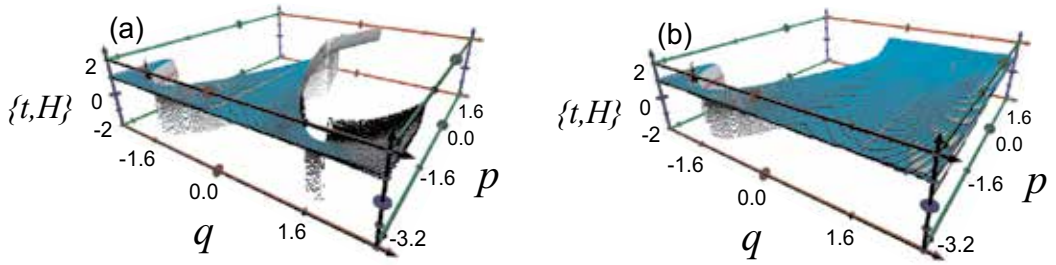

Fig. 1. Values of the Poisson bracket $\{t, H\}(z)$ for the nonlinear oscillator with $a = 1$, $l = 2$, and $k = 9.8$. The turquoise points indicate that the Poisson bracket evaluates to one there, whereas in the red points the value is zero. (a) $X = 0$, and (b) X the location of the right minima of the potential. Dimensionless units.

so that they are a pair of conjugate operators. We find a similar relationship in the classical regime, the Poisson bracket between time and energy is equal to one

$$\{t, H\}(z) = \frac{\partial t}{\partial q^i} \frac{\partial H}{\partial p_i} - \frac{\partial H}{\partial q^i} \frac{\partial t}{\partial p_i} = \frac{\partial t}{\partial q^i} \frac{\partial q^i}{\partial t} + \frac{\partial p_i}{\partial t} \frac{\partial t}{\partial p_i} = \frac{dt}{dt} = 1, \quad (7)$$

where we have made use of Hamilton's equations of motion

$$\frac{dq^i}{dt} = \frac{\partial H}{\partial p_i}, \quad \frac{dp_i}{dt} = -\frac{\partial H}{\partial q^i}, \quad (8)$$

and of the chain rule. We argue that these variables, energy and time, can also be used as an alternative coordinate system. In these coordinates, motion of conservative systems becomes quite simple, one of the variables is kept constant and the other just increases. What we have here is the set of canonical variables of group theory.

An object that is inherent to a Poisson bracket equal to one is the domain in which that equality holds. For the nonlinear oscillator, the values that the Poisson bracket take have been plotted in figure 1, for two choices of reference zero time surface. The way in which those values were obtained is explained below. The domain of the energy, $\mathcal{D}(\mathcal{H})$, is the whole of phase-space, but the domain of time, $\mathcal{D}(t)$, is not. The domain of the Poisson bracket is the intersection of these domains, $\mathcal{D}(\mathcal{H}) \cap \mathcal{D}(t)$, which, in this case, coincides with the domain of time. In Quantum Mechanics, we have to consider the intersection of the domains of $\hat{H}\hat{T}$ and of $\hat{T}\hat{H}$, $\mathcal{D}(\hat{H}\hat{T}) \cap \mathcal{D}(\hat{T}\hat{H})$.

The new coordinates, (t, E) , are a bit different from (p, q) because to a value of the energy correspond two values of p_i (usually p_i appears as p_i^2 in the Hamiltonian) so that E is bounded from below. It is then necessary to make the distinction between the cases of positive or negative momentum.

In general, the explicit expression in terms of z of one of the variables related by a constant Poisson bracket is known but not the other, as is the case of energy (known) and time (not known). Below, we will show how to generate the unknown one (time) using the equations of motion. We can generate the unknown variable because they are related by the Poisson bracket precisely.

In Quantum Mechanics we have a similar situation. Usually, quantum dynamics is analysed in coordinate or momentum representations, but we can also change to energy or time

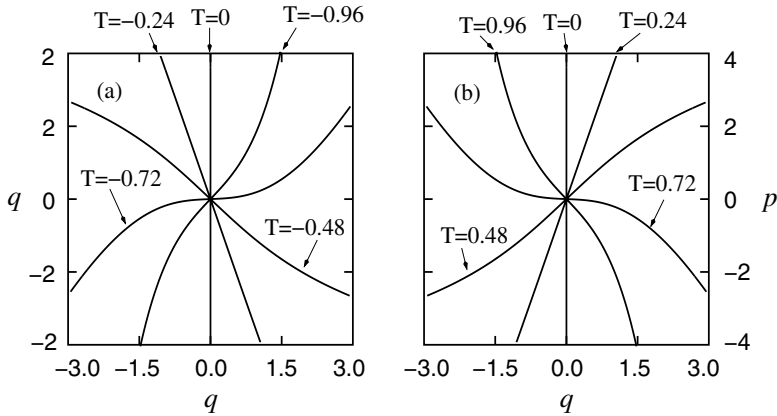

Fig. 2. Time surfaces for the nonlinear oscillator with $a = 1$, $l = 2$, and $k = 9.8$. (a) Negative times and (b) positive times. The initial curve is $q = 0$. Dimensionless units.

representations. The energy representation is well known (the energy eigenstates) but the time representation is not. However, because time is conjugate to energy, we can define time eigenstates and then use them as an alternative representation of quantum states, in the same way as it is done in classical systems (see below).

3. Generating the time coordinate system

Let us consider a cotangent space T^*Q with coordinates $z = (q, p)$. Given the Hamiltonian $H(z)$ of a classical system, Hamilton's equations of motion

$$\frac{dz}{dt} = X_H, \quad X_H = \left(\frac{\partial H}{\partial p}, -\frac{\partial H}{\partial q} \right), \quad (9)$$

use the conjugate variable to the Hamiltonian, time, as a parameter for describing the motion of a particle on the energy shell. The origin of time on the integral lines of equation (9) is chosen arbitrarily and, usually, it is different for each integral line.

We can generate a time coordinate system in T^*Q so that we can have the time variable in terms of (p, q) . A point in cotangent space T^*Q can be propagated according to the dynamical system defined by equations (9). These points will move along the surfaces of constant H so that the value of H does not change but the value of t does. In order to get a coordinate system for time in T^*Q , we define constant t surfaces in T^*Q . A hypersurface $\Sigma_0(z)$ that crosses the constant H surfaces is chosen as the reference, the origin of t , and by propagating it we will obtain surfaces $\Sigma_t(z)$ corresponding to other values of time, so obtaining the desired coordinate system for t in T^*Q .

We will use the surface $q^1 = X$ as the initial time surface, and we will make a distinction on the sign of the momentum of these points giving rise to two time eigensurfaces:

$$\Sigma_{t=0}^{\pm}(z) = \{z | q^1 = X, \pm p_1 > 0\}. \quad (10)$$

In figures 2 and 3 there are examples of the surfaces that comprise the time coordinate system in the case of the nonlinear oscillator. The initial surfaces are $q^1 = X$, with $X = 0, 1.5$. Under this convention, the time values for each point in phase-space are shown in Fig. 4. They

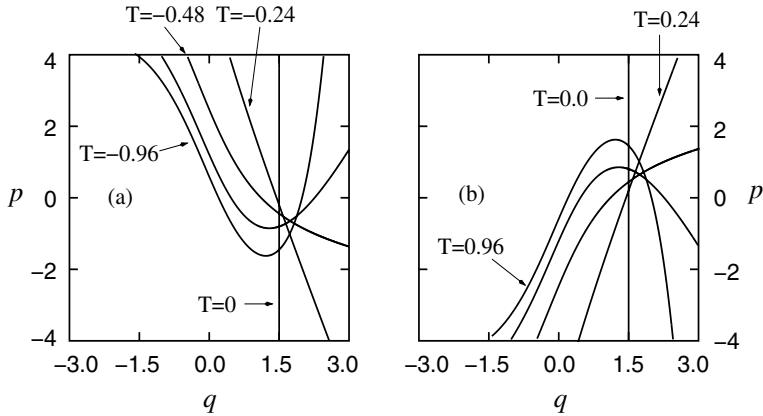

Fig. 3. Time surfaces for the nonlinear oscillator with $a = 1$, $l = 2$, and $k = 9.8$. (a) Negative times and (b) positive times. The initial curve is $q = 1.5$. Dimensionless units.

are the shortest times that it would take to a particle with z as final position to arrive at or depart from $q^1 = X$. These values are the classical analogue of the quantum time operator \hat{T} . Note that not all points in T^*Q will arrive or depart from $q^1 = X$. For this reason, some regions of T^*Q are not part of the domain of the Poisson bracket equal to one (see Fig. 1). Points on the separatrix move quite slow as seen on the plot. Time reversal symmetry, i.e. the transformation $(t, p) \rightarrow (-t, -p)$ is evident in these figures.

The quantum procedure that can be used to generate time eigenstates is very similar to the classical one. The quantum initial state, in momentum space (in one dimension, for simplicity),

$$\langle p|t=0\rangle = \frac{1}{\sqrt{2\pi\hbar}}e^{-ipX}, \quad (11)$$

is the equivalent to the line $q = X$ in phase-space. The squared modulus of this state in momentum space is constant for all values of p , but it is a delta function centred at $q = X$ in coordinate space. This is the reference state for time. The propagation of it, i.e. the state

$$\langle p|t\rangle = \frac{1}{\sqrt{2\pi\hbar}}e^{-it\hat{H}/\hbar}e^{-ipX}, \quad (12)$$

is the time coordinate system that can be used for a time representation. These states cannot be normalised.

Quantum time eigenstates have been in use for a long time now without realizing it. Let us rewrite the expression for a wave packet in the coordinate representation in terms of the momentum wave packet as (unless otherwise stated the integrals are taken from $-\infty$ to ∞)

$$\begin{aligned} \psi(x;t) &= \frac{1}{\sqrt{2\pi\hbar}} \int dp e^{ipx} \psi(p;t) = \frac{1}{\sqrt{2\pi\hbar}} \int dp e^{ipx} e^{-it\hat{H}/\hbar} \psi(p) \\ &= \frac{1}{\sqrt{2\pi\hbar}} \int dp \psi(p) e^{it\hat{H}/\hbar} e^{ipx} = \frac{1}{\sqrt{2\pi\hbar}} \int dp \psi(p) (e^{-it\hat{H}/\hbar} e^{-ipx})^* \\ &= \langle t|\psi\rangle, \end{aligned} \quad (13)$$

which is the inner product between the time eigenstate $|t\rangle$ and a ket $|\psi\rangle$.

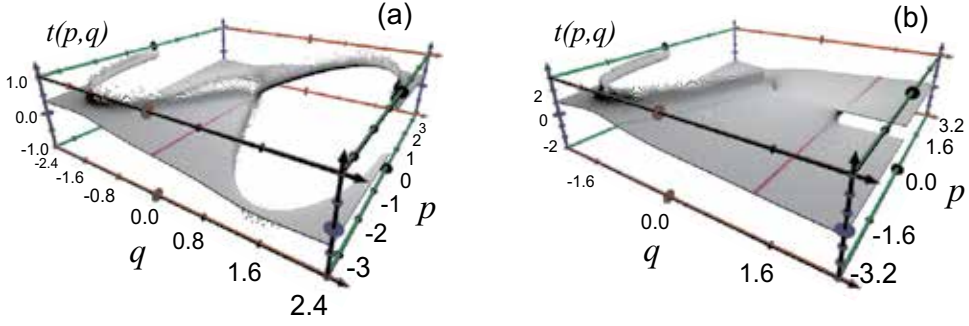

Fig. 4. Time values $t(z)$ for the nonlinear oscillator with $a = 1$, $l = 2$, and $k = 9.8$. (a) $X = 0$ and (b) $X = 1.5$. The points coloured in cyan indicate the zero time points. Dimensionless units.

4. Time and energy eigenfunctions

Quantum energy eigenstates $|e\rangle$ are the states characterised by just being multiplied by the corresponding eigenvalue ϵ after the application of the Hamiltonian operator, i.e. $\hat{H}|e\rangle = \epsilon|e\rangle$. We can take as the classical analogue of the quantum energy eigenstate to a unit density with the constant energy shells as support,

$$v_{\epsilon}^{\pm}(z) = \delta(z - \Sigma_{\epsilon}^{\pm}(z)) \quad (14)$$

where

$$\Sigma_{\epsilon}^{\pm}(z) = \{z | H(z) = \epsilon, \pm p_1 > 0\}. \quad (15)$$

If we evaluate the Hamiltonian function on the support $\Sigma_{\epsilon}^{\pm}(z)$ of this function, we will obtain the value ϵ . The density $v_{\epsilon}^{\pm}(z)$ is the classical analogue of the quantum density $|\langle q | e^{\pm} \rangle|^2$. Now, a unit density with the time eigen surfaces $\Sigma_t^{\pm}(z)$ as support,

$$v_t^{\pm}(z) = \delta(z - \Sigma_t^{\pm}(z)),$$

is the analogue of the squared magnitude of the quantum time eigenfunction $|\langle q | t \rangle|^2$. In the realm of functions on T^*Q , the classical time eigen density is generated by starting with $v_{t=0}^{\pm}(z)$ and propagating it with the classical propagator as

$$v_t^{\pm}(z) = e^{-t\mathcal{L}(z)} v_{t=0}^{\pm}(z), \quad \mathcal{L}(z) = X_H \cdot \nabla, \quad (16)$$

where the vector field is $X_H = (\partial H / \partial p, -\partial H / \partial q)$. If we evaluate time on the support $\Sigma_t^{\pm}(z)$ of the eigen density $v_t^{\pm}(z)$ we will get the value t .

The unboundedness of the eigensurfaces of a dynamical variable usually implies a problem with the normalisation of functions with them as a support so that they cannot become probability densities. However, we need to include that type of variables to have a representation of quantities in T^*Q . These eigen densities, $v_{\epsilon}(z)$ and $v_t(z)$ are the classical analogues of the quantum representation vectors $\langle \epsilon |$, and $\langle t |$, respectively. But recall that some of these quantum vectors are not part of the Hilbert space.

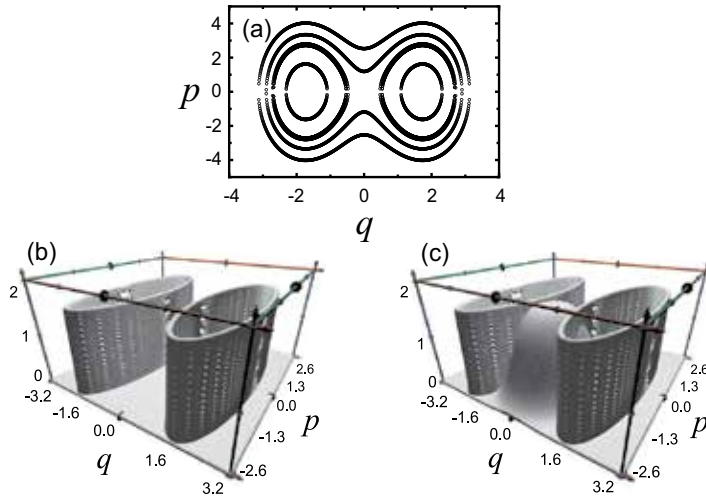

Fig. 5. Classical energy densities corresponding to the quantum eigenvalues for the nonlinear oscillator. (a) Energy curves in phase-space, (b) classical eigendensity for one energy value, and (c) the overlap between the energy eigendensity and a Gaussian density. Dimensionless units.

5. Uncertainty of conjugate eigenfunctions

In Quantum Mechanics, the average of an operator \hat{F} when the system is in one of its eigenfunctions $|f\rangle$ is the corresponding eigenvalue f , i.e. $\langle f|\hat{F}|f\rangle = f$, and the width vanishes, i.e. $\Delta\hat{F} = \sqrt{\langle f|\hat{F}^2|f\rangle - \langle f|\hat{F}|f\rangle^2} = 0$. However, for the conjugate operator \hat{G} , the average $\langle f|\hat{G}|f\rangle$ and width $\Delta\hat{G} = \sqrt{\langle f|\hat{G}^2|f\rangle - \langle f|\hat{G}|f\rangle^2}$, in the states $|f\rangle$, are not defined. A property in agreement with Heisenberg's uncertainty principle, $(\Delta\hat{F})^2(\Delta\hat{G})^2 \geq \hbar^2\langle[\hat{F}, \hat{G}]/i\hbar\rangle^2/4$, because when one of the observables, in this case \hat{F} , is well defined, the conjugate observable \hat{G} becomes undefined.

Note that we also observe this characteristic on the eigensurfaces of dynamical variables of classical systems. In the classical case, with the nonlinear oscillator as an example (see figure 5), on the energy eigen surfaces $\Sigma_\epsilon^\pm(z)$, the energy is well defined with no dispersion, i.e. there is a zero width in energy. However, they span values of time ranging from minus infinity to infinity. And vice-versa, the time eigen density has zero width in time but they include an unbounded set of energy values (see figures 2 and 3). Then, we can say that the classical eigendensities $\nu_\epsilon^\pm(z)$ and $\nu_t^\pm(z)$ correspond to the squared magnitude of the quantum energy, $|\epsilon^\pm\rangle$, and time, $|t^\pm\rangle$, eigenstates, respectively,

$$\nu_\epsilon^\pm(z) \leftrightarrow |\epsilon^\pm\rangle\langle\epsilon^\pm|, \quad \nu_t^\pm(z) \leftrightarrow |t^\pm\rangle\langle t^\pm|. \quad (17)$$

In Fig. 5, we show few classical energy curves, for the nonlinear oscillator, with energy values equal to the quantum eigenvalues. Note that the separatrix is excluded from these values. There is also, a schematic representation of a classical unit density with one of the energy curves as support.

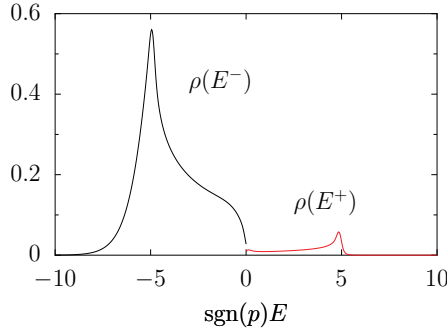

Fig. 6. Classical energy representation $\rho(\epsilon^\pm)$ of a Gaussian probability density $e^{-(q-q_0)^2/2\sigma^2-2\sigma^2(p-p_0)^2}/\sqrt{2\pi}\sigma$ centred at $(q, p) = (0, -1)$ for the nonlinear oscillator with $a = 1, l = 2, k = 9.8$, and $\sigma = .8$. The peaks are located at the energy of the separatrix. This is the classical analogue of the squared magnitude of the energy representation of a quantum state $|\langle \epsilon^\pm | \psi \rangle|^2$. Dimensionless units.

6. Energy and time representations

With the help of the classical energy eigendensities (14), the energy representation of a probability density $\rho(z)$ is defined as

$$\rho(\epsilon^\pm) = \int dz v_\epsilon^\pm(z) \rho(z). \quad (18)$$

Note that we have reduced the representation from one with $2n$ variables, namely p_i and q^i , to one with only one variable, ϵ^\pm . Then, it is not possible to recover the original density $\rho(z)$ from the reduced one $\rho(\epsilon^\pm)$. An example of these reduced densities is found in Fig. 6 for the nonlinear oscillator.

Recall that the quantum energy representation is obtained as the inner product between the energy eigenstate, $|\epsilon\rangle$, and the wave function, $|\psi\rangle$, separated into negative and positive momentum parts, as

$$\psi(\epsilon^\pm) = \int_0^\infty dp \langle \epsilon | \pm p \rangle \langle \pm p | \psi \rangle. \quad (19)$$

Thus, the squared magnitude of this quantity is the analogue to the classical energy representation of a probability density of equation (18). Since the quantum spectrum is discrete for the nonlinear oscillator, only few points will be found in the energy representation, as can be seen in Fig. 7.

For a classical time representation of a probability density, we calculate the overlap between the time eigendensity Eq. (16) with a probability density $\rho(z)$

$$\rho^\pm(t) = \int dz v_t^\pm(z) \rho(z). \quad (20)$$

This is also a reduced representation of the density $\rho(z)$ because it only depends on one variable. For the nonlinear oscillator, an example of this representation is shown in Fig. 8. The time representation depends on the zero-time reference surface $\Sigma_{t=0}(z)$. Different regions

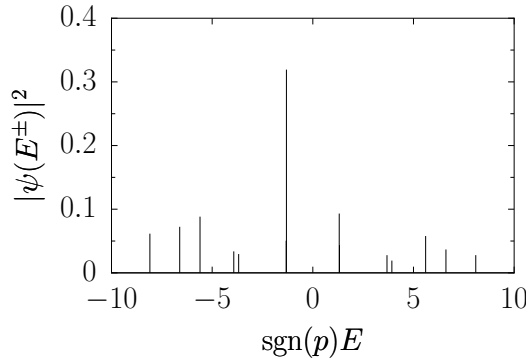

Fig. 7. Quantum energy representation of the Gaussian state

$e^{-(q-q_0)^2/4\sigma^2 - ip_0(q-q_0/2)} / \sqrt{\sigma\sqrt{2\pi}}$ centred at $(q, p) = (0, -1)$, with $\sigma = 0.2$, and for the nonlinear oscillator. Dimensionless units.

of phase-space are available depending upon the choice of X , the location of the zero-time reference surface.

A quantum time representation is obtained in a similar way: the wave packet $|\psi\rangle$ is projected onto the time eigenstates $|t^\pm\rangle$ of equation (12),

$$\psi(t^\pm) = \int_0^\infty \langle t | \pm p \rangle \langle \pm p | \psi \rangle . \quad (21)$$

The squared magnitude of this projection is the desired quantum time probability density. For the nonlinear oscillator, the quantum time probability density looks like the ones shown in Fig. 9.

The time width of a given probability density that can be calculated with our procedure is a static property. It is a consequence of a probability density having a non zero width on phase-space in a particular set of coordinates. Other possibility is the time dependence and time width due to the actual motion of the system.

The following is not possible for quantum systems, but a joint representation is obtained with the joint eigen surfaces and densities of energy and time,

$$\Sigma_{\epsilon\tau}^\pm(z) = \{z | H(z) = \epsilon, t(z) = \tau, \pm p_1 > 0 \text{ when } \tau = 0\} , \quad (22)$$

$$v_{\epsilon\tau}^\pm(z) = \delta(z - \Sigma_{\epsilon\tau}^\pm(z)) . \quad (23)$$

The energy-time representation of a classical probability density is then given by

$$\rho^\pm(\epsilon, \tau) = \int dz v_{\epsilon\tau}^\pm(z) \rho(z) . \quad (24)$$

This representation has no quantum counterpart because energy and time cannot be determined simultaneously in quantum systems. An example of this representation is found in Fig. 10 for the nonlinear oscillator.

We can say that functions like the classical energy or time eigenstates have been in use for a long time now in an unnoticed way. We can rewrite a time dependent probability density in

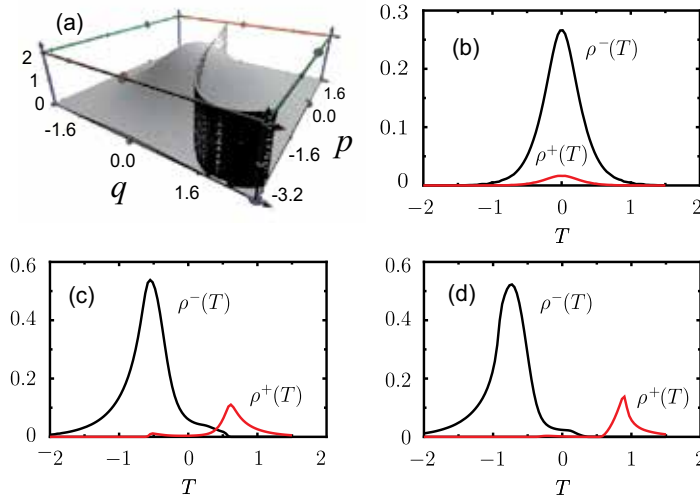

Fig. 8. Time eigendensity and representation for the nonlinear oscillator with $a = 1$, $l = 2$, and $k = 9.8$. (a) Schematic representation of the overlap between a time eigenfunction and a Gaussian probability density centred at $(q, p) = (0, -1)$, and the time representation $\rho^\pm(T)$ for (b) $X = 0$, (c) X the positive fixed point, and (d) for $X = 2.2$. Dimensionless units.

phase-space in terms of the phase-space and time eigenfunctions. The following shows this

$$\begin{aligned}
 \rho(z; t) &= \int dz' \delta(z' - z) \rho(z'; t) = \int dz' \delta(z' - z) e^{t\mathcal{L}(z')} \rho(z') \\
 &= \int dz' \rho(z') e^{-t\mathcal{L}(z')} \delta(z' - z) + \text{b.t.} \\
 &= \int dz' \rho(z') v_{zt}(z') + \text{b.t.}, \tag{25}
 \end{aligned}$$

where

$$v_{zt}(z') = e^{-t\mathcal{L}(z')} \delta(z' - z), \tag{26}$$

and b.t. stands for the boundary terms arising from the integration by parts (throughout the text partial integration is used with the assumption that contributions from the boundaries always vanish). These terms usually evaluate to zero because probability densities vanish at the boundaries. What we have here is the motion of single points of phase-space weighted by the density at the initial place of the points. This is a way of moving functions on phase-space according to the motion of phase-space eigendensities, an integral operator form of the classical propagator $e^{t\mathcal{L}(z)}$.

The classical time representation $\rho(\tau)$ can be written in terms of the initial time eigendensities and the probability density at time τ , or in terms of the eigendensities at time τ and the initial

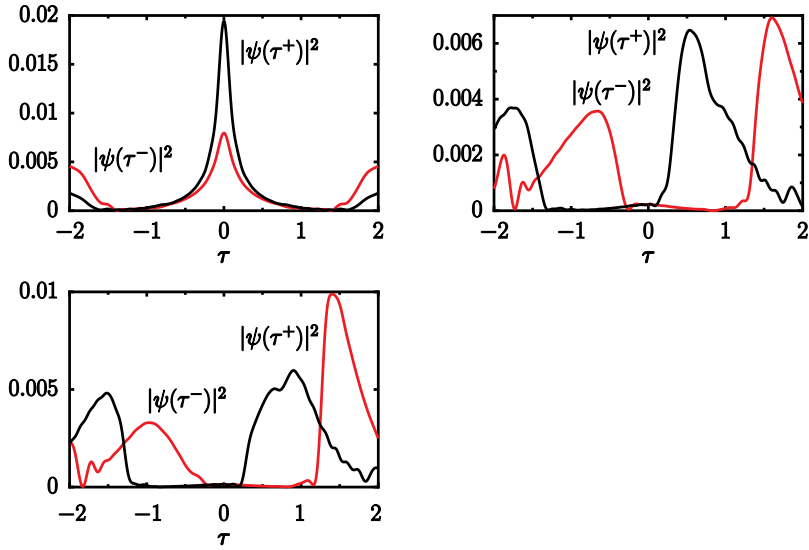

Fig. 9. Quantum time representation of the Gaussian state $e^{-(q-q_0)^2/4\sigma^2 - ip_0(q-q_0/2)} / \sqrt{\sigma\sqrt{2\pi}}$ centred at $(q, p) = (0, -1)$, with $\sigma = 0.2$, and for the nonlinear oscillator. The zero-time reference state is located at (a) $X = 0$, (b) X the location of the right fixed point, and (c) $X = 2$. Dimensionless units.

probability density,

$$\begin{aligned}
 \rho(\tau) &= \int dz v_\tau(z) \rho(z) = \int dz \rho(z) e^{-\tau \mathcal{L}_H} \delta(z - \Sigma_{\tau=0}(z)) \\
 &= \int dz \delta(z - \Sigma_{\tau=0}(z)) e^{\tau \mathcal{L}_H} \rho(z) + \text{b.t.} = \int dz \delta(z - \Sigma_{\tau=0}(z)) \rho(z; t) + \text{b.t.} \\
 &= \int dz v_{\tau=0}(z) \rho(z; t) + \text{b.t.} .
 \end{aligned} \tag{27}$$

Then, we do not need to propagate the time eigendensity and the probability density, only the evolution of one of them is enough.

7. Collapse of probability densities

In the process known as the quantum collapse of wave functions, a quantum system represented by the wave function $|\psi\rangle$ ends up in the eigenstate $|g\rangle$ of the operator \hat{G} , with probability $|\langle g|\psi\rangle|^2$, after a measurement of the quantity represented with the operator \hat{G} . This is a postulate of Quantum Mechanics introduced to ensure a continuity of measurements when the same property of a quantum system is measured several times. This postulate seems a bit awkward at first sight, but it can be understood in classical terms, as we will see in this section.

A classical image of the quantum collapse process is one in which an apparatus selects from the particles of an ensemble $\rho(z)$ only the ones with a z that gives the observed value g of $G(z)$, reducing the domain of $\rho(z)$ from T^*Q to $\Sigma_g(z)$, i.e. $\rho(z) \rightarrow \rho(\Sigma_g)$. The probability of

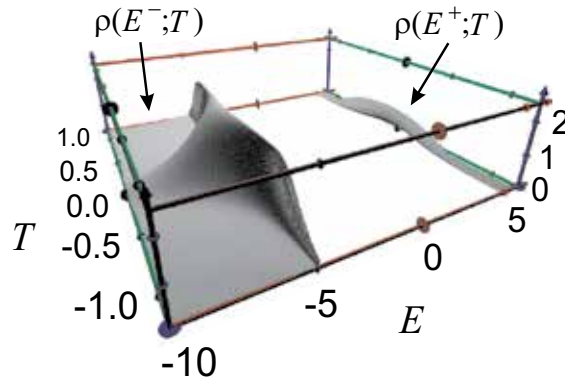

Fig. 10. Classical energy–time representation of a Gaussian density, centred at $(q, p) = (0, -1)$, for the nonlinear oscillator with $a = 1, l = 2, k = 9.8, X = 0$, and $\sigma = .8$. Dimensionless units.

measuring the value g is $\rho(g) = \int dz v_g(z) \rho(z)$. Since the support of ρ is reduced to Σ_g , an afterwards measurement of $G(z)$ will return the expected value of g .

An example of this is the following. Let us assume that a beam of particles is travelling to the right and that when this beam crosses the origin of coordinates, a disc with a hole in it is rotating letting the crossing of only a part of the beam. The selected particles can be labelled as having $t = 0$. We can assert that the selected particles will have a time t afterwards, and a wide range of values of energy.

8. An application to the tunnelling through a potential barrier

A straightforward application of the results found in previous sections is the determination of tunnelling times through a potential barrier. There are several ways of calculating tunnelling transmission coefficients (Muga, 1991, Wigner, 1972, del Barco, 2007, Kobe, 2001) and tunnelling times. We consider the calculation of tunnelling times that makes use of time averages (Wigner, 1972, del Barco, 2007). Other approaches introduce a "tempus" variable, a variable which is not related to physical time (Kobe, 2001).

Time eigenfunctions provide a sound basis for the use of a constant coordinate in the calculations of time averages that Wigner and other authors use (Wigner, 1972, del Barco, 2007). Our results also show that it is not necessary to consider "initial conditions giving the state of the system for all times but only for a single value of one of the spatial coordinates" as Wigner required, because it is the time eigenstate the quantity that has that property, and it can be determined.

In Quantum Mechanics, it is common the use of the average time, when the system is in the state $|\psi\rangle$, in the determination of tunnelling times. According to equation (13), the average time, at fixed position $q^1 = X$, can be written in terms of the time eigenstates as follows

$$\langle t(X) \rangle \equiv \frac{\int dt |\psi(X;t)|^2 t}{\int dt |\psi(X;t)|^2} = \frac{\int dt |\langle t|\psi\rangle|^2 t}{\int dt |\langle t|\psi\rangle|^2} = \frac{\int dt \langle \psi|t\rangle t \langle t|\psi\rangle}{\int dt \langle \psi|t\rangle \langle t|\psi\rangle},$$

with X fixed. We note that the time eigenkets can be used to form projection \hat{P}_X and time \hat{T}_X operators with them. These operators project onto the subspace that is available to wave

functions that can depart or arrive at $q^1 = X$. They are defined as

$$\hat{P}_X \equiv \int dt |t\rangle\langle t|, \quad \hat{T}_X \equiv \int dt |t\rangle t \langle t|. \quad (28)$$

With these operators, the time average, at fixed position, is written as the ratio

$$\langle t(X) \rangle = \frac{\langle \hat{T}_X \rangle}{\langle \hat{P}_X \rangle}. \quad (29)$$

For the classical case, and according to equation (20), the average of time, for fixed $q^1 = X$, is defined as

$$\bar{t}(X) = \frac{\int dt t \rho(t)}{\int dt \rho(t)} = \frac{\int dt t \int dz v_t(z) \rho(z)}{\int dt \int dz v_t(z) \rho(z)}. \quad (30)$$

We note that we need of two functions. One that collects the points that can arrive or depart from $q^1 = X$,

$$P_X(z) \equiv \int dt v_t(z), \quad (31)$$

and another,

$$t_X(z) \equiv \int dt t v_t(z), \quad (32)$$

which can be considered as a classical time probe function for the subspace determined by the initial time surface $\Sigma_{\tau=0}(z)$. With these definitions, the time average can be written as follows

$$\bar{t}(X) = \frac{\langle t_X \rangle}{\langle P_X \rangle}, \quad (33)$$

a result which is similar to the quantum average, equation(29).

The interpretation of the time distributions is that the time eigenstates are used as probe functions that identify the amount of probability that has a particular value of time and sums those contributions.

Thus, Wigner's annotation concerns the time eigendensities. But this is no problem at all because we know them for all time and single value of one of the spatial coordinates, initially.

9. Remarks

We can say that conjugate variables can be used to generate pairs of coordinate systems in the phase-space of classical systems. The eigensurfaces of these variables might cover an unbounded region of T^*Q and then can be used to write other dynamical quantities in terms of them. A unit density with these eigensurfaces as support cannot be normalised and then cannot be used as probability densities in T^*Q .

A similar thing occurs in quantum systems. The eigenstates of pairs of conjugate operators can be used as vectors with which quantum states and operators can be represented. In general the coordinate, momentum, or time eigenstates cannot be normalised. They are not part of

the Hilbert space, so that they cannot be a wave function. However, they are needed so that we can have a representation of other dynamical quantities.

There are many other aspects of Quantum Mechanics that can be analysed in the classical realm. The classical analysis in the terms done in this chapter is useful because it shows that many of the objects found in Quantum theory are also present in the Classical theory, and that they are of help in the understanding of quantum phenomena.

In future work we will study other properties of quantum systems, like the meaning of the Pauli theorem (Pauli, 1926), a theorem that prevents the existence of an hermitian time operator.

10. References

- [1] Aharonov, Y and Bohm, D (1961), *Phys Rev* vol. 122, pp. 1649.
- [2] Allcock, GR (1969), *Ann Phys* vol. 53, pp. 253
- [3] Allcock, GR (1969), *Ann Phys* vol. 53, pp. 286
- [4] Allcock, GR (1969), *Ann Phys* vol. 53, pp. 311
- [5] Bracken, AJ (2003), *J Phys A: Math Gen*, vol. 36, pp. L329
- [6] del Barco, O. (2007), *Phys Stat Sol B*, vol. 244, pp. 2055.
- [7] Delgado, V and Muga, JG (1997), *Phys Rev A*, vol. 56, pp. 3425
- [8] Galapon, EA (2002), *Proc R Soc Lond A* vol. 458, 451
- [9] Galapon, EA, Caballar, RF, Bahague Jr, RT, (2004), *Phys Rev Lett*, vol. 93, pp. 180406
- [10] Giannitrapani, R (1997), *Int J Theor Phys*, vol. 36, pp. 1575
- [11] Halliwell, JJ (1999), *Prog Theor Phys*, vol. 102, pp. 707
- [12] Hegerfeldt, GC and Seidel, D (2004), *Phys Rev A*, vol. 70, pp. 012110
- [13] Husimi, K (1940), *Proc Phys Math Soc Jpn* vol. 22, pp. 264
- [14] Isidro, JM (2005), *Phys Lett A*, vol. 334, pp. 370
- [15] Jaffé, Charles and Brumer, Paul (1984), *J Phys Chem*, vol. 88, pp. 4829.
- [16] Jaffé, Charles and Brumer, Paul (1985), *J Chem Phys*, vol. 82, pp. 2330.
- [17] Jaffé, Charles (1988), *J Chem Phys*, vol. 88, pp. 7603.
- [18] José, Jorge V. and Saletan, Eugene J. (1998), *Classical dynamics. A contemporary approach*, Cambridge University Press, ISBN 0-521-63176-9,, Cambridge, UK.
- [19] Kijowski, J (1974), *Rep Math Phys*, vol. 6, pp. 361
- [20] Kobe, Donald H (1993), *Am J Phys*, vol. 61, pp. 1031
- [21] Kobe, Donald H and Aguilera-Navarro, VC (1994), *Phys Rev A*, vol. 50, pp. 933
- [22] Kobe, Donald H., Iwamoto, Hiromi, Goto, Mario and Aguilera-Navarro, Valdir C. (2001), *Phys Rev A* vol. 64, pp. 022104.
- [23] Kocharński, Piotr and Wódkiewicz, Krzysztof (1999), *Phys Rev A*, vol. 60, pp. 2689
- [24] Koopman, BO (1931), *Proc Natl Acad Sci USA*, vol. 17, pp. 315.
- [25] Leavens, CR (2002), *Phys Lett A*, vol. 303, pp. 154
- [26] León, J (1997), *J Phys A*, vol. 30, pp. 4791
- [27] Muga, JG (1991), *J Phys A: Math Gen*, vol. 24, pp. 2003
- [28] Muga, JG and Snider, RF (1992) *Europhys Lett*, vol. 19, pp. 569
- [29] Muga, JG (1998), *Superlattices Microstruct*, vol. 23, 833
- [30] Muga, JG and Leavens, CR (2000) *Physics Reports* vol. 338, pp. 353
- [31] Muga, JG, Sala-Mayato, R and Egusquiza, IL (ed) (2002) *Time in Quantum Mechanics (Lecture Notes Physics Monographs vol. 72)* (Berlin, Springer)

- [32] Muga, JG, Sala-Mayato, R and Egusquiza, IL (ed) (2008) *Time in Quantum Mechanics (Lecture Notes Physics vol. 734)* (Berlin, Springer)
- [33] Pauli, W (1926) *Handbuch der Physik*, vol. 23 pp. 1 Geiger H and Scheel K (eds) 1st edition (Springer-Verlag, Berlin)
- [34] Razavy, M. (1967). Quantum-Mechanical time operator, *Am J Phys*, vol. 35, pp. 955.
- [35] Razavy, M. (1971), Time of arrival operator, *Can J Phys*, vol. 49, pp. 3075.
- [36] Rovelli, C (1990), *Phys Rev D*, vol. 42, pp. 2638
- [37] Rovelli, C (1991), *Phys Rev D*, vol. 43, pp. 442
- [38] Sala, R, Brouard, S & Muga, JG (1993) *J Chem Phys*, vol. 99, pp. 2708
- [39] Sala, R and Muga, JG (1994) *Phys Lett A* vol. 192, pp. 180.
- [40] Torres-Vega, G and Frederick, JH (1990) *J Chem Phys* vol. 93, pp. 8862.
- [41] Torres-Vega, G and Frederick, JH (1991) *Phys Rev Lett* vol. 67, pp. 2601.
- [42] Torres-Vega, G (2007) *Phys Rev A*, vol. 76, pp- 032105
- [43] Torres-Vega, G (2007) *Phys Rev A*, vol. 75, pp. 032112
- [44] Torres-Vega, G (2009) *J Phys A: Math Theor*, vol. 42, pp. 465307
- [45] Torres-Vega, G (2007) *Phys Lett A*, vol. 369, pp. 384
- [46] Wigner, E. (1932), *Phys Rev A*, vol. 40, pp. 749.
- [47] Wigner, E. P. (1972), *Aspects of Quantum Theory*, edited by A. Salam and E. P. Wigner (Cambridge, London) pp. 237.

Anisotropic Kepler Problem and Critical Level Statistics

Kazuhiro Kubo and Tokuzo Shimada

*Department of Physics, School of Science and Technology, Meiji University
Japan*

1. Introduction

The subject of this chapter is quantum chaos (QC), in particular, the QC that occurs in the Anisotropic Kepler Problem (AKP). In QC, one studies a quantum system whose classical counterpart is chaotic, and one investigates how the chaotic property in the classical theory shows up its imprints in the quantum theory. To elucidate this quantum-classical correspondence is the first mission of the quantum chaos study.

With the advent of nanophysics techniques, QC has become very important concern also at the experimental side; for pioneering works, we refer to conductance fluctuations in quantum dot (Marcus et. al., 1992), magnetoresistance on a superlattice of antidots (Weiss et al., 1991), a cold-atom realization of the kicked top (Chaudhury et al., 2009).

Also for an interesting experimental observation of quantum scars of classical orbits (Heller, 1984; 1989), we refer to (Stein & Stöckmann, 1992).

Furthermore, quantum chaos study has been developed under far-reaching mutual influences with related areas. In order to explain where our study in AKP stands, let us briefly review a few aspects of quantum chaos study.

Let us first consider the random matrix theory (RMT) (Mehta, 2004). It is proposed by (Wigner, 1951) to predict the universal spectral property of complex nucleus, and the mathematical basement is set by (Dyson, 1962), (Dyson & Mehta, 1963) and (Mehta & Dyson, 1963). In RMT, the hamiltonian of the physical system is described by a random matrix in the three basic ensembles. This implies that the intrinsic quantum property of the physical system is determined by the time reversal symmetry and internal symmetry only, and does not depend on the details of the system hamiltonian. If the time-reversal by the operator T is broken in a system, the relevant ensemble is gaussian random ensemble of hermite matrices for the hamiltonian, admitting the invariance of the hamiltonian under the unitary transformation (GUE), with Dyson parameter $\beta = 2$. If the T invariance holds with $T^2 = 1$, it is gaussian orthogonal ensemble (GOE) of real symmetric matrices with $\beta = 1$, while with $T^2 = -1$, it is gaussian symplectic ensemble (GSE) of quaternion selfdual matrices with $\beta = 4$. It is conjectured by (Bohigas et al., 1984) that, irrespective to the details of the system hamiltonian, the stochastic spectral property of energy levels of an physical system (including AKP) is uniquely described by the relevant RMT ensemble chosen by the above symmetry property

only, provided that the quantum system is in the ergodic regime (BGS conjecture).¹ This conjecture² most remarkably asserts universality classes in the whole lots of quantum chaos systems, and has been successful in great many physical systems³. Now, let us mention a famous, though ever charming episode; a mathematician Montgomery was introduced to Dyson at a tea time and explained his result on the spacing distribution of the non-trivial zeros of Riemann zeta function. Then, Dyson immediately told that it is just what he knows, the $P(s)$ of GUE! Of course, one should also mention that the Gutzwiller trace formula that enumerates the semi-classically quantum Green function of a classically chaotic system from unstable periodic orbits has so close intriguing correspondence with the trace formula of the Riemann zeta function (Bohigas, 2005). A deep correspondence between the Riemann zeta function and the random matrix theory is shown by the agreement between the Conrey-Ghosh conjecture on the $2k$ -th continuous moment of $\zeta(1/2 + it)$ and Keating-Snaith random matrix calculation. One of the most flourishing areas in physics is Anderson localization (Evers & Mirlin, 2008) which is only understandable as a quantum phenomena from the interfering amplitudes at the metal and insulator transition point. The critical statistics is a target of critical random matrix theories. So much for general review and let us turn to AKP.

In this chapter, we calculate the energy level statistics of AKP, and find that it is described well (over a finite range of mass anisotropy) by the critical random matrix model devised by (García-García & Verbaarschot, 2003) that is also related to the critical level statistics in the Anderson localization. We also investigate the systematic change of the AKP wave functions with the mass anisotropy. In the Anderson localization, the theory predicts that at the mobility edge, the wave function is multi-fractal, and the level statistics indicator $\Sigma^2(L)$ should show a linear rise for large L that is also observed by our data. In this way, our study may give a support to the recent notion *Anderson localization in quantum chaos* proposed by (García-García, 2007; García-García & Wang, 2008).

The AKP is a system of an electron bound to a proton, just like a hydrogen atom, but the electron has an anisotropic mass. This system is experimentally realized by an electron in a doped semiconductor. Gutzwiller, who made the periodic orbit theory by his semi-classical trace formula, chose often AKP for a nice testing ground of QC (Gutzwiller, 1971; 1977; 1980; 1981; 1982; 1990). In fact, when mass anisotropy is not present, the system is the hydrogen atom (the Kepler problem) that is one of the most well-studied integrable quantum system. By varying the mass anisotropy parameter, the classical system changes the strength of randomness. It is known that the AKP is not KAM system (García-García & Verbaarschot, 2003; Wintgen & Marxer, 1988) that means that the classical phase space, when the mass anisotropy is present, is *not* a mixture of integrable regions (tori) and ergodic regions. Instead, with the increase of the anisotropy, the system changes its classical phase space structure due to the gradual collapse of tori, via the structure filled by cantori (Zaslavsky et al., 1991) (stochastic web of chaos), finally to that filled by isolated unstable periodic orbits. Thus, AKP is really a nice testing ground that gives us the opportunity to investigate how systematically,

¹ The ergodic regime is defined by as the region with $E_c \gg \Delta$ where E_c is the Thouless energy $E_c = \hbar D/L^2$ (D is the diffusion constant and L is the system size) and Δ is the mean level spacing.

² Recently, a generating function described by a set of periodic orbits is shown, in the semi-classical limit, equivalent to the Feynman diagrams for the kernel in the random matrix theory (Heusler et al., 2007). This clarifies the way the random matrix theory describes the quantum chaos system in the semi-classical limit.

³ More detailed universality classification is given by (Zirnbauer, 1996).

along with increasing anisotropy, the quantum feature changes reflecting the change in the classical phase space structure. Any periodic orbits in AKP in the chaotic regime can be uniquely coded by its own Bernoulli sequences and furthermore Gutzwiller found an amazing approximate formula that gives the action of a periodic orbit from its Bernoulli sequences. In this chapter we aim to view various faces of QC from AKP taking the above mentioned advantages of AKP.

In section 2, we first calculate the energy levels of AKP at various anisotropy following the method developed and first applied to AKP by (Wintgen et al., 1987). In this method, there is a particular parameter ϵ (see (6)) and how to choose it at given anisotropy is crucial to guarantee the accuracy of the levels. We use the Sturmian basis just as in (Wintgen et al., 1987) and we present a couple of simple rules to choose the parameter at a given anisotropy. Also, we set up another formulation based on the harmonic oscillator basis. This provides us with a useful check of our results and, in addition, serves as an efficient method for calculating Husimi function that is an important measure to explore the quantum and classical correspondence.

In section 3, we investigate the level statistics in AKP. There is a concrete result by (Wintgen & Marxer, 1988) for the anisotropy parameter $\gamma = 0.8$ (only), but, in order to investigate the quantum statistics change according to the variation of γ , we definitely need reliable eigenvalue set at various anisotropy too. This is why we have performed the eigenvalue analysis from scratch as described in section 2. We now show for the first time how the number variance and the spectral rigidity change their feature with the variation of mass anisotropy in AKP. The AKP is a system that preserves the time reversal invariance with $T^2 = 1$ and hence its level statistics is expected to be described by GOE in the ergodic region ($\gamma \ll 1$), while in the vicinity of Kepler limit ($\gamma = 1$), it should be Poissonian. We are interested in the physics in the intermediate range. (García-García & Verbaarschot, 2003) showed that the level statistics of AKP at one particular anisotropy is successfully explained by a critical random matrix theory that has one parameter h (temperature in an equivalent model), using the eigenvalue set at $\gamma = 0.8$ given by Wintgen only available at that time, provided that h is suitably chosen. We show that the AKP level statistics can be well described by their critical random matrix theory in a finite range of γ in the intermediate region and show that there is a smooth relation between the parameter h and the anisotropy γ ($h \propto e^{7.2\gamma}$).

In section 4, we now turn our attention to various interesting features of wave functions of AKP. We discuss firstly the nodal line systematics. Then we investigate the probability densities and find salient scars of periodic orbits. This observation is strengthened by the subsequent study of Husimi functions of AKP calculated by the method developed in subsection 4.3.

In section 5, we conclude after a briefly discussion on the future outlook of our work, especially, on the possibility to consider quantum chaos in AKP in the context of Anderson transition

2. Non-perturbative matrix method for the evaluation of quantum energy levels

2.1 WMB method

First we recapitulate the WMB method in the context of AKP (Wintgen et al., 1987; Wintgen & Marxer, 1988) with the electron mass tensor $\text{diag}(m_1, m_1, m_2)$ when diagonalized and mass

anisotropy parameter is $\gamma = m_1/m_2 < 1$.⁴

Introducing appropriate dimensionless coordinates (x, y, z) and momenta (p_x, p_y, p_z) , the AKP hamiltonian is

$$\hat{H} = - \left(\frac{\partial^2}{\partial x^2} + \frac{\partial^2}{\partial y^2} + \gamma \frac{\partial^2}{\partial z^2} \right) - \frac{2}{r} \quad (1)$$

$$= -\Delta^{(3)} - \frac{2}{r} + (1 - \gamma) \frac{\partial^2}{\partial z^2} \quad (2)$$

in the units $\hbar^2 K/m_1 e^2$, $m_1 e^4/2\hbar^2 K^2$, $2\hbar^3 K^2/m_1 e^4$ for length, energy, time, respectively (K is the dielectric constant). One uses Sturmian basis $\{|n\ell m\rangle\}$

$$\langle \vec{r} | n\ell m \rangle = \frac{1}{r} \sqrt{\frac{n!}{(2\ell+n+1)!}} e^{-\frac{\lambda r}{2}} (\lambda r)^{\ell+1} L_n^{2\ell+1}(\lambda r) Y_{\ell m}(\theta, \varphi). \quad (3)$$

Here n , ℓ , m are radial, azimuthal, magnetic quantum numbers respectively and they are related to the principle quantum number n_p by $n_p = n + \ell + 1$. The parameter λ is introduced for the scaling of r . (In the left hand side the dependence on λ is suppressed for simplicity). Note for the eigen function with n_p in the Kepler problem ($\gamma = 1$), $\lambda = 2/n_p$. In the Sturmian basis the Schrödinger equation of the AKP becomes a matrix equation:

$$\left[-\lambda \overleftrightarrow{\Delta}^{(3)} + (1 - \gamma) \lambda \overleftrightarrow{\partial^2/\partial z^2} - 2 \overleftrightarrow{(1/r)} \right] \Psi = (E/\lambda) \overleftrightarrow{\text{Id}} \Psi \quad (4)$$

where the eigenvector Ψ is Col. $(\langle n\ell m | \Psi \rangle)$, and the matrix elements are respectively

$$\begin{aligned} \langle n' \ell' m' | \overleftrightarrow{\text{Id}} | n\ell m \rangle &= \delta_{\ell' \ell} \delta_{m' m} [2(n + \ell + 1) \delta_{n' n} - \sqrt{(n+1)(2\ell+n+2)} \delta_{n' n+1}], \\ \langle n' \ell' m' | \overleftrightarrow{\Delta}^{(3)} | n\ell m \rangle &= (-1)^{n+n'+1} \frac{1}{4} \langle n' \ell' m' | \overleftrightarrow{\text{Id}} | n\ell m \rangle, \\ \langle n' \ell' m' | \overleftrightarrow{1/r} | n\ell m \rangle &= \delta_{n' n} \delta_{\ell' \ell} \delta_{m' m}. \end{aligned}$$

(The ∂^2 term is somewhat complicated and we refer the reader to (Wintgen et al., 1987)). Noting that the Coulombic interaction term is diagonal, while $\overleftrightarrow{\text{Id}}$ is not, one exchanges them between right and left to obtain the standard eigenvalue problem. Dividing the whole equation by λ one obtains

$$\overleftrightarrow{M} \Psi \equiv \left[-\overleftrightarrow{\Delta}^{(3)} + (1 - \gamma) \overleftrightarrow{\partial^2/\partial z^2} - \epsilon \overleftrightarrow{\text{Id}} \right] \Psi = (2/\lambda) \Psi. \quad (5)$$

Note that E/λ in the right-hand side of (4) is now (after divided by λ) changed into a parameter ϵ in the left-hand side of (5), namely

$$E/\lambda^2 \Rightarrow \epsilon. \quad (6)$$

This ϵ should be fixed at some constant value in the diagonalization of (5). This fixing is an extremely clever way in WMB. We will explain this point shortly below.

⁴ For ordinary Kepler problem γ is unity; for silicon $\gamma = 0.2079$ and for germanium $\gamma = 0.05134$.

The 'hamiltonian' matrix \overleftrightarrow{M} is symmetric and block diagonal; nonvanishing elements are those with $\ell' = \ell + 2$ or ℓ , and due to the rotational symmetry about z-axis $m' = m$. Therefore one can organize \overleftrightarrow{M} as a banded and sparse matrix. By solving (5) for the eigenvalues $\Lambda_i \equiv 2/\lambda_i$ the energy levels are in turn determined by $E_i = \epsilon\lambda_i^2$. This is the WMB method. In this scheme (5), the eigen function $\langle \vec{r} | \Psi_i \rangle$ of the i -th level E_i is calculated from the eigen vector Ψ_i using the Sturmian basis with parameter $\lambda_i = (E_i/\epsilon)^{1/2}$. To be explicit one calculates

$$\langle \vec{r} | \Psi_i \rangle = \sum_{n,\ell,m} \langle \vec{r} | n\ell m; \lambda_i \rangle \langle n\ell m; \lambda_i | \Psi_i \rangle. \quad (7)$$

This is in a sharp contrast to (4) where eigenstates of all energy levels must be calculated with a uniquely chosen λ . With the flexibility of *optimizing* λ_i for each Ψ_i , WMB method (5) is by far superior to (4). For instance, if $\gamma \approx 1$, $\epsilon \approx -1/4$ is a good choice since at $\epsilon = -1/4$ the Sturmian basis is already the proper basis for the first order perturbation theory for AKP in $1 - \gamma$.⁵ In fact we can accommodate various γ by adjusting ϵ properly. Supposing that we choose another value for the parameter ϵ of the matrix \overleftrightarrow{M} , the eigenvalues Λ_i s will be accordingly changed, but the physical energies E_i should be kept unchanged. However in practice we cannot help using a truncated basis. We discuss how to accommodate this subtle problem by adjusting ϵ shortly below.

Hereafter we focus our attention to the $m = 0$ sector that is related to the 2-dimensional classical AKP. Also for definiteness we consider the case of even ℓ case. With these constraints the matrix \overleftrightarrow{M} to diagonalize is $N \times N$ with $N = (N_p + 1)^2/4$ where N_p is the maximal principal quantum number of the Sturmian basis $\{|n\ell m\rangle\}$, i.e. $n_p = n + \ell + 1 \leq N_p$, ($\ell \leq n_p - 1$).

We present in Fig. 1 the energy levels of $m = 0$ sector obtained by diagonalizing the 'hamiltonian' \overleftrightarrow{M} in (5) with $N = 7921$ ($N_p = 177$). The levels are plotted as functions of the scaling parameter ϵ (see (5)) for typical values of anisotropy parameter γ , after proper stretch (Bohigas, 2005) using Thomas-Fermi approximation $N(E)$ for the stair case function of AKP (Wintgen & Marxer, 1988)

$$N(E) \equiv \int_{-\infty}^E dE' \rho(E') \approx -\frac{1}{4\sqrt{\gamma E}} \quad (8)$$

where $\rho(E) \equiv \sum_i \delta(E - E_i)$ is the level density. Given $N(E)$, the stretched energy levels f_i are given by inversion (unfolding map (Bohigas & Giannoni, 1984));

$$f_i = N(E_i), \quad i = 1, \dots, N \quad (9)$$

and the average energy spacing $\langle f_{i+1} - f_i \rangle = 1$. The levels must be independent from the scaling parameter ϵ (level curves must be *horizontal*) in so far as the matrix formalism works properly. (Recall that the WMB method is not a perturbation theory; it should yield exact results if the matrix size N is infinity at any choice of ϵ .) However, at a glance, one finds that the curves are under all over systematic distortion induced by truncating the matrix size. In order to accommodate this, one should select the part of calculated energy levels that satisfy

⁵ At $\epsilon = -1/4$ and $\gamma = 1$, $\lambda_i = (E_i/\epsilon)^{1/2} = 2/n_p$ so that $L_n^{2\ell+1}(\lambda_i r) = L_n^{2\ell+1}((2/n_p)r)$ is the main radial part of the eigenfunction of the Kepler problem.

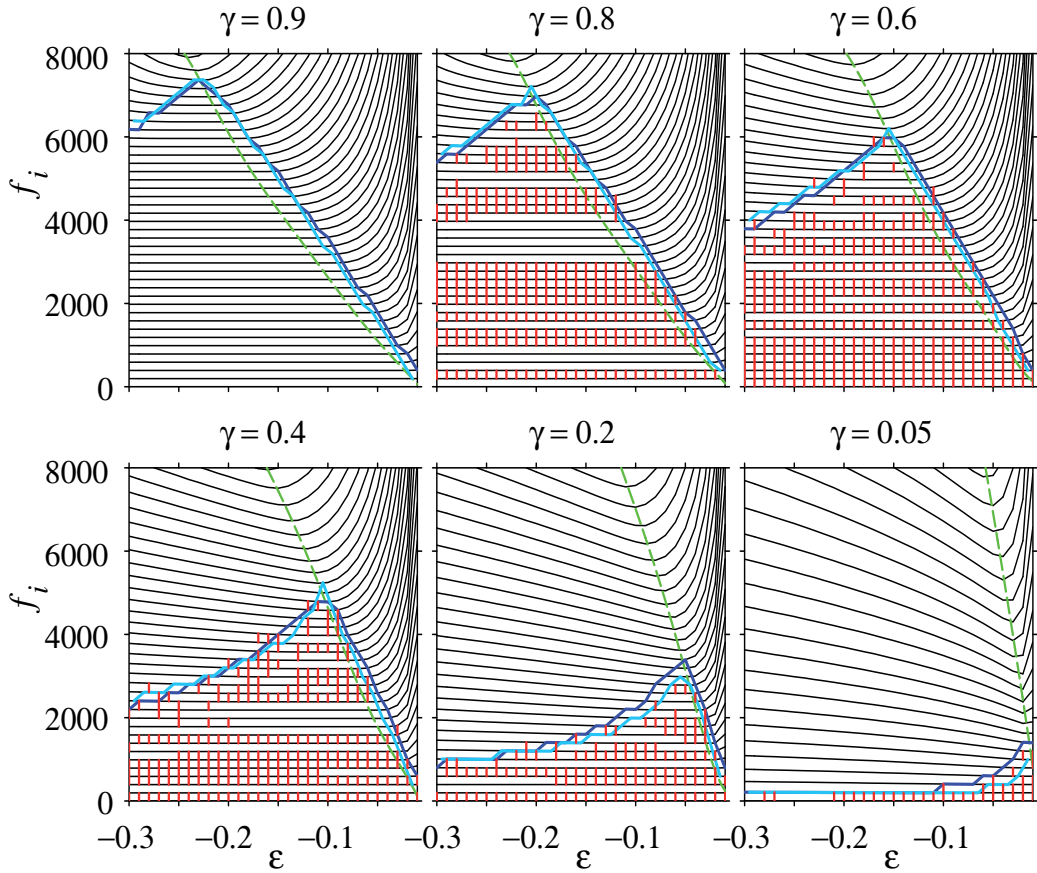

Fig. 1. Stretched level curves f_i at every 200 level along with the good domain on the $f_i - \epsilon$ plane. $N_p = 177$, $N = 7921$, $\ell = \text{even}$, $m = 0$. Sky- and dark-blue mountain-like curves account for necessary conditions 1 and 2 respectively and the bulk under the curves satisfies sampling test (e.g. Fig. 2). In order to make curves, diagonalization is performed for each γ and for thirty values of scaling parameter ϵ ranging from -0.3 to -0.01 with increment 0.01 . The green dashed curve connects the minimum point of f_i and hits naturally the peak of the mountain. The level group with level-repulsion property is marked by red; these groups together remarkably overlap the domain for any γ (except the one $\gamma = 0.9 > 8/9$). For discussion on this, see subsection 3.1.

the following condition:

Condition 1: The level curves must be all horizontal. This is a necessary condition. In each diagram for respective γ the region under the (sky-blue) mountain-shaped curve is the *good ϵ -scaling region*.

One must consider one more condition. Recall that the spectrum (E_i) is stretched by Thomas-Fermi formula. If this procedure is valid the resultant spectrum (f_i) must satisfy $\delta f_i \approx 1$ apart from local fluctuations. Let us put this into a quantitative form;

Condition 2: The $|\langle \delta f_i \rangle_n - 1| \lesssim 0.05$.⁶ Here n labels one of the 40 groups that the whole levels are divided into by ascending order. The region under the (dark-blue) mountain-shaped curve is the *successfully stretched region*. One observes a good overall agreement between two-types of regions, which gives a strong support for the celebrated WMB method. The bulk under the mountain-shaped curves in the $f_i - \epsilon$ plane in Fig. 1 is a candidate region for the study of level statistics satisfying both of necessary conditions. Let us call it the *good domain*.

Now we have to proceed a step forward; the energy levels are under subtle fluctuation and we must examine the level statistics (for each anisotropy γ) in order to understand the quantum AKP theory. Does the good domain maintain a unique level statistics?

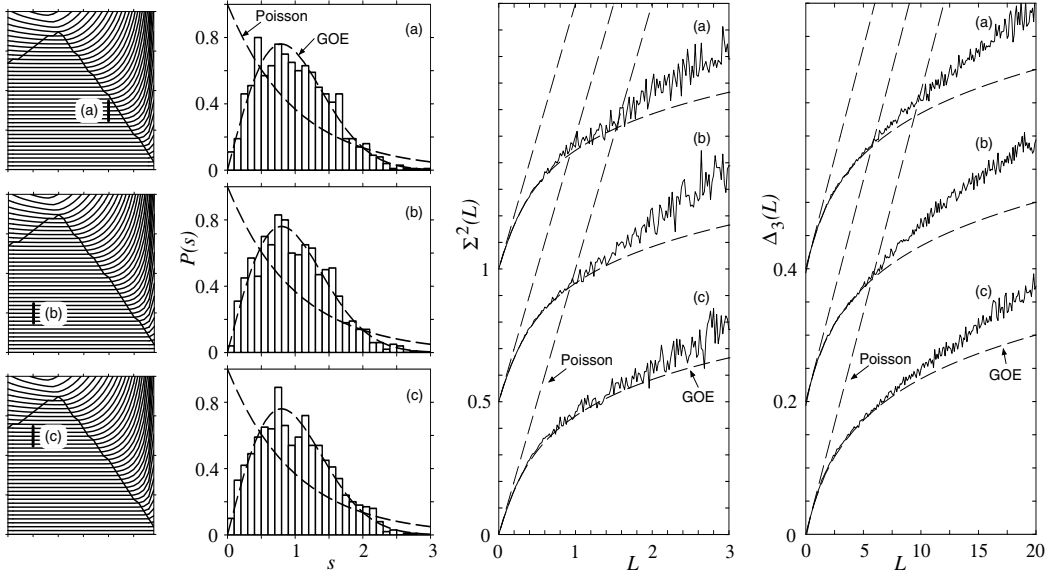

Fig. 2. Comparison of the level statistics $P(s)$, $\Sigma^2(L)$, $\Delta_3(L)$ sampled at regions (a), (b), (c). Note that graphs for the latter two statistics are properly shifted to avoid their overlap. The vertical axis is for (c).

Fig. 2 exhibits a sample of test. Here we have selected three regions (a, b, c), each consists of a thousand levels (5 groups) at a given ϵ . The comparison of the level statistics (Dyson, 1962; Dyson & Mehta, 1963; Mehta, 2004) in this figure succinctly shows that there is no sizable difference of the statistics with respect to any one of the three statistical characteristics; the spacing distribution $P(s)$, the number variance $\Sigma_2(L)$ and the spectral rigidity $\Delta_3(L)$. (For details of these quantities, see later discussion.) Repeating this test all over the good domain, we have checked that any region in the good main is equally satisfactory for the level statistics. Now we are in the position to propose a prescription to determine the proper ϵ for the eigenvalue analysis on the WMB method;

⁶ We checked that the accepted region does not vary more than one group in height (200 levels) even if the bound is replaced by 0.1. On the other hand if the bound is decreased the region becomes sparse because of the tail of the $P(s)$ distribution. The averaging over the group acts to suppress this.

Prescription for ϵ : Choose the ϵ value that gives the maximum height of the good domain; then one can determine the largest number of levels at the given γ and at the given matrix size N . This ϵ is the best. We denote it ϵ^ .*

2.2 Regularities regarding the best choice for ϵ

We have found the following empirical regularities regarding ϵ^* .

- (i) Fig. 3 shows the relationship between γ and ϵ^* . Data points clearly follow a linear line described very well by

$$\epsilon^* \simeq (-1/4)\gamma. \quad (10)$$

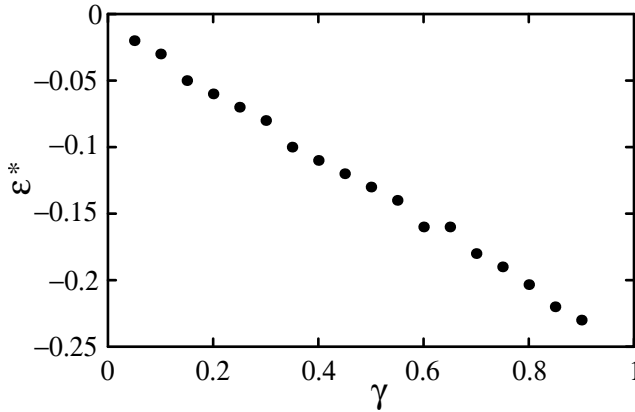

Fig. 3. The ϵ^* vs. γ .

- (ii) Consider the ratio R_{eff} of the number of eigenvalues that satisfy conditions (1) and (2) to the number of whole levels N at ϵ^* . This is an indicator that tells us how much levels among all are really usable for the investigation of quantum level statistics. Fig. 4 shows plotted R_{eff} as a function of γ . We find it is described very well by

$$R_{eff} \simeq c\sqrt{\gamma}. \quad (11)$$

Here $c = 1$ with an error of only one per cent.

We have checked that these observations do not depend on the matrix size N . For instance, the small set $N = 1444$ ($N_p = 75$) shows the same features with the large set $N = 7921$ ($N_p = 177$). This independence assures the following planning of the AKP diagonalization using the WMB method. Using (10) as a rule of thumb, we can first easily estimate the appropriate ϵ^* that is appropriate for a given anisotropy γ . Then using (11), we can estimate the necessary matrix size N for obtaining desired number of energy levels. For instance, if one wants to examine the germanium (silicon) levels with $\gamma \approx 0.05$ (0.2), then $R_{eff} = 0.23$ (0.46) at $\epsilon^* = -0.01$ (-0.05). Then, to obtain first say 2000 reliable levels in the $\ell = \text{even}$ and $m = 0$ sector, one has to choose $N \approx 8800$ (4400). On the other hand, for $\gamma = 0.8$, the appropriate ϵ^* now becomes -0.2 and

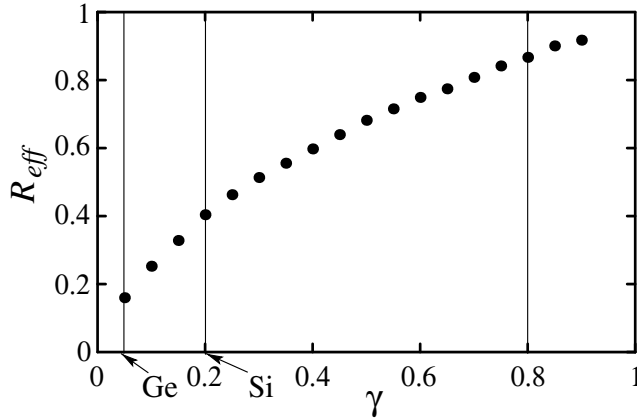

Fig. 4. Ratio of reliable levels vs. γ .

$R_{eff} = 0.9$.⁷ Regularities (10) and (11) are remarkably simple. It is obvious that the ϵ^* curve in Fig. 3 starts from $\epsilon = -1/4$ at the Kepler limit ($\gamma = 1$) because, as we discussed below (7), the Sturmian basis is already the proper basis for the first order perturbation theory for AKP. This curve presumably represents the effect of truncating the basis in the WMB diagonalization. (10) and (11) are tantalizing.

2.3 Application of harmonic oscillator function basis to AKP

Harmonic oscillator function basis is quite useful for quantum chaos study through Husimi function (Husimi, 1940) and we discuss here the application of it to AKP. The formulation is almost parallel to that in subsection 2.1; main difference stems in the interaction terms. Let us introduce the semi-parabolic coordinates μ, ν, ϕ by

$$\mu\nu = \rho = \sqrt{x^2 + y^2}, \quad \frac{1}{2}(\mu^2 - \nu^2) = z, \quad \phi = \tan^{-1}\left(\frac{y}{x}\right). \quad (12)$$

The AKP Schrödinger equation in terms of semi-parabolic coordinates is

$$\left[-\frac{1}{2(\mu^2 + \nu^2)} \left(\Delta_\mu^{(2)} + \Delta_\nu^{(2)} \right) + \frac{1-\gamma}{2} \frac{\partial^2}{\partial z^2} - \frac{2}{\mu^2 + \nu^2} \right] |\Psi\rangle = E|\Psi\rangle. \quad (13)$$

⁷ The level statistics of AKP at $\gamma = 0.8$ were studied in the seminal paper (Wintgen & Marxer, 1988) but the choice of ϵ was not written there regrettably. Also no other data were published for other γ . In an earlier article (Wintgen et al., 1987) (the paper of WMB method), the low lying levels of silicon ($\gamma = 0.2079$) and germanium ($\gamma = 0.05134$) had been presented with the explicit statement of $\epsilon = -0.01$ for both cases. This led us to some confusion at the early stage of this work, because, for $\gamma = 0.8$, the proper choice is $\epsilon \approx -0.2$ much smaller than $\epsilon = -0.01$. Our level statistics results for $\gamma = 0.8$ agree with those in (Wintgen & Marxer, 1988) within errors; therefore we believe that ϵ was adjusted properly in (Wintgen & Marxer, 1988). We add that the best choice for Silicon is $\epsilon = -0.05$ rather than $\epsilon = -0.01$; this enhances R_{eff} approximately by factor 3. At these circumstances we revisited the whole level calculation and construct Fig. 1 (plus a dozen diagrams for other anisotropy).

Multiplying by $\mu^2 + \nu^2$ and exchanging the Coulombic interaction term and the E term between the right and left hand sides, one obtains

$$\left[-\frac{1}{2} \left(\Delta_{\mu}^{(2)} + \Delta_{\nu}^{(2)} \right) + |E|(\mu^2 + \nu^2) + \frac{1-\gamma}{2}(\mu^2 + \nu^2) \frac{\partial^2}{\partial z^2} \right] |\Psi\rangle = 2|\Psi\rangle. \quad (14)$$

Thanks to the semi-parabolic coordinates, the Coulombic singularity has removed (Kustaanheimo & Stiefel, 1965) (for $\gamma = 1$).

One has now two of two-dimensional harmonic oscillators coupled by an interaction term $(\mu^2 + \nu^2)\partial^2/\partial z^2$ introduced by the mass anisotropy in the original problem. Let us call the oscillators as μ - and ν - oscillators respectively. The proper basis for each oscillator is the harmonic oscillator basis and for two of them one uses tensor product of these bases. The μ - harmonic basis $\{|j, m\rangle\}$ is defined as eigenstates of the Schrödinger equation for the two-dimensional harmonic oscillator

$$\left(-\frac{1}{2}\Delta_{\mu}^{(2)} + \frac{1}{2}\mu^2 \right) |j, m\rangle = (2j + 1 + |m|) |j, m\rangle \quad (15)$$

and the polar-coordinate representation of normalized $|j, m\rangle$ is given by

$$\begin{aligned} \langle \mu, \phi_{\mu} | j, m \rangle &\equiv \psi_{jm}(\mu, \phi_{\mu}) = \frac{1}{\sqrt{\pi}} \sqrt{\frac{j!}{(j+|m|)!}} e^{im\phi_{\mu}} L_j^{|m|}(\mu^2) e^{-\frac{\mu^2}{2}} \mu^{|m|}, \\ \int_0^{\infty} \mu d\mu \int_0^{2\pi} d\phi_{\mu} \langle j', m' | \mu, \phi_{\mu} \rangle \langle \mu, \phi_{\mu} | j, m \rangle &= \delta_{jj'} \delta_{mm'}. \end{aligned} \quad (16)$$

For the $m = 0$ sector of AKP, one should set $m_{\mu} = m_{\nu} = 0$ and one uses tensor basis

$$\begin{aligned} |i, j\rangle &\equiv |i, m_{\mu} = 0\rangle \otimes |j, m_{\nu} = 0\rangle, \\ |\mu, \nu\rangle &\equiv |\mu, \phi_{\mu} = 0\rangle \otimes |\nu, \phi_{\nu} = 0\rangle, \\ \langle \mu, \nu | i, j \rangle &\equiv \psi_{i0}(\mu) \psi_{j0}(\nu) = \frac{1}{\pi} L_i(\mu^2) L_j(\nu^2) e^{-\frac{\mu^2 + \nu^2}{2}}. \end{aligned} \quad (17)$$

In order to use WMB method let us modify basis $\{|i, j\rangle\}$ by introducing a scaling parameter κ . One replaces $\mu^2/2$ and $|j, m\rangle$ by $\kappa^2\mu^2/2$ and $|j, m, \kappa\rangle$. This leads to a modified basis $\{|i, j, \kappa\rangle\}$ with

$$\langle \mu, \nu | i, j, \kappa \rangle = \frac{\kappa}{\pi} L_i(\kappa\mu^2) L_j(\kappa\nu^2) e^{-\kappa\frac{\mu^2 + \nu^2}{2}}. \quad (18)$$

With this basis (14) is written as the matrix equation

$$\begin{aligned} \sum_{i'', j''} \langle i', j'; \kappa | \left\{ -\frac{1}{2} \left(\Delta_{\mu(\text{rad})}^{(2)} + \Delta_{\nu(\text{rad})}^{(2)} \right) + |E|(\mu^2 + \nu^2) + \frac{1-\gamma}{2}(\mu^2 + \nu^2) \frac{\partial^2}{\partial z^2} \right\} \\ |i'', j''; \kappa\rangle \langle i'', j''; \kappa | \Psi \rangle = 2 \langle i', j'; \kappa | \Psi \rangle. \end{aligned} \quad (19)$$

One finds

$$\langle i', j'; \kappa | \mu^2 | i, j, \kappa \rangle = \frac{1}{\kappa^3} \langle i', j'; 1 | \mu^2 | i, j; 1 \rangle \quad (20)$$

and corresponding scaling property of other terms are κ^{-2} , κ^{-1} , κ^{-1} for 1 , $\Delta_{\mu(\text{rad})}^{(2)}$, $(\mu^2 + \nu^2)\partial^2/\partial z^2$ respectively. Using this scaling, (19) is transformed into

$$\sum_{i'', j''} \langle i', j'; 1 | \left\{ -\frac{1}{2} \left(\Delta_{\mu(\text{rad})}^{(2)} + \Delta_{\nu(\text{rad})}^{(2)} \right) + \frac{|E|}{\kappa^2} (\mu^2 + \nu^2) + \frac{1-\gamma}{2} (\mu^2 + \nu^2) \frac{\partial^2}{\partial z^2} \right\} | i'', j''; 1 \rangle \times \langle i'', j''; \kappa | \Psi \rangle = \frac{2}{\kappa} \langle i', j'; \kappa | \Psi \rangle. \quad (21)$$

The matrix elements for the first two terms are

$$\begin{aligned} \langle i', j'; 1 | (\mu^2 + \nu^2) | i, j; 1 \rangle &= \left[(2i+1)\delta_{i'i}\delta_{j'j} - (i+1)\delta_{i'i+1}\delta_{j'j} - i\delta_{i'i-1}\delta_{j'j} \right] + [i \leftrightarrow j], \\ \langle i', j'; 1 | \left(\Delta_{\mu(\text{rad})}^{(2)} + \Delta_{\nu(\text{rad})}^{(2)} \right) | i, j; 1 \rangle &= (-1)^{i'+j'+i+j+1} \langle i', j'; 1 | (\mu^2 + \nu^2) | i, j; 1 \rangle. \end{aligned} \quad (22)$$

Matrix elements of the third term ⁸ needs tedious but straightforward calculation ⁹.

$$\begin{aligned} \frac{1}{4} \mathcal{D} \frac{\partial^2}{\partial z^2} \langle \mu, \nu | i, j \rangle &= \left\{ -\left(\frac{1}{\mathcal{D}^2} + \frac{1}{\mathcal{D}} \right) \left((i-j)(\mu^2 - \nu^2) + 2\mu^2\nu^2 \right) + \frac{\mu^2\nu^2 - 2ij}{\mathcal{D}} + \frac{1}{4}(\mu^2 + \nu^2) \right\} \langle \mu, \nu | i, j \rangle \\ &+ \left[i \left(\frac{\mu^2 - \nu^2}{\mathcal{D}^2} + \frac{2j - \nu^2}{\mathcal{D}} \right) \langle \mu, \nu | i-1, j \rangle \right] + \left[\mu \leftrightarrow \nu, i \leftrightarrow j \right] \\ &- \frac{2ij}{\mathcal{D}} \langle \mu, \nu | i-1, j-1 \rangle, \quad \mathcal{D} \equiv \mu^2 + \nu^2 = 2r \end{aligned}$$

and the necessary integration formula is

$$\int_0^\infty \mu d\mu \int_0^\infty \nu d\nu \frac{\mu^{2b}\nu^{2c}}{(\mu^2 + \nu^2)^a} L_{n'}(\mu^2) L_n(\mu^2) L_{m'}(\nu^2) L_m(\nu^2) e^{-(\mu^2 + \nu^2)}, \quad (23)$$

$(a \in \{0, 1, 2\}, b \in \{0, 1\}, c \in \{0, 1\}).$

The case $a = 0$ is straightforward; for $a = 1, 2$, one uses the integral of the type

$$L_n(\beta x) = \sum_{k=0}^n \binom{n}{k} \beta^k (1-\beta)^{n-k} L_k(x).$$

Now that we have obtained the matrix elements, our procedure goes parallel to that in subsection 2.1. Corresponding to (6) we introduce the parameter

$$\tilde{\epsilon} = 2 \frac{|E|}{\kappa^2}. \quad (24)$$

⁸ For diamagnetic hydrogen case, the corresponding term is $B^2(\mu^4\nu^2 + \mu^2\nu^4)$ (Müller & Wintgen, 1994) and easier to calculate.

⁹ It can be useful to formulate with the creation and annihilation operators. Details will be discussed in our forthcoming paper.

Then one can solve (21) as the standard eigenvalue problem and can obtain eigenvalues $\Lambda_n = 2/\kappa_n$. Energy levels are determined by

$$E_n = -\frac{\kappa_n^2}{2}\tilde{\epsilon} = -\frac{2}{\Lambda_n^2}\tilde{\epsilon}. \quad (25)$$

It is found numerically that the best value of $\tilde{\epsilon}$ satisfies

$$\tilde{\epsilon}^* = \gamma \quad (26)$$

which is similar to (10). Finally we should add that we have found precise agreement between our calculations by the Sturmian basis and by the harmonic oscillator basis.¹⁰

3. Quantum level statistics in anisotropic kepler problem

3.1 Level repulsion

Let us first look at the nearest neighbor level spacing distribution $P(s)$ that is the probability for the nearest neighbor level appears at the distance $s\Delta$. Here Δ is the mean level spacing and after the stretch (9), $\Delta = 1$ in this subsection. First we recollect the RMT predictions. For γ near 1 the overlap of wave functions are negligible and $P(s)$ is expected to be Poisson. The mean squared deviation (MSD) of level spacings is then unity. On the other hand, for large anisotropy, the wave function overlap is sizable and quantum levels repel each other. Especially at the ergodic limit, the statistics is expected to be Wigner-Dyson(WD) statistics. Since AKP respects time reversal invariance, one expects the limiting level statistics is WD with $\beta = 1$ (GOE). (BGS conjecture). At this limit, the RMT prediction for the MSD of level spacing is as low as $4/\pi - 1 = 0.273 \dots$.

With this theoretical expectation in mind, let us first try a coarse analysis to obtain rough idea on where the level statistics is like WD distribution using data on $P(s)$. As the limiting MSD is 0.273, we set a condition $MSD \lesssim 0.28$. We indicate in Fig. 1 by vertical lines the regions where this condition is met. Here we observe that, except for $\gamma = 0.9$ (the first panel), whole of the region of reliable data (the region under the mountain) remarkably satisfy the condition, while other region does not. This indicates some consistency in our analysis. But, of course, looking only at the second moment is insufficient to tell the real shape of the distribution is like-WD.

Therefore, in order to step forward, we have calculated the $P(s)$ from our data extensively. In Fig. 5, we show real $P(s)$ distribution at $\gamma = 0.9, 0.8, 0.7$ as samples and compare with the prediction at limits (Poisson and GOE). We find that for $\gamma \lesssim 0.7$ the $P(s)$ is WD, and around $\gamma \sim 0.8$ a small deviation from WD starts. (But still satisfies above like-WD criterion). Now the $P(s)$ at $\gamma = 0.9$ is sizeably deviated from WD distribution. This explains why the like-WD criterion is not met at $\gamma = 0.9$. Furthermore, the deviation occurs mainly around $s = 1$ and remarkably the level repulsion still persists ($P(s) \propto s$). From this, it seems that AKP is not a system to have the Berry-Robnik distribution (Berry & Robnik, 1984) in which the $P(0)$ takes finite value depending on the partition of regular and chaotic orbits and rather a system that follows the stochastic approach (Hasegawa et al., 1988; Yukawa & Ishikawa,

¹⁰ For instance, $E_{1800} = -0.00018114433$ and $E_{1800} = -0.00018114418$ for Sturmian and harmonic basis calculation respectively.

1989). The persisting repulsion at the transitive region reminiscent to the fact that, in the Anderson transition, not only in the metallic phase but also at the mobility edge the level repulsion occurs (Fyodorov & Mirlin, 1997). Noting that AKP is not a KAM system, it would be interesting to look at the change of the behavior of $P(s)$ near $\gamma = 1$ though it is difficult to apply proper stretch there.

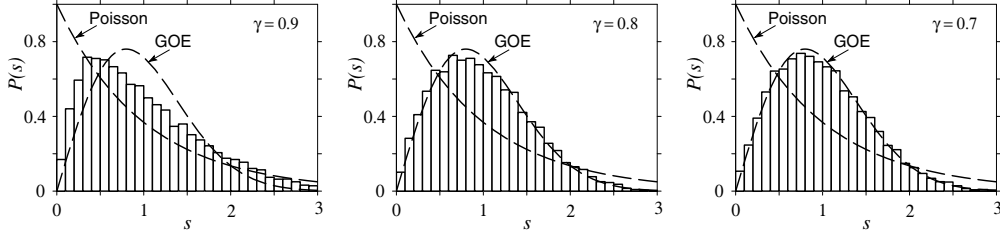

Fig. 5. Nearest neighbor level spacing distribution of AKP for $\gamma = 0.9, 0.8, 0.7$.

3.2 Level statistics as seen by $\Sigma^2(L)$ and $\Delta_3(L)$

As further statistical quantities one can consider the number variance $\Sigma^2(L)$ and the spectral rigidity $\Delta_3(L)$. These are both related to the level density-density correlation functions and suitable to the test for the RMT predictions. The number variance is defined as

$$\Sigma^2(L) = \left\langle (\hat{n}(L, E) - L)^2 \right\rangle \quad (27)$$

and the spectral rigidity¹¹ by

$$\Delta_3(L) = \left\langle \frac{1}{L} \min_{\{A, B\}} \int_{-L/2}^{L/2} (\hat{N}(E+x) - Ax - B)^2 dx \right\rangle. \quad (28)$$

Here $\hat{n}(L, E)$ is the number of (unfolded) levels within the band with L around E , $\hat{N}(E)$ is the stair case function, and $\langle \dots \rangle$ implies the spectral average. Because both $\Sigma^2(L)$ and $\Delta_3(L)$ are derived from the two-point correlation functions, they are related by the Pandey relation (Pandey, 1979)

$$\Delta_3(L) = \frac{2}{L^4} \int_0^L (L^3 - 2rL^2 + r^3) \Sigma^2(r) dr. \quad (29)$$

This gives, for the Poisson statistics (independent levels), $\Delta_3(L) = L/15$ from $\Sigma^2(L) = L$. As a map from $\Sigma^2(L)$ to $\Delta_3(L)$, this gives enhanced weight for the low L side of $\Sigma^2(L)$.

In Fig. 6, we present for the first time the $\Sigma^2(L)$ and $\Delta_3(L)$ for various anisotropy ($\gamma = 0.85, 0.8, 0.7$). Prediction by RMT (GOE) is also shown;

$$\Sigma^2(L) = \frac{2}{\pi^2} \left[\log(2\pi L) + \gamma_E + 1 - \frac{\pi^2}{8} \right], \quad (30)$$

$$\Delta_3(L) = \frac{1}{\pi^2} \left[\log(2\pi L) + \gamma_E - \frac{5}{4} - \frac{\pi^2}{8} \right], \quad (31)$$

¹¹ $\Delta_3(L)$ was first introduced in (Dyson & Mehta, 1963) and studied in terms of the periodic orbit theory (Berry, 1985). The useful formulation for the numerical computation is found in (Bohigas & Giannoni, 1984).

for large L and in the small L region we give numerical estimate.

For $\gamma = 0.6$ and lower, the statistics become indistinguishable from the GOE.

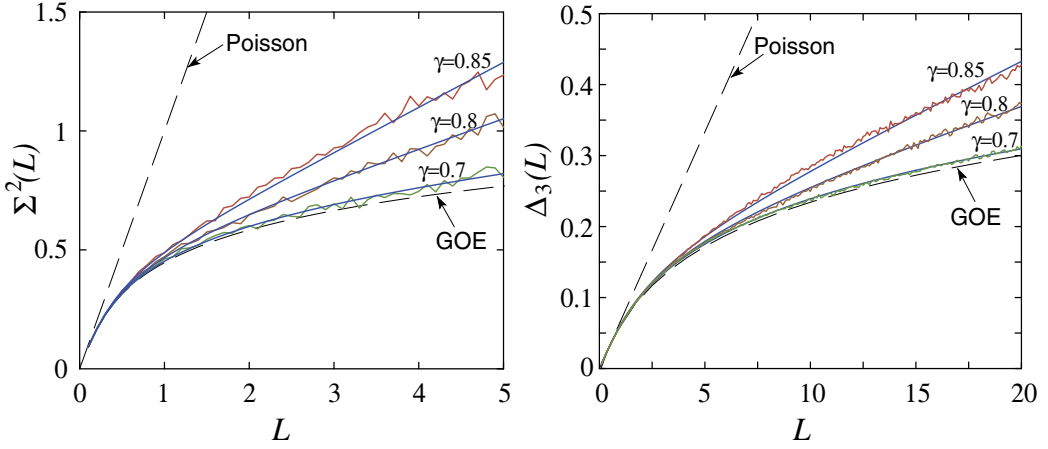

Fig. 6. Number variance $\Sigma^2(L)$ and spectral rigidity $\Delta_3(L)$ of AKP at $\gamma = 0.85, 0.8, 0.7$ calculated from 2501 to 12500 levels with $\ell = \text{even}$, $m = 0$, $N = 19321$ ($N_p = 277$). The solid curves exhibits the prediction by the generalized GOE model (García-García & Verbaarschot, 2003) at $h = 0.160, 0.114, 0.034$ for $\Sigma^2(L)$ and $h = 0.178, 0.128, 0.032$ for $\Delta_3(L)$ respectively.

3.3 Critical random matrix theories

There is an important model by García-García & Verbaarschot (2003) (we call it GV model) of the critical level statistic for the T invariant system. It is an extension of the generalized GUE (Moshe et al., 1994) to generalized GOE. This extension is successfully performed by two threads of ideas; a map to the Calogero-Sutherland (CS) model (Calogero, 1969a;b; 1971; Sutherland, 1971a;b), which avoids the difficult integration over matrices in the GOE case, and the use of Kravtsov-Tsvelik (KT) conjecture for the density-density correlation function of the CS model in the low temperature limit (Kravtsov & Tsvelik, 2000).

The model is defined by the joint probability distribution

$$P(S, b) = \int dM e^{-\frac{1}{2} \text{Tr} S S^T} e^{-\frac{b}{2} \text{Tr} [M, S] [M, S]^T}, \quad (32)$$

where the matrices S and M are both $N \times N$ and real symmetric and orthogonal respectively. This is a one-parameter model; the parameter b interpolating two statistics. At $b \rightarrow 0$, the model becomes GOE ($P(S) \sim e^{-\frac{1}{2} \text{Tr} S S^T}$). At $b \rightarrow \infty$, such S dominate that commute with arbitrary diagonal orthogonal matrices, i.e. the Poisson ensemble. The critical statistics is obtained if b is scaled as $b = h^2 N^2$ for the large N limit.

The joint distribution of the eigenvalues $x \equiv (x_1, x_2, \dots, x_N)$ of S is given by

$$\rho(x) = \Delta(x) \int dM e^{-\frac{2b+1}{2} \text{Tr} S^2 + b \text{Tr} S M S M^T} \quad (33)$$

where $\Delta(x) = \prod_{i < j} (x_i - x_j)$. Now, by considering the propagator of the matrix S in the imaginary time τ (Zirnbauer & Haldane, 1995), one obtains

$$\langle x | e^{-\tau \hat{H}_{CS; \lambda=1}} | x \rangle = C \int dM e^{-\frac{\omega}{2 \sinh \omega \tau} [\text{Tr} S^2 \cosh \omega \tau - \text{Tr} S M S M^T]} \quad (34)$$

where $\hat{H}_{CS; \lambda=1}$ in the left-hand side is the CS hamiltonian¹² with $\lambda = 1$. Therefore, by comparing (33) and (34), one finds that the joint eigenvalue distribution of GV model is given by the diagonal matrix elements of the N -particle density matrix of CS model at an inverse temperature τ given by the identification $\omega / \sinh \omega \tau = 2b$, $\omega \cosh \omega \tau / \sinh \omega \tau = 2b + 1$.

The KT conjecture gives the low temperature limit of connected density-density correlation function of CS model at $\lambda = 1$ as

$$R_{2,c}^T(x, 0) = -(\bar{K}_T(x, 0))^2 - \left(\frac{d}{dx} \bar{K}_T(x, 0) \right) \int_x^\infty \bar{K}_T(t, 0) dt \quad (36)$$

where $\bar{K}_T(x, 0) = T \sin(\pi x) / \sinh(\pi x T)$ is the kernel of CS model for $\lambda = 2$ and $T = \pi h / 2$. (García-García & Verbaarschot, 2003) suggests to replace it by its finite temperature analog (Moshe et al., 1994) and then the unfolded spectral kernel is given by¹³

$$\bar{K}^T(x, 0) = \sqrt{h} \int_0^\infty \frac{\cos(\pi x \sqrt{ht})}{2\sqrt{t}} \frac{1}{1 + z^{-1} e^t} dt. \quad (37)$$

From the density-density correlation function (36) with (37) one can calculate $\Sigma^2(L)$ by

$$\Sigma^2(L) = L + 2 \int_0^{L/\rho(0)} ds (L - s) R_{2,c}^{T=\pi h/2}(s, 0) \quad (38)$$

and the spectral rigidity $\Delta_3(L)$ through the Pandey relation (29). The above summarizes the work by García-García & Verbaarschot (2003).

Now we are in a position to compare their predictions with the AKP data with respect to the variation of γ . We have verified, first of all, the AKP data of $\Sigma^2(L)$ and $\Delta_3(L)$ satisfy the Pandey relation in order to guarantee that AKP levels are normal statistical set (Pandey, 1979). Now in order to test that the GV model can explain $\Sigma^2(L)$ and $\Delta_3(L)$ coherently, we have performed a one parameter fit, at each γ , for the best h that explains $\Sigma^2(L)$ data and $\Delta_3(L)$ data independently. Since the $\Sigma^2(L)$ soon shows large fluctuation for large L , we have limited to $L \lesssim 5$ for the $\Sigma^2(L)$ fit, and used $L \lesssim 20$ for the $\Delta_3(L)$ fit. The level set we used is the largest one that is obtained by the diagonalization of 19321×19321 ($N_p = 277$) hamiltonian matrix (at each γ) and we used the reliable 10^4 levels starting from 2501-th.

The result exhibited in Fig. 7 succinctly shows that the GV model well describes the AKP data in the range of γ from 0.75 up to 0.9. The discrepancy between the $\Sigma^2(L)$ fit and $\Delta_3(L)$ fit is

¹² The CS hamiltonian is

$$\hat{H}_{CS} = - \sum_j \frac{\partial^2}{\partial x_j^2} + \frac{\lambda}{2} \left(\frac{\lambda}{2} - 1 \right) \sum_{i \neq j} \frac{1}{(x_i - x_j)^2} + \frac{\omega^2}{4} \sum_j x_j^2. \quad (35)$$

¹³ A typographical error in equation (30) of García-García & Verbaarschot (2003) is corrected in their arXiv:cond-mat/0204151(version 2) and we have corrected for it in (37).

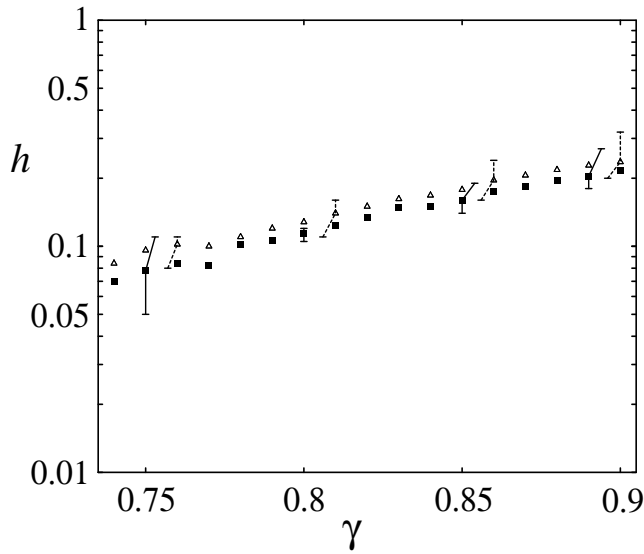

Fig. 7. The parameter h in the critical random matrix model (García-García & Verbaarschot, 2003) as determined by number variance (box with solid error bar) and by spectral rigidity (triangle with dashed error bar).

negligible. The parameter h is related to the temperature T of the CS model as $T = \pi h/2$. We note that the correspondence between h and anisotropy γ is well described by a simple approximation

$$h \propto e^{7.2\gamma}. \quad (39)$$

In the physics of Anderson transition, a finite size scaling analysis turns out vital to scrutinize the phase transition point (García-García & Wang, 2008; Shklovskii et al., 1993). In order to compare with it, we are now trying a similar analysis using our results at various sizes. So much for the eigenvalues. Now let us turn to the wave functions.

4. Wave function features in anisotropic kepler problem

Here we describe three important features of AKP wave functions. Firstly, we show the systematic increase of the complexity of wave function nodal lines ($\{\mathbf{r}|\Psi_i(\mathbf{r}) = 0\}$) with the increase of the anisotropy $1 - \gamma$. Secondly, the probability density $|\Psi_i(\mathbf{r})|^2$ is investigated and it is shown that salient scars of periodic orbits are observed. Thirdly, we describe the method to evaluate Husimi functions using the basis given in subsection 2.3 and compare the Husimi distributions with the Poincaré section of the above scarring periodic orbits.

4.1 Nodal lines of AKP wave functions

The systematics of nodal lines of the eigenfunction of the laplacian operator has long history. For instance, we can find an amazing example in (Courant&Hilbert, 1953) of a self-avoiding long nodal line of an eigenfunction of a laplacian, that propagates in the whole rectangle only by itself (Fig. 8).

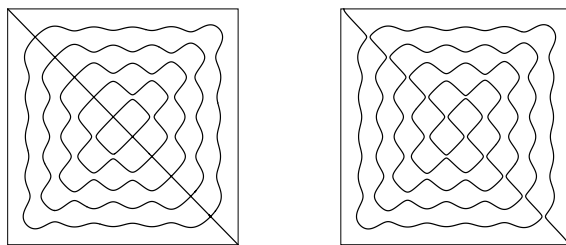

Fig. 8. The nodal line of an eigenfunction $u(x, y) = \sin(2rx) \sin y + \mu \sin x \sin(2ry)$ of an eigenvalue problem $\Delta u + \lambda u = 0$ in the square region $S \equiv [0, \pi]^2$ with Dirichlet boundary condition $u|_{\partial S} = 0$ with eigenvalue $\lambda = 1 + 4r^2$. Left: $\mu = 1$ and right: $\mu = 0.96$. $r = 6$ is chosen to reproduce the figures in (Courant&Hilbert, 1953).

In general, the nodal line for the wave function in the non integrable case is self-avoiding. At the would be crossing, the function must be zero, and also it must be a saddle point. Both conditions can be met only coincidentally. We refer to (Gutzwiller, 1990) for nodal lines. Also we refer to a recent interesting example, the nodal line of the Maass wave form on modular surface $PSL(2, Z) \setminus H$ calculated by (Hejhal & Rackner, 1992) and the increase of the complexity at higher eigenvalues.

In Fig. 9 we exhibit the nodal line of AKP wave function $\Psi_{438}(\mathbf{r})$ at $\gamma = 1, 0.95, 0.8, 0.2$.¹⁴ One observes that even a small anisotropy, the crossings of nodal lines at the integrable limit ($\gamma = 1$) are resolved. With increasing anisotropy, nodal loops are created, and nodal lines increase their complexity. In the ergodic region ($\gamma = 0.2$), nodal lines become very complex. It seems that nodal lines in the large anisotropy region show some fractal structure. (Compare the right magnified diagram with the left one at $\gamma = 0.2$.) We are pursuing this issue introducing manifold with smoothed Coulomb singularity. The relation between the multi-fractality of wave functions (see section 5) is also under survey.

4.2 Large value of wave functions and periodic orbits

Let us try a straight forward comparison between the probability distribution of the AKP electron predicted by the wave function and periodic orbits. We have constructed and scanned $|\Psi_i(\mathbf{r})|^2$ for all of the wave functions up to some 5000-th level for anisotropy γ from 0.05 to 0.98. For intermediate γ (0.85 – 0.5), the pattern varies level by level almost randomly, but we observe that there are recognizably characteristic patterns (around ten or so) that appear repeatedly. If we pick one level at random, and calculate its $|\Psi(\mathbf{r})|^2$, the pattern is similar to one of the characteristic patterns or a combination of a few of them. On the other hand, for higher anisotropy $\gamma < 0.5$, the probability pattern becomes so complex that we cannot identify characteristic pattern.

In Fig. 10, we exhibit two of characteristic patterns at $\gamma = 0.6$, $|\Psi_{438}|^2$ and $|\Psi_{579}|^2$ on the μ - ν plane. We have already stored periodic orbits by increasing order of the Bernoulli coding up to 8 binary digits. (For this task we benefited from a paper (Gutzwiller, 1981) which gives classification of AKP periodic orbits considering time-reversal and symmetries around axes.) In the figure selected periodic orbits that run on the μ - ν plane along the large value region

¹⁴ The choice of the energy is just to guarantee the visibility of the nodal line. One could choose equally $\Psi_{12500}(\mathbf{r})$ and the calculation of nodal lines is equally possible.

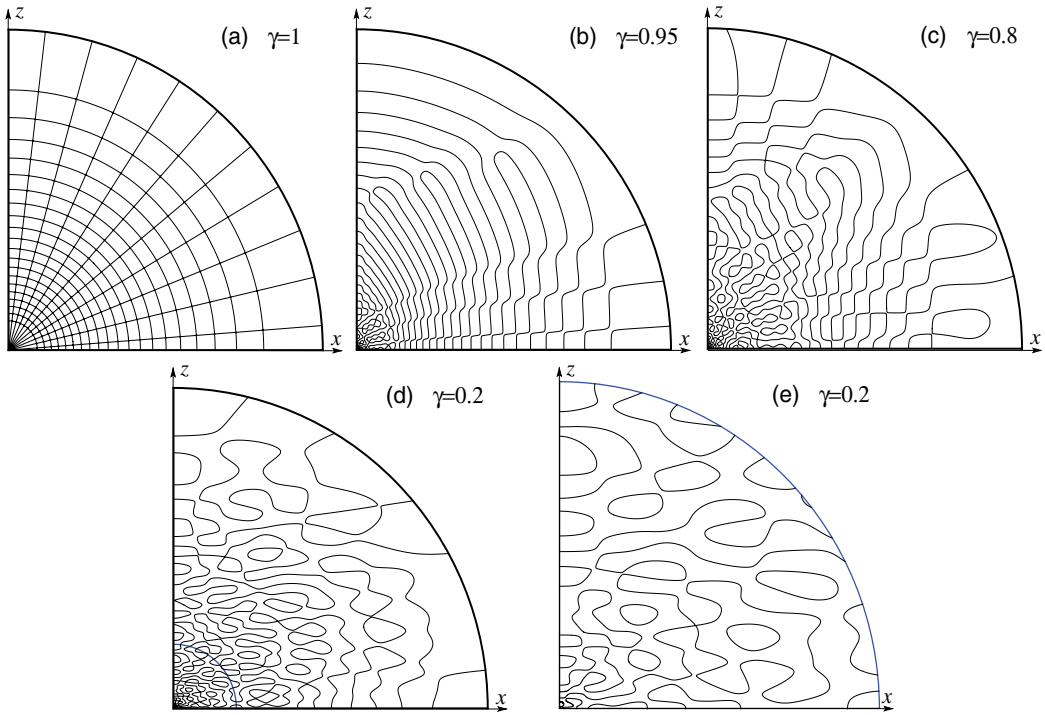

Fig. 9. Nodal lines of the AKP wave function $\Psi_i(\mathbf{r})$ with $i = 438$ in the sector $\ell = \text{even}$, $m = 0$ in the $x - z$ plane. (z axis, vertical, is the heavy axis). $\gamma = 1, 0.95, 0.8, 0.2$ for (a), (b),(c), [(d), (e)] respectively. The energies are approximately equal for all, and for the integrable case (a) $\Psi_{n_p=41, \ell=20, m=0}(\mathbf{r})$ is chosen among the degenerate levels. Two diagram are shown for $\gamma = 0.2$. The right is a magnified plot of $r \leq 0.2$ part of the left one.

of the probability distribution are also exhibited. These are the *scarring orbits* in the sense of (Heller, 1984; 1989). It seems that the association of one periodic orbit(PO) to one probability distribution is *not* ad hoc, since with the change of γ , both PO and large value region change keeping the association. This observation takes the advantage of one-parameter characteristic of AKP and we are consolidating this.

4.3 Husimi function and Poincaré surface of section

Husimi function for $|\Psi_n\rangle$ is

$$W_{\Psi_n}^{Hus}(\mathbf{q}_0, \mathbf{p}_0) = |\langle CHS | \Psi_n \rangle|^2 = \left| \sum_{i,j} \langle CHS | i, j; \kappa_n \rangle \langle i, j; \kappa_n | \Psi_n \rangle \right|^2. \quad (40)$$

Here $|CHS\rangle$ denotes the coherent state, a Gaussian packet centered at $(\mathbf{q}_0, \mathbf{p}_0)$ and width b

$$\langle \mathbf{q} | CHS \rangle = \frac{1}{\sqrt{\pi b}} e^{i\mathbf{p}_0 \cdot \mathbf{q} - \frac{(\mathbf{q}_0 - \mathbf{q})^2}{2b^2}}. \quad (41)$$

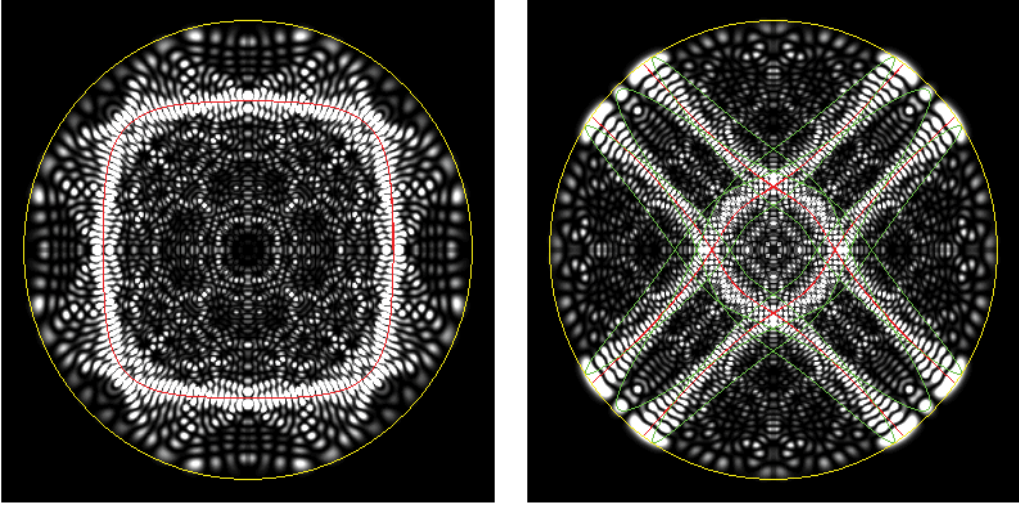

Fig. 10. AKP probability distributions in the $\mu - \nu$ plane. $\gamma = 0.6$, $m = 0$, $\ell = \text{even}$. Left: $|\Psi_{438}(\mathbf{r})|^2$. Right: $|\Psi_{579}(\mathbf{r})|^2$. Scarring short periodic orbits are also exhibited. Left: the primary periodic orbit $(+ -)$. Right: $(+ + - -)$ and $(+ + - + - -)$ exhibited by red and green respectively. Surrounding yellow circle shows the boundary of the classical motion.

Following (Müller & Wintgen, 1994) we obtain

$$\begin{aligned} |CHS\rangle &= |I_\mu, \eta_\mu\rangle_b \otimes |I_\nu, \eta_\nu\rangle_b \\ &= \frac{1}{\sqrt{\mathcal{I}_0(I_\mu)\mathcal{I}_0(I_\nu)}} \sum_{j,k=0}^{\infty} (-1)^{j+k} \left(\frac{I_\mu}{2}\right)^j \left(\frac{I_\nu}{2}\right)^k \frac{e^{2i(j\eta_\mu+k\eta_\nu)}}{j!k!} |j, k; 1/b^2\rangle \end{aligned} \quad (42)$$

where $|j, k; 1/b^2\rangle$ is given by (18) with $\kappa = 1/b^2$. In Fig. 11 we exhibit the Husimi function of Ψ_{438} and Ψ_{579} on the μ - p_μ plane. (The same wave functions with Fig. 10). We observe that the Poincaré section of periodic orbits that are associated with the large probability distributions in Fig. 10 (the scarring orbits) is now clearly sitting in the midst of the large value region of Husimi function (creating scars). It is interesting to note that the fundamental periodic orbit which creates a strong scar in Ψ_{438} seems to be creating an anti-scar in Ψ_{579} and the same contrast holds for other two PO's too. We finally mention that the patterns in Fig. 11 are remarkably reminiscent of the classical phase space structure presented in Fig. 1 of the seminal paper (Wintgen & Marxer, 1988). We are now extensively studying the correspondence between the quantum and classical phase space structures.

5. Future outlook

We discuss here two of currently pursuing problems.

5.1 Physics of quantum chaos and Anderson localization

For one thing, we contemplate to investigate the relation of quantum chaos to the Anderson localization — a very extensively studied branch of quantum physics (see for instance, Evers & Mirlin (2008)). The multi-fractality of AKP wave function was conjectured by (García-García

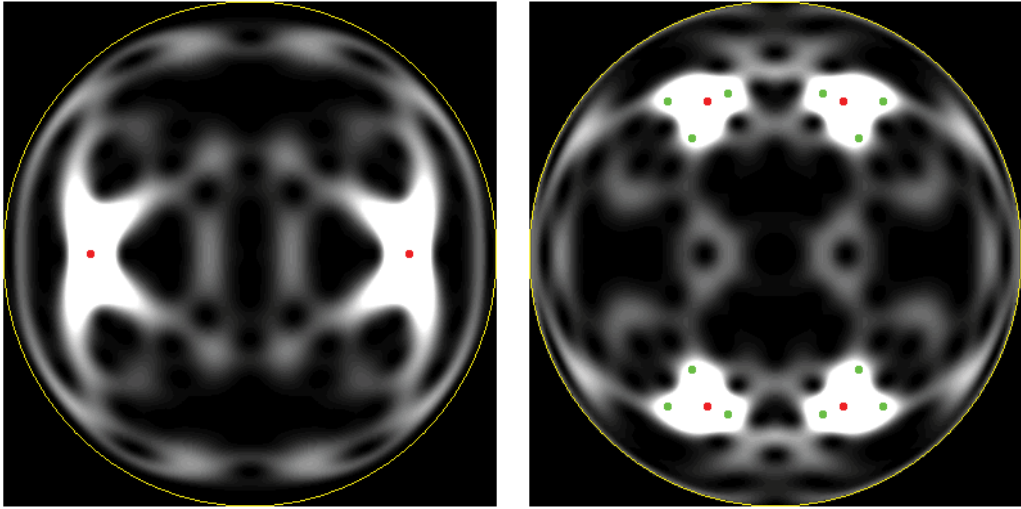

Fig. 11. Husimi function at Poincaré surface of section defined by $\nu = 0$ for Left: $\Psi_{438}(\mathbf{r})$ and Right: $\Psi_{579}(\mathbf{r})$. $\gamma = 0.6$, $m = 0$, $\ell = \text{even}$. White regions indicate large value. The Poincaré shots of scarring short periodic orbits in Fig. 10 are superposed. Surrounding yellow circle shows the boundary of the classical motion.

& Verbaarschot, 2003) and AKP was considered as a candidate system to test an interesting scheme *Anderson transition in quantum chaos* by (García-García, 2007).

The general picture of Anderson localization is as follows (Fyodorov & Mirlin, 1997). At the metallic phase, a typical wave function is extended, the overlap of wave functions of nearby energy levels leads to the repulsion, and the statistics is WD. Approaching the Anderson transition point E_c , the wave functions show up multi-fractal structure. The level statistics deviates from WD, but remarkably the repulsion still persists, which is an intrinsic feature of quantum dynamics of Anderson localization. The statistics at the transition point (the mobility edge), the critical level statistics, is just between WD and Poisson. Passing the transition point into the insulator side, the wave functions become well localized, the overlap is negligible, and the level statistics is Poisson.

Now we have seen, in the quantum chaos study of AKP, a very similar phenomenon (see Table 1).

Anderson localization	level statistics	quantum chaos (AKP)	classical AKP
insulator	Poisson	$\gamma \lesssim 1$	(decaying tori?)
Mobility Edge	critical statistics	$0.75 \lesssim \gamma \lesssim 0.85$	Cantori (Web of chaos)
metal	Wigner-Dyson	$\gamma \lesssim 0.6$	isolated unstable P. O.s

Table 1. Anderson localization and quantum chaos (AKP).

In order to consolidate this correspondence, a crucial test would be the verification of the multi-fractality of wave function in AKP in the region of critical level statistics.

The multi-fractal nature of the wave function at the mobility edge is reflected in the *compressibility* of the energy levels as seen as the one-dimensional gas

$$\Sigma^2(L) = \chi L \quad (L \gg 1) \quad (43)$$

where χ is a constant less than one. (For Poisson statistics, $\Sigma^2(L) = L$ and $\chi = 1$, while for WD statistics, $\Sigma^2(L) = c \log(L)$ and $\chi = 0$, see (30)). The value of χ is exactly expressed by a formula derived by Chalker et al. (1996a)

$$\chi = \frac{d - D_2}{2d} \quad (44)$$

where d is the system dimension and the multi-fractal dimension D_2 necessary for the $R_2(s)$ statistics quantity $\Sigma^2(L)$ is defined by

$$\left\langle \int d^d r |\psi_n(r)|^{2p} \right\rangle \propto L^{-D_p(p-1)} \quad (45)$$

with $p = 2$. As this is a key formula relating the level statistics and the wave function structure, let us briefly follow (Chalker et al., 1996a;b) for its derivation. The compressibility χ can be calculated from the spectral form factor $K(t)$ (the Fourier transform of the two level correlation function $R(s)$, $K(t) = \int_{-\infty}^{\infty} ds e^{-ist/t_H} R(s)$ with the Heisenberg time t_H ¹⁵) by taking a limit (Aronov et al., 1994; Kravtsov et al., 1994)

$$\chi = \int_{-\infty}^{\infty} R(s) ds \equiv \lim_{t \rightarrow 0} K(t). \quad (46)$$

Then there is a deep formula

$$K(t) = \frac{1}{2} \frac{|t| p(t)}{\pi \hbar \rho + \int_{0^+}^{|t|} p(t') dt'} \quad (47)$$

that gives the spectral form factor $K(t)$ by the return probability $p(t)$. It is introduced as a probability for the wave packet originally created in a small volume $V_0 = \ell^d$ to remain within this volume at time t

$$p(t) = \int d^d r \left\langle \sum_{k < \mathcal{N}_0} |\psi_n(r)|^2 |\psi_{n+k}(r)|^2 e^{-i \frac{(E_n - E_{n+k})t}{\hbar}} \right\rangle \quad (48)$$

with $\mathcal{N}_0 \sim L^d/V_0$. At this point the physics of energy levels meet the physics of eigenfunctions. The return probability should behave as

$$p(t) \sim V_0^{D_2/d-1} \left(\frac{\hbar \rho}{t} \right)^{D_2/d} \quad (49)$$

at the mobility edge (Chalker & Daniell, 1988; Chalker, 1990; Huckestein & Schweitzer, 1994). Now, inserting (49) into (47) and noting that the first term in the denominator is negligible compared with the second term

$$\pi \hbar \rho / \int_{0^+}^{|t|} p(t') dt' \propto \frac{1}{L^d} \left(\frac{t_H}{t} \right) t^{\frac{D_2}{d}} \rightarrow 0 \quad (50)$$

¹⁵ The Heisenberg time t_H is defined by $t_H = \hbar/\Delta$ and Δ is the mean level spacing $\Delta = 1/(\langle \rho \rangle L^d)$ with the system size L .

for $t \ll t_H$ and at $L \rightarrow \infty$, one ultimately obtains (44).

Coming back to AKP, we have seen already that the $\Sigma^2(L)$ for large L is linearly rising in the critical statistics region. Based on this observation (and with further support of kicked particle) García-García and Verbaarschot (García-García & Verbaarschot, 2003) conjectured the multi-fractal structure of AKP wave functions in this region. We are currently working to verify quantitatively this conjecture based on (49) by our AKP data. Once the comparison of Table 1 is established, it would also give a supporting contribution to the extremely ambitious theme *Anderson localization in quantum chaos* by García-García & Wang (2008).

5.2 A non-trivial test of periodic orbit theory in AKP

Our another concern is to understand the spectral rigidity $\Delta_3(L)$ of AKP from the periodic orbit theory following the seminal paper by (Berry, 1985). In terms of periodic orbits, the behavior of $\Delta_3(L)$ for $L \ll L_{max}$ is predicted universally by the contribution of very long classical orbits under the sum rule by (Hannay & Ozorio de Almeida, 1984).¹⁶ On the other hand, using a semi-classical sum rule, it is shown that the behavior of $\Delta_3(L)$ for $L \gg L_{max}$ is non-universally determined by the short periodic orbits. More precisely, it is of order $\hbar^{-(N-1)}$ for integrable models, and $\log(\hbar^{-1})$ for chaotic systems; the discrepancy comes from the manner of quantum interference. As we have described in the introduction, the isolated unstable orbits in AKP is symbolically coded by binary digits (Bernoulli sequences) and there is an amazing formula found by (Gutzwiller, 1980; 1981) that gives a good estimate of the action for each periodic orbits concisely and enables one to evaluate the contribution of whole periodic orbits. We have already checked, using our $\Delta_3(L)$ data, that the above L_{max} seems to give a right value for the change of $\Delta_3(L)$ from logarithmic rise to the asymptotic plateau. We are now trying to explain the plateau values of $\Delta_3(L)$ data for various γ from the contribution of short periodic orbits of AKP.

6. Conclusion

AKP is an old working ground which produced fruitful results on quantum chaos, especially via the pioneering works by Gutzwiller (Gutzwiller, 1971; 1977; 1980; 1981; 1982; 1990), and via the work by Wintgen (Wintgen & Marxer, 1988). It seems however that the focus of quantum chaos study has been shifted to elsewhere though for us it seems many things are still waiting for clarification in AKP. In this article we have extensively revisited AKP and have shed lights on its quantum features from the critical random matrix theories and from the insights from Anderson transition theories. We have in particular devoted ourselves to the quantitative investigation how the anisotropy in AKP affects systematically the quantum features of AKP. To this end, we have calculated quantum levels and wave functions from scratch. In section 2, we have recapitulated the vital WMB method (Wintgen et al., 1987) for the quantum levels. This method includes a key parameter ϵ and the effect in the eigenvalue calculation is exhibited in Fig. 1. Based on it, we have presented a prescription how to select the best ϵ for a given γ , and we have given simple rules (Fig. 3, 4). Besides the original WMB in AKP using the Sturmian basis, we have also formulated WMB calculation of AKP in terms of tensored harmonic basis. This in one hand provides us with a precise check of eigenvalues, and on the other hand, with necessary data for the Husimi function calculation. In section 3,

¹⁶ $L_{max} \sim \hbar^{-(N-1)}$ for a system of N freedoms.

we have investigated the energy level statistics and have shown that GV model (García-García & Verbaarschot, 2003) successfully describes the statistics in a range $0.75 \lesssim \gamma \lesssim 0.9$. The finite scaling property is under survey. We have furthermore obtained a simple rule $h \propto e^{7.2\gamma}$ that relates the effective temperature in the CS model (equivalent to GV random matrix model) to the AKP anisotropy. In section 4 we have investigated the wave functions and Husimi functions. In both, salient quantum scar of classical unstable periodic orbits are observed. We have found that the nodal line of the wave function (at given energy) increases its complexity and seems to extend a fractal structure. In section 5 we have discussed our current projects, one on the multi-fractality of wave functions that may be deeply related to the Anderson localization, and the other on the non-trivial test of the periodic orbit theory in terms of the finite non-universal asymptote in $\Delta_3(L)$.

Acknowledgement:

K. K. thanks the post doctoral fellowship from Meiji University, Japan. Both of us thank Professor M. C. Gutzwiller for kindly replying to our letter and also referring us to a stimulating paper (Gutzwiller, 1981).

7. References

- Aronov, A. G., Kravtsov, V. E. & Lerner, I. V. (1994). Spectral correlations in disordered electronic systems: Crossover from metal to insulator regime, *Physical Review Letters* 74: 1174-1177.
- Berry, M. V. (1985). Semiclassical theory of spectral rigidity, *Proceedings of Royal Society London* 400: 229-251.
- Berry, M. V. & Robnik, M. (1984). Semiclassical level spacings when regular and chaotic orbits coexist, *Journal of Physics A* 17: 2413-2421.
- Bohigas, O., Giannoni, M. J. & Schmit, C. (1984). Characterization of chaotic quantum spectra and universality of level fluctuation laws, *Physical Review Letters* 52: 1-4.
- Bohigas, O. & Giannoni, M. J. (1984). Chaotic motion and random matrix theories, in Dehesa, J. S., Gomez, J. M. G. & Polls, A. (ed.), *Mathematical and Computational Methods in Nuclear Physics, Lecture Notes in Physics Vol. 209*, Springer-Verlag, Berlin, pp. 1-99.
- Bohigas, O. (2005). Quantum chaos, *Nuclear Physics A* 751: 343c-372c.
- Calogero, F. (1969a). Solution of a three-body problem in one dimension, *Journal of Mathematical Physics* 10: 2191-2196.
- Calogero, F. (1969b). Ground state of a one-dimensional N -body system, *Journal of Mathematical Physics* 10: 2197-2200.
- Calogero, F. (1971). Solution of the one-dimensional N -body problems with quadratic and/or inversely quadratic pair potentials, *Journal of Mathematical Physics* 12: 419-436.
- Chalker, J. T. & Daniell, G. J. (1988). Scaling, diffusion, and the integer quantized hall effect, *Physical Review Letters* 61: 593-596.
- Chalker, J. T. (1990). Scaling and eigenfunction correlations near a mobility edge, *Physica A* 167: 253-258.
- Chalker, J. T., Kravtsov, V. E. & Lerner, I. V. (1996a). Spectral rigidity and eigenfunction correlations at the Anderson transition, *Journal of Experimental and Theoretical Physics Letters* 64: 386-392.
- Chalker, J. T., Lerner, I. V. & Smith, R. A. (1996b). Random walks through the ensemble: Linking spectral statistics with wave-function correlations in disordered metals,

- Physical Review Letters* 77: 554-557; Fictitious level dynamics: A novel approach to spectral statistics in disordered conductors, *Journal of Mathematical Physics* 37: 5061-5086.
- Chaudhury, S., Smith, A., Anderson, B. E., Ghose, S. & Jessen, P. S. (2009). Quantum signatures of chaos in a kicked top, *Nature* 461; 768.
- Courant, R. & Hilbert, D. (1953) *Methods of mathematical physics I*, Interscience Publishers, Inc.. See Fig. 7, 8 in Sec. 6 of Chap.6. (It is written that $r = 12$, but we consider it is a simple typographical error of $r = 6$.) The authors refer to the work by A. Stern (Bemerkungen über asymptotisches Verhalten von Eigenwerten und Eigenfunktionen, Dissertation, Göttingen, 1925).
- Dyson, F. J. (1962). Statistical theory of the energy levels of complex systems. I, II, III, *Journal of Mathematical Physics* 3: 140-156, 157-165, 166-175.
- Dyson, F. J. & Mehta, M. L. (1963). Statistical theory of the energy levels of complex systems. IV, *Journal of Mathematical Physics* 4: 701-712.
- Mehta, M. L. & Dyson, F. J. (1963). Statistical theory of the energy levels of complex systems. V, *Journal of Mathematical Physics* 4: 713-719.
- Evers, F. & Mirlin, A. D. (2008). Anderson transitions, *Review of Modern Physics* 80: 1355-1417.
- Fyodorov, Y. V. & Mirlin, A. D. (1997). Strong eigenfunction correlations near the Anderson-localization transition, *Physical Review B* 55: R16001-R16004.
- García-García, A. M. & Verbaarschot, J. J. M. (2003). Critical statistics in quantum chaos and Calogero-Sutherland model at finite temperature, *Physical Review E* 67: 046104-1 - 046104-13.
- García-García, A. M. (2007). Universality in quantum chaos and the one parameter scaling theory (a power point of a talk).
<http://www.tcm.phy.cam.ac.uk/~amg73/oslo2007.ppt>.
- García-García, A. M. & Wang, J. (2008). Universality in quantum chaos and the one-parameter scaling theory, *Physical Review Letters* 100: 070603-1 - 070603-4.
- Gutzwiller, M. C. (1971). Periodic orbits and classical quantization conditions, *Journal of Mathematical Physics* 12: 343-358.
- Gutzwiller, M. C. (1977). Bernoulli sequences and trajectories in the anisotropic Kepler problem, *Journal of Mathematical Physics* 18: 806-823.
- Gutzwiller, M. C. (1980). Classical quantization of a hamiltonian with ergodic behavior, *Physical Review Letters* 45: 150-153.
- Gutzwiller, M. C. (1981). Periodic orbits in the anisotropic Kepler problem, in Devaney, R. L. & Nitecki, Z. H. (ed.) *Classical Mechanics and Dynamical systems*, Marcel Dekker, New York, pp. 69-90.
- Gutzwiller, M. C. (1982). The quantization of a classically ergodic system, *Physica D* 5: 183-207.
- Gutzwiller, M. C. (1990). *Chaos in Classical and Quantum Mechanics*, Springer.
- Hannay, J. H. & Ozorio de Almeida, A. M. (1984). Periodic orbits and a correlation function for the semiclassical density of states, *Journal of Physics A* 17: 3429-3440.
- Hasegawa, H., Mikeska, H. J. & Frahm, H. (1988). Stochastic formulation of energy-level statistics, *Physical Review A* 38: 395-399.
- Heusler, S. et al. (2007). Periodic-orbit theory of level correlations, *Physical Review Letters* 98: 044103, 1-4.
- Hejhal, D. A. & Rackner, B. N. (1992). On the topography of Maass waveforms for $PSL(2, Z)$, *Experimental Mathematics* 1: 275-305.

- Heller, E. J. (1984). Bound-state eigenfunctions of classically chaotic hamiltonian systems: scars of periodic orbits, *Physical Review Letters* 53: 1515-1518.
- Heller, E. J. (1989). Wavepacket dynamics and quantum chaos, in Giannoni, M. J., Voros A. & Zinn-Justin J. (ed.) *Les Houches Summer School, Session LII, Chaos and quantum physics*, North-Holland, Amsterdam, pp. 547-664.
- Huckestein, B. & Schweitzer, L. (1994). Relation between the correlation dimensions of multifractal wave functions and spectral measures in integer quantum Hall systems, *Physical Review Letters* 72: 713-716.
- Husimi, K. (1940). Some formal properties of the density matrix, *Proceedings of the Physico-Mathematical Society of Japan* 22: 264-314.
- Kravtsov, V. E. et al. (1994). Universal spectral correlations at the mobility edge, *Physical Review Letters* 72: 888-891.
- Kravtsov, V. E. & Tselik, A. M. (2000). Energy level dynamics in systems with weakly multifractal eigenstates: Equivalence to one-dimensional correlated fermions at low temperatures, *Physical Review B* 62: 9888-9891.
- Kustaanheimo, P. & Stiefel, E. (1965). Perturbation theory of Kepler motion based on spinor regularization, *Journal für die reine und angewandte Mathematik* 218: 204-219.
- Marcus, C. M. et al. (1992). Conductance fluctuations and chaotic scattering in ballistic microstructures, *Physical Review Letters* 69: 506-509.
- Mehta, M. L. (2004). *Random Matrices*, 3rd ed. Academic Press, Amsterdam.
- Moshe, M., Neuberger, H. & Shapiro, B. (1994). Generalized ensemble of random matrices, *Physical Review Letters* 73: 1497-1500.
- Müller, K. & Wintgen, D. (1994). Scars in wavefunctions of the diamagnetic Kepler problem, *Journal of Physics B: Atomic, Molecular and Optical Physics* 27: 2693-2718.
- Pandey, A. (1979). Statistical properties of many particle spectra. Ergodic behaviour in random matrix ensembles, *Annals of Physics* 119: 170-191.
- Shklovskii, B. I., Shapiro, B. et al. (1993). Statistics of spectra of disordered system near the metal-insulator transition, *Physical Review B* 47: 11487-11490.
- Stein, J. & Stöckmann, H. -J. (1992). Experimental determination of billiard wave functions, *Physical Review Letters* 68: 2867-2870.
- Sutherland, B. (1971a). Quantum many-body problem in one dimension: Ground state, *Journal of Mathematical Physics* 12: 246-250.
- Sutherland, B. (1971b). Quantum many-body problem in one dimension: Thermodynamics, *Journal of Mathematical Physics* 12: 251-256.
- Weiss, D. et al. (1991). Electron pinball and commensurate orbits in a periodic array of scatterers, *Physical Review Letters* 66: 2790-2793.
- Wigner, E. P. (1951). On the statistical distribution of the widths and spacings of nuclear resonance levels, *Proceedings of the Cambridge Philosophical Society* 47: 790-798.
- Wintgen, D., Marxer, H. & Briggs, J. S. (1987). Efficient quantisation scheme for the anisotropic Kepler problem, *Journal of Physics A* 20: L965-L968.
- Wintgen, D. & Marxer, H. (1988). Level statistics of a quantized cantori system, *Physical Review Letters* 60: 971-974.
- Yukawa, T. & Ishikawa, T. (1989). Statistical theory of level fluctuations, *Progress of Theoretical Physics Supplement* 98: 157-172.
- Zaslavsky, G.M. et al. (1991). *Weak Chaos and Quasi Regular Patterns*, Cambridge University Press, Cambridge.

- Zirnbauer, M. R. & Haldane, F. D. M. (1995). Single-particle Green's functions of the Calogero-Sutherland model at couplings $\lambda = 1/2, 1,$ and 2 , *Physical Review B* 52: 8729-8745.
- Zirnbauer, M. R. (1996). Supersymmetry for systems with unitary disorder: Circular ensembles, *Journal of Physics A* 29: 7113.

Theory of Elementary Particles Based on Newtonian Mechanics

Nikolai A. Magnitskii
*LLC "New Inflow", Moscow,
Russia*

1. Introduction

The basis of modern conception of the world consists of two phenomenological theories (theory of quantum mechanics and theory of relativity), both largely inconsistent, but, in a number of cases, suitable for evaluation of experimental data. Both of these theories have one thing in common: their authors are convicted in limitations of laws and equations of classical mechanics, in absolute validity of Maxwell equations and in essential distinction of laws and mechanisms of the device of macrocosm and microcosm. Nevertheless, such assurance, being dominant in physics in the last hundred years, hasn't resulted in creation of unifying fundamental physical theory, nor in essential understanding of principal physical conceptions, such as: electric, magnetic and gravitational fields, matter and antimatter, velocity of light, electron, photon and other elementary particles, internal energy, mass, charge, spin, quantum properties, Planck constant, fine structure constant and many others. All laws and the equations of modern physics are attempts to approximate description of the results of natural experiments, rather than strict theoretical (mathematical) findings from the general and uniform laws and mechanisms of the device of the world surrounding us. Moreover, some conclusions from modern physics equations contradict experimental data such as infinite energy or mass of point charge.

In papers (Magnitskii, 2010a, 2011a) bases of the unifying fundamental physical theory which a single postulate is the postulate on existence of physical vacuum (ether) are briefly stated. It is shown, that all basic equations of classical electrodynamics, quantum mechanics and gravitation theory can be derived from two nonlinear equations, which define dynamics of physical vacuum in three-dimensional Euclidean space and, in turn, are derived from equations of Newtonian mechanics. Furthermore, clear and sane definitions are given to all principal physical conceptions from above through the parameters of physical vacuum, namely its density and propagation velocity of various density's perturbations. Thereby, it is shown that a set of generally unrelated geometric, algebraic and stochastic linear theories of modern physics, which are fudged to agree with experimental data and operating with concepts of multidimensional spaces and space-time continuums, can be replaced with one nonlinear theory of physical vacuum in ordinary three-dimensional Euclidean space, based exclusively on laws of classical mechanics.

In the present paper research of system of equations of physical vacuum is continued with the purpose of studying and the description of processes of a birth of elementary particles and their properties. A system of equations of electrodynamics of the physical vacuum,

generalizing classical system of Maxwell's equations and invariant under Galilean transformations is deduced. Definition of the photon is given and process of its curling and a birth from the curled photon of a pair of elementary particles possessing charge, mass and spin are described. The model of an elementary particle is constructed, definitions of its electric and gravitational fields are given and absence of a magnetic field is proved. Coulomb's law and Schrodinger's and Dirac's equations for electric field and also the law of universal gravitation for gravitational field are deduced. Definitions of electron, positron, proton, antiproton and neutron are given, and absence of graviton is proved. The elementary model of atom of hydrogen is constructed.

Postulate. All fields and material objects in the Universe are various perturbations of physical vacuum, which is dense compressible inviscid medium in three-dimensional Euclidean space with coordinates $\vec{r} = (x, y, z)^T$, having in every time station t density $\rho(\vec{r}, t)$ and perturbation propagation velocity vector $\vec{u}(\vec{r}, t) = (u_1(\vec{r}, t), u_2(\vec{r}, t), u_3(\vec{r}, t))^T$. With such problem definition, it's natural to consider that no external forces apply any tension on elements of physical vacuum. Therefore, in compliance with Newtonian mechanics equations of physical vacuum dynamics in the neighborhood of homogeneous stationary state of its density ρ_0 should be as follows:

$$\frac{\partial \rho}{\partial t} + \text{div}(\rho \vec{u}) = 0, \quad \frac{\partial(\rho \vec{u})}{\partial t} + (\vec{u} \cdot \nabla)(\rho \vec{u}) = 0, \quad (1)$$

where first equation is an equation of continuity, and second is the momentum equation. Let's notice, that the physical vacuum has no mass and in this connection dimension of its density does not coincide with dimension of substance (matter).

2. Electrodynamics of physical vacuum

Let's consider a case in which perturbation propagation velocity \vec{u} has a certain direction in physical vacuum set by unit vector \vec{n} . Solutions of the system of equations (1) we shall search in the form of

$$\vec{u}(\xi, t) = v(\xi, t)\vec{n} + w(\xi, t)\vec{m}, \quad \xi = (\vec{r} \cdot \vec{n}), \quad (\vec{m} \cdot \vec{n}) = 0, \quad \rho = \rho(\xi, t). \quad (2)$$

Note that the vector of perturbation propagation velocity in physical vacuum can have both transverse and longitudinal components in relation to the direction of propagation of perturbations. Substituting expression for the vector \vec{u} in equations (1) and taking into account, that

$$(w\vec{m} \cdot \nabla)(\rho \vec{u}(\xi, t)) = 0, \quad (v\vec{n} \cdot \nabla)(\rho \vec{u}(\xi, t)) = v \frac{\partial(\rho \vec{u})}{\partial \xi}, \quad \text{div}(\rho w \vec{m}) = 0, \quad \text{div}(\rho v \vec{n}) = \frac{\partial(\rho v)}{\partial \xi},$$

one can obtain a system of the equations for functions $\rho(\xi, t), v(\xi, t), w(\xi, t)$:

$$\frac{\partial \rho}{\partial t} + \frac{\partial(\rho v)}{\partial \xi} = 0, \quad \frac{\partial(\rho v)}{\partial t} \vec{n} + v \frac{\partial(\rho v)}{\partial \xi} \vec{n} = 0, \quad \frac{\partial(\rho w)}{\partial t} \vec{m} + v \frac{\partial(\rho w)}{\partial \xi} \vec{m} = 0, \quad (3)$$

which we call the *system of the equations of electrodynamics of physical vacuum*

2.1 Plane electromagnetic waves. Photon structure

In the particular case of transverse fluctuations of physical vacuum of constant density ($\rho(\xi, t) = \rho_0 = \text{const}$) and distribution of these fluctuations in a longitudinal direction with constant velocity $v(\xi, t) = c$ the system of equations (3) can be reduced to one equation in one complex variable $w(\xi, t)$:

$$\frac{\partial(\rho w)}{\partial t} \bar{m} + c \frac{\partial(\rho w)}{\partial \xi} \bar{m} = 0. \quad (4)$$

Let's introduce into consideration vectors of electric \vec{E} and magnetic \vec{H} fields intensities by the formulas:

$$\vec{H} = c \text{rot}(\rho \vec{u}), \quad \vec{E} = c(\vec{n} \cdot \nabla)(\rho \vec{u}). \quad (5)$$

In the general case of propagation of perturbations in compressible physical vacuum of variable density the vector of electric field intensity has both transverse and longitudinal components, and its divergence is not zero and can be interpreted as linear density of a charge (see item. 2.3). In the considered case of propagation of perturbations in physical vacuum of constant density with constant velocity only transverse component of a vector of electric field intensity is not zero, and its divergence is equal to zero. It is also clear that so defined vector of magnetic field intensity has only a transverse component, divergence of which also is equal to zero, and the vector $c\rho \vec{u} = \vec{A}$ is the vector of potential in classical electrodynamics.

Applying to the equation (4) consistently the operators $c \text{rot}$ and $c(\vec{n} \cdot \nabla)$ and taking into account, that in the considered case

$$\text{rot} \vec{H} = \text{rot}(c \text{rot}(\rho w \bar{m})) = -c \nabla^2(\rho w \bar{m}) = -c \frac{\partial^2(\rho w)}{\partial \xi^2} \bar{m}, \quad \vec{E} = c(\vec{n} \cdot \nabla)(\rho w \bar{m}) = c \frac{\partial(\rho w)}{\partial \xi} \bar{m},$$

we shall obtain the classical system of Maxwell's equations describing the propagation of electromagnetic waves in the so-called empty space (vacuum):

$$\begin{aligned} \frac{\partial \vec{H}}{\partial t} + c \text{rot} \vec{E} &= 0, \quad \text{div} \vec{H} = 0, \\ \frac{\partial \vec{E}}{\partial t} - c \text{rot} \vec{H} &= 0, \quad \text{div} \vec{E} = 0. \end{aligned} \quad (6)$$

The system of equations (6) has a solution in the form

$$\vec{E} = \vec{E}_0 e^{i(\omega t - k\xi)}, \quad \vec{H} = \vec{H}_0 e^{i(\omega t - k\xi)}, \quad \omega = kc. \quad (7)$$

It is considered to be, that the real parts of complex expressions (7) have physical sense. They determine an in-phase plane transverse electromagnetic wave, propagating with a speed of light c in any direction set by an unit vector \vec{n} . The unique characteristic of a classical plane electromagnetic wave is its frequency ω (or its wavelength $\lambda = 2\pi c / \omega$). Note, that in-phase vectors of electric and magnetic fields intensities periodically vanish simultaneously that contradicts the law of conservation of energy and raises doubts about validity of classical interpretation of an electromagnetic wave in which a change of the

electric field causes a change in the magnetic field and vice versa. In turn, the equation (4) has as its solution a spiral wave of constant amplitude w_0

$$w(\xi, t)\vec{m} = (w^* + w_0 e^{i(\omega t - k\xi)})\vec{m}, \quad \omega = kc, \quad (8)$$

propagating with velocity c in physical vacuum in a direction of a vector \vec{n} with conservation of energy carried by the wave and having arbitrary constant shift w^* in a direction of a vector \vec{m} . In such formulation the speed of light c in empty space has a clear physical sense - it is the propagation velocity of perturbations of physical vacuum of constant density in the absence of matter (the birth process of elementary particles of matter and antimatter as a result of perturbations of physical vacuum is described in Sec. 3). And since in this case the vectors \vec{E} and \vec{H} of a classical plane electromagnetic wave are a directional derivative and a rotor of a vector $c\rho_0 w(\xi, t)\vec{m}$, it is possible to conclude, that the classical electromagnetic wave (7) is an artificial form and is completely determined by the spiral wave (8) of perturbations propagation in physical vacuum, and

$$\vec{E}_0 = -ikc\rho_0 w_0 \vec{m}, \quad \vec{H}_0 = -ikc\rho_0 w_0 [\vec{m} \cdot \vec{n}]. \quad (9)$$

Suppose, for example, the transverse wave is propagated in physical vacuum in the direction of the axis y , so $w_0 \vec{m} = (w_{0x}, 0, w_{0z})^T$. Then $\xi = y$ and

$$\vec{E} = ck\rho_0 (w_{0x}, 0, w_{0z})^T \sin(\omega t - ky) = (E_{0x}, 0, E_{0z})^T \sin(\omega t - ky) = \vec{E}_0 \sin(\omega t - ky),$$

$$\vec{H} = ck\rho_0 (w_{0z}, 0, -w_{0x})^T \sin(\omega t - ky) = (E_{0z}, 0, -E_{0x})^T \sin(\omega t - ky) = \vec{H}_0 \sin(\omega t - ky).$$

That is, in full accordance with classical electrodynamics, vectors \vec{E}_0 and \vec{H}_0 are perpendicular to the axis y and perpendicular to each other, and their moduli are equal (Fig. 1a). In Fig. 1b for comparison the propagation of the spiral wave (8) in the physical vacuum of constant density is represented.

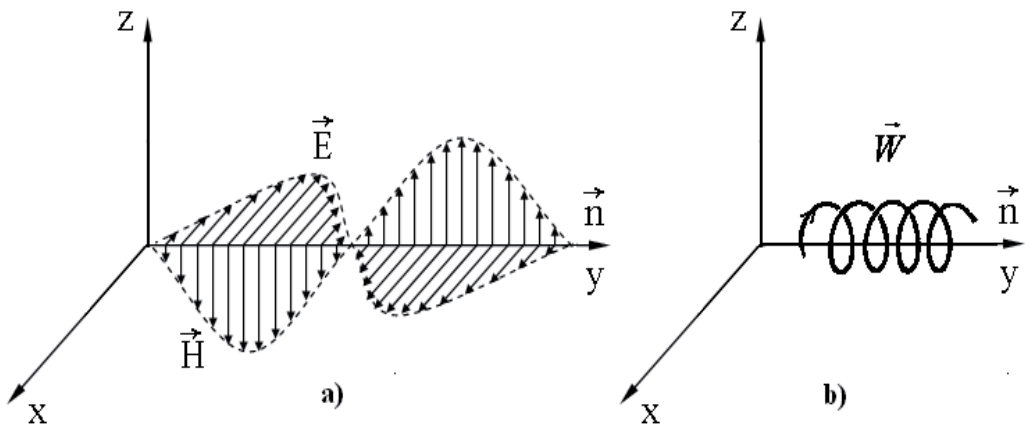

Fig. 1. Propagation of a classical plane electromagnetic wave (a) and a spiral wave of physical vacuum (b).

Now we can compare the spiral wave in the physical vacuum, obtained as the solution of the equation (4), and the classical electromagnetic wave, obtained as the solution of system of Maxwell's equations (6). Both waves have an arbitrary frequencies and corresponding wavelengths, so the two solutions describe all plane transverse electromagnetic waves existing in nature. However, it is easy to see from the above analysis, that the vectors of classical electric and magnetic fields are artificial vectors, namely, the derivatives of the same true vector of the velocity perturbations propagation in the physical vacuum. Furthermore, a classical electromagnetic wave (Fig. 1a) does not allow to correctly define the concept of a quantum of electromagnetic waves (photon), because it except for wavelength λ needs also knowledge of the oscillation amplitude. The kind of a spiral wave of perturbations propagation in physical vacuum allows the unique determination of the photon - it's a part of the cylindrical volume of the physical vacuum under a spiral of a wavelength λ and radius $r_0 = c / \omega = \lambda / 2\pi$. Wave motion on a spiral inside the given volume occurs with a constant angular velocity ω , and linear velocity reaches its maximum value (the speed of light c) on the lateral surface of the cylinder. Exactly such photon colliding with an obstacle and being compressed is capable to generate elementary particles and antiparticles in the form of balls of radius r_0 (for more details about the birth of elementary particles, see Sec. 3). In addition, among the solutions of Maxwell's equations (6) in the form of classical electromagnetic waves, in principle, there are no solutions corresponding to the constant shift w^* of transverse wave of physical vacuum (8). This, as it will be shown below, is the main reason that Maxwell's equations are not invariant under Galilean transformations, and, moreover, they cannot be modified so that they would satisfy these transformations.

2.2 Galileo transformations of electrodynamics equations

Consider an inertial rest reference frame $O(x, y, z)$ and moving relative to it uniformly and rectilinearly with constant velocity \vec{v} reference frame $O'(x', y', z')$. Without loss of generality, we assume that the respective axes are parallel to each other. Galilean transformations corresponding to common sense and centuries of experience are called transformations of coordinates and time in the transition from one inertial reference frame to another:

$$\vec{r}' = \vec{r} - \vec{v}t, \quad t' = t, \quad \vec{u}' = \vec{u} - \vec{v}.$$

Galilean transformation implies the same time in all frames of reference (absolute time). It is known also that all equations of classical mechanics are written the same in any inertial reference system, i.e. they are invariant under Galilean transformations. Let's show that any law, mathematical notation of which represents the full time derivative of any function $f(\vec{r}, t)$ of coordinates and time is invariant under the Galilean transformations. Indeed, taking into account, that $t' = t$ and $\nabla' = \nabla$ we shall obtain

$$\begin{aligned} \frac{df(\vec{r}, t)}{dt} &= \frac{\partial f(\vec{r}, t)}{\partial t} + (\vec{u} \cdot \nabla)(f(\vec{r}, t)) = \frac{\partial f'(\vec{r}', t')}{\partial t} + ((\vec{u}' + \vec{v}) \cdot \nabla)(f'(\vec{r}', t')) = \frac{\partial f'(\vec{r}', t')}{\partial t'} \frac{\partial t'}{\partial t} \\ &+ \frac{\partial f'(\vec{r}', t')}{\partial \vec{r}'} \frac{\partial \vec{r}'}{\partial t} + ((\vec{u}' + \vec{v}) \cdot \nabla)(f'(\vec{r}', t')) = \frac{\partial f'(\vec{r}', t')}{\partial t'} - (\vec{v} \cdot \nabla)(f'(\vec{r}', t')) + \\ &((\vec{u}' + \vec{v}) \cdot \nabla)(f'(\vec{r}', t')) = \frac{\partial f'(\vec{r}', t')}{\partial t'} + (\vec{u}' \cdot \nabla)(f'(\vec{r}', t')) = \frac{df'(\vec{r}', t')}{dt'}. \end{aligned}$$

From this assertion follows immediately that the physical vacuum equations (1) are invariant under the Galilean transformations, since

$$\frac{\partial(\rho\bar{u})}{\partial t} + (\bar{u} \cdot \nabla)(\rho\bar{u}) = \frac{d(\rho\bar{u})}{dt}, \quad \frac{\partial\rho}{\partial t} + \text{div}(\rho\bar{u}) = \frac{d\rho}{dt} + \rho(\nabla \cdot \bar{u}).$$

Also the system of equations of electrodynamics of physical vacuum (3) is invariant under the Galilean transformation that follows from the system of equations (1).

Now consider in reference frames $O(x, y, z)$ a spiral wave of perturbations of physical vacuum of the form

$$\bar{u}(\xi, t) = c\bar{n} + w(\xi, t)\bar{m} = c\bar{n} + w_0 e^{i(\omega t - k\xi)}\bar{m}, \quad \omega = kc, \quad \xi = (\bar{r} \cdot \bar{n}), \quad (\bar{m} \cdot \bar{n}) = 0. \quad (10)$$

As it shown above, to this solution of system of equations (1) with the function $w(\xi, t)$ satisfying the equation (4) there corresponds a classical electromagnetic wave, electric and magnetic fields intensities vectors of which are the directional derivative and the rotor of the vector $c\rho w(\xi, t)\bar{m}$. In accordance with the Galilean transformations the considered solution has the form in the frame of reference $O'(x', y', z')$

$$\begin{aligned} \bar{u}'(\xi', t) &= c\bar{n} - \bar{v} + w_0 e^{i(\omega' t - k\xi')}\bar{m}, \quad \xi' = (\bar{r}' \cdot \bar{n}) = \xi - (\bar{v} \cdot \bar{n})t, \\ \omega' &= \omega - k(\bar{v} \cdot \bar{n}) = k(c - (\bar{v} \cdot \bar{n})) = kc'. \end{aligned}$$

Expanding now the vector \bar{v} in the basis (\bar{n}, \bar{m}) : $\bar{v} = (\bar{v} \cdot \bar{n})\bar{n} - w^*\bar{m}$, we obtain

$$\bar{u}'(\xi', t) = c'\bar{n} + w'\bar{m} = c'\bar{n} + (w^* + w_0 e^{i(\omega' t - k\xi')})\bar{m}, \quad \omega' = kc'. \quad (11)$$

Solution (11) is the solution of equations (1) and (3) in the reference frame $O'(x', y', z')$. However, to obtain such solution from system of Maxwell's equations (6) is fundamentally impossible, even in case of failure of the postulate of the constancy of the speed of light with a replacement in (6) c on c' . The reason is that the differentiation of the solution (11) eliminates a constant shift w^* of transverse component of velocity of perturbations propagation. Note also that the transition from the solution (10) to the solution (11) is accompanied by the Doppler effect, that is changing of the oscillation frequency $\omega' = \omega - k(\bar{v} \cdot \bar{n})$. When a radiation source located in a reference frame $O(x, y, z)$ moves in the direction of an observer which is in the reference frame $O'(x', y', z')$, the oscillation frequency increases $((\bar{v} \cdot \bar{n}) < 0)$, and at movement in an opposite direction - decreases $((\bar{v} \cdot \bar{n}) > 0)$.

From the above it follows that, in contrast to the equations of a spiral wave (3) which are invariant under Galilean transformations, Maxwell's equations (6) describe the propagation of plane electromagnetic waves in moving inertial reference frames only approximately for small $w^* \ll c$. It is well known that the main cause of occurrence of the special theory of relativity in the early twentieth century were contradictions between electrodynamics, described by Maxwell's equations and classical mechanics, governed by the equations and Newton's laws. During the crisis of world science it was necessary to make a choice between two possibilities: a) either to admit that Maxwell's equations are not absolutely correct and are need to be changed so that they should satisfy the Galilean transformations; b) or to recognize that equations of classical mechanics are not quite correct and should be

considered only as an approximation to the true equations, satisfying the Lorentz transformations. Unfortunately, world science has chosen the second option, despite the reasoned objections of many outstanding scientists of the last century, among which the first is the name of Nikola Tesla (Tesla, 2003). The way chosen by world science has led to an absolutization of speed of light and Maxwell's equations and has led to full termination of researches in the field of search more general equations of electrodynamics satisfying the principle of Galilean relativity. The present research proves that the correct way to exit from the crisis of science in early twentieth century was not in updating the equations of classical mechanics with the use of relativistic additives but, on the contrary, in finding the equations generalizing Maxwell's equations and satisfying the Galilean transformations.

2.3 Longitudinal electromagnetic waves. Currents

Consider the general case of propagation of spiral waves (2) in physical vacuum of variable density. As shown in Sec. 2.1, these waves are solutions of the equations of electrodynamics of physical vacuum (3). Applying to the sum of the second and the third equations of system (3) consistently the operators $crot$ and $c(\vec{n} \cdot \nabla)$ we obtain for the electric and magnetic fields intensities vectors defined by formulas (5), the system of equations

$$\begin{aligned} \frac{\partial \vec{H}}{\partial t} + v \operatorname{rot} \vec{E} + \frac{\partial v}{\partial \xi} \vec{H} &= 0, \quad \operatorname{div} \vec{H} = 0, \\ \frac{\partial \vec{E}}{\partial t} - v \operatorname{rot} \vec{H} + \frac{\partial v}{\partial \xi} \vec{E} + cv \frac{\partial^2(\rho v)}{\partial \xi^2} \vec{n} &= 0, \quad \operatorname{div} \vec{E} = c \frac{\partial^2(\rho v)}{\partial \xi^2}. \end{aligned} \quad (12)$$

Note that in this case the electric field intensity vector \vec{E} has a nonzero longitudinal component even at $v = c = \text{const}$. This component is determined by small periodic compression-tension of density of physical vacuum in a longitudinal direction of propagation of electromagnetic wave.

Let's introduce into consideration the linear charge density ρ_{ch} and current density \vec{j} by the formulas

$$4\pi\rho_{ch} = \operatorname{div} \vec{E} = \operatorname{div} \left(c \frac{\partial(\rho v)}{\partial \xi} \vec{n} \right) = c \frac{\partial^2(\rho v)}{\partial \xi^2} = c \nabla^2(\rho v), \quad \vec{j} = \rho_{ch} v \vec{n}.$$

Then from (12) we shall obtain the system of equations

$$\begin{aligned} \frac{\partial \vec{H}}{\partial t} + v \operatorname{rot} \vec{E} + \frac{\partial v}{\partial \xi} \vec{H} &= 0, \quad \operatorname{div} \vec{H} = 0, \\ \frac{\partial \vec{E}}{\partial t} - v \operatorname{rot} \vec{H} + \frac{\partial v}{\partial \xi} \vec{E} + 4\pi \vec{j} &= 0, \quad \operatorname{div} \vec{E} = 4\pi\rho_{ch}. \end{aligned} \quad (13)$$

The system of equations (13) at $v = c = \text{const}$ is a classical system of Maxwell's equations in the presence of charges and currents. It follows from here that charges and currents can exist in physical vacuum even at the absence of substance (matter) in it. Thus, a current in the sense of classical system of Maxwell's equations (13) at $v = c = \text{const}$ is not the motion of charges, but it is the second derivative (Laplacian) from propagating with the speed of light longitudinal wave of periodic compression - stretching of density of physical vacuum.

Note that the substance (matter) is formed by elementary particles with the space charge and being waves of compression - stretching of density of physical vacuum, propagating along the parallels of spheres of radius $r \leq r_0$ (see Sec. 3). Therefore, in substance the propagation of longitudinal waves (currents) also is possible.

As it is already mentioned above, the classical system of Maxwell's equations describing propagation of electromagnetic waves in presence of charges and currents can be obtained from (13) at $v = c$. However, in general, the velocity of propagation of longitudinal waves in physical vacuum is not constant, but undergoes small periodic oscillations around the constant c . Therefore, the generalized system of equations of electrodynamics (13) has a much wider spectrum of solutions in comparison with the classical system of Maxwell's equations. In addition, the first two equations of system (13) at $v = c = \text{const}$ representing the Faraday's law of induction

$$\frac{\partial \vec{H}}{\partial t} + c \text{rot } \vec{E} = 0, \quad \text{div } \vec{H} = 0,$$

can be obtained by applying the operator $c \text{rot}$ directly to the linearized second equation of the physical vacuum equations (1). Therefore, these equations can be considered approximately always satisfied, but it is impossible to say about the second pair of equations of system (13), which are not always executed. Moreover, as follows from the analysis of item 2.2, the system of equations (13) and, consequently, the system of Maxwell's equations are not absolutely correct for the reason that they do not satisfy the Galilean transformations and describe the propagation of electromagnetic waves in moving inertial reference frames only approximately for small velocities of movement of such systems relatively to the speed of light. In all cases of the description of processes of propagation of both transverse and longitudinal waves in physical vacuum the system of equations (3) is correct. For the description of other more complex perturbations of physical vacuum connected, for example, with a birth of elementary particles and their electric and gravitational fields, it is necessary to use directly the equations of physical vacuum (1) (see Sec. 3).

3. Elementary particles of a matter

We show in this section that processes of a birth of elementary particles of matter and antimatter from the physical vacuum (ether), as well as all basic quantum-mechanical properties of elementary particles can be obtained from the system of equations (1) written in spherical system of coordinates:

$$\begin{aligned} \frac{\partial \rho}{\partial t} + \frac{1}{r^2} \frac{\partial(r^2 \rho V)}{\partial r} + \frac{1}{r \sin \theta} \frac{\partial(\rho \Omega \sin \theta)}{\partial \theta} + \frac{1}{r \sin \theta} \frac{\partial(\rho W)}{\partial \varphi} &= 0, \\ \frac{\partial(\rho V)}{\partial t} + V \frac{\partial(\rho V)}{\partial r} + \frac{\Omega}{r} \frac{\partial(\rho V)}{\partial \theta} + \frac{W}{r \sin \theta} \frac{\partial(\rho V)}{\partial \varphi} &= 0, (\vec{r}) \\ \frac{\partial(\rho \Omega)}{\partial t} + V \frac{\partial(\rho \Omega)}{\partial r} + \frac{\Omega}{r} \frac{\partial(\rho \Omega)}{\partial \theta} + \frac{W}{r \sin \theta} \frac{\partial(\rho \Omega)}{\partial \varphi} &= 0, (\vec{\theta}) \\ \frac{\partial(\rho W)}{\partial t} + V \frac{\partial(\rho W)}{\partial r} + \frac{\Omega}{r} \frac{\partial(\rho W)}{\partial \theta} + \frac{W}{r \sin \theta} \frac{\partial(\rho W)}{\partial \varphi} &= 0, (\vec{\varphi}) \end{aligned} \quad (14)$$

where $\vec{u} = (V_r, V_\theta, V_\varphi)^T$, $V_r = V$, $V_\theta = \Omega$, $V_\varphi = W$, and unit coordinate vectors (\vec{r}) , $(\vec{\theta})$, $(\vec{\varphi})$, which define vector directions of corresponding equation lines, are in brackets after equations.

3.1 Birth of elementary particles from physical vacuum

Let's consider a spiral wave of photon (8)

$$w(\xi, t)\vec{m} = w_0 e^{i(\omega_* t - k_* \xi)} \vec{m}, \quad \omega_* = k_* c, \quad \xi = (\vec{n} \cdot \vec{r}),$$

propagating with the velocity c in physical vacuum in the direction of a vector \vec{n} and having a wavelength $\lambda = 2\pi / k_*$ and radius of the outer spiral $r_0 = c / \omega_* = 1 / k_*$. Colliding with an obstacle (a field of an atomic nucleus or other photon), the wave is compressed in the direction of the vector \vec{n} and bifurcated into a solution of the system of equations (14), in which the linear speed of rotation of the wave by the angle φ is equal to $W = (c / r_0) r \sin \theta$ (the direction of the axis z in (14) coincides with the direction of the vector \vec{n}). Such a solution of the system (14), describing the compressed or curled photon, as well as all other solutions, describing various elementary particles, we shall search among the solutions with zero coordinate of velocity vector by the angle θ .

So, we shall put in (14) $\Omega = 0$ and result in **equation system of elementary particles**:

$$\begin{aligned} \frac{\partial \rho}{\partial t} + \frac{1}{r^2} \frac{\partial(r^2 \rho V)}{\partial r} + \frac{1}{r \sin \theta} \frac{\partial(\rho W)}{\partial \varphi} &= 0, \\ \frac{\partial(\rho V)}{\partial t} + V \frac{\partial(\rho V)}{\partial r} + \frac{W}{r \sin \theta} \frac{\partial(\rho V)}{\partial \varphi} &= 0, \quad (\vec{r}) \\ \frac{\partial(\rho W)}{\partial t} + V \frac{\partial(\rho W)}{\partial r} + \frac{W}{r \sin \theta} \frac{\partial(\rho W)}{\partial \varphi} &= 0, \quad (\vec{\varphi}) \end{aligned} \quad (15)$$

The solution for the curled photon we shall find from the system (15), putting in it $W = (c / r_0) r \sin \theta$, $V = 0$. Then we shall obtain $\rho = \rho_0(1 + q_0(r) \exp(i(\omega_* t - \varphi)))$. That is, at curling the photon is transformed into a longitudinal wave of small compression - stretching of the density of physical vacuum, propagating on parallels inside a sphere of radius r_0 with constant angular velocity $\omega = \omega_* = c / r_0$. Curled photon has no mass and charge, so it can hypothetically apply for the role of neutrino though this hypothesis requires additional check and experimental confirmation.

Let's show now that equation system (15) has solutions, which possess all known properties of elementary particles when $r \leq r_0$ is small enough. These solutions will be sought as waves propagating with constant angular velocity by the angle φ under the influence of small-amplitude oscillations of physical vacuum density

$$W = \frac{c}{r_0} r \sin \theta, \quad \rho(r, \varphi, t) = \rho_0 + q(r, \varphi, t) \quad (16)$$

and small-amplitude oscillations of function $V(r, \varphi, t) \neq 0$ when $r \leq r_0$ is small enough. That is every elementary particle is some bifurcation from curled photon. Under such problem formulation, each elementary particle is a sphere of radius r_0 , inside of which waves, created by small-amplitude oscillations of physical vacuum density, propagating along to any parallel (circle with radius $r \sin \theta$, $r \leq r_0$) with constant angular velocity

(frequency) c/r_0 , making full roundabout way by angle $0 \leq \varphi \leq 2\pi$ over equal time $T = 2\pi r \sin \theta / W = 2\pi r_0 / c$. In addition, linear velocity of these waves increases linearly with the radius, reaching its maximum value (velocity of light c) on sphere's equator when $r = r_0$, $\sin \theta = 1$ (Fig.2).

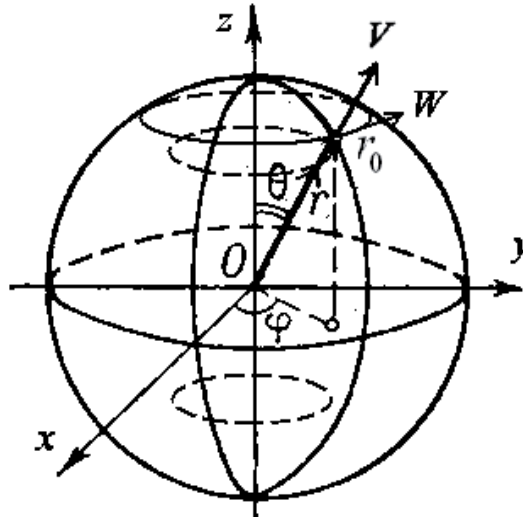

Fig. 2. Scheme of any elementary particle.

Substitution of assumed form of solution of (16) into equation system (15), with a drop of second infinitesimal order terms and multiplications of small terms, will result in the following system of equations

$$\begin{aligned} \frac{\partial q}{\partial t} + \rho_0 \left(\frac{\partial V}{\partial r} + \frac{2V}{r} \right) + \frac{c}{r_0} \frac{\partial q}{\partial \varphi} &= 0, \\ \frac{\partial V}{\partial t} + \frac{c}{r_0} \frac{\partial V}{\partial \varphi} &= 0, \quad (\bar{r}) \\ \frac{\partial q}{\partial t} + \rho_0 \frac{V}{r} + \frac{c}{r_0} \frac{\partial q}{\partial \varphi} &= 0, \quad (\bar{\varphi}) \end{aligned} \quad (17)$$

It is necessary to notice that at such approximation nonlinear term of second infinitesimal order $V \partial(\rho V) / \partial r \bar{r}$ has been entirely neglected. The role of this term becomes significant only with relatively large $r \rightarrow \infty$ and, probably, with relatively small $r \rightarrow 0$. As it will be shown below, this term exactly generate gravitational field of a particle with relatively large r . It is rather probable, that the same term describes nuclear interactions at $r \rightarrow 0$.

It's not difficult to get the solutions of equation system (17) in the following form

$$V(r, \varphi, t) \approx \frac{V_0}{r} e^{i(\omega t - k r_0 \varphi)}, \quad \omega = ck, \quad \rho(r, \varphi, t) \approx \rho_0 \left(1 - \frac{V_0 r_0}{c r^2} \varphi e^{i(\omega t - k r_0 \varphi)} \right). \quad (18)$$

However, not every solution in form (16), (18) is an elementary particle. Such solution has to possess properties of charge conservation and universality, as well as quantum properties of mass, momentum and energy. Moreover, over the time of full roundabout way of the wave

along the sphere equator, electric field intensity must conserve its sign. Such classical and quantum mechanical terms as electric and magnetic field of elementary particle, its charge, mass, energy, momentum, spin also need correct definitions through the characteristics of physical vacuum.

First, let's give the definition of electric field and electric charge of elementary particle similarly to the case of plane electromagnetic waves propagation, examined above.

Definition. *Electric field intensity distribution \vec{E} and charge density distribution ρ_{ch} of elementary particle will be defined as:*

$$\vec{E} = E\vec{r} = \frac{W}{r \sin \theta} \frac{\partial(\rho V)}{\partial \varphi} \vec{r}; \quad \rho_{ch} = \frac{1}{4\pi} \text{div} \left(V \frac{\partial(\rho W)}{\partial r} \vec{\varphi} \right). \quad (19)$$

It follows from (16) and (18) that inside a particle at $r \leq r_0$

$$\vec{E} = E\vec{r} = \frac{c}{r_0} \frac{\partial(\rho V)}{\partial \varphi} \vec{r} \approx -\frac{ikr_0 c \rho_0 V_0}{r_0 r} e^{i(\omega t - kr_0 \varphi)} \vec{r}; \quad \rho_{ch} \approx -\frac{ikc \rho_0 V_0}{4\pi r^2} e^{i(\omega t - kr_0 \varphi)}. \quad (20)$$

Let's determine an instant value of the charge q_{ch} of elementary particle. Let $\omega t = 2\pi l + kr_0 \varphi_*$, where $0 \leq kr_0 \varphi_* < 2\pi$. Integrating the density distribution of charge over sphere's volume with radius r_0 we shall obtain

$$\begin{aligned} q_{ch} &= -\int_0^{\pi \varphi_* + 2\pi r_0} \int_{\varphi_*} \int_0^{\pi} \frac{ikc \rho_0 V_0}{4\pi r^2} e^{i(kr\varphi_* - kr_0 \varphi)} r^2 \sin \theta \, dr d\varphi d\theta = \\ &= \frac{c \rho_0 V_0}{2\pi} (e^{-i2\pi k r_0} - 1) = \begin{cases} 0, & kr_0 = n/2, \quad n = 2m, \quad m = 0, 1, \dots \\ -\frac{c \rho_0 V_0}{\pi}, & kr_0 = n/2, \quad n = 2m + 1. \end{cases} \quad (21) \end{aligned}$$

What follows from formula (21) is that solution (16), (18) of the equation system (15) can be interpreted as an elementary particle only in such case, when wave number kr_0 is an integer or a half-integer value. For integer value of kr_0 the charge is zero, for any half-integer value of kr_0 charge equals common by modulus universal value $q = c \rho_0 V_0 / \pi$.

Integrating the density distribution of charge over sphere's volume with radius r_0 for $\varphi_* - 2\pi \leq \varphi \leq \varphi_*$ we shall obtain positive value of particle charge q . Thus there are actually two particles bifurcating from curled photon (particle and antiparticle), which have the same frequencies $\omega = n\omega_*/2$ and charges, which modules are equal to q , but have opposite signs. In that case the wavelengths of created periodic solutions by the angle φ are less than 2π in half-integer value of times. That is time of the wave's full roundabout way by angle $0 \leq \varphi \leq 2\pi$ along any parallel of the sphere with radius r_0 equals integer number $2kr_0$ of half-periods $T_p = \pi / \omega = \pi / kc$ of physical vacuum density and electric field intensity oscillations, which conserves its sign on the last uneven half-period, being equal to the charge's sign.

It's important to point out that electric field of elementary particle directed along radius is created by particle's electric charge, but at the same time the charge is divergence of a completely different inner field of the particle, which is represented by second term in the third equation of equation system (15) and directed by the angle φ . Also notice that electric field intensity distribution of elementary particle inside the particle (that is within the

sphere of radius r_0) defined by the third term in the second equation of equation system (15), decreases as $1/r$, so it removes the problem of infinite energy and mass of elementary particles.

3.2 Other basic properties of elementary particles

Let's now determine other properties of an elementary particle: internal energy ε , mass m , momentum p and spin σ . Expressions of Planck constant \hbar , as well as fine structure constant, which can be rightfully called the most mysterious constant of microcosm physics, will also be derived. First, let's determine internal energy formula with a use of expression of work A , executed by field forces of the particle

$$\frac{dA}{dt} = \int_B \Lambda \vec{F} \cdot \vec{W} dB. \quad (22)$$

Here B is the volume of elementary particle sphere of radius r_0 , \vec{F} is the field, which influences on charges distributed inside a sphere with distribution density Λ and has a nonzero projection on velocity vector \vec{W} , that is on direction of vector $\vec{\varphi}$. This field can not be electric field, which is directed along radius \vec{r} . This field can only be the summary field directed by angle $\vec{\varphi}$ from the third equation of system (15)

$$\vec{F} = V \frac{\partial(\rho W)}{\partial r} \vec{\varphi} + \frac{W}{r \sin \theta} \frac{\partial(\rho W)}{\partial \varphi} \vec{\varphi} \approx -ik \frac{c \rho_0 V_0 \sin \theta}{r} \varphi e^{i(\omega t - kr_0 \varphi)} \vec{\varphi},$$

and it has to execute the work over not only electric charge with distribution density ρ_{ch} , but also over all other charges determined by divergence of this field. After determination of full charge distribution density

$$\Lambda = \text{div} \vec{F} = -\frac{ikc \rho_0 V_0}{r^2} \frac{\partial}{\partial \varphi} (\varphi e^{i(\omega t - kr_0 \varphi)})$$

let's insert it as well as derived expression of internal field \vec{F} into the formula (22) to get the following expression

$$\begin{aligned} \frac{dA}{dt} &= -\int_B \frac{k^2 c^3 \rho_0^2 V_0^2 \sin^2 \theta}{2r_0 r^2} \frac{\partial(\varphi e^{i(\omega t - kr_0 \varphi)})^2}{\partial \varphi} dB = \\ &= -e^{2i\omega t} \int_0^\pi \int_0^{2\pi} \int_0^{r_0} \frac{k^2 c^3 \rho_0^2 V_0^2 \sin^2 \theta}{2r_0 r^2} \frac{\partial(\varphi^2 e^{-2ikr_0 \varphi})}{\partial \varphi} r^2 \sin \theta dr d\varphi d\theta. \end{aligned}$$

Integrating the last equation and taking into account that $\omega = kc$ one can obtain finally

$$A = ie^{2i\omega t} \frac{4kc^2 \rho_0^2 V_0^2 \pi^2}{3}; \quad \varepsilon = |A| = \frac{4\pi^2}{3} kc^2 \rho_0^2 V_0^2.$$

Now, to derive the well-known main formulas and correlations of quantum mechanics, it's suffice to denote the mass of elementary particle and Planck constant as

$$m = \frac{4\pi^2}{3} k \rho_0^2 V_0^2 = \frac{4\pi^2}{3} \omega \rho_0^2 V_0^2 / c; \quad \hbar = \frac{4\pi^2}{3} c \rho_0^2 V_0^2.$$

From this it follows immediately:

- Einstein's formula for internal energy of a particle and formulas of impulse and energy for de Broglie's waves

$$\varepsilon = mc^2, \quad p = mc = \hbar k, \quad \varepsilon = \hbar \omega;$$

- formula for spin of a particle

$$\sigma = mcr_0 = \frac{4\pi^2}{3} kr_0 c \rho_0^2 V_0^2 = kr_0 \hbar = \frac{n}{2} \hbar, \quad n = 0, 1, 2, \dots$$

- fine structure constant formula

$$\alpha = \frac{q^2}{\hbar c} = \frac{c^2 \rho_0^2 V_0^2}{\pi^2 4\pi^2 c^2 \rho_0^2 V_0^2 / 3} = \frac{3}{4\pi^4} \approx \frac{1}{137}.$$

These formulas, derived exclusively by the methods of classical mechanics, are completely identical to the well-known expressions of quantum mechanics as well as clearly reflect the physical essence of charge, mass, energy and spin of elementary particles, allowing to understand the nature of quantum processes in microcosm. It can be seen that the internal energy of the particle is indeed proportional to the square of velocity of light, and proportionality coefficient (mass of the particle) linearly grows with the increase of wave number k , as well as frequency ω of the parental photon. The Plank constant is indeed a constant value depending only on characteristics of physical vacuum and not on the type of the elementary particle. The spin of the particle indeed has a value of either integer or half-integer number of \hbar , which allows to separate all elementary particles in two general categories: bosons and fermions. Still, the most surprising and encouraging fact is the almost precise match of the fine structure constant α with its experimental value of $1/137$.

Note also that the simplest particles with the spin of $\frac{1}{2}$ when $n = 1$ are double period cycles in relation to the initial cycle defined by the motion of curled photon. That brings another proof of the theory introduced in this research – the interpretation of the Pauli principle, the corollary fact of which is that electron returns to the initial state only after the turn of 720, not 360 degrees. According to R. P. Feynman (Feynman & Weinberg, 1987), particle with topology of Moebius band meets the Pauli principle. But in the Feigenbaum-Sharkovskii-Magnitskii universal theory of dynamical chaos (FSM theory) (Magnitskii, 2008a, 2008b, 2009, 2010b, 2011b; Magnitskii & Sidorov, 2006; Evstigneev & Magnitskii, 2010), results of which valid for every nonlinear differential equation system of macrocosm, the solution's difficulty increase starts from double period bifurcation of the original singular cycle. Interesting enough, the newborn cycle of doubled period belongs to the Moebius band around the original cycle! In another words, according to the FSM theory electron and proton are initial and simplest double period bifurcations from the infinite bifurcation cascade. Therefore, FSM theory works not only in macrocosm, but also in microcosm, and elementary particles defined by formulas (16), (18), are not a full infinite set of all elementary particles, which can be born as a result of bifurcations in nonlinear

equation system (15). Furthermore, more complex nonperiodic solutions of systems (14) and (15) can be foreseen, which are singular attractors in terms of FSM theory. Thus, any attempts of an experimental detection of the simplest (most elementary), as well as the most complex of elementary particles are essentially futile.

3.3 Some main classical equations and laws

Another proof of validity of the theory presented in this paper is the possibility of a rigorous mathematical conclusion from its unique postulate on existence of physical vacuum of some important phenomenological equations and laws of the modern physics which are widely used by classical electrodynamics and quantum mechanics and not contradicting to common sense interpretation of variables included in them. We consider here the Coulomb's law and Schrodinger's and Dirac's equations.

3.3.1 Coulomb's law

We assume that outside of a particle of radius r_0 change of density of physical vacuum practically does not occur. Then, neglecting the third equation of (17), we shall obtain, that at $r > r_0$

$$V(r, \varphi, t) \approx \frac{V_0 r_0}{r^2} e^{i(\omega t - k r_0 \varphi)}, \quad \omega = ck, \quad r > r_0.$$

The vector of electric field intensity distribution of a particle will become

$$\vec{E} = E \vec{r} \approx -\frac{ikr_0 c \rho_0 V_0}{r^2} e^{i(\omega t - k r_0 \varphi)} \vec{r}. \quad (23)$$

Then a vector of electric field intensity of an elementary particle $\vec{E}(r)$ we shall find, averaging instant value of a vector of intensity distribution by the angle φ . Let $\omega t = 2\pi l + k r_0 \varphi_*$, where $0 \leq k r_0 \varphi_* < 2\pi$. Then for the particles having a negative charge $-q$, we shall obtain

$$\vec{E}_- = -\frac{1}{2\pi} \int_{\varphi_*}^{\varphi_* + 2\pi} \frac{ikr_0 c \rho_0 V_0}{r^2} e^{i(kr\varphi - k r_0 \varphi)} \vec{r} d\varphi = -\frac{c \rho_0 V_0}{\pi r^2} \vec{r} = -\frac{q}{r^2} \vec{r}.$$

For the particles having a positive charge $+q$, averaging of instant value of a vector of electric field intensity distribution by the angle φ in the interval $\varphi_* - 2\pi \leq \varphi \leq \varphi_*$ will give $\vec{E}_+ = (q / r^2) \vec{r}$. Obtained expressions coincide with expressions for intensity of an electric field of a charge in the Coulomb's law, and for a particle having a negative charge, the vector of electric field intensity is directed on radius to the center of a particle, and for a particle having a positive charge, the vector of electric field intensity of a particle is directed on radius from its center.

3.3.2 Schrodinger's equation

Let's show, that for a free particle of mass m the solution of the Schrodinger's equation

$$i\hbar \frac{\partial \psi}{\partial t} = -\frac{\hbar^2}{2m} \Delta \psi \quad (24)$$

is a scalar function $E^*(r, \varphi, t)$, which is a complex conjugate function to an electric field intensity distribution function of an elementary particle from expression (20). As

$$\frac{\partial E^*}{\partial t} = -i\omega E^*, \quad \frac{\partial^2 E^*}{\partial \varphi^2} = -k^2 r_0^2 E^*, \quad \frac{\partial E^*}{\partial t} = \frac{i\omega}{k^2 r_0^2} \frac{\partial^2 E^*}{\partial \varphi^2} = \frac{i\omega}{k^2 r_0^2} r^2 \sin^2 \theta \Delta E^*,$$

then averaging the right part of last expression by the angle θ , we shall obtain in a neighborhood of a sphere of an elementary particle of radius r_0

$$\frac{\partial E^*}{\partial t} \approx \left(\frac{1}{\pi} \int_0^\pi \frac{i\omega}{k^2} \sin^2 \theta d\theta \right) \Delta E^* = i \frac{c^2}{2\omega} \Delta E^*.$$

Multiplying the last expression on $i\hbar$ we shall obtain

$$i\hbar \frac{\partial E^*}{\partial t} = -\frac{c^2 \hbar}{2\omega} \Delta E^* = -\frac{\varepsilon \hbar}{2\omega m} \Delta E^* = -\frac{\omega \hbar^2}{2\omega m} \Delta E^* = -\frac{\hbar^2}{2m} \Delta E^*,$$

that coincides with the equation (24). Thus, it becomes clear a physical sense of ψ - function in the Schrodinger's equation for a free particle - it is the electric field intensity distribution of an elementary particle near the surface of its sphere.

3.3.3 Dirac's equation

It was already shown in (Magnitskii, 2010a, 2011a) that electric field intensity and charge of elementary particle defined above agree with electromagnetic form of Dirac's equation for electron in bispinor form. Here we shall consider this question in more detail. Dirac's equation in bispinor form has a kind

$$i\hbar \frac{\partial \psi}{\partial t}(\vec{r}, t) = (c \sum_{j=1}^3 \alpha_j p_j + \alpha_0 m_e c^2) \psi(\vec{r}, t), \quad (25)$$

that is a consequence of operator equation

$$\hat{\varepsilon}^2 \psi = c^2 \vec{p}^2 \psi + m_e^2 c^4 \psi, \quad \hat{\varepsilon} = i\hbar \frac{\partial}{\partial t}, \quad \vec{p} = -i\hbar \vec{\nabla}, \quad (26)$$

where m_e is mass of electron or other fermion, $\hat{\varepsilon}$ and \vec{p} are operators of energy and momentum and α_j - Dirac's matrixes. In the theory of electrodynamics of curvilinear waves (EDCW) of A.Kyriakos (Kyriakos, 2006) the electromagnetic form of Dirac's equation is deduced. It is shown, that if the electromagnetic wave of a photon is propagating in a direction z , then at its hypothetical curling and a birth from it a pair of elementary particles the 4-vector (E_x, E_y, H_x, H_y) of electromagnetic wave of each of particles satisfies the Dirac's equations in bispinor form. So, to show, that the vector function of electric field intensity distribution of an elementary particle in a vicinity of its equator satisfies the equations (25) and (26) we should write down system of the equations of elementary particles (15) in cylindrical system of coordinates which axis z coincides with the axis of rotation of an elementary particle:

$$\begin{aligned}
\frac{\partial \rho}{\partial t} + \frac{1}{r} \frac{\partial(r\rho V)}{\partial r} + \frac{1}{r} \frac{\partial(\rho W)}{\partial \varphi} &= 0, \\
\frac{\partial(\rho V)}{\partial t} + V \frac{\partial(\rho V)}{\partial r} + \frac{W}{r} \frac{\partial(\rho V)}{\partial \varphi} &= 0, \quad (\bar{r}) \\
\frac{\partial(\rho W)}{\partial t} + V \frac{\partial(\rho W)}{\partial r} + \frac{W}{r} \frac{\partial(\rho W)}{\partial \varphi} &= 0, \quad (\bar{\varphi})
\end{aligned} \tag{27}$$

Solution of the system (27), consistent with a solution of the system (19) in the vicinity of the equatorial areas of the elementary particle, has the following kind:

$$W = (c / r_0)r, \quad V(r, \varphi, t) \approx V_0 e^{i(\omega t - kr_0 \varphi)}, \quad \omega = ck, \quad \bar{E} = \frac{c}{r r_0} \frac{\partial(\rho V)}{\partial \varphi} \bar{r} = E \bar{r}.$$

Then, as it is easy to verify by the direct substitution, the vector \bar{E} is an approximate solution of the second order equation

$$\frac{\partial^2 \bar{E}}{\partial t^2} - c^2 \nabla^2 \bar{E} + \omega_p^2 \bar{E} = 0.$$

in the vicinity of $r \approx r_0$, where ∇^2 is Laplace operator in cylindrical coordinate system and the frequency $\omega_p = c / r_0$ is an angular velocity, which can be interpreted as an oscillation frequency of the curled photon electromagnetic wave with a wavelength $\lambda = 2\pi r_0$. Multiplying the obtained equation by $(i\hbar)^2$ and using the relation $\hbar\omega = mc^2$, we obtain for vector \bar{E} an equation

$$\hat{\varepsilon}^2 \bar{E} = c^2 \hat{p}^2 \bar{E} + m_p^2 c^4 \bar{E}. \tag{28}$$

Equation (28) differs from the equation (26) those, that in it instead of the electron mass m_e there is the mass of the curled photon $m_p = 2m_e$ until the moment of its division into two particles: an electron and a positron. Hence, the vector of electric field intensity distribution of each separate elementary particle after their division is the solution of equations (25) and (26) written in cylindrical system of coordinates.

Therefore, the true physical meaning of wave function ψ from Dirac equation for electron in bispinor form (25) becomes clear - it's a 4-vector (E_x, E_y, H_x, H_y) of particle's electromagnetic wave, but in such elementary particles model, as opposed to the case of plain electromagnetic waves propagation, magnetic field intensity vector is a virtual one, since it is directed on an axis z , while velocity vector component V_z equals to zero. Therefore, there is no real magnetic field of an elementary particle in a considered model.

3.4 Electron, positron, proton, antiproton, neutron and atom of hydrogen

It's obvious, that more complex, multi-curled elementary particles correspond to high-frequency perturbation waves with bigger mass and energy. So, it's natural to imply that the simplest half-curled particles with the spin of $1/2$ when $n = 1$ are pairs "electron-positron" and "proton-antiproton". Both pairs of particles have the same mechanism of a birth. The difference is in the values of frequencies of parental photons and, accordingly, in radiuses of their curling r_0 and in masses of the born particles. Experimental data testify that the

mass of proton is in three orders greater than the mass of electron. Consequently, the wave frequency of proton is in three orders greater than the wave frequency of electron and, that is important, the radius of proton is in three orders smaller than the radius of electron. That is, the electron is not a small particle that rotates around the nucleus of an atom, and it is a huge ball which size is comparable to the size of the crystal lattice of substance. This implies that the current in the conductors can not be a movement of free electrons.

It is obvious that the charges of proton and electron should have different signs. Thus, their combinations can form atoms of substance only in the case when the electric field intensity of a particle of smaller radius (proton) is directed to its center, and, accordingly, the electric field intensity of a particle of the greater radius (electron) is directed from its center. That is, proton should have a negative charge in the sense of expression (20), and electron should have a positive charge. Then for instant density of physical vacuum of proton ρ_p inside a sphere with radius of its curling r_p we shall obtain the expression

$$\operatorname{Re} \rho_p = \operatorname{Re} \frac{1}{2\pi} \int_{\varphi_0}^{\varphi_0+2\pi} \rho_0 \left(1 - \frac{r_p c V_0}{c r^2} \varphi e^{i(kr\varphi_0 - kr_0 \varphi)}\right) d\varphi = \rho_0 \left(1 + \frac{4V_0 r_p}{\pi c r^2}\right) > \rho_0.$$

Similar expression we shall receive for instant density of physical vacuum of electron ρ_e inside a sphere with radius of its curling r_e :

$$\operatorname{Re} \rho_e = \operatorname{Re} \frac{1}{2\pi} \int_{\varphi_0-2\pi}^{\varphi_0} \rho_0 \left(1 - \frac{r_e c V_0}{c r^2} \varphi e^{i(kr\varphi_0 - kr_0 \varphi)}\right) d\varphi = \rho_0 \left(1 - \frac{4V_0 r_e}{\pi c r^2}\right) < \rho_0.$$

Consequently, proton is compressed, and electron is rarefied areas of physical vacuum with respect to its stationary density ρ_0 . Elementary antiparticles positron and antiproton are, obviously, in pairs to electron and proton, and have charges of opposite signs, that is their waves are formed by additional half-periods of the waves of double period with respect to the waves of the original photons.

Consider now the possibility of the formation from a pair of proton-electron of the simplest electrically neutral structures, such as neutron and atom of hydrogen. Since the electron has a much larger radius than the radius of a proton, then in the most part of elements of physical vacuum laying inside of the electron, the electric field of the electron directed from its center, less than an electric field of the proton directed to its center. Therefore, an electron having got in area of its capture by an electric field of a proton, should move in its direction until some stable structure in the form of a sphere with a radius of an electron, in which center there is a nucleus as a sphere with a radius of a proton is formed. The electric field intensity outside of an external sphere is equal to zero, as at $r > r_e$

$$\vec{E} = E\vec{r} = \vec{E}_e + \vec{E}_p = \frac{q}{r^2}\vec{r} - \frac{q}{r^2}\vec{r} = 0, \quad r > r_e.$$

We can assume that the simplest atom of hydrogen, as well as arbitrary neutron are arranged in this manner. The neutron can differ from the atom of hydrogen in radius and, accordingly, in frequencies of oscillations of waves of its electron and proton. In Fig. 3 a diagram of a hydrogen atom and also a picture of a real hydrogen atom made in Japan (Podrobnosti, 04.11.2010) are presented.

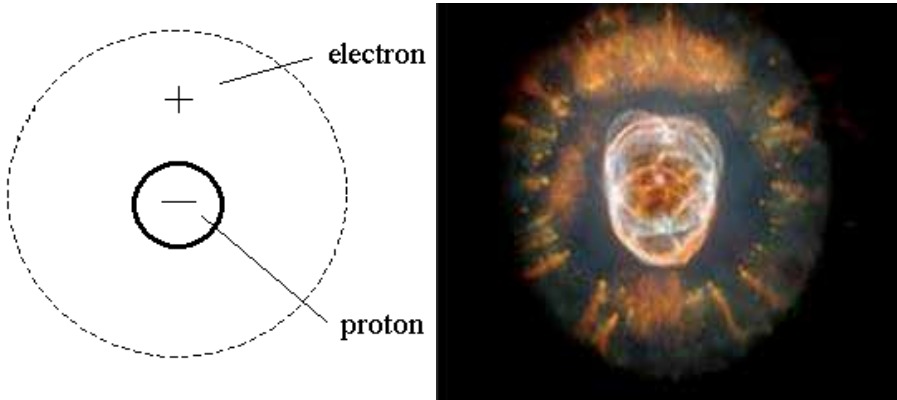

Fig. 3. The scheme (at the left) and the photo of a real hydrogen atom.

In this model, the impossibility of formation of atoms of antimatter can be easily explained by the fact that the electric field of the antiproton, which has much smaller radius than the positron, is directed from its center, which prevents the formation of stable structures of antimatter.

4. Gravitation and gravitational waves

Let's demonstrate that the creation of any elementary particle is accompanied by appearance of the gravitation, notably the pressure force in physical vacuum, generated by small periodic perturbations of its density, which in its own turn generate gravitational wave, propagating to the center of newborn particle. It's natural to propose that gravitation works over any distance from the particle, and that when the distance is large, perturbations of physical vacuum density created by the newborn particle depend only on distance r and are independent of angles θ and φ . Based on such assumption, let's seek solutions of system (15) when r is large in the following form:

$$\rho = \rho_0 + q(r, t), \quad V = V(r, t), \quad W = 0.$$

Equation system (15) will take a form

$$\frac{\partial \rho}{\partial t} + \frac{1}{r^2} \frac{\partial(r^2 \rho V)}{\partial r} = 0, \quad \frac{\partial(\rho V)}{\partial t} + V \frac{\partial(\rho V)}{\partial r} = 0, \quad (29)$$

meaning that of all four fields in the initial system (15) only gravitational field $G = V \partial(\rho V) / \partial r$ will remain significant when r is large enough.

Furthermore, gravitational field differs from three other previously examined fields since it's severely nonlinear. It can't be linearized basing on the form of velocity W component in analogue with electric and two internal fields of the particle. When r is small and, consequentially, V is small as well, gravitational field can be neglected during the formulation of elementary particles theory. On the contrary, when r is relatively large, all other fields with the exception of gravitational are can be neglected, and that agrees with experimental data. But when $r \rightarrow 0$ V again starts to grow and so we can propose that gravitational term describes also nuclear interactions.

Let's seek the solution of equation system (29) in the form of $V = c / r^2$, that is in the form of a gravitational (radial) wave, which propagates to the center of elementary particle ($r = 0$) with velocity dependant on radius. With the use of function V in equation system (29) and in case of $r \rightarrow \infty$ next expression for small oscillation of physical vacuum density will be derived

$$\rho(r, t) \approx \rho_0(1 + q(r, t)) = \rho_0(1 + q_0 e^{i(\omega t + kr^3/3)}), \quad \omega + kc = 0.$$

In this case the pressure force of gravitational wave (gravitational field intensity) expresses as

$$G = V \frac{\partial(\rho V)}{\partial r} \approx \frac{c^2}{r^4} \frac{\partial q}{\partial r} = \frac{iq_0 kc^2}{r^2} e^{i(\omega t + kr^3/3)},$$

and it agrees with the law of universal gravitation. However, the physical essence of gravitation comes in somewhat different light than before. The bodies do not attract each other – each material body creates its own gravitational wave, which propagates from infinity to its center of mass and puts an external pressure on other body with the force, proportional to the mass of the body and inversely proportional to the square of distance between the bodies.

Let's note another significant difference between gravitational and electromagnetic waves. Electromagnetic wave moving with constant velocity has a wavelength, thus, resulting in the existence of electromagnetic wave quant or photon. Gravitational wave moves with velocity dependant on radius, thus, there can be no gravitational wave quant. Traditional parallel between the gravitational wave and its hypothetical carrier, graviton, is apparently the main obstacle for the real discovery of gravitational waves in nature.

5. Conclusion

The theoretical research carried out in the work and its results allow to draw several fundamental conclusions and statements which looks more than plausibly:

- all fields and material objects in the Universe are various perturbations of physical vacuum, microcosm and macrocosm are organized by the same laws – laws of classical mechanics, described by nonlinear differential equation systems in tree-dimensional plane Euclidean space and bifurcations in such systems;
- electromagnetic fields can exist without mass and gravitation, and electromagnetic waves can propagate in any direction with constant velocity (velocity of light) and arbitrary oscillation frequency, which is defined by oscillation frequency of physical vacuum without changes of its density;
- there exist equations, more common than Maxwell equations, deduced from the physical vacuum equations and invariant concerning Galileo transformations, many experimentally established laws of classical and quantum mechanics can be successfully deduced from the physical vacuum equations;
- existence of gravitation, mass and charge inseparably linked with the creation of elementary particles in form of curls of a single gravi-electromagnetic field, the attracting force is actually a pressure force in physical vacuum created by gravitational wave, which propagates to the center of the particle with variable velocity and has no wave length;

6. References

- Evstigneev, N. & Magnitskii, N. (2010). On possible scenarios of the transition to turbulence in Rayleigh-Benard convection. *Doklady Mathematics*, Vol. 82, No.1, pp. 659-662.
- Feynman, R. & Weinberg, S. (1987). *Elementary Particles and the Laws of Physic*. Dirac Memorial lectures. Cambridge University Press, Cambridge, 138p.
- Kyriakos, A. *Theory of the nonlinear quantized electromagnetic waves, adequate of standard model theory*. Sp.B. BODlib, 2006, 208 p.
- Magnitskii, N. & Sidorov, S. (2006). *New Methods for Chaotic Dynamics*. World Scientific, Singapore, 360p.
- Magnitskii, N. (2008). Universal theory of dynamical chaos in nonlinear dissipative systems of differential equations. *Commun. Nonlinear Sci. Numer. Simul.*, Vol.13, pp. 416-433.
- Magnitskii, N.(2008). New approach to analysis of Hamiltonian and conservative systems. *Differential Equations*, Vol.44 , No.12, pp. 1682-1690.
- Magnitskii, N. (2010). *Mathematical theory of physical vacuum*. New Inflow, Moscow, 24p.
- Magnitskii, N. (2010). On topological structure of singular attractors. *Differential Equations*, Vol.46, No.11, pp.1552-1560.
- Magnitskii, N. (2011). Mathematical theory of physical vacuum. *Commun. Nonlinear Sci. Numer. Simul.* Vol.16, pp. 2438-2444.
- Magnitskii, N.(2011). *Theory of dynamical chaos*. URSS , Moscow, 320p. (in Russian)
- Tesla N. (2003). Lectures, patents, articles. Tesla Print, Moscow, 198p.
- Podrobnosti (04.11.2010). Available from
<http://podrobnosti.ua/technologies/2010/11/04/728672.html>

Better Unification for Physics in General Through Quantum Mechanics in Particular

Cynthia Kolb Whitney
Galilean Electrodynamics
USA

1. Introduction

Physics has always had several different domains of application in on-going development, and physicists have always striven for unification among its different domains. Unification is usually achieved through development of so-called 'covering theories'. In the nineteenth century, the stunning example was Maxwell's Electrodynamics (MED), which unified electricity and magnetism as one domain of theory. Another major domain of theory then present was Newton's Mechanics (NM), which in the eighteenth century had really launched modern physics as a mathematical discipline.

At the turn of the twentieth century, NM and MED were well in place, and were fulfilling many technologically important requirements. But there seemed to be an incompatibility between them. The problem concerned their invariance with respect to choice of reference frame: NM exhibited invariance if the allowed reference frames were all connected through Galilean transformations, whereas MED exhibited invariance if the allowed reference frames were all connected through Lorentz transformations. It looked as though one of these two theories must be more nearly correct than the other, but it was not clear which one was the better one.

That problem seemed resolved with the advent of Einstein's Special Relativity Theory (SRT). SRT was believed to capture the true meaning of MED concerning the behavior of light signals, and SRT was certainly an endorsement of Lorentz transformation, so SRT was believed to offer the one possible revision of NM that could make mechanics fully consistent with MED.

But meanwhile, new phenomena were being discovered at the micro scale of physics, and they often seemed inexplicable with any known theory, whether NM, SRT, or MED. These were phenomena suggesting quantization of light, quantized atomic states, atomic, molecular and crystal structures, radioactivity, *etc.*

So at almost the same time as one problem seemed to be resolved, other problems were emerging. Since the earlier situation between NM and MED had demanded that Physics allow two seemingly discordant theories to co-exist until some good argument could replace one of them, the situation then presented by the new phenomena being discovered naturally invited the development of another potentially discordant theory: Quantum Mechanics (QM).

The discovery of the photoelectric effect, and the introduction of the idea of the photon, initiated QM. Almost immediately, QM was developed to handle the Hydrogen atom, and the ground state thereof, the stability of which was thought to be impossible with MED.

Accepting that apparent incompatibility with MED, and even embracing it, researchers moved on to excited states, to other atoms, then to molecules, and reactions, and to all the rest of the complexity that today makes up modern Quantum Chemistry (QC).

Also, experimenters got into sub-atomic elementary particles, especially electrons and positrons, their annihilation and creation, along with creation and annihilation of photons. All that led to Quantum Electrodynamics (QED).

So today physics still has several different bodies of theory, aimed at several different domains of application. On the one hand, we have QM for atomic and other micro-system interactions. It has at least two identifiable parts: QC for interactions at the level of atoms and molecules, and QED for interactions at the level of elementary particles. And on the other hand, we have Einstein's relativity theory (RT) for physics at human scale and larger. It too has two parts: SRT for electromagnetic interactions, and general relativity theory (GRT) for gravitational interactions.

QM and RT are the major pillars of twentieth century physics. And they are not entirely compatible. QM features wave-like entities with seemingly instantaneous correlations between the states of even quite distant entities, whereas RT features point-like entities interacting via fields propagating at a finite speed.

So are we defeated in the quest for unification in Physics? Apparently many people hope not, as they do vigorously pursue various forms of unification. The prominent one sought today is Quantum Gravity (QG). It would be the twenty-first century capstone for the two twentieth-century pillars of QM and RT. But it is not yet fully in sight.

In the pursuit of unification, one often sees phrases like 'Theory of Everything'. The objective of this Chapter is certainly modest by comparison! It just notes some observations about the status of available theories, and discusses the removal of some incompatibilities between the available theories that arose only because of unfortunate choices.

Because QM is relatively new, there are still lots of alternative approaches being developed in parallel. Putz (2009) gives us one very big and recent anthology about them, and this book will give another even more recent one. The QM atmosphere is clearly right for generating new illumination that can facilitate new observations about physics overall.

The first observation driving the present work is just this: QED is arguably the most successful theory that modern Physics possesses. The fact that QED now exists, and that it has the name that it has, naturally begs the question: How could there have been any real disconnect between MED¹ and early QM?

It is this author's belief that Nature is not so perverse. Connections between different domains of theory are still possible to find, even though the diligent search that was conducted a century ago did not find them. We have developed more tools now. Every new tool developed should invite us to revisit the old problems.

Section 2 talks about the photon from the point of view of MED. It explores the implications of the finite energy, which characterizes a photon. It finds a plausible model for the photon expressed in terms of MED.

The second observation is just this: If MED can connect better with QM, then shouldn't SRT also connect better with QM? After all, how much difference can there be between a photon in QM and a light signal in SRT?

¹ Note that I speak of MED, not of Classical Electrodynamics (CED) in general. CED involves, not only the works of Maxwell, but also those of a large number of other individuals. I am inclined to trust results from Maxwell, but question some of those from other authors, as reported in the present work.

Section 3 explores the implications of modeling the light signal in SRT in the same way as the photon in QM. The photon model suggests a slight alteration to Einstein's second postulate, and thereby produces a slightly altered version of SRT.

The third observation is just this: If SRT is to be altered, however slightly, in response to the photon concept from QM, isn't it then possible that the revised SRT can be used to better explain some things about QM that presently seem mysterious?

Section 4 talks about what the photon/signal model implies about atoms: the stability of atoms, the occurrence of Planck's constant.

The fourth observation is this: Much of science works on scaling laws. It is in that spirit that we should look for scaling laws about atoms, and thereby reduce the effort of looking at each element as a particular special-case problem for detailed calculations.

Section 5 talks about the inferences from the story about all isotopes of Hydrogen, all elements beyond Hydrogen, and the ions of any element; the possible nature of 'excited' atomic states, and the character of the light spectrum that an element produces.

The fifth observation is this: If QM can be better connected to SRT, then where does that leave its relationship with NM? Early QM was basically NM, although not for particles possessing momentum and energy in the classical way, but rather for waves, with an amplitude factor and a phase factor, in the latter of which momentum and energy appeared as variables. Is that formulation now completely outdated on account of a rift between NM and MED?

Section 6 establishes that there was no necessary disconnect even between NM and MED. It argues that, with an adequately extended notation to support an extended tensor calculus, Maxwell's equations can be seen to be invariant in form, even under Galilean transformation. (It is useful here to distinguish two kinds of invariance: 'form invariance' for symbolic equations, and 'number invariance' for individual symbols that have numerical values.)

The last observation is the 'meta' observation about the present work: Physics in general can become significantly more unified throughout because of some specific developments surrounding QM.

Section 7 summarizes the several specific conclusions implied by the present work. Boiled down to one sentence, these conclusions come to this: the existence of apparent discord between theories that are addressed to different problem domains within Physics sometimes means that there exists a more productive way to pose one or more of the theories involved.

2. Maxwell's electrodynamics and QM's photons

It often seems that MED, a theory largely about spatially extended EM fields, has little in common with QM, a theory largely about discrete material systems and the discrete photons that they emit and absorb. Photons are imagined to be the opposite of spatially extended; *i.e.*, localized, like the matter particles that emit and absorb them.

So our mental picture for a photon in its interactions with matter is rather bullet-like: the photon is shot out of a source, travels through space, and hits a receiver that absorbs it. But the travel part of the story is unobservable. So we imagine that the photon in flight is possibly wavelike, in accord with Maxwell theory. Certainly the evidence for that is present, in the form of interference effects, even with small numbers of photons. So the photon is assigned a quality of 'duality'. This is a rather mysterious way of describing a photon.

What seems missing here is an adequate model for the photon throughout its life history, expressed in terms of EM fields. The purpose of this Section is to develop one.

I like to begin the development of such a history with a waveform consisting of finite energy distributed in a three-dimensional Gaussian peak located very close to a source that has emitted it. This three-dimensional Gaussian peak is limited in all three spatial directions so as to integrate to a finite total energy.

To allow subsequent propagation, the energy has to be divided between two orthogonal fields, electric and magnetic. To allow circular polarization, the energy has to be further divided between real and imaginary parts, real being alive now, and imaginary becoming alive a quarter of an oscillation cycle later.

Given such a start, the whole life history of a photon can then develop in the manner that Maxwell's equations allow. Describing that development is the objective of the following Sub-Sections.

2.1 Waveform development

The first step in the life history of a photon is its development from a spatially localized energy bundle that is emitted from a source into a spatially extended waveform that travels through space. To help think about this problem, it is useful to recall some phenomenology familiar from physics at a more macroscopic scale.

1. One phenomenon very well known for light modeled as EM waves is the spreading transverse to the propagation direction known as of 'diffraction'. Diffraction is the result of some sort of limitation transverse to the propagation direction. Historically, the limitation has been due to a finite aperture through which the light propagates. The light spreads out from the aperture, more-so the smaller the aperture is. In the photon model discussed here, the limitation is softer than an aperture edge, but a limitation nevertheless: it is the finite spread of the Gaussian waveform in the two directions transverse to the propagation direction. The more narrow the Gaussian peak is, the more spread there will be.

But sideways spreading is not the main requirement for a photon model; spreading in the longitudinal direction is what is most needed. Could longitudinal spreading be caused in a manner similar to diffraction, by the initial waveform limitation in the longitudinal direction?

2. The closest familiar analog for longitudinal spreading is known as 'dispersion'. This word refers to the 'blurring' effect that any frequency dependence the propagation speed through the medium entails. For example, a signal pulse in a medium loses its sharp edges because those sharp edges imply superposition of many different wavelengths, and hence different frequencies, which the medium may affect differently. In Earth's atmosphere, or ocean, square waves can turn to blob waves because of dispersion.

But we don't have the traditional medium-induced frequency dispersion for a photon in free space. So 'dispersion' isn't a close analog for any effect that may be induced by longitudinal limitation due to the finite spread of the Gaussian waveform in the longitudinal direction.

For the photon model, we need to find and combine just the useful features from both the diffraction and dispersion ideas. Here is a workable approach. Diffraction comes out of optical system response in the spatial domain. Dispersion comes out of transmission system response in the temporal domain. Maxwell's equations link space and time variation together. So we look at pulse profiles in the longitudinal direction, and allow Maxwell's equations to work on them.

Let us begin a scenario with a single pulse in E . Let it have a Gaussian profile along the propagation direction, say x , with $E \propto \exp(-x^2)$. We can apply Maxwell's equations, and watch what happens. The Gaussian is the so-called 'generating function' for the infinite set of Hermite polynomials, all of which have very regularly spaced zero crossings. What happens is that the single pulse in E (an even function) generates a double pulse in B (an odd function), which in turn generates a triple pulse in E (another even function), and so on; that is, all the derivatives in play generate successively higher-order Hermite polynomials multiplying the Gaussian. Meanwhile, all the $\mathbf{E} \times \mathbf{B}$ Poynting vectors in play support general spreading of the Gaussian. With each step, the emergent functions look more and more like wavelets, and the individual peaks in the wavelets stay about the same width as more of them accrue, so the wavelength for the emergent wavelet becomes more and more defined. Figure 1 illustrates this behavior at the stage where E has developed five peaks (four zero crossings). Series 1 is the original input Gaussian function, Series 2 is the Gaussian after the overall spreading has developed to this point, and Series 3 is the wavelet that has emerged in the process; *i.e.* the spread-out Gaussian times the fourth-order Hermite polynomial generated.

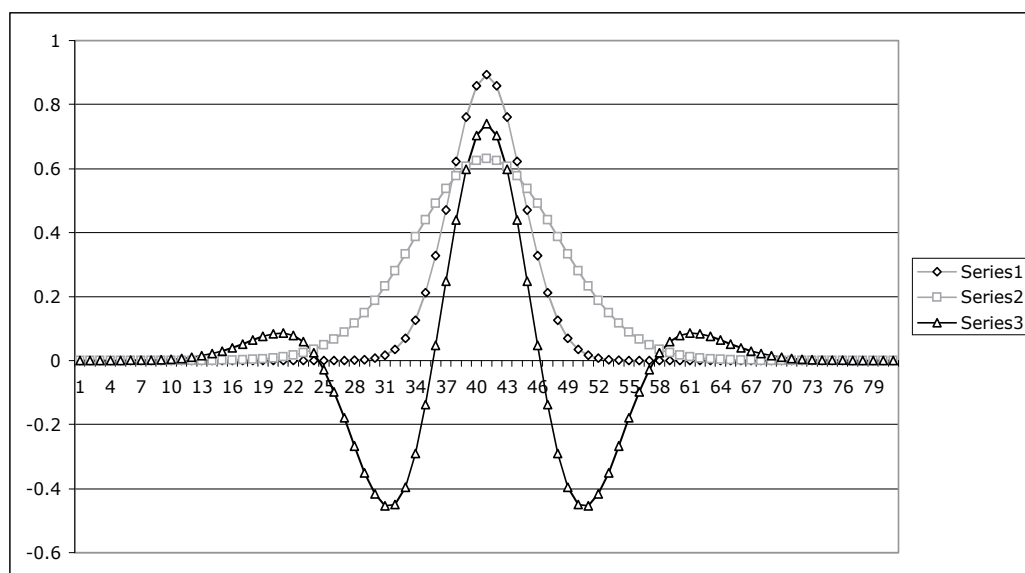

Fig. 1. A wavelet develops when an EM pulse is acted upon by Maxwell's equations.

What we have so far is only one eighth of the story needed to fully represent a photon: development from a pulse into a waveform. We have told the story for one pulse in E . If we would match that with another pulse in B , we would have overall propagation along with waveform development. That would bring us to one quarter of the whole story of the photon. If we would match that with two more pulses, E and B pointing at 90° in space from the first pair and coming 'alive' a quarter cycle out of phase with the first pair, we would have the circular polarization characteristic of photons, but we would still have just half the story. So let us move on, and seek the other half.

2.2 Waveform regression

The remaining half of the story of the photon is about waveform regression. How does this complex structure of four Hermite polynomials multiplied by their generating Gaussian unwind, and go back to being a set of four pulses, so that it can be absorbed into a receiver? Again, let us refer to some similar but more familiar phenomenology:

3. A third phenomenon possible for light modeled as EM waves is 'focusing'. This is what we have optical lenses and shaped mirrors for. It works somewhat contrary to transverse spreading, gathering incident energy into a smaller area transverse to the propagation direction. Of course we don't have any lenses or mirrors in the photon model, but we shall find a mechanism that produces a similar effect.
4. A fourth phenomenon possible for light modeled as EM waves is 'pulse restoration'. This is what transmission lines have 'repeater stations' for. A communication signal degraded by dispersion can be reconstituted when passed through an intelligent filter. Of course we don't have any filters in a photon model, but we shall find a mechanism that produces a similar effect.

The 'similar effect' comes from the imposition of boundary conditions in the longitudinal direction. The Gaussian pulse that was used to describe the waveform development part of the scenario was somewhat unrealistic in that its tails extended to infinity. There is no way that a localized source could emit an energy pulse whose tails would extend to infinity. It is somewhat more realistic to imagine the equivalent of a mirror at the source, and another mirror at the eventual receiver, to confine the waveform like a wave in a box, with zero amplitude at the surface of each mirror and everywhere beyond.

With such boundary conditions imposed, the analytic functions involved in the model are no longer the simple Gaussian and the simple Hermite polynomials that it generates. Now we have not one, but three, Gaussians, the extra two being needed to cancel the first one at the two boundaries. Correspondingly, we always have at least three (actually six) Hermite polynomials alive at any given time. That is a loss of mathematical simplicity. But there is a gain of conceptual simplicity. It is easy to envision that the propagation scenario has some symmetry about its mid point. The waveform will spread until its central peak is halfway between the source and the receiver. After that, the mirror at the receiver will be more significant than the mirror at the source, causing the waveform to start 'piling up' near the receiver, and eventually end up as a pulse near the receiver, similar to the pulse originally launched near the source.

This 'regressing waveform' is somewhat reminiscent of 'advanced' solutions to Maxwell's equations going backwards in time. These were introduced many times in the early 20th century, but particularly popularized in the mid 20th century by Wheeler and Feynman (1945 and 1949).² What we have here is quite different though. There are no differential

² Wheeler and Feynman were looking to time symmetry as the basis for an electromagnetic generalization of instantaneous (Newtonian) gravitational interaction. There are important differences between the regressing waveforms introduced above and the Wheeler-Feynman advanced solutions: 1) Wheeler and Feynman were looking at interactions between essentially point sources and receivers, and so had to be looking at spherically expanding retarded solutions and spherically contracting advanced solutions, not at essentially one-dimensional expanding and contracting wavelets. 2) The Wheeler-Feynman expansion or contraction is related to the spherical area of a wave front, not the waveform in the radial propagation direction. 3) A lengthy discussion of the paradox of advanced actions is necessitated in the Wheeler-Feynman work, whereas the 'regressing' solutions introduced here are not in fact 'advanced' at all; they are just regressing, in real time, in the propagation direction.

equations running backwards in time; there is just 'piling up' of a solution to differential equations in response to a boundary condition.

2.3 The photon model in terms of EM fields

Taken together, the waveform development followed by the waveform regression suggest a photon model in terms of EM fields that exhibits continuous evolution: it goes from a state of pulse-like localization near its source, to a state of wave-like extension in space during its travel, and then back to a state of pulse-like localization near its receiver.

Observe that with this photon model, 'light in flight' develops its wavelength only during its flight. It doesn't have it to start with, and it gives it up at the end. So light at emission, or reception, has a position, but no wavelength, whereas light in flight has a wavelength, but no position. Thus the model expresses a 'wave-particle duality' for light.

Observe too that this photon model exhibits a form of QM 'complementarity', or uncertainty relationship. Consider that, under Fourier transformation, Gaussians map into Gaussians, and that the product of the spreads of such Gaussians is a constant. In the process of wave train development, a Gaussian in position space x spreads out, while its corresponding Gaussian in wave number space k sharpens up.

Inasmuch as the discovery of photons was the point of departure for the development of QM, having this photon model expressed in terms of Maxwell fields is a first step in reconciling MED with QM. But there is much more to do, because the bigger problem for MED was not the photon itself, but rather the atom that emitted or absorbed it. It looked as though MED could never explain an atom being stable in its ground state, much less anything about its excited states. To find any reconciliation there, we must move on.

3. EM signals as photons

Every neutral atom contains at least two particles, and generally a lot more. Prior to QM, electromagnetic forces were presumed to hold such a system together, but there was clearly a problem with that understanding.

The simplest atom is the Hydrogen atom, with just one electron circulating about a nucleus consisting of just one proton. So consider the Hydrogen atom. The electron circulates and so accelerates, and that must generate radiation. It was assumed that this radiation would rob the atomic system of energy, and thereby cause the collapse of the atom.

So it was assumed that Maxwell's EMT is simply incompatible with the stability of atoms. The solution then was to postulate the existence of a different regime of physics in which that wouldn't happen. But was that really necessary? The purpose of this Section is to argue that it was not.

The underlying belief in inevitability of atomic collapse reflects a belief that the electrodynamic forces within the atom are essentially central, and therefore cannot affect the energy budget of the atom. This latter belief traces to the turn of the 20th century, when A. Liénard (1898) and E. Wiechert (1901) developed models for the potentials and fields created by rapidly moving charges. Although Liénard and Wiechert worked independently, they made the same assumption, and they got the same results, and so confirmed each other. This Section looks at those results, and thereby develops a motivation to look back at their underlying assumption.

3.1 Standard formulae for scalar and vector potentials

Expressed in Gaussian units, the Liénard-Wiechert (LW) scalar and vector potentials at position \mathbf{r} and time t are

$$\Phi(\mathbf{r}, t) = e \left[1 / \kappa R \right]_{\text{retarded}} \quad \text{and} \quad \mathbf{A}(\mathbf{r}, t) = e \left[\vec{\beta} / \kappa R \right]_{\text{retarded}} \quad (1)$$

where $\kappa = 1 - \mathbf{n} \cdot \vec{\beta}$, $\vec{\beta}$ is source velocity normalized by c , and $\mathbf{n} = \mathbf{R} / R$ (a unit vector), and $\mathbf{R} = \mathbf{r}_{\text{source}}(t - R/c) - \mathbf{r}$ (an implicit definition for the terminology 'retarded'). The LW fields obtained from those potentials are then

$$\mathbf{E}(\mathbf{x}, t) = e \left[\frac{(\mathbf{n} - \vec{\beta})(1 - \beta^2)}{\kappa^3 R^2} + \frac{\mathbf{n}}{c \kappa^3 R} \times \left((\mathbf{n} - \vec{\beta}) \times \frac{d\vec{\beta}}{dt} \right) \right]_{\text{retarded}} \quad \text{and} \quad \mathbf{B}(\mathbf{r}, t) = \mathbf{n}_{\text{retarded}} \times \mathbf{E}(\mathbf{r}, t) \quad (2)$$

The LW fields have some interesting properties. The $1/R$ fields are radiation fields, and they make a Poynting vector (energy flow per unit area per unit time) that lies along $\mathbf{n}_{\text{retarded}}$:

$$\mathbf{P} = \frac{c}{4\pi} \mathbf{E}_{\text{radiative}} \times \mathbf{B}_{\text{radiative}} = \frac{c}{4\pi} \mathbf{E}_{\text{radiative}} \times (\mathbf{n}_{\text{retarded}} \times \mathbf{E}_{\text{radiative}}) = \frac{c}{4\pi} (E_{\text{radiative}})^2 \mathbf{n}_{\text{retarded}} \quad (3)$$

But the $1/R^2$ fields are Coulomb-Ampère fields, and the Coulomb field does *not* lie along $\mathbf{n}_{\text{retarded}}$ as one might naively expect; instead, it lies along $(\mathbf{n} - \vec{\beta})_{\text{retarded}}$. Assume that $\vec{\beta}$ does not change much over the total field propagation time, in which case $(\mathbf{n} - \vec{\beta})_{\text{retarded}}$ is virtually indistinguishable from $\mathbf{n}_{\text{present}}$. So then the Coulomb field and the radiation are arriving to the observer from different directions.

One can feel moved to check this surprising result. Fortunately, one can look up the original sources, obtain translations if necessary, and verify the original algebra. There is no problem with the algebra. There are also numerous re-derivations that use more modern techniques involving the Dirac delta function and the Heaviside step function. These are 'generalized' functions of some parameter that, when driven to infinity, produces an infinite pulse or a unit step. One can study these re-derivations too. One finds various re-orderings of the mathematical operators 'differentiate', 'integrate', and 'go to parameter limit'. These re-orderings are dodgy because the generalized functions lack the mathematical property of uniform convergence, so these operations don't necessarily commute; it is possible to change the result by changing operation order. But even so, such findings do not change the fact that the original LW derivations, although pedestrian, were correct.

If a problem exists with this LW result, then there is really only one place where it can arise: in the initial assumption; namely, that electromagnetic fields propagate like bullets shot at speed c . But this is the very *same* assumption that Einstein later formalized as his Second Postulate (1905, 1907). He just called them "signals" rather than "fields".

The LW idea of bullets shot at speed c is the foundation for Special Relativity Theory (SRT). (Indeed, SRT offers one of the modern ways to re-derive the LW results.) But SRT is also the foundation for General Relativity Theory (GRT). SRT and GRT together make one of the two great pillars of 20th century Physics: Relativity Theory (RT). So questioning the LW

assumption is not just questioning the LW results; it is questioning the founding assumption of SRT, and so threatening this whole pillar of 20th century theory.

Many people have just accepted that this is just 'the way things are' with classical field theory, and with SRT, and with all of relativity theory as well. But what if one wanted to describe the same scenarios in a thoroughly modern way, with photons instead of radiation fields, and virtual photons instead of Coulomb-Ampère fields? Could anyone really accept the idea that the real photons and the virtual photons created by the same space-time event would arrive at a detector from different directions?

But one needn't accept any such thing, given the photon model in terms of Maxwell fields developed in Sect. 2. In short, since we have a model for photons in terms of fields, we should be able to reverse engineer a model for fields in terms of photons. So what does the photon model developed in Sect. 2 imply? Observe that the developing wavelet can move at speed c relative to the source, and the regressing wavelet can move at speed c relative to the receiver. Applying this idea can help to modify the LW results appropriately.

3.2 Updated formulae for scalar and vector potentials

Recall that with the photon model developed in terms of Maxwell fields in Sect. 2, the life history of the photon has a symmetry point in the middle. Before the mid point of the propagation scenario, the waveform is developing, and after the mid point of the propagation scenario the waveform is regressing. That makes the mid point very important. So far as the receiver is concerned, nothing that happened before the midpoint affects the signal he receives. The source position and velocity information he receives is determined, not by the specification 'retarded', but rather by the specification 'half retarded'.

With this new specification, the scalar and vector potentials become:

$$\Phi(\mathbf{r}, t) = e[1 / \kappa R]_{\text{half retarded}} \quad \text{and} \quad \mathbf{A}(\mathbf{r}, t) = e[\vec{\beta} / \kappa R]_{\text{half retarded}} \quad (4)$$

The fields become:

$$\mathbf{E}(\mathbf{r}, t) = e \left[\frac{(\mathbf{n} - \vec{\beta})(1 - \beta^2)}{\kappa^3 R^2} + \frac{\mathbf{n}}{c\kappa^3 R} \times \left((\mathbf{n} - \vec{\beta}) \times \frac{d\vec{\beta}}{dt} \right) \right]_{\text{half retarded}} \quad (5)$$

$$\text{and} \quad \mathbf{B}(\mathbf{r}, t) = \mathbf{n}_{\text{half retarded}} \times \mathbf{E}(\mathbf{r}, t)$$

The Poynting vector $\mathbf{P}(\mathbf{r}, t)$ becomes:

$$\begin{aligned} \frac{c}{4\pi} \mathbf{E}_{\text{radiative}} \times \mathbf{B}_{\text{radiative}} &= \frac{c}{4\pi} \mathbf{E}_{\text{radiative}} \times (\mathbf{n}_{\text{half retarded}} \times \mathbf{E}_{\text{radiative}}) \\ &= \frac{c}{4\pi} (E_{\text{radiative}})^2 \mathbf{n}_{\text{half retarded}} \end{aligned} \quad (6)$$

Observe that now the direction of the Coulomb field is $(\mathbf{n} - \vec{\beta})_{\text{half retarded}} \approx (\mathbf{n}_{\text{present}})_{\text{half retarded}} \triangleq \mathbf{n}_{\text{half retarded}}$ and the direction of the Poynting vector is $\mathbf{n}_{\text{half retarded}}$ too. So now, the Coulomb field and the Poynting vector are reconciled to the

same direction. That is the first big gift from the photon model in terms of EM fields given in Sect. 2.

And the gifts of photon model in terms of EM fields go well beyond this rather arcane problem about field direction. The photon model in terms of EM fields eliminates the central mystery of Einstein's SRT: having just *one* light speed relative to however *many* different observers there may be. This is complexity at the level of 'multiplicity', much more daunting than the complexity at the level of the mere 'duality' that is found in modern QM.

4. EM fields within atoms

As noted in Sect. 2, atoms were the really big problem for Maxwell's EMT. Now armed with some new information about EMT, it is appropriate to revisit the problem about atoms. We turn again to Hydrogen. From Sect. 3 can infer that at least two processes go on inside the Hydrogen atom, and we shall discover shortly that there are actually three. Only one is familiar. The other two challenge familiar concepts of 'conservation' that originally grew out of Newtonian mechanics. But electromagnetism is not Newtonian mechanics. In electromagnetic problems, the concepts of momentum and energy 'conservation' have to include the momentum and energy of fields, as well as those of matter. Momentum and energy can both be exchanged between matter and fields. 'Conservation' applies only to the system overall, not to matter alone (nor to fields alone either).

4.1 Energy loss due to far-field radiation

The first process that occurs with the Hydrogen atom is the familiar energy loss from the atom due to far-field radiation. There will be a far-field power radiated (energy loss per unit time) of magnitude

$$P_{\text{radiated}} = \int_{4\pi} |\mathbf{P}| R^2 d\Omega = \int_{4\pi} \frac{c}{4\pi} (E_{\text{radiative}})^2 R^2 d\Omega = \int_{4\pi} \frac{c}{4\pi} \frac{e^2}{c^2 \kappa^6} \left| \mathbf{n} \times \left((\mathbf{n} - \vec{\beta}) \times \frac{d\vec{\beta}}{dt} \right) \right|^2 d\Omega, \quad (7)$$

where Ω means 'solid angle'. Because the full 4π of solid angle captures opposing directions of \mathbf{n} , contributions to the integral from the vector $\vec{\beta}$ visible in the integrand cancel out. Contributions to the integral that come from the dot product $\mathbf{n} \cdot \vec{\beta}$ that is hidden in the κ^6 factor may not be zero at every moment, but they time-average to zero. So let us simplify the expression for far-field power radiated by setting $\vec{\beta}$ to zero. We have:

$$P_{\text{radiated}} = \frac{e^2}{4\pi c} \int_{4\pi} \left| \mathbf{n} \times \left(\mathbf{n} \times \frac{d\vec{\beta}}{dt} \right) \right|^2 d\Omega, \quad (8)$$

It evaluates to the well-known Larmor result:

$$\begin{aligned} P_{\text{radiated}} &= \frac{e^2}{4\pi c} \int_{-1}^1 d\cos\theta \int_0^{2\pi} d\phi \left| \frac{d\vec{\beta}}{dt} \right|^2 \sin^2\theta = \frac{e^2}{2c} \left| \frac{d\vec{\beta}}{dt} \right|^2 \int_{-1}^1 d\cos\theta (1 - \cos^2\theta) \\ &= \frac{e^2}{2c} \left| \frac{d\vec{\beta}}{dt} \right|^2 \left(\cos\theta - \frac{1}{3} \cos^3\theta \right) \Big|_{-1}^1 = \frac{2e^2}{3c} \left| \frac{d\vec{\beta}}{dt} \right|^2 \end{aligned} \quad (9)$$

4.2 Energy gain due to internal torquing

The second process that occurs in the Hydrogen atom is a not previously noticed energy gain due to internal torquing. This process occurs because the Coulomb force within the atom is not central; it is along $\mathbf{n}_{\text{half retarded}}$, and not along $(\mathbf{n} - \vec{\beta})_{\text{retarded}} \approx \mathbf{n}_{\text{present}}$.

The power inflow to the electron is $P_{\text{torquing}} = T_e \Omega_e$, where Ω_e is the electron orbit frequency, and T_e is the magnitude of the torque on the electron, given by $\mathbf{T}_e = \mathbf{r}_e \times \mathbf{F}_e$ where \mathbf{r}_e is the electron orbit radius, and \mathbf{F}_e is the tangential force on the electron. But that is not all. The proton also orbits at frequency Ω_e , and experiences its own torque, given by $\mathbf{T}_p = \mathbf{r}_p \times \mathbf{F}_p$, where \mathbf{r}_p is the proton orbit radius (tiny) and \mathbf{F}_p is the tangential force on the proton (huge), with the result that the magnitude T_p is the same as T_e . The total torque on the system is $T = T_e + T_p = 2T_e$. It is determined by the angle between \mathbf{r}_e and \mathbf{F}_e , which is given by $r_p \Omega_e / 2c = (m_e / m_p) r_e \Omega_e / 2c$. So torque $T = (m_e / m_p) (r_e \Omega_e / c) e^2 / (r_e + r_p)$ and power received is

$$P_{\text{torquing}} = \frac{m_e}{m_p} \frac{r_e \Omega_e^2}{c} \frac{e^2}{(r_e + r_p)} = (e^4 / m_p) / c (r_e + r_p)^3. \quad (10)$$

The existence of such a process is why the concept of 'balance' emerges: there can be a balance between gain of energy due to internal torquing and the inevitable loss of energy due to radiation. But we are not done with radiation yet.

4.3 Extra radiation due to Thomas rotation

The fact that the electron and the proton have such different masses, and orbit at such different radii, means that the EM forces within the atom are not only not central; they are not even balanced. This situation has another major implications: The system as a whole experiences a **net force**. That means the system center of mass (C of M) can **move**. This sort of effect does not occur in Newtonian mechanics due to the fact that Newtonian mechanics assumes infinite signal propagation speed.

Looking in more detail, the unbalanced forces in the Hydrogen atom must cause the C of M of the whole atom to traverse its own circular orbit, on top of the orbits of the electron and proton individually. This is an additional source of accelerations, and hence of radiation. It evidently makes even *worse* the original problem of putative energy loss by radiation that prompted the development of QM. But on the other hand, the torque on the system is a candidate mechanism to compensate the rate of energy loss due to radiation, even if there is a lot more radiation than originally thought..

The details are worked out quantitatively as follows. First ask what the circulation can do to the radiation. Some 20 years after the advent of SRT, a relevant kinematic truth about systems traversing circular paths was uncovered by L.H. Thomas (1927), in connection with explaining the then anomalous magnetic moment of the electron: 1/2 its expected value. He showed that a coordinate frame attached to a particle driven around a circle naturally rotates at half the imposed circular revolution rate.

Applied to the scenario of the electron orbiting the proton, the gradually rotating x, y coordinate frame of the electron means that the electron sees the proton moving only half as fast as an external observer would see it. That fact explained the electron's anomalous magnetic moment, and so was received with great interest in its day. But the fact of Thomas rotation has since slipped to the status of mere curiosity, because Dirac theory has replaced

it as the favored explanation for the magnetic moment problem. Now, however, there is a *new* problem in which to consider Thomas rotation: the case of the C of M of a whole Hydrogen atom being driven in a circle by unbalanced forces. In this scenario, the gradually rotating local x, y coordinate frame of the C of M means that the atom system doing its internal orbiting at frequency Ω_e relative to the C of M will be judged by an external observer to be orbiting *twice* as fast, at frequency $\Omega' = 2\Omega_e$ relative to inertial space. This perhaps surprising result can be established in at least three ways: **1)** by analogy to the old electron-magnetic-moment problem; **2)** by construction from Ω_e in the C of M system as the power series $\Omega' = \Omega_e \times (1 + \frac{1}{2} + \frac{1}{4} + \frac{1}{8} + \dots) \rightarrow \Omega_e \times 2$; **3)** by observation that in inertial space Ω' must satisfy the algebraic relation $\Omega' = \Omega_e + \frac{1}{2}\Omega'$, which implies $\Omega' = 2\Omega_e$.

The relation $\Omega' = 2\Omega_e$ means the far field radiation power, if it really ever manifested itself in the far field, would be even *stronger* than classically predicted. The classical Larmor formula for radiation power from a charge e (e in electrostatic units) is $P = 2e^2 a^2 / 3c^3$, where a is total acceleration. For the classical electron-proton system, most of the radiation would be from the electron, orbiting with $a_e = r_e \Omega_e^2$, Ω_e given by the Coulomb force $m_e r_e \Omega_e^2 = F_e = e^2 / (r_e + r_p)^2$. But with $\Omega' = 2\Omega_e$, the effective total acceleration is $a' = a_e \times 2^2$. The total radiation power is then

$$P_{\text{total radiated}} = \frac{2^4}{3c^3} \frac{2e^2}{3c^3} a_e^2 = \left(\frac{2^5 e^6}{m_e^2} \right) / 3c^3 (r_e + r_p)^4. \quad (11)$$

Now posit a balance between the energy gain rate due to the torque and the energy loss rate due to the radiation. The balance requires $P_{\text{torquing}} = P_{\text{total radiated}}$, or

$$(e^4 / m_p) / c (r_e + r_p)^3 = (2^5 e^6 / m_e^2) / 3c^3 (r_e + r_p)^4. \quad (12)$$

This equation can be solved for

$$r_e + r_p = 32m_p e^2 / 3m_e^2 c^2 = 5.5 \times 10^{-9}. \quad (13)$$

Compare that value to the accepted value $r_e + r_p = 5.28 \times 10^{-9}$ cm. The match is fairly close, running just about 4% high. That means the concept of torque *vs.* radiation does a fairly good job predicting the ground state of Hydrogen.

4.4 Unification of physics via Planck's constant

In conventional QM, $r_e + r_p$ is expressed in terms of Planck's constant h , which is presumed to be a fundamental constant of Nature:

$$r_e + r_p = \hbar^2 / 4\pi^2 \mu e^2. \quad (14)$$

Here μ is the so-called 'reduced mass', defined by $\mu^{-1} = m_e^{-1} + m_p^{-1}$, which makes $\mu \approx m_e$. Using that approximation and equating the two expressions (13) and (14) for $r_e + r_p$ implies

$$h \approx \frac{\pi e^2}{c} \sqrt{128m_p / 3m_e}. \quad (15)$$

This expression comes to a value of 6.77×10^{-34} Joule-sec, about 2% high compared to the accepted value of 6.626176×10^{-34} Joule-sec. This reasonable degree of closeness suggests that Planck's constant may reasonably be considered a possible function of other fundamental constants of Nature, and so not itself an independent fundamental constant of Nature. Or the situation may reasonably be considered the other way around: that some other fundamental constant of Nature is really a function of Planck's constant. Either way, we would have one less independent fundamental constant of Nature, and that would mean one more degree of unification among the different branches of physics.

But of course, the expression for h developed here can fulfill such aspirations only if the theory being developed can do a great deal more than just match the ground state of Hydrogen. Worthy targets for additional work include: anticipating the story for isotopes of Hydrogen, anticipating from there what happens with other elements, explaining the excited states of Hydrogen and their resulting spectral lines, anticipating from there the spectral features of some other elements, and characterizing the behavior of the full database on ionization potentials of all elements, and much more. It all constitutes a developing research area that I refer to as 'Algebraic Chemistry'.

5. Extensions and extrapolations from hydrogen

5.1 Larger nuclear mass

The negative energy of the electron in the ground state of the Hydrogen is

$$e^2/(r_e + r_p) = 3c^2 m_e^2 / 2^5 m_p. \quad (16)$$

This is the energy that would have to be provided to liberate the electron, or ionize the atom: the 'ionization potential'.

Eq. (16) provides the basis from which to build corresponding expressions for other entities. For example, the extension to Deuterium and/or Tritium requires that the proton mass m_p be replaced with a more generic nuclear mass M , and that r_p be replaced by r_M . Then we have for the ionization potential of this more massive system:

$$e^2/(r_e + r_M) = 3c^2 m_e^2 / 2^5 M. \quad (17)$$

5.2 Arbitrary nuclear charge

The extension of the model to a neutral atom with nuclear charge number Z involves Z electrons as well. To develop the mathematical model, we must return to the expressions for P_{torquing} and $P_{\text{total radiated}}$, Eqs. (10) and (11). All the factors of e^2 change to $Z^2 e^2$, and the factor of m_e^2 changes to $Z^2 m_e^2$. The equality $P_{\text{torquing}} = P_{\text{total radiated}}$ becomes $Z^4 P_{\text{torquing}} = (Z^6 / Z^2) P_{\text{total radiated}} = Z^4 P_{\text{total radiated}}$. So nothing happens to the equality between P_{torquing} and $P_{\text{total radiated}}$, Eq. (12). But for the more charged system, the energy Eq. (17) becomes

$$Z^2 e^2 / (r_e + r_p) = Z^2 3c^2 m_e^2 / 2^5 M. \quad (18)$$

This scaled-up expression represents the magnitude of the *total* ionization potential of the system involving Z protons and Z electrons. What is then comparable to the ionization potential for removing a *single* electron is:

$$Ze^2/(r_e + r_M) = Z \times (3c^2 m_e^2 / 2^5 M) \equiv (Z/M) \times (3c^2 m_e^2 / 2^5). \quad (19)$$

Thus in the math we find a Z/M scaling law. What do we find in the actual data? Something *much* more complicated, and indeed *so* complicated that we would be unlikely ever to figure it out without the clue that Z/M is part of the story. The involvement of M means the involvement of isotopes, and unwanted complexity. So the clue tells us to look at ionization potentials, not in raw form, but scaled by M/Z , to remove the Z/M factor that the math anticipates.

Figure 2 shows the pattern found. Seven orders of ionization are included. There is a fascinating, but lengthy, story about ionization orders 2 and up; see Whitney (2012). The part of it that will be most important for the present development is obvious from Fig. 2: the energy required to completely strip the atom scales with Z^2 .

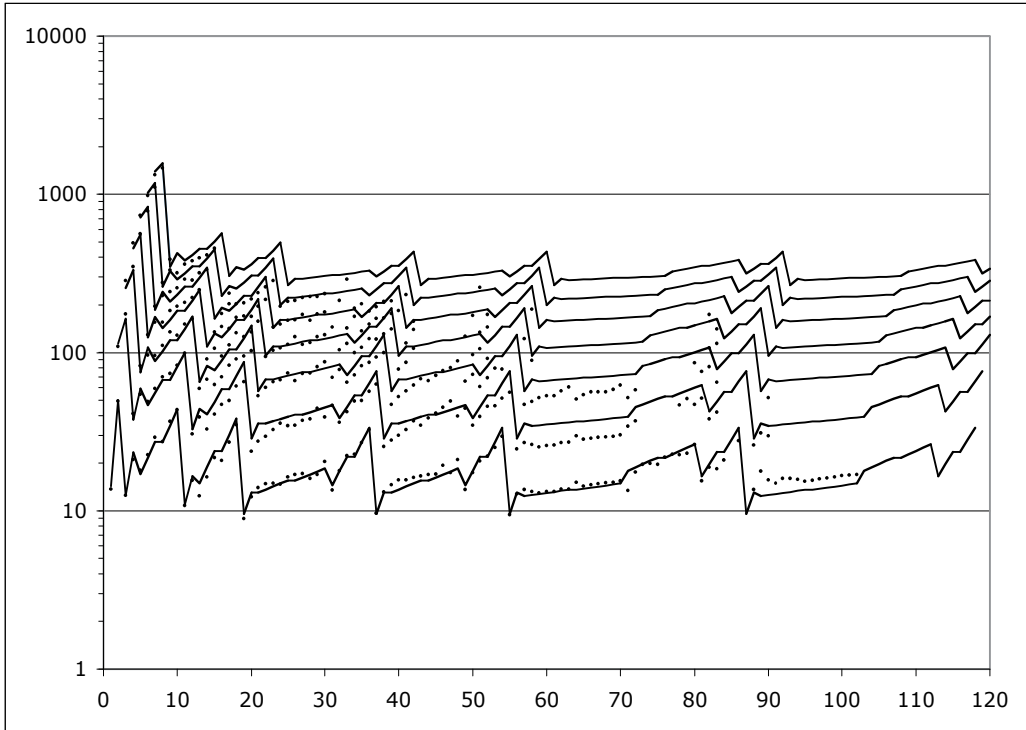

Fig. 2. Ionization potentials, scaled by M/Z and modeled algebraically.

With their M/Z scaling, all of the IP 's can be represented in terms of a baseline value equal to that of Hydrogen, $IP_{1,1}$, and an increment $\Delta IP_{1,Z}$. The increment arises from interactions just between the electrons, quite apart from the nucleus. The electron-on-electron increments are very regular in their behavior. First of all, every period exhibits a

general rise, and by the same factor of $7/2$. Second, there is a general drop from one period to the next, for the first three periods, and all by the same factor of $7/8$.

Then within periods, there is a very regular pattern. There are sub-period rises keyed to the traditional 'angular momentum' quantum number l , and to a non-traditional parameter N that goes $1,2,2,3,3,4,4$ for periods 1 through 7, and gives the number of elements in a period as $2N^2$. For $l \neq 0$, we have:

$$\text{incremental rise} = \text{total rise} \times \text{fraction}, \text{ and } \text{fraction} = \left[(2l + 1) / N^2 \right] \left[(N - l) / l \right]. \quad (20)$$

The following Table details the behavior fractional rises in First-order IP 's over all sub-periods:

period:	N :	l :	fraction:	l :	fraction:	l :	fraction:	l :	fraction:
1	1	0	1						
2	2	0	1/2	1	3/4				
3	2	0	1/3	1	3/4				
4	3	0	1/4	2	5/18	1	2/3		
5	3	0	1/4	2	5/18	1	2/3		
6	4	0	1/4	3	7/48	2	5/16	1	9/16
7	4	0	1/4	3	7/48	2	5/16	1	9/16

The scaled ionization potentials are called IP 's. They are meant to be 'population generic'; that is, the information they contain concerning one element can be applied to a calculation about another element in a different state of ionization, or excitation, by applying the Z/M appropriate for the second element and its state.

5.3 Unequal counts for electrons and protons

Let us first consider ionization sates. These are important for applications in Chemistry, since chemical reactions involve ions. With all this regularity displayed in Fig. 1, it should be possible to use it to help predict the energy budget for all sorts of chemical reactions. We just need a rational way to extrapolate from all the formulae representing the regularities for single electrons being removed from neutral atoms to formulae for electrons being removed from, or added to, ions of all sorts.

Generally, if an atom is in an ionized state, then in place of just Z we have an electron count Z_e distinct from the proton count Z_p . The electron-on-electron interaction does not involve the nucleus, and so always scales with Z_e/M . But electron-nucleus interaction previously represented by $(Z/M)IP_{1,1}$ now has to involve both Z_e and Z_p . We have for the total system

$$Z_p Z_e e^2 / (r_e + r_M) = (Z_p Z_e / M) \times (3c^2 m_e^2 / 2^5). \quad (21)$$

What is then generally comparable to the nuclear-orbit part of the ionization potential for removing a *single* electron? To develop an answer to this question, we must return again to the expressions for P_{torquing} and $P_{\text{total radiated}}$, Eqs. (10) and (11). Clearly, all of the factors of

e^2 change to $Z_p Z_e e^2$. It is as if all factors of e changed to $\sqrt{Z_p Z_e} e$. Removal of one electron is then like removal of one $\sqrt{Z_p Z_e} e$ charge. What is comparable to the ionization potential for removing a single electron from the ion is then

$$\sqrt{Z_p Z_e} e^2 / (r_e + r_M) = \left(\sqrt{Z_p Z_e} / M \right) \times (3c^2 m_e^2 / 2^5). \quad (22)$$

Thus for ions, we see in the math a $\sqrt{Z_p Z_e} / M(Z_p)$ scaling law for that part of the ionization potential that reflects electron-nucleus interaction, $IP_{1,1}$. So for computations we use:

$$IP_{1,1} Z / M \rightarrow IP_{1,1} \sqrt{Z_p Z_e} / M(Z_p). \quad (23)$$

For the other part of the ionization potential, that reflecting just the electron-on-electron interactions, $\Delta IP_{1,Z}$, the relevant Z is Z_e . But the relevant M is still $M(Z_p)$, the only significant mass in the problem. So for computations we use:

$$\Delta IP_{1,Z} Z / M \rightarrow \Delta IP_{1,Z_e} Z_e / M(Z_p). \quad (24)$$

This basic information can help one to model the energy budget for any chemical reaction. To assist readers who want to try this out, the necessary data displayed by Fig. 1 is tabulated in numerical form as Appendix 1 at the end of this Chapter.

Here is one small example. Recall the comment about Fig. 1 that, for nuclear charge $Z = 2$ and up, the energy required to completely strip the atom scales with Z^2 . The actual formula plotted on Fig. 1 goes

$$IP_{Z,Z} = 2IP_{1,1} \times Z^2 = 2 \times 14.250 \times Z^2. \quad (25)$$

The resulting $IP_{Z,Z}$ is population-generic. The corresponding element-specific quantity is $IP_{Z,Z}$ multiplied by the factor $Z / M(Z_p)$. Thus the element-specific energy requirement for total stripping is $2 \times 14.250 \times Z^3 / M(Z_p)$ eV's.

We can now compare the total energy required to strip an atom one electron at a time with the energy required to strip it of its electrons all at once. The two elements Helium and Lithium are good examples because they represent the extremes of very high first-order ionization potential and very low first-order ionization potential. The data for them in numerical form comes from Appendix 1. Here is how the calculations go:

$$\text{Helium: } (Z_p = 2, M(Z_p) = M_2 = 4.003)$$

Write Formulae:

$${}_2\text{He} \rightarrow {}_2\text{He}^+: IP_{1,1} \times 2 / M_2 + \Delta IP_{1,2} \times 2 / M_2; \quad {}_2\text{He}^+ \rightarrow {}_2\text{He}^{++}: IP_{1,1} \times \sqrt{2 \times 1} / M_2.$$

Insert Data:

$${}_2\text{He} \rightarrow {}_2\text{He}^+: 14.250 \times 2 / 4.003 + 35.625 \times 2 / 4.003; \quad {}_2\text{He}^+ \rightarrow {}_2\text{He}^{++}: 14.250 \times 1.4142 / 4.003.$$

Evaluate Formulae:

$${}_2\text{He} \rightarrow {}_2\text{He}^+: 7.1197 + 17.7992 = 24.9189; \quad {}_2\text{He}^+ \rightarrow {}_2\text{He}^{++}: 5.0343.$$

Evaluate Total Stripping One-at-a-Time:

$${}_2\text{He} \rightarrow {}_2\text{He}^{++}: 24.9189 + 5.0343 = 29.9532 \text{ eV's.}$$

Compare to Total Stripping All-at-Once:

$$2 \times 14.250 \times Z^3 / M(Z_p) = 2 \times 14.250 \times 2^3 / M_2 = 2 \times 14.250 \times 2^3 / 4.003 = 56.957 \text{ eV's.}$$

$$\text{Lithium: } (Z_p = 3, M(Z_p) = M_3 = 6.941)$$

Write Formulae:

$${}_3\text{Li} \rightarrow {}_3\text{Li}^+: IP_{1,1} \times 3 / M_3 + \Delta IP_{1,3} \times 3 / M_3 - \Delta IP_{1,2} \times 2 / M_3;$$

$${}_3\text{Li}^+ \rightarrow {}_3\text{Li}^{++}: IP_{1,1} \times \sqrt{3 \times 2} / M_3 + \Delta IP_{1,2} \times 2 / M_3; \quad {}_3\text{Li}^{++} \rightarrow {}_3\text{Li}^{3+}: IP_{1,1} \times \sqrt{3 \times 1} / M_3 .$$

Insert Data:

$${}_3\text{Li} \rightarrow {}_3\text{Li}^+: 14.250 \times 3 / 6.941 + (-1.781) \times 3 / 6.941 - 35.625 \times 2 / 6.941;$$

$${}_3\text{Li}^+ \rightarrow {}_3\text{Li}^{++}: 14.250 \times 2.449 / 6.941 + 35.625 \times 2 / 6.941; \quad {}_3\text{Li}^{++} \rightarrow {}_3\text{Li}^{3+}: 14.250 \times 1.7321 / 6.941 .$$

Evaluate Formulae:

$${}_3\text{Li} \rightarrow {}_3\text{Li}^+: 6.1591 + -0.7698 - 10.2651 = -4.8758;$$

$${}_3\text{Li}^+ \rightarrow {}_3\text{Li}^{++}: 5.0278 + 10.2651 = 15.2929; \quad {}_3\text{Li}^{++} \rightarrow {}_3\text{Li}^{3+}: 3.5560 .$$

Evaluate Total Stripping One-at-a-Time:

$${}_3\text{Li} \rightarrow {}_3\text{Li}^{3+}: -4.8758 + 15.2929 + 3.5560 = 13.9731 \text{ eV's.}$$

Compare to Total Stripping All-at-Once:

$$2 \times 14.250 \times 3^3 / M(Z_3) = 2 \times 14.250 \times 3^3 / M_3 = 2 \times 14.250 \times 3^3 / 6.941 = 110.8630 \text{ eV's.}$$

In these two examples, we see that removal of all the electrons, all at once, takes much more energy than removing the electrons one electron at a time. It is plain to see that total stripping all-at-once is a vigorous, even violent, event. It is the stuff of special-purpose laboratory or field investigation. By contrast, total stripping one-at-a-time is a gentle process. The one-at-a-time process is an example of the stuff of ordinary production Chemistry.

5.4 Excited states - hydrogen

Now let us begin to consider excitation states. These are key for understanding emission or absorption spectra, a fabulously rich source of data about atoms. But atomic spectra are complicated. The standard way to begin to understand them is mathematically, from the family of solutions provided by the differential equation that Schrödinger postulated for the abstract wave function characterizing the electron in the Hydrogen atom.

The standard QM view is that the Hydrogen atom has multiple 'stable states', each with negative energy, $-E$, determined largely by a principle quantum number $n = 1, 2, 3, \dots, \infty$ according to $-E_n \approx -E_1 / n^2$. The idea is that the electron can reside in an upper state ($n > 1$), but only rather precariously, and when it teeters and falls back to the ground state ($n = 1$), a photon is emitted.

But the Hydrogen atom has only two constituent particles, the electron and the proton, and thus very few classical degrees of freedom. That fact makes it difficult to imagine an infinite multiplicity of different 'states' that a Hydrogen atom could exhibit. We are left to ponder a mystery of mathematical QM. So it is tempting to try to develop an additional, more immediately physical, way of understanding the spectral complexity that we see. Consider the possibility that individual Hydrogen atoms may not, by themselves, actually have excited states. Instead, the term 'excited state' may be better applied to a system that involves several Hydrogen atoms.

Key to this idea is that charges can form entities called 'charge clusters'. [Concerning charge clusters at the macro scale of laboratory experiments and field observations: see, for example, Beckmann (1990), Aspden (1990), Piestrup and Puthoff (1998).]

Evidence concerning the probable existence of charge clusters at the micro scale of atoms is plainly visible in the data on IP 's (Fig. 1): some electron counts are very stable and hard to break apart (*e.g.* noble gasses), while some electron counts are very un-stable and hard to keep together (*e.g.* alkali metals). Why would electron counts matter so much if the electrons were not in deep relationships with each other?

But how can electrons outwit electrostatic repulsion? Once given the clue that they evidently *can* do this, it becomes possible to imagine *how* they might do it. The key is that electrostatic repulsion dominates in a static situation. In a dynamic situation, electrons may move at speeds exceeding light speed (Remember, Sect. 3 cast doubt on the founding postulate of SRT, and SRT is all there is to forbid superluminal speeds.). If so, a repulsion signal from one electron may reach another electron only by the time the first electron has moved so much that the repulsion from its 'then' position has become the attraction to its 'now' position. In fact, multiple electrons can form circulating ring structures that are quite stable (for details, see Whitney 2012).

So consider the possibility that an excited state of Hydrogen is actually n_H neutral Hydrogen atoms, with the n_H electrons in a negative charge cluster, and the n_H protons in a positive charge cluster, making a kind of 'super' Hydrogen atom; *i.e.*, Hydrogen with every factor of electron mass m_e , proton mass m_p and charge e scaled by n_H . The torquing power $P_T = (e^4 / m_p c) / (r_e + r_p)^3$ then scales by $(n_H)^4 / n_H = (n_H)^3$, and the radiation power $P_R = 2^5 e^6 / 3c^3 (m_e)^2 (r_e + r_p)^4$ scales by $(n_H)^6 / (n_H)^2 = (n_H)^4$. The solution for system radius $r_e + r_p = 32m_p e^2 / 3(m_e)^2 c^2$ then becomes:

$$r_{n_H e} + r_{n_H p} = 32(n_H m_p)(n_H e)^2 / 3(n_H m_e)^2 c^2 = n_H (r_e + r_p). \quad (26)$$

i.e., the system radius is scales with n_H . The system orbital energy

$$E_1 = -\frac{1}{2} \frac{e^2}{(r_e + r_p)} = -\frac{1}{2} e^2 \times 3(m_e)^2 c^2 / 32m_p e^2 \text{ becomes}$$

$$E_{n_H} = -\frac{1}{2} \frac{(n_H)^2}{n_H} \frac{e^2}{(r_e + r_p)} = -\frac{1}{2} n_H \left[e^2 \times 3(m_e)^2 c^2 / 32 m_p e^2 \right]. \quad (27)$$

i.e., the system orbital energy also scales with n_H . This result is the same as if the atoms were isolated, instead of being organized into a big system with two charge clusters. This suggests that the energy available for generating photons by de-excitation isn't 'orbital' at all, but is instead the energy tied up in forming the charge clusters out of the multiple electrons and the multiple protons from the multiple Hydrogen atoms.

What can we infer about such charge clusters? As in the modeling of IP 's for ions, we can again consider Fig. 1 as a source of information about electron clusters of sizes up to 118, quite apart from the particular element that the information is located with. From Fig. 1, It is clear that most of the ΔIP 's are positive, meaning their electron clusters are hard to break. So despite being made of same-sign charges, most of them exist in negative energy states. The ones that are particularly hard to break are the ones associated with the noble gasses: $Z = 2, 10, 18, 36, 54, 86, (118)$. These elements are at the ends of periods on the periodic table, and the lengths of the periods themselves are: $2, 8, 8, 18, 18, 32, (32)$. (Parentheses mean we haven't discovered, or created, that element yet.) The implication is that excited states of Hydrogen existing in the form of 'super Hydrogen' would most frequently exist with $n_H = 2, 8, 18, 32, \dots$

Can we anticipate what would happen when any such excited state de-excites? Suppose we started with $n_H = 32$. It could, for example, decompose into 18, 8, 2, 2, and 1, 1; *i.e.* some less excited states and a couple of ground-state atoms; 6 daughter systems in all. Suppose that for every such daughter produced, there is a photon released. Exactly how might that work? Observe that four daughters are in states that are even more negative than the starting state, so those are no problem. But two daughters are in the ground states, which is not more negative than the starting state. So energy from the other daughters has to be enlisted to create any photons there.

For any n_H , there may be a de-excitation path, or paths, for which the energy budget is insufficient, in which case those paths won't be taken. There may also be de-excitation paths for which the energy budget is more than sufficient, in which case there will be, not only spectral radiation, but also a bit of heat radiation. Very rarely, there might be a de-excitation path for which the energy budget is just exactly right.

The spectral lines that occur with Hydrogen (or any element) are typically characterized in part by differences in inverse square integers. The integers involved are traditionally understood in terms of the familiar radial quantum number n . Is it possible to understand them also in terms of the n_H used here?

Recall that if one then chooses to model the behavior of Hydrogen 'excitation' in terms of a single Hydrogen atom with discrete radial states identified with the radial quantum number n , then the orbit-radius scaling has to be the quadratic scaling $r_1 \rightarrow r_n = n^2 r_1$ of standard QM, not the linear orbit-radius scaling $r_e + r_p \rightarrow r_{n_H} = n_H (r_e + r_p)$ of the present model. So why does one way of looking at the problem involve a quadratic n^2 , while the other way of looking at it involves a linear n_H ?

Recall that there was good reason to suggest highest probability for the values $n_H = 2, 8, 18, 32, \dots$ corresponding to the lengths of the rows in the Periodic Table. These row lengths can be characterized as $2N^2$ for $N = 1, 2, 2, 3, 3, 4, (4)$. So n_H actually does encode something that is quadratic, namely the N^2 , and is therefore similar to the quadratic n^2 .

5.5 Beyond both hydrogen and ground states: Spectroscopy

In spectroscopy, we observe light created when an atomic system relaxes in some way. For elements beyond Hydrogen, the spectral lines that occur are often characterized in part by the so-called Rydberg factor:

$$R_\infty = \frac{2\pi^2 m_e e^4}{ch^3} \frac{Z^2}{1 + m_e / M}. \quad (28)$$

The R_∞ is traditionally interpreted as the energy needed for total removal of one electron from the ground state to infinity, leaving an ion. The energy needed for an electron to get from a state labeled n_1 to a higher state labeled $n_2 > n_1$, and conversely the energy released when it goes back to n_1 , is then modeled as

$$\Delta E = R_\infty \left[1 / (n_1)^2 - 1 / (n_2)^2 \right]. \quad (29)$$

Observe that R_∞ contains a factor of Z^2 , just like the IP 's for total ionization, $IP_{Z,Z}$ of Eq. (25) do. That means R_∞ is referring to the absolutely largest photon energy that the system could ever possibly be imagined deliver: starting from a state of total ionization, *i.e.* a naked nucleus, and having the entire electron population return in one fell swoop, with the emission of just one photon for the whole job. That scenario could never actually happen. One-at-a-time electron return is the only plausible return scenario. The inverse square integers in the square bracket bring ΔE down to values appropriate for one-at-a-time scenarios.

Observe that the Rydberg model for spectral lines already conflicts with an older model for the atom developed from the PT; *i.e.*, electron 'shells' enclosing the nucleus, inner shells filled, and at most one outer shell unfilled; partially filled for most elements, and completely filled for noble gasses. The older PT-based model suggests shielding of the nucleus by the filled inner shells of electrons. But the occurrence of a Z^2 in R_∞ , even for large n_1 and n_2 in ΔE , means there is no shielding of the nucleus. So electrons must be in tight clusters, rather than nucleus-enclosing shells.

Observe that R_∞ does not contain any Z/M factor like the IP model contains. Instead, it has a factor

$$1/(1 + m_e / M) = M / (M + m_e), \quad (30)$$

which is essentially unity. At the time when R_∞ was formulated, most of the known trans-Hydrogenic elements had $M \approx 2Z$, and the factor of $Z/M \approx 1/2$ could be absorbed into an external constant factor, the $2\pi^2 m_e e^4 / ch^3$ in R_∞ . That is no longer the case today. We know about heavy elements for which $M \rightarrow 2.5Z$, or $Z/M \rightarrow 2/5$. So now it would be better to use the function Z/M instead of the number $1/2$. An extra bonus would be that Hydrogen, with $Z/M = 1$, would be included.

Now consider that spectral lines might *not* to arise from de-ionizing one ion of one atom, but rather from de-exciting a system involving multiple neutral atoms. In this description, the n_1 and n_2 are not identifiers of different states of one atom, but rather numbers of atoms organized into super atoms. Otherwise, nothing really changes. However we interpret their meaning, the predicted spectral lines remain the same.

6. Unification between Newton and Maxwell

This last technical Section of this Chapter returns to the first physics disunity mentioned in the Introduction: the seemingly different coordinate-transformation properties of Newton's Laws for mechanics and Maxwell's equations for electrodynamics. Newton's laws are form invariant under Galilean transformations. But Maxwell's equations are generally thought to be form invariant only under Lorentz transformations. Especially, they are thought to be *not* form invariant under Galilean transformations.

So a curious situation exists within physics today. It is generally expected that the equations of physics should be tensor equations. By definition of the word 'tensor', a tensor equation is form invariant under arbitrary changes of reference frame, assuming no singularities or other cruel and unusual circumstances in the transformation or its inverse transformation. That means a tensor equation should be form invariant under arbitrary, though reasonably well-behaved, space-time transformations.

So, are Maxwell's equations *really* tensor equations? Or not? Mathematicians have good reason to challenge the believed tensor status of Maxwell's equations, while physicists have good reason to challenge the believed requirement for invariance under anything other than Lorentz transformation. But the situation is not generally acknowledged. It is the proverbial 'elephant in the living room'.

Clarifying this situation can assist physics in becoming more unified from its beginning to its present. And mathematics has lots of applicable tools; see Kiein (2009). The present work offers an approach that is also mathematical, but a lot more elementary. Maybe it will communicate to different readers.

The problem, I believe, is of a type with which QM has some history. QM appears to be the first branch of physics that well and truly needed complex numbers. They may have been used in physics before QM, but they were only one of the tools available for the problems then at hand. Sines and cosines could generally handle any problem just as well as complex exponentials could handle it. But with QM, complex exponentials became truly essential for doing physics.

The history of mathematics has been a tale of increasing range of objects included in the discussion. It began with real, positive integers; it grew with the inclusion of zero and negative integers, and grew again with the inclusion of all rational numbers, and again with the inclusion of all irrational numbers. Then it grew with the inclusion of imaginary numbers, thus creating complex numbers. This was the first of a number of 'doublings' of the number of dimensions attributed to mathematical objects. [See Rowlands (2007).] After complex numbers, we got quaternions, and bi-quaternions, or octonians, and there is no reason to suppose that further doublings will not continue to prove useful.

Complex numbers make possible operations that are not possible without them. Consider, for example, the square root of -3 . It cannot be evaluated within the real number system, but in the complex number system, it is just $\pm i\sqrt{3}$.

I believe 'doublings' are generally like this: they make possible operations that were not possible without them. There appears to be today an opportunity for a doubling in the realm of tensor calculus. There are presently exactly two tensor-transformation behaviors identified, called 'contravariant' and 'covariant'. It appears that tensor calculus can be usefully extended through a doubling of the number of transformation behaviors that can be described, from two to four. It appears that such a doubling can resolve the apparent

conflict between Newtonian and Maxwellian physics: it can make possible a display showing how Maxwell's equations can actually be form invariant under arbitrary coordinate transformations.

6.1 The opportunity offered by tensor notation

The display of four transformation behaviors requires the use of four tensor index positions. So in addition to the usual contravariant (index up-right) and covariant (index down-right) positions on the right side of a tensor symbol, we need to use the positions available on the left side: index up-left and index down-left. Since left-side index positions have not been in used in this new way before, they need new names designed for the purpose. To recall the move from right to left, let us use the prefix 'trans'. So let the up-left index position be called 'transcontravariant', and let the down-left index position be called 'transcovariant').

All the transformations are describing what happens to tensor merates when the frame of reference changes; *i.e.* when the basis unit vectors defining the frame of references are replaced with other basis unit vectors. The transformations discussed here are arbitrary within the specifications that make the connections between reference frames reasonably well behaved; the individual relationships are differentiable and reversible, the matrix representations of them are invertible and unimodular.

I mention both tensors and matrices because they are equivalent notation schemes that can be used interchangeably for describing systems of linear equations. Tensor notation is useful for making a compact statement of a whole mathematical situation. Matrix notation is useful for separating a whole mathematical situation into constituent parts for calculations. Individual linear equations are useful for focusing on individual parts of the mathematical problem. Human beings do have strong personal preferences about which approach to use, but all of these approaches should agree on the basic facts of a given situation, so any of these approaches should be acceptable. In the present work, all approaches will be used. That way, everyone can find something to like, and everyone can find something to dislike!

In the case of the matrix displays and the linear equations, the presentation does save a little space by ignoring two spatial dimensions and focusing on one spatial dimension (call it 1) and the temporal dimension (call it 0).

6.2 Transformation of a contravariant object

The most familiar transformation is the contravariant one. The prefix 'contra' means these tensor merates change opposite to the way the basis unit vectors of the reference frame change. For an arbitrary input vector X^α , the transformation reads $\bar{X}^\beta = \left[\partial \bar{x}^\beta / \partial x^\alpha \right] X^\alpha$, where we see the transformation as partial derivatives of coordinates, new with respect to old. Equivalently $\bar{X}^\beta = T_\alpha^\beta X^\alpha$, where we see the transformation written as the tensor T_α^β .

Also equivalently, we have $\begin{bmatrix} \bar{X}^0 \\ \bar{X}^1 \end{bmatrix} = \begin{bmatrix} T_0^0 & T_1^0 \\ T_0^1 & T_1^1 \end{bmatrix} \begin{bmatrix} X^0 \\ X^1 \end{bmatrix}$, where we see everything, the input and

output vectors and the transformation, in matrix format. Or equivalently, we have $\bar{X}^0 = T_0^0 X^0 + T_1^0 X^1$ and $\bar{X}^1 = T_0^1 X^0 + T_1^1 X^1$ as two separate linear equations.

For the contravariant transformation matrix $\begin{bmatrix} T_0^0 & T_1^0 \\ T_0^1 & T_1^1 \end{bmatrix}$ one can define a reverse transformation matrix $\begin{bmatrix} R_0^0 & R_1^0 \\ R_0^1 & R_1^1 \end{bmatrix}$, wherein $R_0^0 = T_0^0$ and $R_1^1 = T_1^1$, but $R_1^0 = -T_1^0$ and $R_0^1 = -T_0^1$. Applied to \bar{X}^β , the reverse transformation R_β^α takes \bar{X}^β back to X^α : $X^\alpha = R_\beta^\alpha \bar{X}^\beta$. That is to say: $X^0 = R_0^0 \bar{X}^0 + R_1^0 \bar{X}^1$ and $X^1 = R_0^1 \bar{X}^0 + R_1^1 \bar{X}^1$. Expressed in matrix form, the reverse transformation is the inverse transformation: $\begin{bmatrix} X^0 \\ X^1 \end{bmatrix} = \begin{bmatrix} R_0^0 & R_1^0 \\ R_0^1 & R_1^1 \end{bmatrix} \begin{bmatrix} \bar{X}^0 \\ \bar{X}^1 \end{bmatrix}$, or $\begin{bmatrix} R_0^0 & R_1^0 \\ R_0^1 & R_1^1 \end{bmatrix} \begin{bmatrix} T_0^0 & T_1^0 \\ T_0^1 & T_1^1 \end{bmatrix} = \begin{bmatrix} 1 & 0 \\ 0 & 1 \end{bmatrix}$. The distinction between the words reverse and inverse is nil in the contravariant context. But it becomes important in the next context.

6.3 Transformation of a covariant object

The prefix 'contra' means reverse to the prefix 'co'. The covariant transformation goes the same way the basis unit vectors change. So the covariant transformation $\bar{X}_\beta = C_\beta^\alpha X_\alpha$ in

matrix format $\begin{bmatrix} \bar{X}_0 \\ \bar{X}_1 \end{bmatrix} = \begin{bmatrix} C_0^0 & C_0^1 \\ C_1^0 & C_1^1 \end{bmatrix} \begin{bmatrix} X_0 \\ X_1 \end{bmatrix}$ uses transformation matrix C equal to the reverse contravariant transformation matrix R : $\begin{bmatrix} \bar{X}_0 \\ \bar{X}_1 \end{bmatrix} = \begin{bmatrix} R_0^0 & R_1^0 \\ R_0^1 & R_1^1 \end{bmatrix} \begin{bmatrix} X_0 \\ X_1 \end{bmatrix}$, or equivalently

$\bar{X}_0 = R_0^0 X_0 + R_1^0 X_1$ and $\bar{X}_1 = R_0^1 X_0 + R_1^1 X_1$. It is generally assumed that this is the same as saying the covariant transformation is the inverse to the contravariant transformation. Notice however that the off-diagonal merates $C_0^1 = R_1^0$, and $C_1^0 = R_0^1$ have indices switched around. This is because C operates on a covariant object, whereas, in its original definition, R operated on a contravariant object.

The index switching makes no difference if we limit attention to transformations that are space-time symmetric, *i.e.* Lorentz transformations. But if we wish to investigate any other type of transformation, we have to investigate whether the switch makes a difference. Consider the inner product $\bar{X}_\beta \bar{X}^\beta$. Under Lorentz transformation, it is preserved, equal to $\bar{X}_\beta \bar{X}^\beta = X_\alpha X^\alpha$. But if we do not have space-time symmetry, is it still preserved? This question has to be answered by testing.

Laying out the problem in matrix format, we have to make one of the vectors, say the covariant one, a row vector, and then we have to test:

$$\begin{bmatrix} \bar{X}_0 & \bar{X}_1 \end{bmatrix} \begin{bmatrix} \bar{X}^0 \\ \bar{X}^1 \end{bmatrix} = \begin{bmatrix} X_0 & X_1 \end{bmatrix} \begin{bmatrix} R_0^0 & R_1^0 \\ R_0^1 & R_1^1 \end{bmatrix} \begin{bmatrix} T_0^0 & T_1^0 \\ T_0^1 & T_1^1 \end{bmatrix} \begin{bmatrix} X^0 \\ X^1 \end{bmatrix} = ? = \begin{bmatrix} X_0 & X_1 \end{bmatrix} \begin{bmatrix} X^0 \\ X^1 \end{bmatrix} \quad (31)$$

Observe that the R matrix is transposed from what it would need to be to make the RT matrix product collapse to the identity. So the inner product $X_\alpha X^\alpha$ is generally *not* preserved if we do not have space-time symmetry.

6.4 Transformations for objects of four types

In order to recover the general availability of preserved inner products, the two additional transformation behaviors are defined. The transcovariant transformation is defined as the transposed inverse of the contravariant one. The transcontravariant transformation is defined as the transposed inverse of the covariant one.

Recall that this discussion began with the contravariant transformation written in the tensor notation $\bar{X}^\beta = [\partial\bar{x}^\beta / \partial x^\alpha] X^\alpha$. The discussion soon became complicated enough to merit introduction of more detailed notation that can clearly distinguish the four cases. The following Table illustrates the expanded tensor notation:

<p>transcontravariant,</p> ${}^\beta \bar{X} = [{}^\beta T_\alpha] {}^\alpha X = [\partial x^\beta / \partial \bar{x}^\alpha]_{\text{reverse}} {}^\alpha X$	<p>contravariant,</p> $\bar{X}^\beta = [T_\alpha^\beta] X^\alpha = [\partial \bar{x}^\beta / \partial x^\alpha]_{\text{direct}} X^\alpha$
<p>transcovariant,</p> ${}_\beta \bar{X} = [{}_\beta C^\alpha] {}_\alpha X = [\partial x^\alpha / \partial \bar{x}^\beta]_{\text{direct}} {}_\alpha X$	<p>covariant,</p> $\bar{X}_\beta = [C_\beta^\alpha] X_\alpha = [\partial \bar{x}^\alpha / \partial x^\beta]_{\text{reverse}} X_\alpha$

The Table is organized for user convenience, with the position of information corresponding to the index position: upper right for contravariant, lower right for covariant, lower left for transcovariant, and upper left for transcontravariant. The index position assigned to an object determines the transformation law that it follows.

Now let two arbitrary numbers with magnitude less than unity be represented by the letters A and B (chosen from the word 'arbitrary!'). Let the arbitrary numbers represent in turn the off-diagonal elements of transformation matrices. The following table shows the corresponding matrix notation:

<p>transcontravariant,</p> $\begin{bmatrix} {}^0\bar{X} \\ {}^1\bar{X} \end{bmatrix} = \frac{1}{\sqrt{1-AB}} \begin{bmatrix} 1 & -A \\ -B & 1 \end{bmatrix} \begin{bmatrix} {}^0X \\ {}^1X \end{bmatrix}$	<p>contravariant,</p> $\begin{bmatrix} \bar{X}^0 \\ \bar{X}^1 \end{bmatrix} = \frac{1}{\sqrt{1-AB}} \begin{bmatrix} 1 & -B \\ -A & 1 \end{bmatrix} \begin{bmatrix} X^0 \\ X^1 \end{bmatrix}$
<p>transcovariant,</p> $\begin{bmatrix} {}_0\bar{X} \\ {}_1\bar{X} \end{bmatrix} = \frac{1}{\sqrt{1-AB}} \begin{bmatrix} 1 & +A \\ +B & 1 \end{bmatrix} \begin{bmatrix} {}_0X \\ {}_1X \end{bmatrix}$	<p>covariant,</p> $\begin{bmatrix} \bar{X}_0 \\ \bar{X}_1 \end{bmatrix} = \frac{1}{\sqrt{1-AB}} \begin{bmatrix} 1 & +B \\ +A & 1 \end{bmatrix} \begin{bmatrix} X_0 \\ X_1 \end{bmatrix}$

Observe that this Table uses negative signs on the arbitrary A and B in the contravariant and transcontravariant cases, positive signs in the covariant and transcovariant cases. This sign choice is used to help recall the prefixes ‘contra’ and ‘co’. Observe too that if $B = A$, we have space-time symmetry, which is the case of Lorentz transformations. And observe finally that if $B = 0$, we have universal time, which is the case of Galilean transformations. But A and B are arbitrary, and so can also represent other transformations as yet unnamed.

6.5 Transformations for invariant objects

The underlying purpose of tensor calculus is to focus on mathematical objects that are ‘coordinate free’, or ‘frame independent’, or ‘invariant’ (whether in form or in numerical value), – all expressions meaning that coordinate transformation does not change anything fundamental about an object so-described: values of scalars, or relationships expressed as equations involving tensors.

The user of tensor calculus expects certain behaviors. There should be number invariant inner products of vectors and of higher-order tensors. The ‘unity’, or ‘Kronecker delta’ is not presently regarded as a real tensor, but can be accepted as one if it can be demonstrated number invariant. Finally, the user will certainly expect a number invariant ‘metric tensor’, the essential tool for manipulating index positions to develop tensor equations. Displaying that all these expectations can be met in the case of arbitrary transformations, not just Lorentz transformations, is the objective of this Sub-Section.

The matrix notation is useful in checking out the transformation of all these entities. For example, the preserved inner product of a vector X with itself looks like (note the transpositions for operating on row vectors):

$${}_{\beta} \bar{X} X^{\beta} = [{}^0\bar{X} \ {}^1\bar{X}] \begin{bmatrix} \bar{X}^0 \\ \bar{X}^1 \end{bmatrix} = [{}^0X \ {}^1X] \frac{1}{1-AB} \begin{bmatrix} 1 & +B \\ +A & 1 \end{bmatrix} [{}^0X \ {}^1X] \begin{bmatrix} 1 & -B \\ -A & 1 \end{bmatrix} \begin{bmatrix} X^0 \\ X^1 \end{bmatrix} = [{}^0X \ {}^1X] \begin{bmatrix} X^0 \\ X^1 \end{bmatrix} = {}_{\alpha} X X^{\alpha}. \quad (32)$$

or

$${}^{\beta}\bar{X}\bar{X}_{\beta} = \begin{bmatrix} {}^0\bar{X} & {}^1\bar{X} \end{bmatrix} \begin{bmatrix} \bar{X}_0 \\ \bar{X}_1 \end{bmatrix} = \begin{bmatrix} {}^0X & {}^1X \end{bmatrix} \frac{1}{1-AB} \begin{bmatrix} 1 & -B \\ -A & 1 \end{bmatrix} \begin{bmatrix} 1 & +B \\ +A & 1 \end{bmatrix} \begin{bmatrix} X_0 \\ X_1 \end{bmatrix} = \begin{bmatrix} {}^0X & {}^1X \end{bmatrix} \begin{bmatrix} X_0 \\ X_1 \end{bmatrix} = {}^{\alpha}X X_{\alpha}. \quad (33)$$

The more familiar inner product $X_{\alpha}X^{\alpha}$ is preserved with Lorentz transformations, but not with arbitrary transformations. So it shouldn't be considered any kind of 'invariant'. The same is true of the unfamiliar $({}_{\alpha}X)({}^{\alpha}X)$.

With the extended tensor notation, we can identify the index positions that definitely make a number invariant Kronecker delta. It looks like (note the transpositions for operating on row vectors):

$$\delta^{\bar{\delta}\gamma} = \frac{1}{1-AB} \begin{bmatrix} 1 & +A \\ +B & 1 \end{bmatrix} \begin{bmatrix} 1 & 0 \\ 0 & 1 \end{bmatrix} \begin{bmatrix} 1 & -A \\ -B & 1 \end{bmatrix} = \begin{bmatrix} 1 & 0 \\ 0 & 1 \end{bmatrix} = \beta\delta^{\alpha}. \quad (34)$$

or

$$\delta_{\bar{\delta}\gamma} = \frac{1}{1-AB} \begin{bmatrix} 1 & -A \\ -B & 1 \end{bmatrix} \begin{bmatrix} 1 & 0 \\ 0 & 1 \end{bmatrix} \begin{bmatrix} 1 & +A \\ +B & 1 \end{bmatrix} = \begin{bmatrix} 1 & 0 \\ 0 & 1 \end{bmatrix} = \beta\delta_{\alpha}. \quad (35)$$

The more familiar δ^{α}_{β} is preserved with Lorentz transformations, but not with arbitrary transformations. That is why it does not qualify as a tensor. The same is true of the unfamiliar ${}^{\alpha}_{\beta}\delta$.

Some readers will be surprised to see the present argument using the Lorentz metric, $\begin{bmatrix} 1 & 0 \\ 0 & -1 \end{bmatrix}$, without accepting a limitation to Lorentz transformations. It is widely supposed

that the Lorentz metric requires Lorentz transformations, and/or Lorentz transformations require the Lorentz metric. But such a connection is not in fact mandatory.

The generally preserved forms of the Lorentz metric tensor look like (note the transpositions for operating on row vectors):

$$\delta^{\bar{g}\gamma} = \frac{1}{1-AB} \begin{bmatrix} 1 & -A \\ -B & 1 \end{bmatrix} \begin{bmatrix} 1 & 0 \\ 0 & -1 \end{bmatrix} \begin{bmatrix} 1 & -A \\ -B & 1 \end{bmatrix} = \frac{1}{1-AB} \begin{bmatrix} 1 & -A \\ -B & 1 \end{bmatrix} \begin{bmatrix} 1 & -A \\ +B & -1 \end{bmatrix} = \begin{bmatrix} 1 & 0 \\ 0 & -1 \end{bmatrix} = \beta g^{\alpha}. \quad (36)$$

and

$$\delta_{\bar{g}\gamma} = \frac{1}{1-AB} \begin{bmatrix} 1 & +A \\ +B & 1 \end{bmatrix} \begin{bmatrix} 1 & 0 \\ 0 & -1 \end{bmatrix} \begin{bmatrix} 1 & +A \\ +B & 1 \end{bmatrix} = \frac{1}{1-AB} \begin{bmatrix} 1 & +A \\ +B & 1 \end{bmatrix} \begin{bmatrix} 1 & +A \\ -B & -1 \end{bmatrix} = \begin{bmatrix} 1 & 0 \\ 0 & -1 \end{bmatrix} = \beta g_{\alpha}. \quad (37)$$

The more familiar $g^{\beta\alpha}$ and $g_{\beta\alpha}$ are preserved with Lorentz transformations, but not with arbitrary transformations. They shouldn't be considered any kind of 'invariant'. The same is true of the unfamiliar ${}^{\beta\alpha}g$ and ${}_{\beta\alpha}g$.

The number invariant ${}^{\alpha}g^{\beta}$ and ${}_{\alpha}g_{\beta}$ can function to raise and lower indices on objects. For example, $X_{\beta} = ({}_{\alpha}g_{\beta})X^{\alpha}$ and $X^{\beta} = ({}^{\alpha}g^{\beta})X_{\alpha}$, or ${}^{\alpha}X = ({}^{\alpha}g^{\beta})({}_{\beta}X)$ and ${}_{\alpha}X = ({}_{\alpha}g_{\beta})({}^{\beta}X)$.

One can also write additional index assignments for g . Altogether, there are 10 possible assignments, as there are $4 \times 3 / 2 = 6$ with indices in different corners, and 4 with indices in the same corner.

Two of the additional index assignments look like ${}_{\beta}g^{\alpha}$ and ${}^{\beta}g_{\alpha}$. These two entities cannot do anything to an index except change its name. For example, $X^{\alpha} = X^{\beta}({}_{\beta}g^{\alpha})$ and $X_{\alpha} = X_{\beta}({}^{\beta}g_{\alpha})$, or ${}_{\beta}X = ({}_{\beta}g^{\alpha})({}_{\alpha}X)$ and ${}^{\beta}X = ({}^{\beta}g_{\alpha})({}^{\alpha}X)$. So ${}_{\beta}g^{\alpha}$ and ${}^{\beta}g_{\alpha}$ are just equivalent to the number invariant ${}_{\beta}\delta^{\alpha}$ and ${}^{\beta}\delta_{\alpha}$ already noted above.

Further additional index assignments on g create entities that can serve to convert a regular index into a trans one, or a trans one into a regular one. None of these entities are number invariant, but in practice, that does not matter. The user does not convert just a single object; the user converts a whole tensor equation. The index-converting g entities typically occur in pairs, and the pairs contract to number invariant objects. When they don't occur in pairs, they do occur on both sides of an equation, and cannot affect the issue of equation form invariance.

Another two of these of g 's are g^{α}_{β} and ${}^{\beta}_{\alpha}g$. They function to do ${}^{\beta}X = ({}^{\beta}_{\alpha}g)X^{\alpha}$ and ${}_{\alpha}X = ({}^{\beta}_{\alpha}g)X_{\beta}$, or $X_{\beta} = g^{\alpha}_{\beta}({}_{\alpha}X)$ and $X^{\alpha} = g^{\alpha}_{\beta}({}^{\beta}X)$. As a pair, they contract to $({}^{\gamma}_{\beta}g)(g^{\alpha}_{\gamma}) = {}_{\beta}g^{\alpha}$, or to $({}^{\beta}_{\gamma}g)(g^{\gamma}_{\alpha}) = {}^{\beta}g_{\alpha}$, both of which are number invariant.

The final four indexed g 's are ${}^{\alpha\beta}g$, ${}_{\alpha\beta}g$, $g^{\alpha\beta}$, and $g_{\alpha\beta}$. They can all function to change a regular index into a trans one, or a trans one into a regular one, but with a twist: 'co' goes to 'contra', or 'contra' goes to 'co'. That is, ${}^{\alpha}X' = ({}^{\alpha\beta}g)X_{\beta}$, ${}_{\alpha}X = ({}_{\alpha\beta}g)X^{\beta}$, $g^{\alpha\beta}({}_{\alpha}X) = X^{\beta}$ and $g_{\alpha\beta}({}^{\alpha}X) = X_{\beta}$. As noted above, the contractions $({}_{\beta\gamma}g)(g^{\gamma\alpha}) = {}_{\beta}g^{\alpha}$ and $({}^{\beta\gamma}g)(g_{\gamma\alpha}) = {}^{\beta}g_{\alpha}$ are number invariant.

The bottom line is this: to be sure of invariance under arbitrary transformation, not just Lorentz transformation, always contract a regular index with a trans index.

6.6 General invariance for Maxwell's equations

Maxwell's equations in current tensor notation read:

$$\partial_{\alpha}F^{\alpha\beta} = \frac{4\pi}{c}J^{\beta} \quad \text{and} \quad \partial_{\alpha}D^{\alpha\beta} = 0^{\beta}. \quad (38)$$

The two-index $F^{\alpha\beta}$ and $D^{\alpha\beta}$ tensors refer to the electromagnetic field and the 'dual' thereof. The electromagnetic field tensor $F^{\alpha\beta}$ has merates that are components of the three-dimensional electric and magnetic field vectors, \mathbf{E} and \mathbf{B} . The $D^{\alpha\beta}$ is the dual to $F^{\alpha\beta}$, whose merates are components of \mathbf{B} and $-\mathbf{E}$. The one-index tensors J^{β} and ∂_{α} refer to the source charge-current density vector and the differential operator vector. The indices α and β take the four values 0,1,2,3.

The seeming limitation of Maxwell's equations to invariance only under Lorentz transformation arises entirely from the differential operator being written as a covariant vector. In the extended tensor algebra, this operator is identified as transcovariant, and then Maxwell's equations look like:

$$({}_\alpha \partial) F^{\alpha\beta} = \frac{4\pi}{c} J^\beta \quad \text{and} \quad ({}_\alpha \partial) D^{\alpha\beta} = 0^\beta. \quad (39)$$

Written this way, Maxwell's equations are manifestly form invariant, not only under Lorentz transformation, but also under any arbitrary (just well-behaved) transformation, including Galilean transformation.

7. Conclusions

About Maxwell's equations and photons: Photons have a life history that begins with emission as an electromagnetic pulse, proceeds with development into a waveform, then changes into regression back to a pulse, and ends with absorption by a receiver. This life history of the photon can be modeled by imagining some mirrors that apply boundary conditions corresponding to the desired scenario, feeding a Gaussian pulse at the source to Maxwell's equations, watching Hermite polynomials then emerge, and then finally pile up at the receiver.

About EM signals and photons: The life history of the photon suggests that the assumption upon which Einstein's SRT is founded is over-simplified. If we will make the founding assumption more realistic, then we will get more believable results. The more believable results can help us reconcile SRT with the QM of atoms. We can understand why Planck's constant occurs. It represents the balance between competing phenomena: on the one hand, energy loss due to radiation from accelerating charges; on the other hand, energy gain due to internal torquing within the atomic system due to finite speed of signal propagation.

About Atoms: Viewed in the right way, chemical and spectroscopic data reveal a tremendous amount of regularity. So we are well enabled to interpolate and extrapolate for situations where actual data is not available. We can analyze scenarios where electrons are subtracted from or added to an atom, all at once, or one at a time; whatever we need. But take care: in the existing literature, the distinction between 'all-at-once' and 'one-at-a-time' is often obscure, so be careful.

About Maxwell and Newton: There should have been no conflict between Maxwell's equations and Newton's equations over the issue of transformation invariance. Maxwell's equations are form invariant under Galilean transformations, just as they are form invariant under Lorentz transformations. Physics does not have conflicts. Only people have conflicts. And people can resolve their conflicts. The conflict perceived in the case of Newton *vs.* Maxwell is resolved with an extension of mathematical formalism.

About Physics in General: This work has shown that SRT deserves a moment of caution, and the reader may reasonably worry that GRT deserves some caution too. So it may be premature to develop a theory of quantum gravity. Placing the QG capstone onto the RT and QM pillars of 20th century physics may produce something that resembles the ancient constructions at Stonehenge, but not the Gothic cathedrals of Europe, much less anything modern.

8. Appendix 1. Numerical data on ionization potentials for all elements

Element	Charge Z	Mass M	Ionization Potential	$IP =$ Ionization Potential $\times M / Z$	Model IP	Model ΔIP
H	1	1.008	13.610	13.718	14.250	0
He	2	4.003	24.606	49.244	49.875	35.625
Li	3	6.941	5.394	12.480	12.469	-1.781
Be	4	9.012	9.326	21.011	23.327	9.077
B	5	10.811	8.309	17.966	17.055	2.805
C	6	12.011	11.266	22.551	21.570	7.320
N	7	14.007	14.544	29.101	27.281	13.031
O	8	15.999	13.631	27.260	27.281	13.031
F	9	18.998	17.438	36.810	34.504	20.254
Ne	10	20.180	21.587	43.562	43.641	29.391
Na	11	22.990	5.145	10.753	10.910	-3.340
Mg	12	24.305	7.656	15.506	16.565	2.315
Al	13	26.982	5.996	12.444	14.923	0.673
Si	14	28.086	8.154	16.357	18.874	4.624
P	15	30.974	10.498	21.677	23.871	9.621
S	16	32.066	10.373	20.790	23.871	9.621
Cl	17	35.453	12.977	27.063	30.192	15.942
Ar	18	39.948	15.778	35.017	38.186	23.936

Periods 1, 2 and 3.

Element	Charge Z	Mass M	Ionization Potential	$IP = \text{Ionization}$ Potential $\times M / Z$	Model IP	Model ΔIP
K	19	39.098	4.346	8.944	9.546	-4.704
Ca	20	40.078	6.120	12.265	13.057	-1.193
Sc	21	44.956	6.546	14.013	13.057	-1.193
Ti	22	47.867	6.826	14.851	13.638	-0.612
V	23	50.942	6.743	14.934	14.244	-0.006
Cr	24	51.996	6.774	14.676	14.877	0.627
Mn	25	54.938	7.438	16.345	15.539	1.289
Fe	26	55.845	7.873	16.911	15.539	1.289
Co	27	58.933	7.863	17.163	16.229	1.980
Ni	28	58.693	7.645	16.026	16.951	2.701
Cu	29	63.546	7.728	16.934	17.705	3.455
Zn	30	65.390	9.398	20.485	18.492	4.242
Ga	31	69.723	6.006	13.509	14.494	0.244
Ge	32	72.610	7.905	17.936	17.860	3.610
As	33	74.922	9.824	22.303	22.007	7.757
Se	34	78.960	9.761	22.669	22.007	7.757
Br	35	79.904	11.826	26.998	27.116	12.866
Kr	36	83.800	14.015	32.623	33.412	19.162

Period 4.

Element	Charge <i>Z</i>	Mass <i>M</i>	Ionization Potential	<i>IP</i> = Ionization Potential $\times M / Z$	Model <i>IP</i>	Model ΔIP
Rb	37	85.468	4.180	9.657	9.546	-4.704
Sr	38	87.620	5.695	13.132	13.057	-1.193
Y	39	88.906	6.390	14.567	13.057	-1.193
Zr	40	91.224	6.846	15.614	13.638	-0.612
Nb	41	92.906	6.888	15.608	14.244	-0.006
Mo	42	95.940	7.106	16.232	14.877	0.627
Tc	43	98.000	7.282	16.597	15.539	1.289
Ru	44	101.070	7.376	16.942	15.539	1.289
Rh	45	102.906	7.469	17.080	16.230	1.980
Pd	46	106.420	8.351	19.319	16.951	2.701
Ag	47	107.868	7.583	17.403	17.705	3.455
Cd	48	112.411	9.004	21.087	18.492	4.242
In	49	114.818	5.788	13.563	14.494	0.244
Sn	50	118.710	7.355	17.462	17.860	3.610
Sb	51	121.760	8.651	20.655	22.007	7.757
Te	52	127.600	9.015	22.120	22.007	7.757
I	53	126.904	10.456	25.037	27.116	12.866
Xe	54	131.290	12.137	29.508	33.412	19.162

Period 5.

Element	Charge Z	Mass M	Ionization Potential	$IP = \text{Ionization}$ Potential $\times M / Z$	Model IP	Model ΔIP
Cs	55	132.905	3.900	9.425	9.546	-4.704
Ba	56	137.327	5.218	12.796	13.057	-1.192
La	57	138.906	5.581	13.600	12.393	-1.857
Ce	58	140.116	5.477	13.232	12.583	-1.667
Pr	59	140.908	5.425	12.957	12.776	-1.474
Nd	60	144.240	5.498	13.217	12.972	-1.278
Pm	61	145.000	5.550	13.192	13.171	-1.079
Sm	62	150.360	5.633	13.660	13.374	-0.876
Eu	63	151.964	5.674	13.687	13.579	-0.671
Gd	64	157.250	6.141	15.089	13.579	-0.671
Tb	65	158.925	5.851	14.305	13.787	-0.463
Dy	66	162.500	5.934	14.609	13.999	-0.251
Ho	67	164.930	6.027	14.836	14.213	-0.037
Er	68	167.260	6.110	15.029	14.431	0.181
Tm	69	168.934	6.183	15.137	14.653	0.403
Yb	70	170.040	6.255	15.463	14.878	0.627
Lu	71	174.967	5.436	13.395	17.860	3.610
Hf	72	178.490	7.054	17.487	18.755	4.505
Ta	73	180.948	7.894	19.568	19.696	5.446
W	74	183.840	7.988	19.844	20.684	6.434
Re	75	186.207	7.884	19.574	21.721	7.471
Os	76	190.230	8.714	21.811	21.721	7.471
Ir	77	192.217	9.129	22.788	22.811	8.560
Pt	78	195.076	9.025	22.571	23.955	9.705
Au	79	196.967	9.232	23.019	25.156	10.906
Hg	80	200.530	10.446	26.184	26.418	12.168
Tl	81	204.383	6.110	15.417	16.515	2.265
Pb	82	207.200	7.427	18.768	19.696	5.446
Bi	83	208.980	7.293	18.361	23.490	9.240
Po	84	209.000	8.423	20.958	23.490	9.240
At	85	210.000			28.015	13.765
Rn	86	222.000	10.757	27.769	33.412	19.164

Period 6.

Element	Charge Z	Mass M	Ionization Potential	$IP = \text{Ionization}$ Potential $\times M / Z$	Model IP	Model ΔIP
Fr	87	223.000			9.546	-4.704
Ra	88	226.000	5.280	13.560	13.057	-1.193
Ac	89	227.000	6.950	17.727	12.393	-1.857
Th	90	232.038	6.089	15.699	12.583	-1.667
Pa	91	231.036	5.892	14.959	12.776	-1.474
U	92	238.029	6.203	16.050	12.972	-1.277
Np	93	237.000	6.276	15.994	13.171	-1.079
Pu	94	244.000	6.068	15.752	13.374	-0.876
Am	95	243.000	5.996	15.337	13.579	-0.671
Cm	96	247.000	6.027	15.507	13.579	-0.671
Bk	97	247.000	6.234	15.875	13.787	-0.463
Cf	98	251.000	6.307	16.154	13.999	-0.251
Es	99	252.000	6.421	16.345	14.213	-0.037
Fm	100	257.000	6.504	16.716	14.431	0.181
Md	101	258.000	6.587	16.827	14.653	0.403
No	102	259.000	6.660	16.911	14.877	0.627
Lf	103				17.859	3.610
Rf	104				18.755	4.505
Db	105				19.696	5.446
Sg	106				20.684	6.434
Bh	107				21.721	7.471
Hs	108				21.721	7.471
Mt	109				22.811	8.561
Uun	110				23.955	9.705
Uuu	111				25.156	10.906
Uub	112				26.418	12.168
???	113				16.515	2.265
???	114				17.019	2.769
???	115				23.490	9.240
???	116				23.490	9.240
???	117				28.015	13.765
???	118				33.412	19.162

Period 7.

9. Acknowledgments

The author thanks colleagues for deep and intense conversations on the topics discussed here, especially Dr. Peter Enders, Dr. Yuri Keilman, Dr. Robert Kiehn, Prof. Zbigniew Oziewicz, and Dr. Tom Phipps.

10. References

- Aspden, H. (1990) 'Electron Clusters' (Correspondence) *Galilean Electrodynamics vol. 1*, 81-82.
- Beckmann, P. (1990), "Electron Clusters", *Galilean Electrodynamics vol. 1*, 55-58 (1990); see also *vol. 1*, 82.
- Kiein, R. M. (2009), *Non-Equilibrium Systems and Irreversible Processes*, Vol. 4, Adventures in Applied Topology, especially Sect. 2.2.3, <http://www22.pair.com/csdc/kok/ebookvol4.pdf>.
- Piestrup, M.A., Puthoff, H.E., & Ebert, P.J. (1998). Correlated Emissions of Electrons, *Galilean Electrodynamics vol. 9*, 43-49.
- Putz, M. V., Ed., (2009) *Quantum Frontiers of Atoms and Molecules*, Nova Science Publishers, New York.
- Rowlands, P. (2007), *Zero to Infinity – The Foundations of Physics*, Chapter 16, The Factor 2 and Duality, World Scientific, New Jersey, London, etc.
- Thomas, L.H. (1927), The Kinematics of an electron with an Axis, *Phil. Mag.* S. 7, 3 (13) 1-22.
- Wheeler, J.A., and Feynman, R.P. (1945). Interaction with the Absorber as the Mechanism of Radiation, *Revs. Mod. Phys.*, 17 (2 & 3) 157-181.
- Wheeler, J.A., and Feynman, R.P. (1949). Classical Electrodynamics in Terms of Direct Interparticle Action, *Revs. Mod. Phys.*, 21 (3) 425-433.
- Whitney, C.K. (2012). *Algebraic Chemistry: Applications and Origins*, Nova Science Publishers.

Nonrelativistic Quantum Mechanics with Fundamental Environment

Ashot S. Gevorkyan

Institute for Informatics and Automation Problems,

National Academy of Sciences

BioArt Company (LTD)

Republic of Armenia

1. Introduction

Now it is obvious that quantum mechanics enters in the 21st century into a principally new and important phase of its development which will cardinally change the currently used technical facilities in the areas of information and telecommunication technologies, exact measurements, medicine etc. Indisputably, all this on the whole will change the production potential of human civilization and influence its morality. Despite unquestionable success of quantum physics in the 20th century, including creation of lasers, nuclear energy use, etc. it seems that possibilities of the quantum nature are not yet studied and understood deeply, a fortiori, are used.

The central question which arises on the way of gaining a deeper insight into the quantum nature of various phenomena is the establishment of well-known accepted criteria of applicability of quantum mechanics. In particular, the major of them is the de-Broglie criterion, which characterizes any body-system by a wave the length of which is defined as $\lambda = \hbar/p$, where λ is the wavelength of the body-system, p is its momentum and \hbar is the Plank constant. An important consequence of this formula is that it assigns the quantum properties only to such systems which have extremely small masses. Moreover, it is well known that molecular systems which consist of a few heavy atoms are, as a rule, well described by classical mechanics. In other words, the de-Broglie criterion is an extremely strong limitation for occurrence of quantum effects in macroscopic systems. Till now only a few macroscopic quantum phenomena have been known, such as superfluidity and superconductivity, which are not ordinary natural phenomena but most likely extremal states of nature. Thus, a reasonable question arises, namely, how much correct is the de-Broglie criterion, or more precisely, how completely this criterion reflects the quantum properties of a system.

In order to answer this essentially important question for development of quantum physics, it is necessary to expand substantially the concepts upon which quantum mechanics is based. The necessity for generalization of quantum mechanics is also dictated by our aspiration to consider such hard-to-explain phenomena as spontaneous transitions between the quantum levels of a system, the Lamb Shift of energy levels, EPR paradox, etc. within the limits of a united scheme. In this connection it seems important to realize finally the concept according to which any quantum system is basically an open

system, especially when we take into account the vacuum's quantum fluctuations [1- 3]. Specifically for a quantum noise coming from vacuum fluctuations we understand a stationary Wiener-type source with noise intensity proportional to the *vacuum power* $P \equiv \hbar \langle \omega^2 \rangle / 4$, where $\langle \omega^2 \rangle$ is the variance of the field frequencies averaged over some appropriate distribution (we assume $\langle \omega \rangle = 0$ since ω and $-\omega$ must be considered as independent fluctuations). For example, in the cosmic background case where $T = 2K$ we find, correspondingly, $P = 1.15 pW$. Calculation of $\langle \omega^2 \rangle$ for quantum fluctuations is not trivial because vacuum energy density diverges as ω^3 [3] with uniform probability distribution denying a simple averaging process unless physical cutoffs at high frequencies exist.

Thus, first of all we need such a generalization of quantum mechanics which includes nonperturbative vacuum as *fundamental environment* (FE) of a quantum system (QS). As our recent theoretical works have shown [4-9], this can be achieved by naturally including the traditional scheme of nonrelativistic quantum mechanics if we define quantum mechanics in the limits of a nonstationary complex stochastic differential equation for a wave function (conditionally named a stochastic Schrödinger equation). Indeed, within the limits of the developed approach it is possible to solve the above-mentioned traditional difficulties of nonrelativistic quantum mechanics and obtain a new complementary criterion which differs from de-Broglie's criterion. But the main achievement of the developed approach is that in the case when the de-Broglie wavelength vanishes and the system, accordingly, becomes classical within the old conception, nevertheless, it can have quantum properties by a new criterion.

Finally, these quantum properties or, more exactly, quantum-field properties can be strong enough and, correspondingly, important for their studying from the point of view of quantum foundations and also for practical applications.

The chapter is composed of two parts. The first part includes a general scheme of constructing the nonrelativistic quantum mechanics of a bound system with FE. In the second part of the chapter we consider the problem of a quantum harmonic oscillator with fundamental environment. Since this model is being solved exactly, its investigation gives us a lot of new and extremely important information on the properties of real quantum systems, which in turn gives a deeper insight into the nature of quantum foundations.

2. Formulation of the problem

We will consider the nonrelativistic quantum system with random environment as a closed united system QS and FE within the limits of a *stochastic differential equation* (SDE) of Langevin-Schrödinger (L-Sch) type:

$$i\partial_t \Psi_{stc} = \hat{H}(\mathbf{x}, t; \{\mathbf{f}\}) \Psi_{stc}, \quad \partial_t \equiv \partial / \partial t, \quad -\infty < t < +\infty. \quad (2.1)$$

In equation (2.1) the stochastic operator $\hat{H}(\mathbf{x}, t; \{\mathbf{f}\})$ describes the evolution of the united system QS + FE, where $\{\mathbf{f}\}$ is a random vector forces generating the environment fluctuations. In addition, in the units $\hbar = m = 1$ the operator has the form:

$$\hat{H}(\mathbf{x}, t; \{\mathbf{f}\}) = -\frac{1}{2} \Delta + V(\mathbf{x}, t; \{\mathbf{f}\}), \quad \mathbf{x} \in \mathbf{R}^3, \quad (2.2)$$

where Δ denotes a Laplace operator, $V(\mathbf{x}, t; \{\mathbf{f}\})$ describes the interaction potential in a quantum system which has regular and stochastic terms.

We will suppose that when $\{\mathbf{f}\} \equiv 0$, the system executes regular motion which is described by the regular nonstationary interaction potential $V_0(\mathbf{x}, t) = V(\mathbf{x}, t; \{\mathbf{f}\})|_{\{\mathbf{f}\}=0}$. In this case the quantum system will be described by the equation:

$$i\partial_t \Psi = \hat{H}_0(\mathbf{x}, t) \Psi, \quad \hat{H}_0(\mathbf{x}, t) \equiv \hat{H}(\mathbf{x}, t; \{\mathbf{f}\})|_{\{\mathbf{f}\}=0}. \quad (2.3)$$

We also assume that in the limit $t \rightarrow -\infty$ the QS passes to an autonomous state which mathematically equals to the problem of eigenvalues and eigenfunctions:

$$\Delta \Phi_- + 2(E_- - V_-(\mathbf{x}))\Phi_- = 0, \quad \Psi(\mathbf{x}, t)|_{t \rightarrow -\infty} \sim e^{-iE_- t} \Phi_-, \quad (2.4)$$

where in the (*in*) asymptotic state E_- designates the energy of the quantum system and, correspondingly, the interaction potential is defined by the limit: $V_-(\mathbf{x}) = \lim_{t \rightarrow -\infty} V_0(\mathbf{x}, t)$. In the (*out*) asymptotic state when the interaction potential tends to the limit: $V_+ = \lim_{t \rightarrow +\infty} V_0(\mathbf{x}, t)$, the QS is described by the orthonormal basis $\{\Phi_+(\mathbf{g}|\mathbf{x})\}$ and eigenvalues $\{E_+(\mathbf{g})\}$, where $\mathbf{g} \equiv (n, m, \dots)$ designates an array of quantum numbers.

Further we assume that the solution of problem (2.4) leads to the discrete spectrum of energy and wave functions which change adiabatically during the evolution (problem (2.3)). The latter implies that the wave functions form a full orthogonal basis:

$$\int_{\mathbb{R}^3} \Psi(\mathbf{g}|\mathbf{x}, t) \Psi^*(\mathbf{g}'|\mathbf{x}, t) d^3\mathbf{x} = \delta_{\mathbf{g} \mathbf{g}'}, \quad (2.5)$$

where the symbol $*$ means complex conjugation.

Finally, it is important to note that an orthogonality condition similar to (2.5) can be written also for a stochastic wave function: $\int_{\mathbb{R}^3} \Psi_{stc}(\mathbf{g}|\mathbf{x}, t; \{\xi\}) \Psi^*(\mathbf{g}'|\mathbf{x}, t; \{\xi\}) d^3\mathbf{x} = 1$, where $\{\xi\}$ designates random field (definition see below).

2.1 The equation of environment evolution

The solution of (2.1) can be represented,

$$\Psi_{stc}(\mathbf{x}, t; \{\xi\}) = \sum_{\mathbf{g}} U_{\mathbf{g}}(t) \Psi(\mathbf{g}|\mathbf{x}, t). \quad (2.6)$$

Now substituting (2.6) into (2.1) with taking into account (2.3) and (2.5), we can find the following system of complex SDEs:

$$i\delta_{\mathbf{g}'\mathbf{g}} \dot{U}_{\mathbf{g}'}(t) = \{iA_{\mathbf{g}'\mathbf{g}}(t) + F_{\mathbf{g}'\mathbf{g}}(t; \{\mathbf{f}\})\} U_{\mathbf{g}'}, \quad \dot{U}_{\mathbf{g}}(t) = dU_{\mathbf{g}}(t)/dt, \quad (2.7)$$

where the following designations are made:

$$A_{\mathbf{g}'\mathbf{g}}(t) = \int_{\mathbb{R}^3} \Psi^*(\mathbf{g}|\mathbf{x}, t) \partial_t \Psi(\mathbf{g}'|\mathbf{x}, t) d^3\mathbf{x},$$

$$F_{\mathbf{g}'\mathbf{g}}(t; \{\mathbf{f}\}) = \int_{\mathbb{R}^3} \Psi^*(\mathbf{g}|\mathbf{x}, t) [V(\mathbf{x}, t; \{\mathbf{f}\}) - V_0(\mathbf{x}, t)] \Psi(\mathbf{g}'|\mathbf{x}, t) d^3\mathbf{x}.$$

Recall that in (2.7) dummy indices denote summations; in addition, it is obvious that the coefficients $A_{g'g}(t)$ and $F_{g'g}(t; \{\mathbf{f}\})$ are, in general, complex functions.

For further investigations it is useful to represent the function $U_g(t)$ in the form of a sum of real and imaginary parts:

$$U_g(t) = u_g(t) + i v_g(t). \quad (2.8)$$

Now, substituting expression (2.8) into (2.7), we can find the following system of SDEs:

$$\begin{cases} \delta_{g'g} \dot{u}_{g'} = [A_{g'g}^{(1)}(t) + F_{g'g}^{(2)}(t; \{\mathbf{f}\})] u_{g'} - [A_{g'g}^{(2)}(t) - F_{g'g}^{(1)}(t; \{\mathbf{f}\})] v_{g'}, \\ \delta_{g'g} \dot{v}_{g'} = [A_{g'g}^{(2)}(t) - F_{g'g}^{(1)}(t; \{\mathbf{f}\})] u_{g'} + [A_{g'g}^{(1)}(t) + F_{g'g}^{(2)}(t; \{\mathbf{f}\})] v_{g'}, \end{cases} \quad (2.9)$$

where the following designations are made:

$$\begin{aligned} A_{g'g}^{(1)}(t) &= \operatorname{Re} A_{g'g}(t), & F_{g'g}^{(1)}(t; \{\mathbf{f}\}) &= \operatorname{Re} F_{g'g}(t; \{\mathbf{f}\}), \\ A_{g'g}^{(2)}(t) &= \operatorname{Im} A_{g'g}(t), & F_{g'g}^{(2)}(t; \{\mathbf{f}\}) &= \operatorname{Im} F_{g'g}(t; \{\mathbf{f}\}). \end{aligned}$$

Ordering a set of random processes $\{u_g(t), v_g(t)\}$, the coefficients $\{A_{g'g}^{(1)}(t), A_{g'g}^{(2)}(t)\}$ and random forces $\{F_{g'g}^{(1)}(t; \{\mathbf{f}\}), F_{g'g}^{(2)}(t; \{\mathbf{f}\})\}$, one can rewrite the system of SDEs as:

$$\dot{\xi}_i = a_i(\boldsymbol{\xi}, t) + \sum_{j=1}^n b_{ij}(\boldsymbol{\xi}, t) f_j(t), \quad \dot{\xi}_i(t) = d\xi_i/dt. \quad (2.10)$$

In the system of equations (2.10) the symbol $\boldsymbol{\xi}$ describes a random vector process represented in the following form: $\boldsymbol{\xi} \equiv \boldsymbol{\xi}(\dots u_{g_i} \dots, \dots v_{g_j} \dots)$, $(1, \dots, i, \dots, j, \dots, n)$, where n is the total number of random components which is twice as big as the total number of quantum states. In addition, the members $a_i(\boldsymbol{\xi}, t)$ in equations (2.10) are composed of the matrix elements $\{A_{g'g}^{(1)}(t), A_{g'g}^{(2)}(t)\}$ and regular parts of matrix elements $\{F_{g'g}^{(1)}(t; \{\mathbf{f}\}), F_{g'g}^{(2)}(t; \{\mathbf{f}\})\}$ while the random forces $f_j(t)$ are composed of random parts of the above matrix elements.

Assuming that random forces satisfy the conditions of white noise:

$$\langle f_j(t) \rangle = 0, \quad \langle f_i(t) f_j(t') \rangle = \lambda_{ij} \delta(t - t'), \quad (2.11)$$

where $\lambda_{ij} = 0$, if $i \neq j$ and $\lambda_{ii} \equiv \lambda_i > 0$.

Now, using the system of equations (2.10) and correlation properties (2.11), it is easy to obtain the Fokker-Planck equation for the joint probability distribution of fields $\{\boldsymbol{\xi}\}$ (see in particular [6, 10]):

$$\partial_t P = \hat{L}^{(n)} P, \quad (2.12)$$

where the operator $\hat{L}^{(n)}$ is defined by the form:

$$\hat{L}^{(n)} = - \sum_{i=1}^n \frac{\partial}{\partial \xi_i} a_i(\boldsymbol{\xi}, t) + \sum_{i,j,k,l=1}^n \frac{\partial}{\partial \xi_i} \left(b_{ik}(\boldsymbol{\xi}, t) \frac{\partial}{\partial \xi_j} b_{jl}(\boldsymbol{\xi}, t) \right), \quad (2.12')$$

The joint probability in (2.12) is defined by the expression:

$$P(\boldsymbol{\xi}, t | \boldsymbol{\xi}_0, t_0) = \left\langle \prod_{i=1}^n \delta(\xi_i(t) - \xi_{0i}) \right\rangle, \quad \xi_{0i} \equiv \xi_i(t_0), \quad (2.13)$$

From this definition, in particular, it follows that equation (2.12) must satisfies to the initial condition:

$$P(\boldsymbol{\xi}, t | \boldsymbol{\xi}_0, t_0) |_{t=t_0} = \prod_{i=1}^n \delta(\xi_i - \xi_{0i}), \quad (2.13')$$

where t_0 is the moment of switching of environment influence; in addition, the coordinates ξ_i compose the n -dimensional non-Euclidian space $\xi_i \in \Xi^n$.

Finally, since the function $P(\boldsymbol{\xi}, t | \boldsymbol{\xi}_0, t_0)$ has the meaning of probability distribution, we can normalize it:

$$\int_{\Xi^n} \tilde{P}(\boldsymbol{\xi}, t | \boldsymbol{\xi}_0, t_0) d^n \boldsymbol{\xi} = 1, \quad \tilde{P}(\boldsymbol{\xi}, t | \boldsymbol{\xi}_0, t_0) = N^{-1}(t) P(\boldsymbol{\xi}, t | \boldsymbol{\xi}_0, t_0), \quad (2.14)$$

where the function $N(t)$ is the term which implements performing of the normalization condition to unit, defined by the expression: $N(t) = \int_{\Xi^n} P(\boldsymbol{\xi}, t | \boldsymbol{\xi}_0, t_0) d^n \boldsymbol{\xi}$.

2.2 Stochastic density matrix method

We consider the following bilinear form (see representation (2.6)):

$$\rho_{stc}(\mathbf{x}, t; \{\boldsymbol{\xi}\} | \mathbf{x}', t'; \{\boldsymbol{\xi}'\}) = \sum_{\mathbf{g}, \mathbf{g}'} U_{\mathbf{g}}(t) U_{\mathbf{g}'}^*(t') \Psi(\mathbf{g} | \mathbf{x}, t) \Psi^*(\mathbf{g}' | \mathbf{x}', t'), \quad (2.15)$$

where the symbol "*" means complex conjugation.

After integrating (2.15) by the coordinates $\mathbf{x} \in \mathbf{R}^3$ and $\boldsymbol{\xi} \in \Xi^n$ with taking into account the weight function (2.13), we can find:

$$I(t) = Tr_{\boldsymbol{\xi}} Tr_{\mathbf{x}} [\rho_{stc}(\mathbf{x}, t; \{\boldsymbol{\xi}\} | \mathbf{x}', t'; \{\boldsymbol{\xi}'\})] = \sum_{\mathbf{g}} \langle |U_{\mathbf{g}}(t)|^2 \rangle, \quad (2.16)$$

where $\langle |U_{\mathbf{g}}(t)|^2 \rangle = Tr_{\boldsymbol{\xi}} \{ |U_{\mathbf{g}}(t)|^2 \} = \int_{\Xi^n} \tilde{P}(\boldsymbol{\xi}, t | \boldsymbol{\xi}_0, t_0) |U_{\mathbf{g}}(t)|^2 d^n \boldsymbol{\xi}$.

Now, using (2.16) we can construct an expression for a usual nonstationary density matrix [12]:

$$\rho(\mathbf{x}, t | \mathbf{x}', t') = \sum_{\mathbf{g}} \Lambda_{\mathbf{g}}(t) \Psi(\mathbf{g} | \mathbf{x}, t) \Psi^*(\mathbf{g}' | \mathbf{x}', t'). \quad (2.17)$$

where $\Lambda_g(t) = \langle |U_g(t)|^2 \rangle / I(t)$ has the meaning of level population of the quantum state under the conditions of equilibrium between the quantum system and fundamental environment. It is easy to check that the stochastic density matrix $\rho_{stc}(\mathbf{x}, t; \{\xi\} | \mathbf{x}', t'; \{\xi'\})$ satisfy to von Neumann equation while the reduced density matrix $\rho(\mathbf{x}, t | \mathbf{x}', t')$ does not satisfies the equation. Taking into account equations (2.1), (2.13) and (2.15), we can obtain the evolution equation for reduced density matrix:

$$i \langle \partial_t \rho_{stc}(\mathbf{x}, t; \{\xi\} | \mathbf{x}', t'; \{\xi'\}) \rangle = \left\langle \left[\hat{H}, \rho_{stc}(\mathbf{x}, t; \{\xi\} | \mathbf{x}', t'; \{\xi'\}) \right] \right\rangle. \quad (2.18)$$

where $Tr_{\xi} \{ \dots \} = \langle \dots \rangle$, in addition $[\dots]$ describes the quantum Poisson brackets which denote the commutator: $[A, B] = AB - BA$.

It is obvious that equation (2.18) is a nonlocal equation. Taking into account (2.12), one can bring equation (2.18) to the form:

$$i \partial_t \rho(\mathbf{x}, \mathbf{x}', t) = \left[\hat{H}_0, \rho(\mathbf{x}, \mathbf{x}', t) \right] + i \int_{\Xi^n} \rho_{stc}(\mathbf{x}, \mathbf{x}', t; \{\xi\}) \bar{L}^{(n)} \tilde{P}(\xi, t | \xi_0, t_0) d^n \xi, \quad (2.19)$$

where following designations are made; $\rho(\mathbf{x}, \mathbf{x}', t) = \rho(\mathbf{x}, t | \mathbf{x}', t')|_{t=t'}$ is a reduced density matrix, in addition, $\rho_{stc}(\mathbf{x}, \mathbf{x}', t; \{\xi\}) = \rho_{stc}(\mathbf{x}, t; \{\xi\} | \mathbf{x}', t'; \{\xi'\})|_{t=t'}$.

Thus, equation (2.19) differs from the usual von Neumann equation for the density matrix. The new equation (2.19), unlike the von Neumann equation, considers also the exchange between the quantum system and fundamental environment, which in this case plays the role of a thermostat.

2.3 Entropy of the quantum subsystem

For a quantum ensemble, entropy was defined for the first time by von Neumann [11]. In the considered case where instead of a quantum ensemble one united system QS + FE, the entropy of the quantum subsystem is defined in a similar way:

$$S(\lambda; t) = -Tr_x \left[\rho(\mathbf{x}, \mathbf{x}', t) \ln \rho(\mathbf{x}, \mathbf{x}', t) \right], \quad \lambda = \{ \lambda_i \}. \quad (2.20)$$

In connection with this, there arises an important question about the behavior of the entropy of a multilevel quantum subsystem on a large scale of times. It is obvious that the relaxation process can be nontrivial (for example, absence of the stationary regime in the limit $t \rightarrow +\infty$) and, hence, its investigation will be a difficult-to-solve problem both by analytic methods and numerical simulation.

A very interesting case is when the QS breaks up into several subsystems. In particular, when the QS breaks up into two fragments and when these fragments are spaced far from each other, we can write for a reduced density matrix of the subsystem the following expression:

$$\rho(\mathbf{x}, \mathbf{x}', t) = \rho_1(\mathbf{y}, \mathbf{y}', t) \rho_2(\mathbf{z}, \mathbf{z}', t), \quad \mathbf{x} \equiv \mathbf{x}(\mathbf{y}; \mathbf{z}), \quad (\mathbf{y}; \mathbf{z}) \in R^3. \quad (2.21)$$

Recall that the vectors \mathbf{y} and \mathbf{z} describe the first and second fragments, correspondingly. Now, substituting the reduced density matrix $\rho(\mathbf{x}, \mathbf{x}', t)$ into the expression of the entropy of QS (2.20), we obtain:

$$S(\lambda; t) = -J_1(\lambda; t) S_2(\lambda; t) - J_2(\lambda; t) S_1(\lambda; t), \quad (2.22)$$

where the following designations are made in expression (2.22):

$$J_1(\lambda;t) = \text{Tr}_y[\rho_1(\mathbf{y}, \mathbf{y}', t)], \quad S_1(\lambda;t) = -\text{Tr}_y[\rho(\mathbf{y}, \mathbf{y}', t) \ln \rho(\mathbf{y}, \mathbf{y}', t)],$$

$$J_2(\lambda;t) = \text{Tr}_z[\rho_2(\mathbf{z}, \mathbf{z}', t)], \quad S_2(\lambda;t) = -\text{Tr}_z[\rho(\mathbf{z}, \mathbf{z}', t) \ln \rho(\mathbf{z}, \mathbf{z}', t)].$$

Since at the beginning of evolution the two subsystems interact with each other, it is easy to show that $J_1(\lambda;t) \neq 1$ and $J_2(\lambda;t) \neq 1$, moreover, they can be fluctuated depending on the time. The last circumstance proves that the subsystems of the QS are in the entangled state. This means that between the two subsystems there arises a new type of nonpotential interaction which does not depend on the distance and size of the subsystems. In the case when subsystems 1 and 2 have not interacted, $J_1 = J_2 = 1$ and, correspondingly, S_1 and S_2 are constants denoting entropies of isolated systems.

2.4 Conclusion

The developed approach allows one to construct a more realistic nonrelativistic quantum theory which includes fundamental environment as an integral part of the quantum system. As a result, the problems of spontaneous transitions (including decay of the ground state) between the energy levels of the QS, the Lamb shift of the energy levels, ERP paradox and many other difficulties of the standard quantum theory are solved naturally. Equation (2.12) - (2.13') describes quantum peculiarities of FE which arises under the influence of the quantum system. Unlike the de-Broglie wavelength, they do not disappear with an increase in mass of the quantum subsystem. In other words, the macroscopic system is obviously described by the classical laws of motion; however, space-times structures can be formed in FE under its influence. Also, it is obvious that these quantum-field structures ought to be interpreted as a natural continuation and addition to the considered quantum (classical) subsystem. These quantum-field structures under definite conditions can be quite observable and measurable. Moreover, it is proved that after disintegration of the macrosystem into parts its fragments are found in the entangled state, which is specified by nonpotential interaction (2.22), and all this takes place due to fundamental environment. Especially, it concerns nonstationary systems, for example, biological systems in which elementary atom-molecular processes proceed continuously [13]. Note that such a conclusion becomes even more obvious if one takes into account the well-known work [14] where the idea of universal description for unified dynamics of micro- and macroscopic systems in the form of the Fokker-Planck equation was for the first time suggested.

Finally, it is important to add that in the limits of the developed approach the closed system QS + FE in equilibrium is described in the extended space $R^3 \otimes \Xi^n$, where Ξ^n can be interpreted as a compactified subspace in which FE in equilibrium state is described.

3. The quantum one-dimensional harmonic oscillator (QHO) with FE as a problem of evolution of an autonomous system on the stochastic space-time continuum

As has been pointed out in the first part of the chapter, there are many problems of great importance in the field of non-relativistic quantum mechanics, such as the description of the Lamb shift, spontaneous transitions in atoms, quantum Zeno effect [15] etc., which remain

unsolved due to the fact that the concept of physical vacuum has not been considered within the framework of standard quantum mechanics. There are various approaches for investigation of the above-mentioned problems: the quantum state diffusion method [16], Lindblad density matrix method [17, 18], quantum Langevin equation [19], stochastic Schrödinger equation method (see [12]), etc. Recall that representation [17, 18] describes a priori the most general situation which may appear in a non-relativistic system. One of these approaches is based on the consideration of the wave function as a random process, for which a stochastic differential equation (SDE) is derived. However, the consideration of a reduced density matrix on a semi-group [20] is quite an ambiguous procedure and, moreover, its technical realization is possible, as a rule, only by using the perturbation method. For investigation of the inseparably linked closed system QSE, a new mathematical scheme has been proposed [5-8] which allows one to construct all important parameters of the quantum system and environment in a closed form. The main idea of the developed approach is the following. We suppose that the evolution time of the combined system consists of an infinite set of time intervals with different duration, where at the end of each interval a random force generated by the environment influences the quantum subsystem. At the same time the motion of the quantum subsystem within each time interval can be described by the Schrödinger equation. Correspondingly, the equation which describes the combined closed system QSE on a large scale of time can be represented by the *stochastic differential equation* of Langevin-Schrödinger (L-Sch) type.

In this section, within the framework of the 1D L-Sch equation an exact approach for the quantum harmonic oscillator (QHO) model with fundamental environment is constructed. In particular, the method of stochastic density matrix (SDM) is developed, which permits to construct all thermodynamic potentials of the quantum subsystem analytically, in the form of multiple integrals from the solution of a 2D second-order partial differential equation.

3.1 Description of the problem

We will consider that the 1D QHO+FE closed system is described within the framework of the L-Sch type SDE (see equation (2.1)), where the evolution operator has the following form:

$$\hat{H}(x, t; \{f\}) = \frac{1}{2} \left[-\partial_x^2 + \Omega^2(t; \{f\})x^2 \right], \quad -\infty < x < +\infty. \quad (3.1)$$

In expression (3.1) the frequency $\Omega(t; \{f\})$ is a random function of time where its stochastic component describes the influence of environment. For the analysis of a model of an environment a set of harmonic oscillators [21-25] and quantized field [26, 27] are often used. For simplicity, we will assume that frequency has the following form:

$$\Omega^2(t; \{f\}) = \Omega_0^2 + f(t), \quad \Omega_0 = const, \quad \lim_{t \rightarrow -\infty} f(t) = 0, \quad (3.2)$$

where $f(t)$ is an independent Gaussian stochastic process with a zero mean and δ is a shaped correlation function:

$$\langle f(t) \rangle = 0, \quad \langle f(t) f(t') \rangle = 2\lambda \delta(t - t'). \quad (3.3)$$

The constant of λ characterizes power of stochastic force $f(t)$. Equation (2.1) with operator (3.1) has an asymptotic solution $\Psi(n|x,t)$ in the limit $t \rightarrow -\infty$:

$$\Psi(n|x,t) = e^{-t(n+1/2)\Omega_0} \phi(n|x), \quad \phi(n|x) = \left[\frac{1}{2^n n!} \sqrt{\frac{\Omega_0}{\pi}} \right]^{1/2} e^{-\Omega_0 x^2/2} H_n(\sqrt{\Omega_0} x), \quad (3.4)$$

where $n=0,1,2,\dots$ in addition; $\phi(n|x)$ is the wave function of a stationary oscillator and $H_n(y)$ is the Hermitian polynomial. The formal solution of problem (2.1), (3.1)-(3.4) may be written down explicitly for arbitrary $\Omega(t; \{f\})$ (see [28]). It has the following form:

$$\Psi_{stc}(x,t|\{\xi\}) = \frac{1}{\sqrt{r(t)}} \exp\left\{ \frac{i r_t(t)}{2 r(t)} x^2 \right\} \chi\left(\frac{x}{r(t)}, \tau\right), \quad \xi = r(t) e^{i\gamma(t)}, \quad r_t(t) = \frac{dr(t)}{dt}, \quad (3.5)$$

where the function $\chi(y, \tau)$ describes the wave function of the Schrödinger equation:

$$i \partial_\tau \chi = \frac{1}{2} \left[-\partial_y^2 + \Omega_0^2 y^2 \right] \chi, \quad (3.6)$$

for a harmonic oscillator on the stochastic space-time $\{y, \tau\}$ continuum. In (3.6) the following designations are made:

$$y = x/r, \quad \tau = \gamma(t)/\Omega_0, \quad \gamma(t) = \int_{-\infty}^t dt' / r^2(t').$$

The random solution $\xi(t)$ satisfies the classical homogeneous equation of an oscillator which describes the stochastic fluctuating process flowing into FE:

$$\ddot{\xi} + \Omega^2(t; \{f\}) \xi = 0. \quad (3.7)$$

Taking into account (3.5) and the well-known solution of autonomous quantum harmonic oscillator (3.6) (see [28]) for stochastic complex processes which describe the 1D QHO+FE closed system, we can write the following expression:

$$\begin{aligned} \Psi_{stc}(n|x,t|\{\xi\}) = & \\ = & \left[\frac{1}{2^n n!} \sqrt{\frac{\Omega_0}{\pi r}} \right]^{1/2} \exp \left\{ -i \left(n + \frac{1}{2} \right) \Omega_0 \int_{t_0}^t \frac{dt'}{r^2(t')} + \frac{1}{2} \left(i \frac{r_t}{r} - \frac{\Omega_0}{r^2} \right) x^2 \right\} H_n \left(\sqrt{\frac{\Omega_0}{r}} \frac{x}{r} \right). \end{aligned} \quad (3.8)$$

The solution of (3.8) is defined in the extended space $\Xi = R^1 \otimes R_{\{\xi\}}$, where R^1 is the one-dimensional Euclidian space and $R_{\{\xi\}}$ is the functional space which will be defined below (see section 3.3). Note that wave function (3.8) (a more specific wave functional) describes the quantum subsystem with taking into account the influence of the environment. It is easy to show that complex probabilistic processes (3.8) consist of a full orthogonal basis in the space of quadratically integrable functions L_2 .

Taking into account the orthogonal properties of (3.8), we can write the following normalization condition:

$$\int_{-\infty}^{+\infty} \Psi_{stc}(n|x,t|\{\xi\})\Psi_{stc}^*(m|x,t|\{\xi\})dx = \delta_{nm}, \quad (3.9)$$

where the symbol "*" means complex conjugation.

So, the initial L-Sch equation (2.1) - (3.1) which satisfies the asymptotic condition (3.4) is reduced to autonomous Schrödinger equation (3.6) in the stochastic space-time using the *etalon differential equation* (3.7). Note that equation (3.7) with taking into account conditions (3.2) and (3.3) describes the motion of FE.

3.2 The mean values of measurable parameters of 1D QHO

For investigation of irreversible processes in quantum systems the non-stationary density matrix representation based on the quantum Liouville equation is often used. However, the application of this representation has restrictions [11]. It is used for the cases when the system before switching on the interaction was in the state of thermodynamic equilibrium and after switching on its evolution is adiabatic. Below, in the frames of the considered model the new approach is used for the investigation of the statistical properties of an irreversible quantum system without any restriction on the quantities and rate of interaction change. Taking into account definition (2.15), we can develop SDM method in the framework of which it is possible to calculate various measurable physical parameters of a quantum subsystem.

Definition 1. The expression for a stochastic function:

$$\rho_{stc}(x,t|\{\xi\}|x',t'|\{\xi'\}) = \sum_{m=1}^{\infty} w^{(m)}\rho_{stc}^{(m)}(x,t|\{\xi\}|x',t'|\{\xi'\}), \quad (3.10)$$

will be referred to as stochastic density matrix. Recall that the *partial* SDM $\rho_{stc}^{(m)}(x,t|\{\xi\}|x',t'|\{\xi'\})$ is defined by the expression: $\rho_{stc}^{(m)}(x,t|\{\xi\}|x',t'|\{\xi'\}) = \Psi_{stc}(m|x,t|\{\xi\})\Psi_{stc}^*(m|x,t|\{\xi'\})$. In addition, $w^{(m)}$ describes the level of population with the energy $E_m = (n+1/2)\Omega_0$ until the moment of time t_0 when the random excitations of FE are turned on. Integrating (3.10) over the Euclidean space $R^{(1)}$ with taking into account (3.9), we obtain the normalization condition for weight functions:

$$\sum_{m=1}^{\infty} w^{(m)} = 1, \quad w^{(m)} > 0. \quad (3.11)$$

Below we define the mean values of various operators. Note that at averaging over the extended space Ξ the order of integration is important. In the case when the integral from the stochastic density matrix is taken at first in the space, R^1 and then in the functional space, $R_{\{\xi\}}$ the result becomes equal to unity. This means that in the extended space Ξ all conservation laws are valid, in other words, the stochastic density matrix in this space is unitary. In the case when we take the integration in the inverse order, we get another

picture. After integration over, $R_{\{\xi\}}$ the obtained density matrix describes quantum processes in the Euclidean space, R^1 . Its trace is, in general, not unitary, which means that the conservation laws, generally speaking, can be invalid in the Euclidean space.

Definition 2. The expected value of the operator $\hat{A}(x, t|\{\xi\})$ in the quantum state m is defined by the expression:

$$A_m(\gamma) = \lim_{t \rightarrow +\infty} \left\{ N_m^{-1}(t) Tr_x \left[Tr_{\xi} \hat{A} \rho_{stc}^{(m)}(x, t|\{\xi\}|x', t'|\{\xi'\}) \right] \right\}, \quad N_m(t) = Tr_x \left[Tr_{\xi} \rho_{stc}^{(m)} \right]. \quad (3.12)$$

The mean value of the operator $\hat{A}(x, t|\{\xi\})$ over all quantum states, respectively, will be:

$$\bar{A}(\gamma) = \lim_{t \rightarrow +\infty} \left\{ N^{-1}(t) Tr_x \left[Tr_{\xi} \hat{A} \rho_{stc}(x, t|\{\xi\}|x', t'|\{\xi'\}) \right] \right\}, \quad N(t) = Tr_x \left[Tr_{\xi} \rho_{stc} \right]. \quad (3.13)$$

Note that the operation Tr_{ξ} in (3.12) and (3.13) denotes functional integration:

$$Tr_{\xi} \left[K(x, t|\{\xi\}|x', t'|\{\xi'\}) \right] = \sqrt{\Omega_0/\pi} \int K(x, t|\{\xi\}|x', t'|\{\xi'\}) D\mu(\xi), \quad (3.14)$$

where $D\mu(\xi)$ designates the measure of functional space which will be defined below.

If we wish to derive an expression describing the irreversible behavior of the system, it is necessary to change the definition of entropy. Let us remind that the von Neumann non-stationary entropy (the measure of randomness of a statistical ensemble) is defined by the following form:

$$\Lambda_N(\gamma, t) = -Tr_x \{ \rho \ln \rho \}, \quad N(\gamma) = \lim_{t \rightarrow +\infty} N(\gamma, t), \quad (3.15)$$

where $\rho(x, x'; t) = Tr_{\xi} \{ \rho_{stc} \}$ is a reduced density matrix, $\gamma = \Omega_0 / \lambda^{1/3}$ is an interaction parameter between the quantum subsystem and environment.

Let us note that the definition of the von Neumann entropy (3.15) is correct for the quantum information theory and agrees well with the Shannon entropy in the classical limit.

Definition 3. For the considered system of 1D QHO with FE the entropy is naturally defined by the form:

$$\Lambda_G(\gamma, t) = -Tr_x \left\{ Tr_{\{\xi\}} \left[\rho_{stc} \ln \rho_{stc} \right] \right\}, \quad \Lambda_G(\gamma) = \lim_{t \rightarrow +\infty} \Lambda_G(\gamma, t), \quad (3.16)$$

where the following designation $\rho_{stc} \equiv \rho_{stc}(x, x', t; \{\xi\})$ is made.

Finally, it is important to note that the sequence of integrations first in the functional space, $R_{\{\xi\}}$ and then in the Euclidean space, R^1 corresponds to non-unitary reduction of the vector's state (or non-unitary influence on the quantum subsystem).

3.3 Derivation of an equation for conditional probability of fields. Measure of functional space $R_{\{\xi\}}$

Let us consider the stochastic equation (3.7). We will present the solution of the equation in the following form:

$$\xi(t) = \begin{cases} \xi_0(t) = \exp(i\Omega_0 t), & t \leq t_0, \\ \xi_0(t_0) \exp\left(\int_{t_0}^t \boldsymbol{\eta}(t') dt'\right), & t > t_0. \end{cases} \quad (3.17)$$

After substitution of (3.17) into (3.7) we can define the following nonlinear SDE:

$$\dot{\boldsymbol{\eta}} + \boldsymbol{\eta}^2 + \Omega_0^2 + f(t) = 0, \quad \boldsymbol{\eta}(t_0) = i \dot{\xi}_0(t_0) / \xi_0(t_0) = i\Omega_0, \quad \dot{\boldsymbol{\eta}} = \partial_t \boldsymbol{\eta}. \quad (3.18)$$

The second equation in (3.18) expresses the condition of continuity of the function $\xi(t)$ and its first derivative at the moment of time $t=t_0$. Using the fact that the function $\boldsymbol{\eta}(t)$ describes a complex-valued random process, the SDE (3.18) may be presented in the form of two SDE for real-valued fields (random processes). Namely, introducing the real and imaginary parts of $\boldsymbol{\eta}(t)$:

$$\boldsymbol{\eta}(t) = u_1(t) + i u_2(t), \quad u_2(t) > 0, \quad (3.19)$$

the following system of SDEs can be finally obtained for the fields $\boldsymbol{\eta}(t) \equiv \boldsymbol{\eta}(u_1, u_2)$:

$$\begin{cases} \dot{u}_1 = -u_1^2 + u_2^2 - \Omega_0^2 - f(t) = 0, \\ \dot{u}_2 = -2u_1 u_2, \end{cases} \quad \begin{cases} u_1(t_0) = \text{Re}\left[\dot{\xi}_0(t_0) / \xi_0(t_0)\right] = 0, \\ u_2(t_0) = \text{Im}\left[\dot{\xi}_0(t_0) / \xi_0(t_0)\right] = \Omega_0. \end{cases} \quad (3.20)$$

The pair of fields (u_1, u_2) in this model is not independent because their evolution is influenced by the common random force $f(t)$. This means that the joint probability distribution of fields can be represented by the form:

$$P(\boldsymbol{\eta}, t | \boldsymbol{\eta}_0, t_0) = \left\langle \prod_{i=1}^2 \delta(u_i(t) - u_{0i}) \right\rangle, \quad u_{0i} \equiv u_i(t_0), \quad (3.21)$$

which is a non-factorable function. After differentiation of functional (3.21) with respect to time and using SDEs (3.18) and correlation properties of the random force (3.3), as well as making standard calculations and reasonings (see [29,30]), we obtain for a distribution of fields the following Fokker-Planck equation:

$$\partial_t P = \hat{L}(\boldsymbol{\eta}, t | \boldsymbol{\eta}_0, t_0) P, \quad (3.22)$$

$$\hat{L}(\boldsymbol{\eta}, t | \boldsymbol{\eta}_0, t_0) = \lambda \frac{\partial^2}{\partial u_1^2} + (u_1^2 - u_2^2 + \Omega_0^2) \frac{\partial}{\partial u_1} + 2u_1 u_2 \frac{\partial}{\partial u_2} + 4u_1, \quad (3.23)$$

with the initial condition:

$$P(u_1, u_2, t) \Big|_{t \rightarrow t_0} = \delta(u_1 - u_{01}) \delta(u_2 - u_{02}). \quad (3.24)$$

Thus, equation (3.22)-(3.23) describes the free evolution of FE.

Now, our purpose consists in constructing the measure of functional space, which is a necessary condition for further theoretical constructions. The solution of equation (3.22)-(3.23) for small time intervals can be presented in the form:

$$P(\boldsymbol{\eta}, t | \boldsymbol{\eta}', t') = \frac{1}{2\pi\sqrt{\lambda\Delta t}} \exp\left\{ \frac{1}{2\Delta t} \left[u_1 - u_1' - (u_1^2 - u_2^2 + \Omega_0^2(t))\Delta t \right]^2 \right\}, \quad t = t' + \Delta t. \quad (3.25)$$

So, we can state that the evolution of fields (u_1, u_2) in the functional space $R_{\{\xi\}}$ is characterized by regular displacement with the velocity $(u_1^2 - u_2^2 + \Omega_0^2)$ against the background of Gaussian fluctuations with the diffusion value λ . The infinitely small displacement of the trajectory $\boldsymbol{\eta}(t)$ in the space $R_{\{\xi\}}$ is determined by expression [30]:

$$\boldsymbol{\eta}(t + \Delta t) = \boldsymbol{\eta}(t) + (u_1^2 - u_2^2 + \Omega_0^2)\Delta t + f(t)\Delta t^{1/2}. \quad (3.26)$$

As follows from expression (3.26), the trajectory is continuous everywhere, and, correspondingly, the condition $\boldsymbol{\eta}(t + \Delta t)|_{\Delta t \rightarrow 0} = \boldsymbol{\eta}(t)$ is valid. However, expression (3.26) is undifferentiable everywhere owing to the presence of a term which is of the order $= \Delta t^{1/2}$. If we divide the time into small intervals, each of which being equal to $\Delta t = t/N$, where $N \rightarrow \infty$, then expression (3.25) can be interpreted as a probability of transition from $\boldsymbol{\eta}_k \equiv \boldsymbol{\eta}(t_k)$ to $\boldsymbol{\eta}_{k+1} \equiv \boldsymbol{\eta}(t_{k+1})$ during the time Δt in the process of Brownian motion. With consideration of the above, we can construct probability of fields' change on finite intervals of time or the measure of the space, $R_{\{\xi\}}$ (see [4]):

$$D\mu(\xi) \equiv D\boldsymbol{\eta} = D\mu(\boldsymbol{\eta}_0) \cdot \lim_{N \rightarrow \infty} \left[du_1(t_{k+1}) du_2(t_{k+1}) \left(\frac{1}{2\pi\sqrt{\lambda t}} \right)^N \right] \times \prod_{k=0}^N \exp \left\{ -\frac{N}{2\lambda t} \left[u_1(t_{k+1}) - u_1(t_k) - (u_1^2(t_{k+1}) - u_2^2(t_{k+1}) + \Omega_0^2) \frac{t_{k+1}}{N} \right]^2 \right\}, \quad (3.27)$$

where $D\mu(\boldsymbol{\eta}_0) = \delta(u_1 - u_{01})\delta(u_2 - u_{02})du_1 du_2$ (see condition (3.25)).

3.4 Entropy of the ground state of 1D QHO with fundamental environment

For simplicity we will suppose that $w^{(0)} = 1$ and, correspondingly, $w^{(m)} = 0$ for all quantum numbers $m > 1$ (see expression (3.10)). In this case the SDM (3.10) with consideration of expressions (3.8), (3.14) and (3.16) may be represented by the following form:

$$\rho_{stc}^{(0)}(x, x', t | \{\xi\}) = \sqrt{\frac{\Omega_0}{\pi}} e^A, \quad A = -\int_{t_0}^t u_1(t') dt' + \frac{i}{2} u_1(t)(x^2 - x'^2) - \frac{1}{2} u_2(t)(x^2 + x'^2), \quad (3.28)$$

where the following designation $\rho_{stc}^{(0)}(x, x', t | \{\xi\}) \equiv \rho_{stc}^{(0)}(x, t, \{\xi\} | x', t', \{\xi'\})|_{t=t'}$ is made.

Now, we can calculate the reduced density matrix: $\rho^0(x, x', t) = \text{Tr}_{\xi} \{ \rho_{stc}^{(0)}(x, x', t | \{\xi\}) \}$. Using expressions for the continuous measure (3.27) and stochastic density matrix (3.28) we can construct the corresponding functional integral which can be further calculated by the generalized Feynman-Kac formula (see Appendix 4.1, [6]):

$$\rho^0(x, x', t) = \sqrt{\frac{\Omega_0}{\pi}} \int_{-\infty}^{+\infty} du_1 \int_0^{+\infty} du_2 Q_0(u_1, u_2, t) \exp \left\{ \frac{i}{2} u_1(t)(x^2 - x'^2) - \frac{1}{2} u_2(t)(x^2 + x'^2) \right\}, \quad (3.29)$$

In expression (3.29) the function $Q_0(u_1, u_2, t)$ is a solution of the equation:

$$\partial_t Q_0 = [\hat{L}(u_1, u_2, t) - u_1] Q_0, \quad (3.30)$$

which satisfies the following initial and boundary conditions:

$$Q_0(u_1, u_2, t) \Big|_{t=t_0} = \delta(u_1 - u_{01}) \delta(u_2 - u_{02}), \quad Q_0(u_1, u_2, t) \Big|_{\|q\| \rightarrow \infty} = 0. \quad (3.31)$$

Let us consider the expression for the entropy (3.17). Substituting (3.29) into (3.17) we can find:

$$\Lambda_G^{(0)}(\gamma, t) = -\frac{1}{\sqrt{\pi}} \text{Tr}_x \left\{ \text{Tr}_{\{\xi\}} \left[A[u_1(t), u_2(t), t | x, x'] e^{A[u_1(t), u_2(t), t | x, x']} \right] \right\}. \quad (3.32)$$

After conducting integration in the space R^1 in (3.33), it is easy to find the expression:

$$\Lambda_G^{(0)}(\gamma) = -\partial_\alpha N_\alpha(t) \Big|_{\alpha=0}, \quad (3.33)$$

where the following designations are made:

$$N_\alpha(t) = \text{Tr}_\xi [I_\alpha(t; \{\xi\})], \quad I_\alpha(t; \{\xi\}) = u_2^{-1/2}(t) \exp \left[-(\alpha + 1) \int_{t_0}^t u_1(t') dt' \right]. \quad (3.34)$$

Similarly, as in the case with (3.29), using expressions (3.34) it is possible to calculate the functional trace in the expression $N_\alpha(t)$:

$$N_\alpha(t) = \int_{-\infty}^{+\infty} du_1 \int_0^{+\infty} du_2 \frac{1}{\sqrt{u_2}} Q_\alpha(u_1, u_2, t), \quad (3.35)$$

where the function $Q_\alpha(u_1, u_2, t)$ is the solution of the equation:

$$\partial_t Q_\alpha = [\hat{L}(u_1, u_2, t) - (\alpha + 1)u_1] Q_\alpha. \quad (3.36)$$

Recall that border conditions for (3.36) are similar to (3.31). Besides, if we assume that $\alpha = 0$ in (3.35), we will obtain the normalization function $N_0(t)$. After calculation of the function $Q_\alpha(u_1, u_2, t)$ we can also calculate the function $D_\alpha(u_1, u_2, t) \equiv \partial_\alpha Q_\alpha(u_1, u_2, t)$. In particular, it is easy to obtain an equation for $D_\alpha(u_1, u_2, t)$ by differentiation of equation (3.36) with respect to α :

$$\partial_t D_\alpha = [\hat{L}(u_1, u_2, t) - \alpha u_1] D_\alpha, \quad (3.37)$$

which is solved by initial and border conditions of type (3.31).

Introducing the designation $D_0(u_1, u_2, t) = D_\alpha(u_1, u_2, t) \Big|_{\alpha=0}$, it is possible to find the expression:

$$N_{0;0}(t) = \partial_\alpha N_\alpha(t) = \int_{-\infty}^{+\infty} du_1 \int_0^{+\infty} du_2 \frac{1}{\sqrt{u_2}} D_0(u_1, u_2, t). \quad (3.38)$$

Using (3.38) we can write the final form of the entropy of «ground state» in the limit of thermodynamics equilibrium:

$$\Lambda_G^{(0)}(\gamma) = -N_{0;0}(\gamma), \quad \gamma = \Omega_0 / \lambda^{1/3}. \quad (3.39)$$

It is simple to show that in the limit $\gamma \rightarrow \infty$ entropy aspires to zero.

Thus, at the reduction $\rho_{stc}(x, x', t | \{\xi\}) \rightarrow \rho(x, x', t)$ information in a quantum subsystem is lost, as a result of which the entropy changes, too. Let us remind that usually the entropy of a quantum subsystem at environment inclusion grows, however, in the considered case the behavior of the entropy depending on the interaction parameter γ can be generally nontrivial.

3.5 Energy spectrum of a quantum subsystem

The energy spectrum is an important characteristic of a quantum system. In the considered case we will calculate the first two levels of the energy spectrum in the limit of thermodynamic equilibrium. Taking into account expressions (3.12) and (3.28) for the energy of the «ground state», the following expression can be written:

$$E_{osc}^{(0)}(\gamma) = \lim_{t \rightarrow +\infty} \left\{ N_0^{-1}(t) Tr_x Tr_\xi \left[\hat{H}_0 \rho_{stc}(x, x', t | \{\xi\}) \right] \right\}, \quad (3.40)$$

where the operator:

$$\hat{H}_0 = \frac{1}{2} \left[-\partial_x^2 + \Omega_0^2 x^2 \right], \quad (3.41)$$

describes the Hamiltonian of 1D QHO without an environment.

Substituting (3.41) in (3.40) and after conducting simple calculations, we can find:

$$E_{osc}^{(0)}(\gamma) = \frac{1}{2} [1 + K_0(\gamma)] \Omega_0, \quad (3.42)$$

where the following designations are made:

$$K_0(\gamma) = \frac{1}{N_0(\gamma)} \int_{-\infty}^{+\infty} d\bar{u}_1 \int_0^{+\infty} d\bar{u}_2 \frac{1}{\sqrt{\bar{u}_2}} \left\{ -1 + \frac{\bar{u}_1^2 + \bar{u}_2^2 + \gamma^2}{2\gamma\bar{u}_2} \right\} Q_0(\bar{u}_1, \bar{u}_2, \gamma), \quad \bar{u}_{1,2} = u_{1,2} / \lambda^{1/3}. \quad (3.43)$$

In expression (3.43) the stationary solution $Q_0(\bar{u}_1, \bar{u}_2, \gamma) = \lim_{t \rightarrow +\infty} Q_0(\bar{u}_1, \bar{u}_2, t)$ is a scaling solution of equation (3.30) or (3.36) for the case where $\alpha = 0$. Similarly, it is possible to calculate the average value of the energy of any excited state. In particular, the calculation of the energy level of the first excited state leads to the following expression:

$$E_{osc}^{(1)}(\gamma) = \frac{3}{2} [1 + K_1(\gamma)] \Omega_0, \quad (3.44)$$

where

$$K_1(\gamma) = \frac{1}{N_1(\gamma)} \int_{-\infty}^{+\infty} d\bar{u}_1 \int_0^{+\infty} d\bar{u}_2 \frac{1}{\bar{u}_2^{3/2}} \left\{ -1 + \frac{\bar{u}_1^2 + \bar{u}_2^2 + \gamma^2}{2\gamma\bar{u}_2} \right\} Q_1(\bar{u}_1, \bar{u}_2, \gamma), \quad (3.45)$$

in addition:

$$N_1(\gamma) = \int_{-\infty}^{+\infty} d\bar{u}_1 \int_0^{+\infty} d\bar{u}_2 \frac{1}{\bar{u}_2^{3/2}} Q_1(\bar{u}_1, \bar{u}_2, \gamma). \quad (3.46)$$

In expression (3.45) the stationary solution $Q_1(\bar{u}_1, \bar{u}_2, \gamma) = \lim_{t \rightarrow +\infty} Q_1(\bar{u}_1, \bar{u}_2, t)$ is a scaling solution of equation (3.36) for the case where $\alpha=1$.

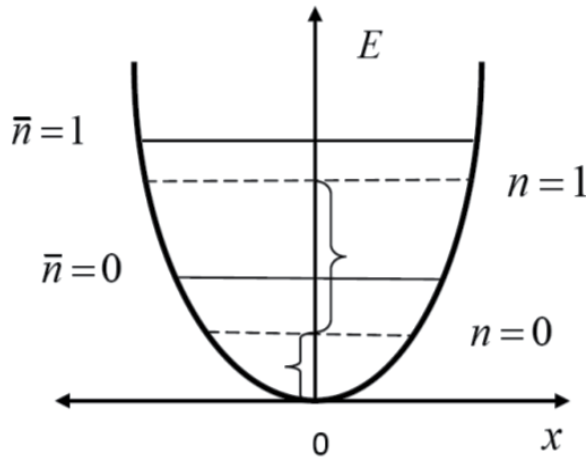

Fig. 1. The first two energy levels of quantum harmonic oscillator without of FE (see quantum numbers $\bar{n}=0,1,\dots$) and correspondingly with consideration of relaxation in the FE (see quantum numbers $n=0,1,\dots$).

As obviously follows from expressions (3.42)-(3.46), the relaxation effects lead to infringement of the principle of equidistance between the energy levels of a quantum harmonic oscillator Fig.1. In other words, relaxation of the quantum subsystem in fundamental environment leads to a shift of energy levels like the well-known Lamb shift.

3.6 Spontaneous transitions between the energy levels of a quantum subsystem

The question of stability of the energy levels of a quantum subsystem is very important. It is obvious that the answer to this question may be received after investigation of the problem of spontaneous transitions between the energy levels. Taking into account (3.4) and (3.8), we can write an expression for the probability of spontaneous transition between two different quantum states:

$$W_{n \rightarrow m}(\gamma) = |S_{nm}(\gamma)|^2, \quad S_{nm}(\gamma) = \lim_{t \rightarrow +\infty} \text{Tr}_x \text{Tr}_\xi \left\{ \Psi_{stc}(n|x, t|\{\xi\}) \Psi^*(m|x, t) \right\}, \quad (3.47)$$

where the wave function $\Psi(m|x, t)$ describes a pure state.

It is obvious that in the considered formulation of the problem there might occur transitions between any energy levels, including transitions from the «ground state» to any excited states. Using expression (3.47), we can calculate the spontaneous decay of every quantum state. In particular, if $w^{(0)}=1$ and $w^{(n)} \equiv 0$ for any $m \geq 1$, the probability of transition from the «ground state» to all other excited states may be calculated as follows:

$$\Sigma^0(\gamma) = \sum_{m=1} |S_{0m}(\gamma)|^2 = \sum_m \Delta_{0 \rightarrow m}(\gamma). \quad (3.48)$$

In (3.48) Σ^0 characterizes the population of the «ground state» in the limit of equilibrium thermodynamics. The first two nonzero probabilities of spontaneous transitions are calculated simply (see Appendix 4.2):

$$\begin{aligned} \Delta_{0 \rightarrow 2}(\gamma) &= \left| \int_{-\infty}^{+\infty} d\bar{u}_1 \int_0^{+\infty} d\bar{u}_2 \Theta(\bar{u}_1, \bar{u}_2, \gamma) \sigma_0(\bar{u}_1, \bar{u}_2, \gamma) \right|, \\ \Delta_{2 \rightarrow 0}(\gamma) &= \left| \int_{-\infty}^{+\infty} d\bar{u}_1 \int_0^{+\infty} d\bar{u}_2 \Theta(\bar{u}_1, \bar{u}_2, \gamma) \sigma_2(\bar{u}_1, \bar{u}_2, \gamma) \right|^2, \end{aligned} \quad (3.49)$$

where

$$\Theta(\bar{u}_1, \bar{u}_2, \gamma) = \frac{\sqrt{\gamma}}{\sqrt{\gamma - i\bar{u}_1 + \bar{u}_2}} \left\{ 1 - \frac{2\gamma}{\gamma - i\bar{u}_1 + \bar{u}_2} \right\}.$$

Let us note that in expressions (3.48) and (3.49) the functions $\sigma_0(\bar{u}_1, \bar{u}_2, \gamma)$ and $\sigma_2(\bar{u}_1, \bar{u}_2, \gamma)$ are solutions of the equation:

$$\partial_t \sigma_n(\bar{u}_1, \bar{u}_2, \gamma) = \left[\hat{L} - (1/2 + n)(\bar{u}_1 + \bar{u}_2) \right] \sigma_n(\bar{u}_1, \bar{u}_2, \gamma). \quad (3.50)$$

Comparing expressions (3.48) and (3.49) with taking into account the fact that equation (3.50) for a different number n has different solutions, $\sigma_n \neq \sigma_m$ if $n \neq m$, we can conclude that the detailed balance of transitions between different quantum levels is violated, i. e. $\Delta_{0 \rightarrow 2} \neq \Delta_{2 \rightarrow 0}$. Also, it is obvious that transitions between the quantum levels are possible if their parities are identical.

3.7 Uncertainty relations, Weyl transformation and Wigner function for the ground state

According to the Heisenberg uncertainty relations, the product of the coordinate and corresponding momentum of the quantum system cannot have arbitrarily small dispersions. This principle has been verified experimentally many times. However, at the present time for development of quantum technologies it is very important to find possibilities for overcoming this fundamental restriction.

As is well-known, the dispersion of the operator \hat{A}_i is determined by the following form:

$$\Delta \hat{A}_i(t) = \left\{ \text{Tr}_x \left(\rho \hat{A}_i^2(t) \right) - \left[\text{Tr}_x \left(\rho \hat{A}_i(t) \right) \right]^2 \right\}. \quad (3.51)$$

In the considered case the dispersion of the operator at the arbitrary time t in the «ground state» can be calculated by the following expression:

$$\Delta \hat{A}_i(t) = N_0^{-1}(t) \left\{ \text{Tr}_x \text{Tr}_\xi \left(\rho_{stc}^{(0)} \hat{A}_i^2(t) \right) - \left[\text{Tr}_x \text{Tr}_\xi \left(\rho_{stc}^{(0)} \hat{A}_i(t) \right) \right]^2 \right\}. \quad (3.52)$$

Using expression (3.52), we can calculate the dispersions of operators, the coordinate, \hat{x} and momentum, \hat{p} correspondingly:

$$\Delta \hat{x}(t) = \left\{ \frac{1}{N_0(t)} \int_{-\infty}^{+\infty} d\bar{u}_1 \int_0^{+\infty} d\bar{u}_2 \frac{1}{\bar{u}_2^{3/2}} Q_0(\bar{u}_1, \bar{u}_2, \gamma) \right\}^{1/2} = \sqrt{\frac{1}{2N_0(t)}} A_x(t), \quad (3.53)$$

$$\Delta \hat{p}(t) = \left\{ \frac{1}{N_0(t)} \int_{-\infty}^{+\infty} d\bar{u}_1 \int_0^{+\infty} d\bar{u}_2 \frac{\bar{u}_1^2 + \bar{u}_2^2}{\bar{u}_2^{3/2}} Q_0(\bar{u}_1, \bar{u}_2, t) \right\}^{1/2} = \sqrt{\frac{1}{2N_0(t)}} A_p(t). \quad (3.54)$$

The dispersions of operators at the moment of time t_0 , when the interaction with the environment is not switched on, is described with the standard Heisenberg relation: $\Delta \hat{x}(t) \Delta \hat{p}(t)|_{t=t_0} = 1/2$. The uncertainty relation for the large interval of time when the united system approaches thermodynamic equilibrium can be represented in the form:

$$\Delta \hat{x}_{st} \Delta \hat{p}_{st} = \lim_{t \rightarrow +\infty} [\Delta \hat{x}(t) \Delta \hat{p}(t)] = \frac{1}{2} \frac{A_x(\gamma) A_p(\gamma)}{N_0(\gamma)}, \quad (3.55)$$

where average values of operators $\hat{x}(\gamma)$ and $\hat{p}(\gamma)$ can be found from (3.53) and (3.54) in the limit $t \rightarrow +\infty$.

It is obvious that expressions for operator dispersions (3.53)-(3.54) are different from Heisenberg uncertainty relations and this difference can become essential at certain values of the interaction parameter γ . The last circumstance is very important since it allows controlling the fundamental uncertainty relations with the help of the γ parameter.

Definition 4. We will refer to the expression:

$$W_{stc}(p, x, t; \{\xi\}) = \sum_{m=1}^{+\infty} w^{(m)} W_{stc}(m | (p, x, t; \{\xi\})), \quad (3.56)$$

as stochastic Wigner function and, correspondingly, to $W_{stc}(m | p, x, t; \{\xi\})$ as partial stochastic Wigner function. In particular, for the partial stochastic Wigner function the following expression may be found:

$$W_{stc}(m|p, x, t; \{\xi\}) = \frac{1}{2} \int_{-\infty}^{+\infty} e^{ipv} \Psi_{stc}(m|x-v/2, t; \{\xi\}) \Psi_{stc}^*(m|x+v/2, t; \{\xi\}) dv. \quad (3.57)$$

Using the stochastic Wigner function, it is possible to calculate the mean values of the physical quantity, which corresponds to the operator \hat{A} :

$$\bar{A}(\lambda) = \lim_{t \rightarrow +\infty} \left\{ \frac{1}{N(t)} \int_{-\infty}^{+\infty} dp \int_{-\infty}^{+\infty} dx \text{Tr}_{\xi} \left[a(p, x, t; \{\xi\}) \rho_{stc}(x, x', t; \{\xi\}) \right] \right\}, \quad (3.58)$$

where the stochastic function $a(p, x, t; \{\xi\})$ is defined with the help of a Weyl transformation of the operator \hat{A} :

$$a(p, x, t; \{\xi\}) = \int_{-\infty}^{+\infty} e^{ipv} \Psi_{stc}(m|x-v/2, t; \{\xi\}) \hat{A} \Psi_{stc}^*(m|x+v/2, t; \{\xi\}) dv. \quad (3.59)$$

Now we can construct a Wigner function for the «ground state»:

$$W^{(0)}(x, p, t) = \frac{1}{2} \text{Tr}_{\xi} \left\{ W_{stc}(0|x, p, t; \{\xi\}) \right\} = \frac{1}{\sqrt{\pi}} \int_{-\infty}^{+\infty} d\bar{u}_1 \int_0^{+\infty} d\bar{u}_2 \frac{1}{\sqrt{\bar{u}_2}} Q_0(\bar{u}_1, \bar{u}_2, t) \exp \left\{ -\frac{(p - \bar{u}_1 x)^2 - (\bar{u}_2 x)^2}{\bar{u}_2} \right\}. \quad (3.60)$$

As one can see, function (3.61) describes distribution of the coordinate x and momentum p in the phase space. The Wigner stationary distribution function can be found in the limit of the stationary processes

$W^{(0)}(x, p, \gamma) = \lim_{t \rightarrow +\infty} W^{(0)}(x, p, t)$. It is important to note that in the similar to regular case after integration of the stochastic function $W_{stc}(m|p, x, t; \{\xi\})$ over the phase space; it is easy to get the normalization condition:

$$\int_{-\infty}^{+\infty} dx \int_{-\infty}^{+\infty} dp W_{stc}(m|x, p, t; \{\xi\}) = 1. \quad (3.61)$$

Recall that for the Wigner function (3.61) in the general case the normalization condition of type (6.12) is not carried out.

3.8 Conclusion

Any quantum system resulting from the fact that all beings are immersed into a physical vacuum is an open system [1-3]. A crucially new approach to constructing the quantum mechanics of a closed non-relativistic system QS+FE has been developed recently by the authors of [5-8], based on the principle of *local equivalence of Schrodinger representation*. More precisely, it has been assumed that the evolution of a quantum system is such that it may be described by the Schrödinger equation on any small time interval, while the motion as a

whole is described by a SDE for the wave function. However, in this case there arises a non-simple problem of how to find a measure of the functional space, which is necessary for calculating the average values of various parameters of the physical system.

We have explored the possibility of building the non-relativistic quantum mechanics of a closed system QS+FE within the framework of one-dimensional QHO which has a random frequency. Mathematically, the problem is formulated in terms of SDE for a complex-valued probability process (3.1) defined in the extended space $R^1 \otimes R_{\{\xi\}}$. The initial SDE for complex processes is reduced to the 1D Schrödinger equation for an autonomous oscillator on a random space-time continuum (3.6). For this purpose the complex SDE of Langevin type has been used. In the case when random fluctuations of FE are described by the white noise correlation function model, the Fokker-Plank equation for conditional probability of fields is obtained (3.22)-(3.23) using two real-valued SDE for fields (3.20). With the help of solutions of this equation, a measure of the functional space $R_{\{\xi\}}$ is constructed (3.27) on infinitely small time intervals (3.24). In the context of the developed approach representation of the stochastic density matrix is introduced, which allows perform an exact computation scheme of physical parameters of QHO (of a quantum subsystem) and also of fundamental environment after relaxation under the influence of QS. The analytic formulas for energies of the «ground state» and for the first excited state with consideration of shift (like the Lamb shift) are obtained. The spontaneous transitions between various energy levels were calculated analytically and violation of symmetry between elementary transitions up and down, including spontaneous decay of the «ground state», was proved. The important results of the work are the calculation of expressions for uncertainty relations and Wigner function for a quantum subsystem strongly interacting with the environment.

Finally, it is important to note that the developed approach is more realistic because it takes into account the shifts of energy levels, spontaneous transitions between the energy levels and many other things which are inherent to real quantum systems. The further development of the considered formalism in application to exactly solvable many-dimensional models can essentially extend our understanding of the quantum world and lead us to new nontrivial discoveries.

4. Appendix

4.1 Appendix 1

Theorem. Let us consider a set of random processes $\xi \equiv \{\xi_1, \xi_2, \dots, \xi_n\}$ satisfying the set of SDE:

$$\dot{\xi}_i = a_i(\xi, t) + \sum_{j=1}^n b_{ji}(\xi, t) f_j(t), \quad i = 1, 2, \dots, n,$$

where

$$\langle f_i(t) \rangle = 0, \quad \langle f_i(t) f_j(t') \rangle = \delta_{ij} \delta(t - t'), \quad (4.1.1)$$

so that the Fokker-Planck equation for the conditional transition probability density:

$$P^{(2)}(\xi_2, t_2 | \xi_1, t_1) = \langle \delta(\xi_2(t) - \xi_1) \rangle_{\xi(t_1) = \xi_1}, \quad t_2 > t_1, \quad (4.1.2)$$

is given by the equation:

$$\partial_t P^{(2)} = - \sum_{i=1}^n \frac{\partial}{\partial \xi_i} (a_i P^{(2)}) + \sum_{ijkl} \frac{\partial}{\partial \xi_i} \left(b_{li} \frac{\partial}{\partial \xi_k} (b_{kj} P^{(2)}) \right) \equiv \hat{L}^{(n)}(\xi) P^{(2)}. \quad (4.1.3)$$

ξ_i are assumed to be Markovian processes and satisfy the condition $\xi(t_0) \equiv \xi_0$. At the same time function (4.1.2) gives their exhaustive description:

$$P^{(n)}(\xi_n, t_n; \dots; \xi_1, t_1; \xi_0, t_0) = P^{(2)}(\xi_n, t_n; \xi_{n-1}, t_{n-1}) \dots P^{(2)}(\xi_1, t_1; \xi_0, t_0), \quad (4.1.4)$$

where $P^{(n)}$ is the density of the probability that the trajectory $\xi(t)$ would pass through the sequence of intervals $[\xi_1, \xi_1 + d\xi_1], \dots, [\xi_n, \xi_n + d\xi_n]$ at the subsequent moments of time $t_1 < t_2 < \dots < t_n$, respectively. Under these assumptions we can obtain the following representation for an averaging procedure:

$$\left\langle \exp \left\{ - \int_{t_0}^t V_1(\xi(t), \xi(\tau)) d\tau - V_2(\xi(t)) \right\} \right\rangle = \int d\xi e^{-V_2(\xi, t)} Q(\xi, \xi', t), \quad (4.1.5)$$

where $d\xi = d\xi_1 \dots d\xi_n$ and the function $Q(\xi, \xi', t)$ is a solution of the following parabolic equation:

$$\partial_t Q = [\hat{L}^{(n)}(\xi) - V_1(\xi, \xi', t)] Q, \quad (4.1.6)$$

which satisfies the following initial and boundary conditions:

$$Q(\xi, \xi', t) \xrightarrow{t \rightarrow t_0} \delta(t - t_0), \quad Q(\xi, \xi', t) \Big|_{|\xi| \rightarrow \infty} \rightarrow 0, \quad (4.1.7)$$

where $|\dots|$ is a norm in R^n .

Proof. The proof is performed formally under the assumption that all the manipulations are legal. We will expand into the Taylor series the quantity under the averaging in the left-hand side of (4.1.5):

$$I(t) = \sum_{n=0}^{+\infty} \frac{(-1)^n}{n!} \mu_n(t), \quad m = 0, 1, \dots, n, \quad (4.1.8)$$

where

$$\begin{aligned} \mu_n(t) &= \left\langle \left\{ \int_{t_0}^t V_1(\tau) d\tau + V_1(t) \right\}^n \right\rangle = \sum_{m=0}^{+\infty} \frac{n!}{m!(n-m)!} \left\langle V_2^{n-m}(t) \left\{ \int_{t_0}^t V_1(\tau) d\tau \right\}^m \right\rangle = \\ &= \sum_{m=0}^{+\infty} \frac{n!}{m!(n-m)!} \left\langle V_2^{n-m}(t) \int_{t_0}^t d\tau_m \int_{t_0}^{\tau_m} d\tau_{m-1} \dots \int_{t_0}^{\tau_2} d\tau_1 V_1(\tau_m) V_1(\tau_{m-1}) \dots V_1(\tau_2) \right\rangle. \end{aligned} \quad (4.1.9)$$

The designations $V_1(\tau) \equiv V_1(\xi(\tau), \xi(t))$ and $V_2(t) \equiv V_2(\xi(t))$ are introduced in (4.1.9) for brevity. Using the Fubini theorem, we can represent the averaging procedure in (4.1.9) as integration with the weight $P^{(n)}$ from (4.1.4):

$$\left\langle V_2^{n-m}(t) \int_{t_0}^t d\tau_m \int_{t_0}^{\tau_m} d\tau_{m-1} \dots \int_{t_0}^{\tau_2} d\tau_1 V_1(\tau_m) V_1(\tau_{m-1}) \dots V_1(\tau_2) \right\rangle = \int d\xi \int d\xi_m \dots \int d\xi_1 \int_{t_0}^{\tau_{m-1}} d\tau_m \dots \int_{t_0}^{\tau_2} d\tau_1 \times \\ P^{(2)}(\xi, t | \xi_m, \tau_m) P^{(2)}(\xi_m, \tau_m | \xi_{m-1}, \tau_{m-1}) \dots P^{(2)}(\xi_2, \tau_2 | \xi_1, \tau_1) V_2^{n-m}(\xi) V_1(\xi_m, \xi) \dots V_1(\xi_1, \xi).$$

Changing, where it is necessary, the order of integration, we can obtain the following representation for the n -th moment:

$$\mu_n(t) = \sum_{m=0}^n \frac{n!}{(n-m)!} \int d\xi V_2^{n-m}(\xi) Q_m(\xi, \xi', t), \quad (4.1.10)$$

where the countable set of functions $Q_m(\xi, \xi', t)$ is determined from the recurrence relations:

$$Q_m(\xi, \xi', t) = \int_{t_0}^t d\tau \int d\zeta V_2^{n-m}(\xi) P^{(2)}(\xi', t | \zeta, \tau) V_1(\zeta, \xi') Q_{m-1}(\zeta, \xi', \tau), \quad (4.1.11)$$

where

$$Q_0(\xi, \xi', t) = P^{(2)}(\xi, t | \xi_0, t_0), \quad (4.1.12)$$

i.e. the function Q_0 is, in fact, independent of ξ' . Upon substitution of (4.1.10) into (4.1.8) we insert the summation procedure under the integration sign and then, changing the order of double summation, get the expression:

$$I(t) = \int d\xi e^{-V_2(\xi, t)} Q(\xi, \xi', t), \quad (4.1.13)$$

where

$$Q(\xi, \xi', t) = \sum_{n=0}^{\infty} (-1)^n Q_n(\xi, \xi', t). \quad (4.1.14)$$

The representation (4.1.5) is thus obtained.

It remains to prove that the function Q from (4.1.13) is a solution of the problem (4.1.6) - (4.1.7). Using (4.1.14) and (4.1.11) we can easily show that Q satisfies the integral equation:

$$Q(\xi, \xi', t) + \int_{t_0}^t d\tau \int d\zeta P^{(2)}(\xi, t | \zeta, \tau) V_1(\zeta, \xi', \tau) Q(\zeta, \xi', \tau) = Q_0(\xi, t). \quad (4.1.15)$$

Taking into account the fact that Q_0 satisfies equation (4.1.3) with the initial and border conditions (4.1.7) and also that it is an integrable function, it is easy to deduce from equation (4.1.16) that the Q function coincides with the solution of the problem (4.1.6)-(4.1.7). Thus, the theorem is proved.

4.2 Appendix 2

Let us consider the bilinear form:

$$\mathfrak{I}(n, m, |x, t; \{\xi\}) = \Psi_{stc}(n | x, t | \{\xi\}) \Psi^*(m | x, t), \quad (4.2.1)$$

which can be represented, taking into account expressions (3.4) and (3.8), by the following form:

$$\begin{aligned} \mathfrak{I}(n, m, |x, t; \{\xi\}) = & \left(\frac{\Omega_0/\pi}{2^{n+m} n! m!} \right)^{1/2} [u_2(t)]^{-n/2} \exp \left\{ - \left(\frac{1}{2} + n \right) \int_{t_0}^t [u_1(t') + u_2(t')] dt' \right. \\ & \left. - \frac{1}{2} [-iu_1(t) + u_2(t) + \Omega_0] x^2 \right\} H_n(\sqrt{u_2(t)} x) H_m(\sqrt{\Omega_0} x). \end{aligned} \quad (4.2.2)$$

After conducting functional integration of the expression $\mathfrak{I}(n, m, |x, t; \{\xi\})$ by the generalized Feynman-Kac formula (see Appendix 4.1), it is possible to find:

$$\begin{aligned} \mathfrak{I}(n, m, |x, t; \{\xi\}) = \text{Tr}_{\{\xi\}} \{ \mathfrak{I}(n, m, |x, t; \{\xi\}) \} = & \left(\frac{\Omega_0/\pi}{2^{n+m} n! m!} \right)^{1/2} H_m(\sqrt{\Omega_0} x) \int_{-\infty}^{+\infty} d\bar{u}_1 \int_0^{+\infty} d\bar{u}_2 \times \\ & [\bar{u}_2]^{-n/2} \exp \left\{ - \frac{1}{2} [-iu_1(t) + u_2(t) + \Omega_0] x^2 \right\} H_n(\sqrt{u_2} x) X_n(u_1, u_2, t), \end{aligned} \quad (4.2.3)$$

where $X_n(u_1, u_2, t)$ is a solution of the complex equation:

$$\partial_t X_n(u_1, u_2, t) = [\hat{L} - (1/2 + n)(u_1 + iu_2)] X_n(u_1, u_2, t). \quad (4.2.4)$$

The solution of equation (4.4) is useful to represent in the following form:

$$X_n(u_1, u_2, t) = \sigma_n(u_1, u_2, t) + i\chi_n(u_1, u_2, t). \quad (4.2.5)$$

By substituting (4.2.5) into equation (4.2.4), it is possible to find the following two real-value equations for the real and complex parts of solution:

$$\begin{aligned} \partial_t \sigma_n(u_1, u_2, t) = & [\hat{L} - (1/2 + n)u_1] \sigma_n(u_1, u_2, t) + (1/2 + n)u_2 \chi_n(u_1, u_2, t), \\ \partial_t \chi_n(u_1, u_2, t) = & [\hat{L} - (1/2 + n)u_1] \chi_n(u_1, u_2, t) - (1/2 + n)u_2 \sigma_n(u_1, u_2, t). \end{aligned} \quad (4.2.6)$$

The system of equations is symmetric in regard to the replacements: $\sigma_n \rightarrow -\chi_n$ and $\chi_n \rightarrow -\sigma_n$. In other words, it means that for the solution $\sigma_n(u_1, u_2, t)$ it is possible to write the following equation:

$$\partial_t \sigma_n(u_1, u_2, t) = [\hat{L} - (1/2 + n)(u_1 + u_2)] \sigma_n(u_1, u_2, t). \quad (4.2.7)$$

Accordingly, for a complex solution $X_n(u_1, u_2, t)$ we can write the expression:

$$X_n(u_1, u_2, t) = (1 - i)\sigma_n(u_1, u_2, t) = -(1 - i)\chi_n(u_1, u_2, t). \quad (4.2.8)$$

Now it is possible to pass to the calculation of the amplitude of transition between different quantum states. For simplicity we will compute the first two probabilities of transitions:

$\Delta_{0 \rightarrow 2}$ and $\Delta_{2 \rightarrow 0}$. Integrating the expression $\Im(0,2,|x,t\rangle)$ over x with taking into account result (4.2.8), it is easy to find:

$$S_{0,2}(\gamma) = \lim_{t \rightarrow +\infty} \int_{-\infty}^{+\infty} \Im(0,2,|x,t\rangle) dx = \sqrt{\gamma} \int_{-\infty}^{+\infty} d\bar{u}_1 \int_0^{+\infty} d\bar{u}_2 \Theta(\bar{u}_1, \bar{u}_2, \gamma) \sigma_0(\bar{u}_1, \bar{u}_2, \gamma), \quad (4.2.9)$$

where $\sigma_0(\bar{u}_1, \bar{u}_2, \gamma)$ is the scaled solution of equation (4.2.7) in the limit $t \rightarrow +\infty$, in addition:

$$\Theta(\bar{u}_1, \bar{u}_2, \gamma) = (\gamma - i\bar{u}_1 + \bar{u}_2)^{-1/2} \left[1 - 2\gamma(\gamma - i\bar{u}_1 + \bar{u}_2)^{-1} \right]. \quad (4.2.10)$$

In a similar way it is possible to calculate the transition matrix element $S_{2,0}(\gamma)$:

$$S_{2,0}(\gamma) = \lim_{t \rightarrow +\infty} \int_{-\infty}^{+\infty} \Im(2,0,|x,t\rangle) dx = \sqrt{\gamma} \int_{-\infty}^{+\infty} d\bar{u}_1 \int_0^{+\infty} d\bar{u}_2 \Theta(\bar{u}_1, \bar{u}_2, \gamma) \sigma_2(\bar{u}_1, \bar{u}_2, \gamma). \quad (4.2.11)$$

As follows from expressions (4.2.9), (4.2.10) and (4.2.11), in the general case $S_{0,2}(\gamma) \neq S_{2,0}(\gamma)$.

5. Acknowledgment

This Chapter was prepared and written with the kind help of Ms. Elena Pershina.

6. References

- [1] Davtyan, O.K.; Theory of gravitational-inertial field of universe. IV. The universe and the microcosm. *Ann. Phys.* 36, 227–237 (1979)
- [2] Davtyan, O. K. & Karamyan, G.G.; Theories of Inertial Fields and of Quantum Correlations. *Academy of Science of Arm. SSR, Yerevan* (1987)
- [3] Milonni, P. W.; The Quantum Vacuum. *Academic Press, San Diego* (1994)
- [4] Bogdanov, A. V., Gevorkyan, A.S. & Grigoryan, A.G.; Random Motion of Quantum Harmonic Oscillator. Thermodynamics of Nonrelativistic Vacuum. *AMS/IP Studies in Advanced Mathematics*, 13, 81-111, (1999).
- [5] Bogdanov, A. V., Gevorkyan, A.S. & Udalov, A. A.; Thermodynamics of homogeneous and nonhomogeneous spaces in framework of representation by stochastic density matrix, *XXIII Internat. Colloquium on Group theoretical methods in Physics*, Vol. 2, pp. 419-429, Eds by A.N. Sisakian, A.N. Pogosyan & L.G. Mardoyan, (Dubna 2000): JINR.
- [6] Gevorkyan, A.S.; Exactly solvable models of stochastic quantum mechanics within the framework of Langevin-Schrödinger type equation. In: Barsegian, G. & Begehr, H. (eds.) *Analysis and Applications*, p. 415. NATO Science Publications, Brussels (2004)
- [7] Gevorkyan, A.S.; Exactly constructed model of quantum mechanics with random environment. *Phys. Atom. Nucl.* 73(N2), 311-319 (2010)
- [8] Gevorkyan, A.S.; Nonrelativistic quantum mechanics with fundamental environment, *Foundation of Physics* 41, 509-515 (2011). DOI 10.1007/s100701-010-9446-y.

- [9] Gevorkyan, A.S., Burdik, C. & Oganesyanyan, K.B.; Quantum harmonic oscillator subjected to quantum vacuum fluctuations, *Proceedings of AIP Conference N 1232*, pp. 251-258, ISBN 978-0-7354-07777-0, QTRF-5, Vaxjo Sweden July 16-20 (2010)
- [10] Klyatskin, V.I., Statistical Description of Dynamical Systems with Fluctuating Parameters (*Nauka, Moscow, 1975*) [in Russian].
- [11] Von Neumann, J.; Mathematical Foundations of Quantum Mechanics. *Princeton University Press, Princeton (1955)*
- [12] Encyclopedia of Mathematical Physics (*The Big Soviet Encyclopedia, Moscow, 1998*) [in Russian]
- [13] Gevorkyan, A. S., Karamyana, G. G. & Sargsyan, R. Sh.; Quantum-mechanical channel of interactions between macroscopic systems, *Proceedings of AIP Conference N 1232*, pp 267-274, ISBN 978-0-7354-07777-0, QTRF-5 Vaxjo Sweden, July 16-20,(2010)
- [14] Girardi, G.C., Rimini, A.&Weber, T.; Unified dynamics for microscopic and macroscopic systems. *Phys. Rev. D* 34, 470-477 (1986)
- [15] Itano, W.M., Heinzen, D. J., Bellinger, J. J. & Wineland, D. J.; Quantum Zeno effect, *Phys. Rev. A* 41, 2295 (1990)
- [16] Percival, C.; Quantum State Diffusion(*Cambridge Univ., Cambridge, 2000*)
- [17] Gorini, V., Kossakowski, A. & Sudarshan, C. G.; Completely positive dynamical semi-groups of N – level systems, *J.Math. Phys.*17, 821 (1976).
- [18] Lindblad, G.; On the generators of quantum dynamical semi-groups, *Commun. Math. Phys.*48, 119 (1976)
- [19] Weiss, U.; Quantum Dissipative Systems (*World Sci., Singapore, 1993*)
- [20] Gisin, N & Percival, I.C.; The quantum-state diffusion model applied to open system, *J. Phys. A*25, 5677 (1992)
- [21] Feynman, R.P. & Vernon, F.L., The theory of a general quantum system interacting with a linear dissipative system, *Jr., Ann. Phys. (N.Y.)* 24, 118 (1963)
- [22] Dekker, H.; Classical and Quantum Mechanics of the Damped Oscillator, *Phys. Rep.* 80, 1 (1981)
- [23] Caldeira, A. O. & Leggett, A.J.; Path integral approach to quantum Brownian motion, *Physica A*121, 587 (1983); Quantum tunneling in dissipative system, *Ann. Phys. (N.Y.)* 149, 374 (1983); Influence and damping on quantum interference: An exact solvable model, *Phys. Rev. A*31, 1059 (1985)
- [24] Jo'os, E. & Zeh, H. D.; The emergence of classical properties through interaction with environment, *Z. Phys. B* 59, 223 (1985)
- [25] Paz, J. P. & Zurek, W.H.; Environment-induced decoherence, classically and consistency of quantum histories, *Phys. Rev. D*48, 2728 (1993)
- [26] Unruh, W. G. & Zurek, W. H.; Reduction of the wavepacket in quantum Brownian motion, *Phys. Rev. D* 40, 1071 (1989)
- [27] Zurek, W. H.; Decoherence, chaos, quantum-classical correspondence, and the algorithmic arrow of time, *Phys. Scripta* 76, 186 (1998)
- [28] Baz', A.N., Zel'dovich, Ya.B. & Perelomov, A.M.; Scattering Reactions and Decays in Nonrelativistic Quantum Mechanics(*Nauka, Moscow, 1971*) [in Russian]
- [29] Lifshitz, I.M., Gredeskul, S.A. & Pastur, L.P.; Introduction to the Theory of Nonregular Systems (*Nauka, Moscow, 1982*) [in Russian]
- [30] Gardiner, C.W.; Handbook of Stochastic Methods for Physics, Chemistry and Natural Sciences (*Springer, Berlin, New York, Tokyo, 1985*)

- [31] Kudryavtsev, L. D.; Fubini theorem, Encyclopedia of Mathematics, Springer 2001, ISBN 978-155608104.

Non Commutative Quantum Mechanics in Time-Dependent Backgrounds

Antony Streklas

*Department of Mathematics, University of Patras, Patras
Greece*

1. Introduction

The problem of the dissipative systems from the quantum point of view has been of increasing interest, but it is far from having a satisfactory solution (1). There are many problems where the dissipation has an important role such as in quantum optics, in quantum analysis of fields, in quantum gravity (2). Dissipation can be observed in interactions between two systems, the observed system and another one often called reservoir or the bath, into which the energy flows via an irreversible manner (3). The system is embedded in some environment which is in principle unknown. For an effective description of such systems, we can use time dependent Hamiltonians which in classical physics yield the proper equation of motion. If the friction is a linear function of the velocity with friction constant γ the Hamiltonian is the well known Caldirola - Kanai Hamiltonian

$$\hat{\mathcal{H}} = \frac{1}{2m} e^{-\gamma t} \hat{p}^2 + V(\hat{q}) e^{\gamma t}$$

Some special potentials have been studied in reference (4). It should be noted however, that $\hat{\mathcal{H}}$ is not constant of motion and does not represent the energy of the system.

A second method for the dissipative systems, is based upon the procedure of doubling the phase space dimensions. The new degrees of freedom may assumed to represent the environment which absorb the energy dissipated by the dissipative system. H. Bateman (5) has shown that one can double the numbers of degrees of freedom so as to deal with an effective isolated system (6). In this article we assume that the coordinate operators q_1 and q_2 , of these two systems respectively do not commute, that is $[\hat{q}_1, \hat{q}_2] = i\theta$ where θ is a real parameter and plays an analogous role of \hbar in standard quantum mechanics.

For a manifold parametrized by the space - time coordinates x^μ , the commutation relations can be written as

$$[x^\mu, x^\nu] = i\theta^{\mu\nu}, \quad \mu, \nu = 0, \dots, d$$

where $\theta^{\mu\nu}$ is a real antisymmetric tensor. This relation gives rise to the following space - time uncertainty relations

$$(\Delta x^\mu) (\Delta x^\nu) \geq \frac{1}{2} |\theta^{\mu\nu}|$$

The space - time non commutativity however violates causality, although could be consistent in string theory (9). Field theories with only space non commutativity, that is $\theta^{0i} = 0$ have a unitary S matrix, on the other hand theories with space - time non commutativity $\theta^{0i} \neq 0$ are

not unitary. The non - commutativity of space, in the quantum field theory, appears through the modification of the product of the fields which appear in the action, by the so - called Moyal or star product (7),(8).

The idea of non commutative space - time was presented by Snyder (10) in 1947, with respect to the need to regularize the divergence of the quantum field theory. The idea was suggested by Heisenberg in 1930. It was Jon von Neumann , who began studying this "pointless geometry". The physical theories of today they hold only in empty space which in reality does not exist. The seed of the original idea goes back to ancient Greek Stoik Philosophers, especially to Zeno the Kitieus, who contrary to the followers of Democritus, said that there is not empty space (11).

In the past few years there has been an increasing interest in the non commutative geometry, extensively developed by Connes (12), for the study of many physical problems. It has become clear that there is a strong connection of these ideas with string theories (13), finding many applications in solid state and particles physics. The non commutative geometry arises very naturally from the Matrix theory (14).

There is another immediate motivation of noncommutative theories in quantum gravity. Classical general relativity breaks down at Planck scale l_p , where quantum effects become important.

$$l_p = \sqrt{\frac{\hbar G}{c^3}} \simeq 10^{-33} \text{ cm} \quad t_p = \frac{l_p}{c} \simeq 10^{-44} \text{ sec}$$

Einstein's theory implies that gravity is equivalent to spacetime geometry. Hence quantum gravity should quantize spacetime and spacetime quantization requires to promote coordinates to hermitian operators which do not commute. The wave function actually becomes an operator. The point is replaced by some "cell" and thus the spacetime becomes fuzzy at very short distances. It is apparent that this conflicts with Lorentz invariance. Physics near Planck dimensions is not yet fully understood. At these dimensions the cone of light acts as if it were fuzzy and we cannot distinguish between the past and the future. A review of recent efforts to add a gravitational field to non commutative models can be found in (15) and references therein.

Non commutativity is the central mathematical concept expressing the uncertainty. The phase space of ordinary quantum mechanics is a well known example of non commuting space. The momenta of a system in the presence of a magnetic field act as non commuting operators as well. The canonical commutation relations of quantum mechanics introduce a cellular structure in phase space. Noncommuting coordinates will introduce a cellular structure in ordinary space as well, similar to a lattice structure, which a priori lead to a nonlocal theory. This nonlocality however may be desirable since there are reasons to believe that any theory of quantum gravity will not be local in the conventional sense. Anyway it is a long - held belief that in quantum theories, space - time must change its nature at distances compared to the Planck scales.

The experimental signature of noncommuting spatial coordinates which is currently available seems to be the approximate noncommutativity appearing in the Landau problem, the lowest energy levels, for the case of very strong magnetic field. The study of exactly solvable models, as is for instance the present note, should lead to a better understanding of some issues in noncommutative theories.

In recent years there has been increasing interest in quantizing the harmonic oscillator with a variable mass in a time varying crossed electromagnetic field (16). In this article we will study the problem of a two dimensional time dependent harmonic oscillator within non

commutative quantum mechanics (17) (18), the parameters of which are also time dependent. All the time dependent factors are exponentials of the form $e^{\gamma t}$. These factors have been chosen so that the resulting final formulas, fluctuate with some external frequencies which do not depend on time.

We postulate first the two dimensional phase space. The momenta commutator shows that we have a time dependent magnetic field. With a time dependent, Bopp shift, linear transformation we reduce the phase space to a new phase space with two independent dimensions. The coordinates and the momentum of the second dimension of this new phase space satisfy a deformed time independent commutation relation. Next we give the Hamiltonian of the system which is a two dimensional damped harmonic oscillator. It is actually a linear combination of two Caldirola - Kanai damped harmonic oscillators with friction terms. Following that, we find the exact propagator of the system and the time evolution of the basic operators. In the next section we find the propagator in the case where the deformed parameter μ vanishes and the system becomes one dimensional. Finally in the last section we find the statistical partition function for two distinct particular cases which differ in the number of the dimensions but the final results depend on one common frequency.

2. The two dimensional phase space

We postulate the following time dependent commutation relations.

$$[\hat{p}_1, \hat{p}_2] = i\lambda e^{-\gamma_1 t}, \quad [\hat{q}_1, \hat{q}_2] = i\theta e^{\gamma_1 t}, \quad [\hat{q}_j, \hat{p}_k] = i\hbar\delta_{jk} \quad (1)$$

Recently non commutative theories with non constant parameters have been found in some references such as (19). The commutators of the pairs q_1, p_2 and q_2, p_1 are zero and the system can be described initially by one of the following wave functions $\psi(q_1, p_2, 0)$ or $\psi(q_2, p_1, 0)$.

The first relation among momenta operators means that the system is in a time dependent magnetic field, ($\lambda \sim B$), perpendicular to the plane of q_1 and q_2 . The magnetic field is defined in terms of the symmetric time dependent potential $\vec{A} = e^{-\gamma_1 t}(-Bq_2/2, Bq_1/2, 0)$, which indicates that there is also an electric field present.

$$\vec{B} = \vec{\nabla} \times \vec{A} = e^{-\gamma_1 t} B \vec{k} \quad \vec{E} = -\vec{\nabla}\phi - \frac{\partial \vec{A}}{\partial t} = \gamma_1 \vec{A}$$

The second commutation relation between the coordinates, expresses the non commutativity of space. The parameter θ has a dimension of (length)². In lowest Landau levels the coordinates of the plane are also canonical conjugate operators and so satisfies the same relation with $\theta \sim (1/B)$ (20). This commutation relation implies the following uncertainty.

$$\Delta q_1 \Delta q_2 \sim (\theta/2) e^{\gamma_1 t} \quad (2)$$

So the position of the system cannot be localized in space, except for minus infinite times. The coordinates space becomes now fuzzy and fluid. The parameter θ represents the fuzziness and the parameter γ_1 the fluidity of the space.

The above relation is the known relation of ordinary non commutative geometry except that the parameter $\theta \sim \theta(t)$ expands exponentially with the evolution of time. This is the main motivation of this paper. The effect of a changing magnetic field is given by Faraday's law which states that the magnetic flux running through a closed loop may change because the field itself changes or because the loop is moving in space. So if we focus on point one, that is

$\Delta q_1 \rightarrow \epsilon > 0$ then the second point becomes fuzzier as time passes, that is $\Delta q_2 \rightarrow \infty$. We can say that the background space is a dynamical two - dimensional fuzzy space (21).

We will transform the problem of the non commuting two dimensional space, to a problem of two coupled harmonic oscillators in a more familiar two dimensional quantum mechanical space. The two dimensions of the new phase space are now independent of each other, but the second phase space satisfies a deformed commutation relation.

For this purpose we make the following linear transformations

$$\begin{aligned} \hat{P}_1 &= \hat{p}_1 & \hat{Q}_1 &= \hat{q}_1 \\ \hat{P}_2 &= \hat{p}_2 + e^{-\gamma_1 t} \frac{\lambda}{\hbar} \hat{q}_1 & \hat{Q}_2 &= \hat{q}_2 - e^{\gamma_1 t} \frac{\theta}{\hbar} \hat{p}_1 \end{aligned} \quad (3)$$

The commutators for the basic operators within the capital letters are

$$\begin{aligned} [\hat{Q}_1, \hat{Q}_2] &= 0 & [\hat{P}_1, \hat{P}_2] &= 0 \\ [\hat{Q}_1, \hat{P}_1] &= i\hbar & [\hat{Q}_2, \hat{P}_2] &= i\left(\hbar - \frac{\lambda\theta}{\hbar}\right) = i\hbar\left(1 - \frac{\lambda\theta}{\hbar^2}\right) = i\hbar\mu \end{aligned} \quad (4)$$

The basic operators of the second dimension \hat{P}_2, \hat{Q}_2 satisfy a deformed commutation relation which it is time independent. We denote the deformed parameter by μ . We emphasize that the time dependence of the commutation relation in equations (1), are chosen so that this new parameter $\mu = 1 - (\lambda\theta/\hbar^2)$ becomes time independent. If this parameter becomes zero, $\mu = 0$ that is $\lambda\theta = \hbar^2$, the four - dimensional phase space degenerates to a two - dimensional one and consequently as we will see later, the final solutions depend only on one frequency Ω . The canonical limit ($\theta \rightarrow 0, \lambda \rightarrow 0$) does not exist in this case. It is clear that we have to keep both parameters non zero, $\lambda \neq 0$ and $\theta \neq 0$.

Instead of an algebra of commutators, some theoretical physicists (22),(23) consider its classical analogon involving Poisson brackets of functions on real variables. But the standard limit from quantum to classical mechanics that is $\hbar \rightarrow 0$ has as a result to vanish the third of the commutators (4), while the last one tends to infinity. So the noncommutative quantum mechanics seems to has no classical analogous or we have to treat the second phase spaces with some deferent manner as an extra dimension. It seems reasonable to make the substitutions $\theta \rightarrow \theta\hbar$ and $\lambda \rightarrow \lambda\hbar$ so that the limit $\hbar \rightarrow 0$ vanish all the commutators collectively.

We see that the time dependence on the magnetic field makes the time dependence of the coordinates commutator unavoidable, rendering the resulting commutator of the capital operators \hat{P}_2 and \hat{Q}_2 time independent. The system is now described initially on the coordinates space or on the momentum space by one of the following wave functions

$$\begin{aligned} \Psi_0(Q_1, Q_2) &= \Psi_0(q_1, q_2 - \frac{\theta}{\hbar} e^{\gamma_1 t} p_1), \\ \Psi_0(P_1, P_2) &= \Psi_0(p_1, p_2 + \frac{\lambda}{\hbar} e^{-\gamma_1 t} q_1) \end{aligned} \quad (5)$$

The time dependence of the initial wave functions is due to the moving phase space of the second point (Q_2, P_2) , resulting from the time dependent magnetic field.

3. The damped Hamiltonian of the system

We will use the following Hamiltonian

$$\hat{\mathcal{H}}(\hat{p}, \hat{q}, t) = e^{2(\gamma_1 + \gamma_2)t} \frac{\hat{p}_1^2}{2m_1} + e^{-2(\gamma_1 + \gamma_2)t} \frac{1}{2} m_1 \omega_1^2 \hat{q}_1^2 - \kappa \left(e^{-2\gamma_2 t} \frac{\hat{p}_2^2}{2m_2} + e^{2\gamma_2 t} \frac{1}{2} m_2 \omega_2^2 \hat{q}_2^2 \right) \quad (6)$$

which is usually referred to as the Caldirola - Kanai model (24). The coupling constant κ will take one of the values ± 1 . For $\kappa = -1$ the Hamiltonian is an ordinary two dimensional Hamiltonian. For $\kappa = 1$ we can say that the second Hamiltonian is an harmonic oscillator with negative mass $m_2 < 0$ (25).

The damped harmonic oscillator in a crossed magnetic field in ordinary space has been studied by many authors (26). We will study this problem in non commutative quantum mechanics. Such problems with magnetic fields in noncommutative quantum mechanics has also been studied by some authors see for instance (27), (28), and references there in.

We can assume that this is a Hamiltonian of two particles, one on the phase point (q_1, p_1) and the other on the point (q_2, p_2) . It has been shown, by Bateman, that we can apply the usual canonical quantization method if we double the numbers of degrees of freedom so as to deal with an effective isolated system. The new degrees of freedom may be assumed to represent the environment which absorbs the energy dissipated by the dissipative system and the time dependent magnetic fields. The canonical quantization of these dual Beteman's type systems have many problems which have been pointed out in the relevant literature (29). We think that the non vanishing commutator of the coordinate operators q_1 and q_2 , corrects many of these problems. Notice that as it was pointed out earlier, the Caldirola - Kanai Hamiltonian is not really the energy of the system but rather an operator which generates the motion of the system.

For the case where $\gamma_1 = 0$ the Hamiltonian becomes symmetric or antisymmetric with the reversal of time. This case has been studied in ref (31). The presence of the γ_1 parameter obviously breaks down this very important symmetry and indicates the presence of an electric field.

The Hamiltonian (6) describes a system of two particles with varying masses of $m_1 \rightarrow m_1 e^{-2(\gamma_1 + \gamma_2)t}$ and $m_2 \rightarrow m_2 e^{2\gamma_2}$ respectively. The product of these two masses is obviously time dependent

$$m_1 m_2 \rightarrow m_1 m_2 e^{-2\gamma_1 t} \quad (7)$$

This is the consequence of the time varying magnetic field $B(t) \rightarrow B e^{-\gamma_1 t}$. The time factors of this Hamiltonian have been chosen so that the finally oscillators of the system become time independent.

With the linear transformation (3) the Hamiltonian becomes

$$\begin{aligned} \hat{\mathcal{H}}(\hat{P}, \hat{Q}, t) = & \frac{1}{2} e^{2(\gamma_1 + \gamma_2)t} \hat{P}_1^2 (1 - \kappa \omega_2^2 \theta^2) + \frac{1}{2} e^{-2(\gamma_1 + \gamma_2)t} \hat{Q}_1^2 (\omega_1^2 - \kappa \lambda^2) - \\ & \frac{1}{2} e^{-2\gamma_2 t} \kappa \hat{P}_2^2 - \frac{1}{2} e^{2\gamma_2 t} \kappa \omega_2^2 \hat{Q}_2^2 - e^{(\gamma_1 + 2\gamma_2)t} \kappa \omega_2^2 \theta \hat{P}_1 \hat{Q}_2 + e^{-(\gamma_1 + 2\gamma_2)t} \kappa \lambda \hat{P}_2 \hat{Q}_1 \end{aligned} \quad (8)$$

where we have set $\hbar = 1$ and $m_1 = m_2 = 1$.

This is a Hamiltonian of two coupled harmonic oscillators in the deformed quantum mechanical space. The last two factors of the above Hamiltonian are the coupling terms. Notice that if $\gamma_1 + 2\gamma_2 = 0$ these terms become time independent.

In order to simplify the relations we shall use the following symbolism

$$\hat{P}_1 \rightarrow \hat{T}_1 \quad \hat{Q}_1 \rightarrow \hat{T}_2 \quad \hat{P}_2 \rightarrow \hat{T}_3 \quad \hat{Q}_2 \rightarrow \hat{T}_4 \quad (9)$$

The commutation relations become

$$[\hat{T}_2, \hat{T}_1] = c_{21} \quad [\hat{T}_4, \hat{T}_3] = c_{43}, \quad c_{21} = i\hbar \quad c_{43} = c_{21}\mu \quad (10)$$

while all the others commutators vanish. The last commutation relation goes to infinity as $\hbar \rightarrow 0$ so the problem has no classical analogy (Figure 1).

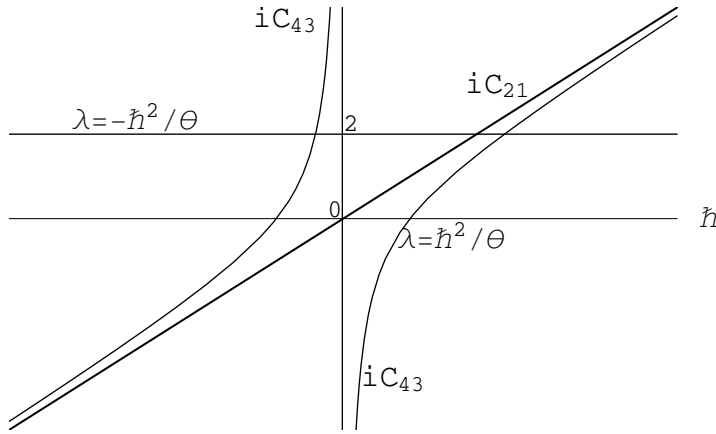

Fig. 1. The commutators $i c_{21}$ and $i c_{43}$ of the phase space as functions of \hbar .

The Hamiltonian is written

$$\hat{\mathcal{H}}(\hat{T}) = k_{11}\hat{T}_1^2 + k_{22}\hat{T}_2^2 + k_{33}\hat{T}_3^2 + k_{44}\hat{T}_4^2 + k_{41}\hat{T}_4\hat{T}_1 + k_{32}\hat{T}_3\hat{T}_2 \quad (11)$$

Where we have set

$$\begin{aligned} k_{11} &= \frac{1}{2} e^{2(\gamma_1+\gamma_2)t} (1 - \kappa\omega_2^2\theta^2), & k_{22} &= \frac{1}{2} e^{-2(\gamma_1+\gamma_2)t} (\omega_1^2 - \kappa\lambda^2) \\ k_{33} &= -\frac{1}{2} e^{-2\gamma_2t}, & k_{44} &= -\frac{1}{2} e^{2\gamma_2t} \kappa\omega_2^2 \\ k_{32} &= e^{-(\gamma_1+2\gamma_2)t} \kappa\lambda, & k_{41} &= -e^{(\gamma_1+2\gamma_2)t} \kappa\omega_2^2\theta \end{aligned} \quad (12)$$

The coupling terms k_{32} and k_{41} become zero in the case of commutative quantum mechanics, where $\lambda \rightarrow 0$ and $\theta \rightarrow 0$.

4. The exact propagator of the system

We will expand the time evolution operator in an appropriate ordered form so that the propagator will be calculated easily with a straight manner.

The Shrödinger equation of motion of the time evolution operator is:

$$i\hbar \frac{\partial}{\partial t} \hat{U}(t) = \hat{\mathcal{H}}(t) \hat{U}(t) \quad \hat{U}(0) = 1$$

We look for the following, normal ordered expansion of the evolution operator:

$$\hat{U}(t) = \hat{U}_4 \hat{U}_3 \hat{U}_2 \hat{U}_1$$

where

$$\begin{aligned} \hat{U}_4 &= e^{f_{44} \hat{T}_4^2} e^{\frac{1}{2} f_{43} (\hat{T}_4 \hat{T}_3 + \hat{T}_3 \hat{T}_4)} e^{f_{42} \hat{T}_4 \hat{T}_2} e^{f_{41} \hat{T}_4 \hat{T}_1} & \hat{U}_3 &= e^{f_{33} \hat{T}_3^2} e^{f_{32} \hat{T}_3 \hat{T}_2} e^{f_{31} \hat{T}_3 \hat{T}_1} \\ \hat{U}_2 &= e^{f_{22} \hat{T}_2^2} e^{\frac{1}{2} f_{21} (\hat{T}_2 \hat{T}_1 + \hat{T}_1 \hat{T}_2)} & \hat{U}_1 &= e^{f_{11} \hat{T}_1^2} \end{aligned} \quad (13)$$

The functions $f_{jk}(t)$ are time dependent and because of the condition $\hat{U}(0) = 1$, they satisfy the initial conditions $f_{jk}(0) = 0$.

The above solution is always possible if the Hamiltonian takes the following form $\hat{\mathcal{H}} = \sum_{i=1}^m a(t) \hat{H}_i$ where the operators \hat{H}_i , $i = 1, \dots, m$ forms a closed Lie algebra (30). We have proved in reference (32) using standard algebraic technics that all the unknown functions f_{jk} can be written with the help of the functions $x_{jk}(t)$. The functions $x_{jk}(t)$ satisfy the following classical differential system

$$\begin{aligned} x'_{1j} &= -2k_{11}x_{2j} + \mu k_{41}x_{3j} \\ x'_{2j} &= 2k_{22}x_{1j} - \mu k_{32}x_{4j} \\ x'_{3j} &= k_{32}x_{1j} - 2\mu k_{33}x_{4j} \\ x'_{4j} &= -k_{41}x_{2j} + 2\mu k_{44}x_{3j} \end{aligned} \quad (14)$$

with the following initial conditions

$$x_{jk}(0) = \delta_{jk} \quad (15)$$

The functions x_{nj} give the time evolution of the basic operators \hat{T}_j . We have

$$\hat{T}_n(t) = e^{-\frac{i}{\hbar} t \hat{\mathcal{H}}} \hat{T}_j(0) e^{\frac{i}{\hbar} t \hat{\mathcal{H}}} = x_{nj}(t) \hat{T}_j(0) \quad (16)$$

The solution of the above system is as follows

$$\begin{aligned} x_{11} &= e^{(\gamma_1 + \gamma_2)t} \left[a_2 - (\gamma_1 + \gamma_2)b_2 - \kappa^2 \omega_2^2 \mu (a_1 - (\gamma_1 \mu + \gamma_2)b_1) \right] \\ x_{22} &= e^{-(\gamma_1 + \gamma_2)t} \left[a_2 + (\gamma_1 + \gamma_2)b_2 - \kappa^2 \omega_2^2 \mu (a_1 + (\gamma_1 \mu + \gamma_2)b_1) \right] \\ x_{21} &= e^{(\gamma_1 + \gamma_2)t} \left[\kappa^2 \omega_2^2 \mu^2 b_1 - b_2 + \kappa \omega_2^2 \theta^2 b_2 \right] \\ x_{12} &= e^{-(\gamma_1 + \gamma_2)t} \left[-\omega_1^2 (\kappa^2 \omega_2^2 \mu^2 b_1 - b_2) - \kappa \lambda^2 b_2 \right] \end{aligned}$$

$$\begin{aligned}
x_{13} &= e^{-\gamma_2 t} \left[\omega_2^2 \left(\kappa^2 \lambda \mu^2 b_1 - \kappa \theta \mu (\gamma_1 (a_1 + \gamma_2 b_1) + b_2) \right) \right] \\
x_{14} &= e^{\gamma_2 t} \left[-\kappa \mu \lambda (a_1 - \gamma_2 b_1) + \kappa^2 \omega_2^2 \theta \mu (a_1 - (\gamma_1 \mu + \gamma_2) b_1) \right] \\
x_{23} &= e^{-\gamma_2 t} \left[\omega_2^2 \left(\kappa \omega_1^2 \theta \mu (a_1 + \gamma_2 b_1) - \kappa^2 \lambda \mu (a_1 + (\gamma_1 \mu + \gamma_2) b_1) \right) \right] \\
x_{24} &= e^{\gamma_2 t} \left[\kappa^2 \omega_1^2 \omega_2^2 \theta \mu^2 b_1 + \kappa \lambda \mu (\gamma_1 (a_1 - \gamma_2 b_1) - b_2) \right] \\
x_{31} &= e^{(\gamma_1 + \gamma_2) t} \left[-\kappa^2 \omega_1^2 \omega_2^2 \theta \mu b_1 + \kappa \lambda (\gamma_1 (a_1 + \gamma_2 b_1) + b_2) \right] \\
x_{32} &= e^{-(\gamma_1 + \gamma_2) t} \left[\kappa \lambda (a_1 + \gamma_2 b_1) - \kappa^2 \omega_2^2 \theta (a_1 + (\gamma_1 \mu + \gamma_2) b_1) \right] \\
x_{41} &= e^{(\gamma_1 + \gamma_2) t} \left[-\omega_2^2 \left(\kappa \omega_1^2 \theta (a_1 - \gamma_2 b_1) - \kappa^2 \lambda (a_1 - (\gamma_1 \mu + \gamma_2) b_1) \right) \right] \\
x_{42} &= e^{-(\gamma_1 + \gamma_2) t} \left[-\omega_2^2 \left(\kappa^2 \lambda \mu b_1 + \kappa \theta (\gamma_1 (a_1 - \gamma_2 b_1) - b_2) \right) \right] \\
x_{33} &= e^{-\gamma_2 t} \left[a_2 + \gamma_2 b_2 + \left(\gamma_1^2 + 2\gamma_1 \gamma_2 - \omega_1^2 + \kappa \omega_1^2 \omega_2^2 \theta^2 + \kappa \lambda^2 \right) (a_1 + \gamma_2 b_1) - \right. \\
&\quad \left. \kappa^2 \omega_2^2 (1 - \mu) (a_1 + (\gamma_1 \mu + \gamma_2) b_1) \right] \\
x_{44} &= e^{\gamma_2 t} \left[a_2 - \gamma_2 b_2 + \left(\gamma_1^2 + 2\gamma_1 \gamma_2 - \omega_1^2 + \kappa \omega_1^2 \omega_2^2 \theta^2 + \kappa \lambda^2 \right) (a_1 - \gamma_2 b_1) - \right. \\
&\quad \left. \kappa^2 \omega_2^2 (1 - \mu) (a_1 - (\gamma_1 \mu + \gamma_2) b_1) \right] \\
x_{43} &= e^{-\gamma_2 t} \left[-\omega_2^2 \left(\kappa^2 \lambda^2 \mu b_1 + \kappa \mu ((\gamma_1^2 + 2\gamma_1 \gamma_2 - \omega_1^2) b_1 + b_2) \right) \right] \\
x_{34} &= e^{\gamma_2 t} \left[\kappa^2 \omega_1^2 \omega_2^2 \theta^2 \mu b_1 + \kappa \mu ((\gamma_1^2 + 2\gamma_1 \gamma_2 - \omega_1^2) b_1 + b_2) \right]
\end{aligned}$$

Where

$$\begin{aligned}
a_1 &= \frac{1}{w_3} (\cos(\Omega_1 t) - \cos(\Omega_2 t)) & b_1 &= \frac{1}{w_3} \left(\frac{\sin(\Omega_1 t)}{\Omega_1} - \frac{\sin(\Omega_2 t)}{\Omega_2} \right) \\
a_2 &= \frac{1}{w_3} \left((\gamma_2^2 + \Omega_1^2) \cos(\Omega_1 t) - (\gamma_2^2 + \Omega_2^2) \cos(\Omega_2 t) \right) \\
b_2 &= \frac{1}{w_3} \left((\gamma_2^2 + \Omega_1^2) \frac{\sin(\Omega_1 t)}{\Omega_1} - (\gamma_2^2 + \Omega_2^2) \frac{\sin(\Omega_2 t)}{\Omega_2} \right)
\end{aligned} \tag{17}$$

The frequencies Ω_1 and Ω_2 are the solution of the following algebraic system

$$w_1 = (\gamma_2^2 + \Omega_1^2) (\gamma_2^2 + \Omega_2^2) = \kappa^2 \omega_2^2 \mu (\omega_1^2 \mu - \gamma_1 (\gamma_1 \mu + 2\gamma_2)) \tag{18}$$

$$w_2 = (\gamma_2^2 + \Omega_1^2) + (\gamma_2^2 + \Omega_2^2) = \omega_1^2 + \kappa^2 \omega_2^2 - \kappa (\omega_1^2 \omega_2^2 \theta^2 + \lambda^2) - \gamma_1 (\gamma_1 + 2\gamma_2) \tag{19}$$

We have also set

$$w_3 = \Omega_1^2 - \Omega_2^2 = \sqrt{w_2^2 - 4w_1} \tag{20}$$

We finally find the following solutions which are time independent.

$$\Omega_1 = \pm \sqrt{(w_2 + w_3)/2 - \gamma_2^2} \quad \Omega_2 = \pm \sqrt{(w_2 - w_3)/2 - \gamma_2^2} \tag{21}$$

The above results are valid for any particular value of the parameters with the exception of the parameters λ and θ which must be real. The solutions (eqs. 17) have well defined limits when $\Omega_1 \rightarrow 0$ and $\Omega_2 \rightarrow 0$, or for the more interesting limit $\Omega_1 \rightarrow 0$ and $\Omega_2 \rightarrow \pm i\gamma_2$.

The results found in this paper, coincide with that of paper (31) when $\gamma_1 = 0$, where we have a constant magnetic field. For this zero value of parameter γ_1 , equation (18) becomes symmetric, which means that it has two solutions with respect to μ , of opposite signs. This symmetry is present again if $\gamma_2 = 0$. This symmetry of the μ parameter is crucial, since it is the deformed parameter of the second phase space (equation 4) and the transformation $\mu \rightarrow -\mu$ means that $[\hat{Q}_2, \hat{P}_2] \rightarrow -[\hat{Q}_2, \hat{P}_2]$.

We can reconstruct the same symmetry also if we set

$$\gamma_1\mu + 2\gamma_2 = 0 \quad \implies \quad (\gamma_2^2 + \Omega_1^2) (\gamma_2^2 + \Omega_1^2) = \kappa^2\omega_1^2\omega_2^2\mu^2 \quad (22)$$

In this case we find

$$\gamma_1 + \gamma_2 = \frac{2 - \mu}{\mu} \quad \gamma_2 = \frac{\hbar + \frac{\lambda\theta}{\hbar}}{\hbar - \frac{\lambda\theta}{\hbar}} \gamma_2 \quad (23)$$

This term which is on the exponential of the first Hamiltonian in eq. (6), changes sign in the duality $\hbar \rightarrow \lambda\theta/\hbar$. For all the above symmetric cases equation (18) has two solutions with respect to μ with opposite signs.

In general equation (18) is a parabola with respect to μ and becomes zero for the following two values of the deformed parameter μ .

$$\mu = 0 \quad \implies \quad \lambda = \frac{1}{\theta} \quad \text{and} \quad \mu = \frac{2\gamma_1\gamma_2}{\omega_1^2 - \gamma_1^2} \quad \implies \quad \lambda = \frac{1}{\theta} \left(1 - \frac{2\gamma_1\gamma_2}{\omega_1^2 - \gamma_1^2} \right) \quad (24)$$

In both cases the frequencies are identical if $\omega_1^2 = \gamma_1^2 + \gamma_1\gamma_2$.

We will solve the case where $\mu = 0$ in the next paragraph because it leads to the relation $[\hat{Q}_2, \hat{P}_2] = 0$ which means that the problem is one dimensional since the commutator of the second phase space vanishes.

When $\omega_1 = \pm \gamma_1$ equation (18) has only one solution, with respect to μ , We find

$$\mu = -\frac{(\gamma_2^2 + \Omega_1^2) (\gamma_2^2 + \Omega_1^2)}{2\kappa^2\gamma_1\gamma_2\omega_2^2} \quad (25)$$

while the second solution tends to minus infinity.

Next we will calculate the exact propagator of the system.

As is well known the action of the time evolution operator on the delta function, produces the propagator of the system.

$$G(\tau_1, \tau'_1, \tau_2, \tau'_2, t) = \hat{U}(t)\delta(\tau_1 - \tau'_1)\delta(\tau_2 - \tau'_2) \quad (26)$$

Because of the commutation relations (10) only two quantities can be simultaneously measured. We choose the following observables

$$\hat{T}_2 = \hat{Q}_1 = q_1 \rightarrow \tau_1 \quad \hat{T}_4 = \hat{Q}_2 = q_2 - \frac{\theta}{\hbar} e^{\gamma_1 t} p_1 \rightarrow \tau_2 \quad (27)$$

For the calculations we consider the following representation

$$\hat{T}_1 = -c_{21}\partial_{\tau_1} \quad \hat{T}_2 = \tau_1 \quad \hat{T}_3 = -c_{43}\partial_{\tau_2} \quad \hat{T}_4 = \tau_2 \quad (28)$$

We can of course choose another couple of commuting observable. The various propagators are appropriate Fourier transforms of each other.

By the help of the above representation, and after a simple calculation (32) we find the propagator:

$$G(\tau_1, \tau'_1, \tau_2, \tau'_2, t) = \frac{1}{\sqrt{s_0}} \exp \left\{ -\frac{1}{2s_0} \left[c_{43}(2\tau_1 \tau'_1 x_{34} + \tau_1'^2(x_{14}x_{31} - x_{11}x_{34}) + \tau_1^2(x_{24}x_{32} - x_{22}x_{34})) + c_{21}(2\tau_2 \tau'_2 x_{12} + \tau_2'^2(x_{13}x_{32} - x_{12}x_{33}) + \tau_2^2(x_{14}x_{42} - x_{12}x_{44})) - 2c_{21} \tau_1'(\tau_2 x_{14} - \tau_2'(x_{14}x_{33} - x_{13}x_{34})) - 2c_{43} \tau_1(\tau_2' x_{32} + \tau_2(x_{34}x_{42} - x_{32}x_{44})) \right] \right\} \quad (29)$$

where

$$s_0 = c_{21}c_{43} (x_{12}x_{34} - x_{14}x_{32}) \quad (30)$$

If we find the propagator we can calculate the time evolution of a quantum system which must have initially the following form.

$$\psi(\tau_1, \tau_2, t)|_{t=0} = \psi_0(q_1, q_2 - \frac{\theta}{\hbar} e^{\gamma_1 t} p_1, 0) \quad (31)$$

We can not get rid of the time factor in the initial state except if $\gamma_1 = 0$ or $\theta = 0$, where we have a time independent non commutative space or an ordinary commutative space respectively. This is a consequence of the time dependance of the Bopp shift transformations (4), as the whole phase space of the second point is moving with respect to the first one.

The wave function of the system is given by the relation

$$\psi(\tau_1, \tau_2, t) = \iint G(\tau_1, \tau'_1, \tau_2, \tau'_2, t) \psi(\tau'_1, \tau'_2, 0) d\tau'_1 d\tau'_2 \quad (32)$$

The Hamiltonian (6) has the same form as the Hamiltonian in ordinary quantum mechanics. As a consequence the spectrum of $\hat{\mathcal{H}}$ is a linear combination of the following energies

$$E_j = \hbar \Omega_j \left(n_j + \frac{1}{2} \right), \quad n_j \in \mathcal{N} \quad (33)$$

The frequencies Ω_1 and Ω_2 are given by equations (21).

5. One dimensional case

In this section we will examine the case where we have one external frequency.

$$c_{43} = 0 \quad \implies \quad \mu = 0 \quad \implies \quad \frac{\lambda}{\hbar} = \frac{\hbar}{\theta} \quad (34)$$

The system is now one dimensional while the second Hamiltonian is like a potential energy. The functions f_{jk} satisfy a differential system which can be found in ref (32). The solution is as follows:

$$\begin{aligned}
 f_{11} &= -\frac{i}{2} \frac{1 - \kappa\omega_2^2\theta^2}{\cos(\Omega t) - (\gamma_1 + \gamma_2) \frac{\sin(\Omega t)}{\Omega}} \frac{\sin(\Omega t)}{\Omega} \\
 f_{21} &= -i(\gamma_1 + \gamma_2)t - i \log \left\{ \cos(\Omega t) - (\gamma_1 + \gamma_2) \frac{\sin(\Omega t)}{\Omega} \right\} \\
 f_{22} &= -\frac{i}{2} e^{-2(\gamma_1 + \gamma_2)t} \frac{\omega_1^2 - \kappa\lambda^2}{\cos(\Omega t) - (\gamma_1 + \gamma_2) \frac{\sin(\Omega t)}{\Omega}} \frac{\sin(\Omega t)}{\Omega} \\
 f_{31} &= ie^{(\gamma_1 + \gamma_2)t} \kappa\lambda \frac{1 - \kappa\omega_2^2\theta^2}{\gamma_2^2 + \Omega^2} \left\{ e^{-\gamma_2 t} - \cos(\Omega t) + \gamma_2 \frac{\sin(\Omega t)}{\Omega} \right\} \\
 f_{32} &= -ie^{-(\gamma_1 + \gamma_2)t} \kappa\lambda \left\{ \frac{\sin(\Omega t)}{\Omega} + \frac{\gamma_1}{\gamma_2^2 + \Omega^2} \left(e^{-\gamma_2 t} - \cos(\Omega t) + \gamma_2 \frac{\sin(\Omega t)}{\Omega} \right) \right\} \\
 f_{33} &= -\frac{i}{2} e^{-\gamma_2 t} \frac{k}{\gamma_2^2 + \Omega^2} \left\{ (1 - \kappa\omega_2^2\theta^2) \left(k\lambda^2 \frac{\sin(\Omega t)}{\Omega} - \omega_1^2 \frac{\sinh(\gamma_2 t)}{\gamma_2} \right) + \right. \\
 &\quad \left. \gamma_1(\gamma_1 + 2\gamma_2) \frac{\sinh(\gamma_2 t)}{\gamma_2} \right\} - \frac{i}{2} f_{31} f_{32} \\
 f_{41} &= ie^{(\gamma_1 + \gamma_2)t} \kappa\omega_2^2\theta \left\{ \frac{\sin(\Omega t)}{\Omega} - \frac{\gamma_1}{\gamma_2^2 + \Omega^2} \left(e^{\gamma_2 t} - \cos(\Omega t) + \gamma_2 \frac{\sin(\Omega t)}{\Omega} \right) \right\} \\
 f_{42} &= ie^{-(\gamma_1 + \gamma_2)t} \frac{\kappa\omega_2^2\theta(\omega_1^2 - \kappa\lambda^2)}{\gamma_2^2 + \Omega^2} \left(e^{\gamma_2 t} - \cos(\Omega t) + \gamma_2 \frac{\sin(\Omega t)}{\Omega} \right) \\
 f_{43} &= -i \frac{\kappa^2\omega_2^2}{\gamma_2^2 + \Omega^2} \left\{ \gamma_1 t - e^{-\gamma_2 t} \gamma_1 \frac{\sin(\Omega t)}{\Omega} - \right. \\
 &\quad \left. e^{-\gamma_2 t} \left(1 + \frac{2\gamma_1\gamma_2}{\gamma_2^2 + \Omega^2} \right) \left(e^{\gamma_2 t} - \cos(\Omega t) + \gamma_2 \frac{\sin(\Omega t)}{\Omega} \right) \right\} \\
 f_{44} &= \frac{i}{2} e^{\gamma_2 t} \frac{\kappa\omega_2^2}{\gamma_2^2 + \Omega^2} \left\{ (\omega_1^2 - \kappa\lambda^2) \left(\frac{\sinh(\gamma_2 t)}{\gamma_2} - \kappa\omega_2^2\theta^2 \frac{\sin(\Omega t)}{\Omega} \right) - \right. \\
 &\quad \left. \gamma_1(\gamma_1 + 2\gamma_2) \frac{\sinh(\gamma_2 t)}{\gamma_2} \right\} - \frac{i}{2} f_{41} f_{42}
 \end{aligned}$$

Where the frequency is

$$\Omega = \sqrt{\omega_1^2 + \kappa^2\omega_2^2 - \kappa(\omega_1^2\omega_2^2\theta^2 + \lambda^2) - (\gamma_1 + \gamma_2)^2} \quad (35)$$

So all the formulas involved depend on one common frequency Ω .

The same frequencies can be found also for the two dimensional case of the previous paragraph if

$$\omega_1^2 = \gamma_1(\gamma_1 + \gamma_2) \quad \text{or} \quad \gamma_2 = -\gamma_1 + \frac{\omega_1^2}{\gamma_1} \quad (36)$$

For this value of the friction parameter γ_2 and from equations (18) and (19) we find

$$\mu = 2 \quad \text{or} \quad \lambda = -\frac{1}{\theta} \quad \Rightarrow \quad \Omega_1 = \Omega \quad \Omega_2 = i\gamma_2 \quad (37)$$

It seems that for both cases, namely

$$\mu = 1 - \frac{\lambda\theta}{\hbar^2} = 0 \quad \text{and} \quad 2 - \mu = 1 + \frac{\lambda\theta}{\hbar^2} = 0 \quad (38)$$

the final propagators depend on only one frequency. In these cases, which we will study in the next section, the commutator of the second phase space is $[\hat{Q}_2, \hat{P}_2] = 0$ and $[\hat{Q}_2, \hat{P}_2] = 2i\hbar$ respectively.

In the space of the \hat{T}_j operators, we have now three commutative operators. We choose the following:

$$q_1 \rightarrow \tau_1 \quad p_2 + \frac{\lambda}{\hbar} e^{-\gamma_1 t} q_1 \rightarrow \pi_2 \quad q_2 - \frac{\theta}{\hbar} e^{\gamma_1 t} p_1 \rightarrow \tau_2 \quad (39)$$

To calculate the propagator we assume the representation

$$\hat{T}_1 = -c_{21}\partial_{\tau_1} \quad \hat{T}_2 = \tau_1 \quad \hat{T}_3 = \pi_2 \quad \hat{T}_4 = \tau_2 \quad (40)$$

To find the propagator we calculate first the propagator in the first dimension. After some algebra, we find the distribution.

$$\begin{aligned} G_1(\tau_1, \tau'_1, t) &= \hat{U}_2 \hat{U}_1 \delta(\tau_1 - \tau'_1) = \frac{e^{-\frac{1}{2}(\gamma_1 + \gamma_2)t}}{\sqrt{2i(1 - \kappa\omega_2^2\theta^2)}} \sqrt{\frac{\Omega}{\sin(\Omega t)}} \\ &\exp \left\{ \frac{i}{2} \frac{e^{-(\gamma_1 + \gamma_2)t}}{1 - \kappa\omega_2^2\theta^2} \frac{\Omega}{\sin(\Omega t)} \left[e^{-(\gamma_1 + \gamma_2)t} \left(\cos(\Omega t) + (\gamma_1 + \gamma_2) \frac{\sin(\Omega t)}{\Omega} \right) \tau_1^2 + \right. \right. \\ &\left. \left. e^{(\gamma_1 + \gamma_2)t} \left(\cos(\Omega t) - (\gamma_1 + \gamma_2) \frac{\sin(\Omega t)}{\Omega} \right) \tau_1'^2 - 2\tau_1 \tau_1' \right] \right\} \quad (41) \end{aligned}$$

The final propagator can be found by the action of the operator $\hat{U}_4 \hat{U}_3 \delta(\tau_2 - \tau'_2)$ on this distribution $G_1(\tau_1, \tau'_1, t)$. Because $c_{43} = 0$, the operator $\hat{U}_4 \hat{U}_3 \delta(\tau_2 - \tau'_2)$ does not contain any operators with respect to the second dimension. Consequently a delta function remains in the final result.

After a simple calculation we find

$$\begin{aligned} G(\tau_1, \tau'_1, \tau_2, \tau'_2, \pi_2, t) &= \hat{U}_4 \hat{U}_3 \delta(\tau_2 - \tau'_2) G_1(\tau_1, \tau'_1, t) = \\ &e^{f_{44}\tau_2^2 + f_{33}\pi_2^2 + (f_{43} - if_{32}f_{41})\pi_2\tau_2 + \tau_1(f_{32}\pi_2 + f_{42}\tau_2)} G_1(\tau_1 - if_{31}\pi_2 - if_{41}\tau_2, \tau'_1, t) \delta(\tau_2 - \tau'_2) \end{aligned} \quad (42)$$

If we find the propagator we can calculate the time evolution of a quantum system which must initially have the following form.

$$\psi(\tau_1, \tau_2, \pi_2, t)|_{t=0} = \psi_0(q_1, q_2 - \frac{\theta}{\hbar} e^{\gamma_1 t} p_1, p_2 + \frac{\lambda}{\hbar} e^{-\gamma_1 t} q_1, 0) \quad (43)$$

The initial wave function depends on time unless $\gamma_1 = 0$ or even $\gamma_1 \neq 0$ but $\theta = 0$ and $\lambda = 0$.

The wave function of the system is given by the following single integral.

$$\begin{aligned} \psi(\tau_1, \tau_2, \pi_2, t) &= \iint G(\tau_1, \tau'_1, \tau_2, \tau'_2, \pi_2, t) \psi(\tau'_1, \tau'_2, \pi_2, 0) d\tau'_1 d\tau'_2 = e^{f_{44}\tau_2^2 + f_{33}\pi_2^2} \\ &e^{(f_{43} - if_{32}f_{41})\pi_2\tau_2 + \tau_1(f_{32}\pi_2 + f_{42}\tau_2)} \int G_1(\tau_1 - if_{31}\pi_2 - if_{41}\tau_2, \tau'_1, t) \psi(\tau'_1, \tau_2, \pi_2, 0) d\tau'_1 \end{aligned} \quad (44)$$

The spectrum of the Hamiltonian $\hat{\mathcal{H}}$ is the following

$$E = \hbar\Omega \left(n + \frac{1}{2} \right), \quad n \in \mathcal{N} \quad (45)$$

which now depend on one frequency Ω of equation (35).

6. Canonical density matrix

As is well known we can find the statistical distribution function from the propagator. The relation is

$$\rho(\tau_1, \tau'_1, \tau_2, \tau'_2, b) = G(\tau_1, \tau'_1, \tau_2, \tau'_2, -i\hbar b) \quad (46)$$

where $b = 1/kT$, k is the Boltzman constant and T is the temperature. To find the partition function, we set $\tau_1 = \tau'_1$ and $\tau_2 = \tau'_2$ and then we integrate the distribution $\rho(\tau_1, \tau_2, b)$ with respect to τ_1 and τ_2 . The partition function is as follows

$$z(b) = \iint_{\mathbb{R}^2} G(\tau_1, \tau_1, \tau_2, \tau_2, -i\hbar b) d\tau_1 d\tau_2 \quad (47)$$

The problem is two dimensional. The coordinates q_1 and q_2 are operators which do not commute and its commutator must be time dependent too ($\sim \theta e^{\gamma_1 t}$). With a particular value of the parameter $\mu = 0$, the problem becomes one dimensional and so the resulting formulas depend on one frequency. We can also find one frequency for the two dimensional case. From equation (18), it is obvious that being $\mu = 0$ requires that one of the frequencies Ω_1 and Ω_2 must be equal to $i\gamma_2$. We choose $\Omega_2 = i\gamma_2$.

We will find the statistical partition function for two district cases which both depend on only one common frequency. One of these cases is the one dimensional case where $\mu = 0$ and the other is the two dimensional case where $\Omega_2 = i\gamma_2$. To simplify the results we will study the particular case where $\omega_1 = 0$ and $\gamma_1 = -\gamma_2$. For these two cases we have

$$\theta = +1/\lambda \quad \text{or} \quad \mu = 0 \quad \text{one - dimensional} \quad (48)$$

$$\theta = -1/\lambda \quad \text{or} \quad \mu = 2 \quad \text{two - dimensional} \quad (49)$$

where of course $\theta \neq 0$ and $\lambda \neq 0$.

The Hamiltonian takes now the most simple form and it is the following:

$$\hat{\mathcal{H}}(\hat{p}_1, \hat{q}_1, \hat{p}_2, \hat{q}_2) = \frac{1}{2} \hat{p}_1^2 - \kappa \left(e^{-2\gamma_2 t} \frac{1}{2} \hat{p}_2^2 + e^{2\gamma_2 t} \frac{1}{2} \omega_2^2 \hat{q}_2^2 \right) \quad (50)$$

The basic operators satisfy the commutators

$$[\hat{q}_1, \hat{q}_2] = \pm i(1/\lambda) e^{\gamma_2 t}, \quad [\hat{p}_1, \hat{p}_2] = i\lambda e^{-\gamma_2 t}, \quad [\hat{q}_j, \hat{p}_k] = i\hbar\delta_{jk} \quad (51)$$

The common frequency of the final results for both cases, is

$$\Omega = \sqrt{\omega_2^2 - \kappa\lambda^2} \quad (52)$$

which is independent of the parameter γ_2 .

For the case of one dimension ($\mu = 0$) the partition function is that of an ordinary oscillator that is

$$z_1(b) = \frac{\Omega}{\sinh(\frac{\Omega b}{2})} \int_{\mathcal{R}} \left\{ \lim_{\tau'_2 \rightarrow \tau_2} G(\tau_2, \pi_2, b) \delta(\tau_2 - \tau'_2) \right\} d\tau_2 \quad (53)$$

where $G(\tau_2, \pi_2, b)$ is a Gaussian type classical distribution function which we do not write as can be found easily from equation (42).

For the case of two dimensions ($\mu = 2$) we find the following partition function.

$$z_2(b) = \frac{\Omega^2 + \gamma_2^2}{16 \kappa \omega_2 \sin(\frac{\gamma_2 b}{2})} \sqrt{\frac{\Omega \gamma_2}{\gamma_2 \cos(\frac{\gamma_2 b}{2}) \sinh(\frac{\Omega b}{2}) - \Omega \cosh(\frac{\Omega b}{2}) \sin(\frac{\gamma_2 b}{2})}} \quad (54)$$

$$\frac{1}{\sqrt{\Omega(\gamma_2^2 - \kappa \lambda^2) \cos(\frac{\gamma_2 b}{2}) \sinh(\frac{\Omega b}{2}) - \gamma_2 \kappa^2 \omega_2^2 \cosh(\frac{\Omega b}{2}) \sin(\frac{\gamma_2 b}{2})}}$$

For high temperatures, that is for a large value of the temperature parameters, ($b \rightarrow 0$), the partition function has singularities on the points $b = 2n\pi/\gamma_2$, where n is an integer $n = \pm 1, \pm 2, \pm 3, \dots$.

For low temperatures, that is $b \rightarrow \infty$, the hyperbolic functions $\cosh(b\Omega/2)$ and $\sinh(b\Omega/2)$ are both equal to $e^{b\Omega/2}/2$. The partition function is multiplied with the factor $e^{-(1/2)b\Omega}$ and so tends to zero. The final partition function has singularities for the following values of b :

$$b = \frac{2}{\gamma_2} \left(n\pi + \arctan\left(\frac{\gamma_2}{\Omega}\right) \right) \quad b = \frac{2}{\gamma_2} \left(n\pi + \arctan\left(\frac{\Omega}{\gamma_2} \frac{\gamma_2^2 - \kappa \lambda^2}{\kappa^2 \omega_2^2}\right) \right) \quad (55)$$

In the sequel we will study the case where the parameter Ω becomes zero.

If $\kappa = -1$ the common frequency Ω can not be zero unless $\omega_2 \rightarrow \pm i\lambda$. For $\kappa = 1$ and $\lambda = \pm \omega_2$ we find $\Omega = 0$. The energy of the system now comes exclusively from the varying electromagnetic field while the energy eigenvalues of the Hamiltonian vanish.

The first partition function becomes:

$$z_1(b) = \frac{c}{\sqrt{b} \omega_2} \int_{\mathcal{R}} \left\{ \lim_{\tau'_1 \rightarrow \tau_1} \delta(\tau_1 - \tau'_1) \right\} d\tau_1 \quad (56)$$

The limit in the above equation, as well as the limit in the equation (53) means that the system can not be localized in space.

The second partition function has a well defined limit for $\Omega \rightarrow 0$. We find

$$\lim_{\Omega \rightarrow 0} z_2(b) = \frac{\gamma_2^2}{16 \kappa^2 \omega_2^2 \sin(\frac{b\gamma_2}{2})} \frac{1}{\sqrt{\sin(\frac{b\gamma_2}{2})}} \frac{1}{\sqrt{\sin(\frac{b\gamma_2}{2}) - \frac{b\gamma_2}{2} \cos(\frac{b\gamma_2}{2})}} \quad (57)$$

This last partition function has again singularities for $b = 2n\pi/\gamma_2$, where $n \in \mathcal{A}$ and in addition for some new values of the temperature $b = 1/kT$ which are the solutions of the equation $\tan(b\gamma_2/2) = b\gamma_2/2$.

With the help of the partition function $z(b)$, we can find all the thermodynamic properties of the system. The thermodynamic energy is given by the following formula:

$$\langle E \rangle = -\frac{\partial}{\partial b} \log(z(b)) \quad (58)$$

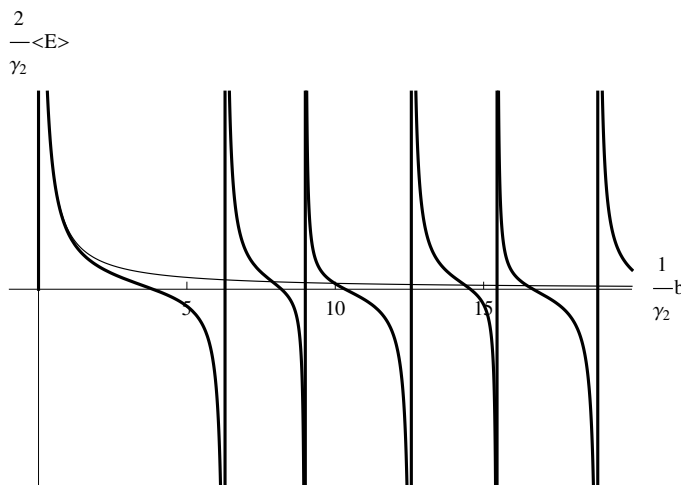

Fig. 2. The thermodynamic energy possesses many zeros and singularities.

After a simple calculation, and under certain conditions, we find the following thermodynamic energy

$$\langle E \rangle = \frac{\gamma_2}{2} \frac{b\gamma_2 + 2b\gamma_2 \cos(b\gamma_2) - 3 \sin(b\gamma_2)}{-2 + 2 \cos(b\gamma_2) + b\gamma_2 \sin(b\gamma_2)} \tag{59}$$

which possesses many zeros and singularities. These particular points disappear if the parameter γ_2 vanishes. (Figure 2). We find

$$\lim_{\gamma_2 \rightarrow 0} \langle E \rangle = 3/b \tag{60}$$

Noncommutativity is basically an internal geometric structure of the configuration space, which can not be observed per se. The last simple dynamical systems considered, have different configuration spaces and the same frequency which of course gives the same energy eigenvalues of the Hamiltonian. The thermodynamic singularities appears basically only for the two dimensional case and manifest the noncommutative phenomena. These singularities results from the varying magnetic field through the γ_2 parameter, and disappear for $\gamma_2 = 0$, that is for a constant magnetic field.

7. Conclusion

In this paper we have found the exact propagator of a two dimensional harmonic oscillator in non commutative quantum mechanics, where the ordinary non commutative parameters are time dependent. We have not investigated the problems which arise from this peculiar damping of the space, which stems from a time varying magnetic field. In this paper we are satisfied by the fact that the final results oscillate with two frequencies that are constant in time. The calculations have been made in such a way so that we can arrive at the final results, taking into consideration every special value of the parameters involved. We have first expand the time evolution operator in some kind of normal ordered form so that the propagator results easily by the action of this operator on some delta functions.

We have three damping mechanisms. The time dependent magnetic field ($\sim \lambda e^{\gamma_1 t}$), the main harmonic oscillator with varying mass ($\sim e^{-2(\gamma_1+\gamma_2)t}$) and the secondary harmonic oscillator with varying mass ($\sim (e^{2\gamma_2 t})$). The energy emitted from one of these is absorbed by the others so that the final results depend on two frequencies Ω_1 and Ω_2 which are time independent. The momenta of the system satisfy a time dependent commutator ($\sim \lambda e^{-\gamma_1 t}$) which means that we have a time dependent magnetic field and consequently an electric field present. The coordinates of the system satisfy a commutator which is also time dependent ($\sim \theta e^{\gamma_1 t}$). The coordinates space is fuzzy and fluid with parameters θ and γ_1 respectively and the momenta is also fuzzy and fluid (λ and $-\gamma_1$).

With a linear time dependent transformation, the problem reduces to that of a two dimensional harmonic oscillator on a phase space with two independent phase spaces. The new commutator relations of this new phase space become time independent. The commutator between the coordinate and the momentum of the second phase space satisfies a deformed commutator relation equal to $i(\hbar - \lambda\theta/\hbar)$. This factor has no defined limit for $\hbar \rightarrow 0$, so the problem seems to have no classical analogy.

The Hamiltonian of the system is a linear combination of two Caldirola - Kanai Hamiltonians with friction parameters which differ by the parameter γ_1 . H. Bateman uses a similar Hamiltonian and the energy emitted from one Hamiltonian was absorbed by the other one. In this paper the energy emitted from the first Hamiltonian on the point one and the time dependent magnetic field is absorbed by the other Hamiltonian on the point two. The time dependence of this second mirror Hamiltonian is the appropriate one, so that the resulting final formulas depend on two time independent frequencies.

The propagator provides the time evolution of the system. The initial wave functions depend on the two commuting variables (q_1, p_2) or (q_2, p_1) . The first point particle has a well defined position and the second well defined momentum. The system can be considered as a massive object located at two separate massive points on a fuzzy and fluid two dimensional dynamical space.

This paper is a generalization of paper (31) in the case where the magnetic field is increasing (or decreasing) exponentially at a rate equal to γ_1 . For $\gamma_1 = 0$ we found the same results while for $\gamma_1 \neq 0$ we derived some new interesting conclusions.

The parameter γ_1 destroys the time symmetry of the Hamiltonian and the product $m_1 m_2$ ($\sim e^{-2\gamma_1 t}$) is time increasing (or decreasing) exponentially. This is the main motivation of this paper. The propagator, as is well known, can also be used to find the statistical partition function and thus all the thermodynamical properties of the system. We have investigated two situations where the final results depend on only one common frequency Ω .

The first one is of course the case where the problem reduces to that of a one dimensional phase space, where $[\hat{Q}_2, \hat{P}_2] = 0$. The second is the two dimensional case where one of the frequencies becomes imaginary and equals to $\pm i\gamma_2$. We have investigated the case where $[\hat{Q}_2, \hat{P}_2] = 2i\hbar$. Because the oscillations give the energy of a harmonic oscillator the two cases have similar energies eigenvalues while they have different dimensionality. We have also found the statistical partition functions of these two systems. We have concluded that, in the two - dimensional case the partition function has many interesting zero's and singularities which are not present in the one - dimensional case. These particular points depend on the parameter γ_2 , which is responsible for the time damping of the magnetic field.

Finally we have found the partition function in the resonance where this last frequency Ω becomes zero. The thermodynamic energy of the system, possesses similar zeros and singularities that disappear when γ_2 vanish.

8. References

- [1] H. Dekker. Classical and Quantum mechanics of the damped harmonic oscillator. *Physics Reports* 80, 1. 1-110. (1981).
- [2] G. 't Hooft. Quantum gravity as a dissipative deterministic system arXiv:gr-qc/9903084v3 (1999).
- [3] A. Leggett, S. Chakravarty, A. Dorsey, M. Fisher, A. Garg, and W. Zwerger, Dynamics of the dissipative two - state system, *Rev. Mod. Phys.*, vol. 59, p.1, (1987).
- [4] A. Jannussis, G. Brodimas, A. Streklas. *Phys. Lett* 74A 6 (1979).
- [5] H. Bateman. *Phys. Rev.* 38(4), 815, (1931).
- [6] V. Aldaya, F. Cossio, J. Guerrero and F. Lopez-Ruiz. A symmetry trip from Caldirola to Bateman damped systems. arXiv:1102.0990v1 [*math – ph*] 4 Feb 2011.
- [7] M. Douglas, N. Nekrasov. Noncommutative field theory. *Rev. Mod. Phys.* Vol. 73, 977-1029 (2001).
- [8] R. Szabo Quantum field theory on noncommutative spaces, *Phys. Rep.* 378, 207-299, (2003).
- [9] N. Seiberg, L. Susskind and N. Toumbas *J. High Energy Phys.* 0006 044 (2000).
- [10] H. Snyder. *Phys. Rev.* 71, 38 and 72, 68 (1947).
- [11] A. Jannussis. Modern Physics and the Greeks. Lecture in the University "Dunarea de Jos" Galati. *Mathematica, Fizica, Mecanica Theoretica. Fascicula II, anul XVII(XXII).* (1999).
- [12] A. Connes. *Noncommutative Geometry*, Academic Press, (1994), <http://www.alainconnes.org/> Alain Connes – Official Website.
- [13] N. Seiberg, E. Witten. *String Theory and Noncommutative Geometry.* arXiv:hep-th/9908142v3 (1999).
- [14] A. Konechny. A. Schwarz. Introduction to Matrix theory and noncommutative geometry. *Patrs I and II. Phys. Rept* 360, 353, (2002).
- [15] J. Madore. Gravity on Fuzzy Space - Time. arXiv:gr-qc/9709002v2 2Sep (1997).
- [16] A. Dutra, B. Cheng. Feynman's propagator for a charged particle with time - dependent mass. *Phys. Rev. A* 3911 (1989) 5897 - 5902.
- [17] M. Liang, Y. Jiang. Time - dependent harmonic oscillator in a magnetic field and an electric field on the non - commutative plane. *Physics Letters A.* 375 1-5 (2010).
- [18] A. Hatzinikitas, I. Smyrnakis. The non commutative harmonic oscillator in more than one dimensions. *J. Math. Phys.* 43, 113, (2002).
- [19] X. Calmet, M. Wohlgenannt. Effective Field Theories on Non - Commutative Space - Time. arXiv:hep-ph/0305027v2 25 Jun 2003.
- [20] J. Gamboa, M. Loewe, F. Mendez, J. Rojas. *Mod. Phys. Lett. A* 16 2075, (2001).
- [21] M. Buric, L. Madore. A Dynamical 2 - Dimensional Fuzzy Space, arXiv:hep-th/0507064v1 (2005).
- [22] A. Eftekharzadeh, B. Hu. The Classical and Commutative Limits of noncommutative Quantum Mechanics. arXiv:hep - th/0504150v2 (2005).
- [23] M. Baldiotti, J. Gazeau, D. Gitman. Semiclassical and quantum description of motion on noncommutative plane. arXiv:0906.0388v2[*quant-ph*] 3 Jun 2009.
- [24] P. Caldirola *Nuovo Com.* 18, 393, (1941).
E. Kanai. *Prog. Theor. Phys.* 3, 440, (1948).
- [25] G. Dousmanis. Inverted Nature and Significance of Negative - Mass Landau Levels. *Phys. Rev.* Vol. 124 No. 5, 1417 - 1422. (1961).
- [26] C. Um, K. Yeon, T. George. The quantum damped harmonic oscillator. *Physics Reports* 362 63 - 192, (2002).

-
- [27] F. Delduc, Q. Duret, F. Gieres, M. Lefrancois Magnetic fields in noncommutative quantum mechanics, arXiv:0710.2239v1 (2007)
- [28] M. Liang, Y. Jiang. Time - dependent harmonic oscillator in a magnetic field and an electric field on the non - commutative plane. Physics Letters A 375 1 - 5 (2010).
- [29] M. Blasone and P. Jizba. Batemans's dual system revisited. arXiv:quant - ph/0102128 v2 (2001).
- [30] C. Cheng, P. Fung. The evolution operator technique in solving Schrödinger equation,
J. Phys. A: Math. Gen. 21 4115 - 4131 (1988).
- [31] A. Streklas. Quantum damped harmonic oscillator on non commuting plane. Physica A 385, 124 - 136, (2007).
- [32] A. Streklas. Int. J. Mod. Phys. Vol 21 No 32, 5363 - 5380, (2007).

Quantum Mechanics and Statistical Description of Results of Measurement

Lubomír Skála and Vojtěch Kapsa
*Charles University, Faculty of Mathematics and Physics
 Czech Republic*

1. Introduction

Quantum mechanics and its meaning have been discussed in a large number of publications from many different points of view (see e.g. books (Auletta, 2001; Wheeler & Zurek, 1981)). It shows that quantum mechanics is, despite its successful applications, difficult to understand. In this chapter, we discuss quantum mechanics from the point of view of mathematical statistics and show that the most important parts of the mathematical formalism of quantum mechanics can be derived from the statistical description of results of measurement. Various aspects of this approach can be found for example in (Frieden, 1998; 2004; Frieden & Soffer, 1995; Kapsa & Skála, 2009; 2011; Kapsa et al., 2010; Reginatto, 1998; 1999; Skála & Kapsa, 2005a;b; 2007a;b; 2011; Skála, Čížek & Kapsa, 2011).

One of the main differences between classical and quantum mechanics is consistent statistical description of results of measurement in quantum mechanics. In contrast to classical mechanics according to which physical measurement can be made in principle arbitrarily exact, quantum mechanics takes into consideration physical reality confirmed by experiments and describes physical measurement statistically. The most important points of the statistical description of measurement of the space coordinate x are summarized in Section 2. An important quantity appearing in this approach is the probability density $\rho(x, t)$ of obtaining the value x in measurement made at time t . For the sake of simplicity, only one spatial coordinate x is taken here.

Due to the normalization condition for the probability density corresponding to the fact that the measured system must be somewhere in space the probability density ρ must obey the continuity equation analogous to that known from classical continuum mechanics. Therefore, except for ρ , we have to take into account also the corresponding probability density current $j(x, t)$ appearing in the continuity equation. We note that the density current j is also necessary for describing the motion in space. To describe the statistical state of the system, both quantities ρ and j are necessary. It is shown in Section 3 that instead of two real quantities ρ and j , we can use also two real functions $s_1(x, t)$ and $s_2(x, t)$ given by equations $\rho = \exp(-2s_2/\hbar)$ and $j = \rho v = \rho p/m = \rho(\partial s_1/\partial x)/m$, where s_1 corresponds to the Hamilton action S in the expression $p = \partial S/\partial x$ known from the Hamilton–Jacobi theory of classical mechanics. More compact way of describing the statistical state of the system is to use the complex wave function $\psi = \exp[(is_1 - s_2)/\hbar]$ as it is done in quantum mechanics. We note that the expression for the probability density current $j = \rho(\partial s_1/\partial x)/m$ is equivalent to the expression for the probability density current known from quantum mechanics.

By analogy with the expression for the momentum $p = \partial S/\partial x$ one can make an attempt to represent the momentum by the function $p = \partial s_1/\partial x$. It is shown in Sections 4 and 5 that in case of the mean momentum $\langle p \rangle$ and the mean value $\langle xp \rangle$ this definition gives the same results as the quantum-mechanical representation of the momentum $\hat{p} = -i\hbar(\partial/\partial x)$. However, it is not true in more complicated cases when the operator representation of the momentum has to be used.

One of important quantities appearing in mathematical statistics is the Fisher information. It is shown in Section 6 that the Fisher information $I_x = (4/\hbar^2) \int_{-\infty}^{\infty} (\partial s_2/\partial x)^2 \rho dx$ fulfills the inequality $\langle (x-a)^2 \rangle I_x \geq 1$, where a is a real constant. This inequality is analogous to the uncertainty relations known from quantum mechanics and is general property of statistical theories similar to that used in quantum mechanics.

It is shown in Section 7 that the kinetic energy in quantum mechanics can be written as a sum of two terms. The first term is statistical generalization of the kinetic energy known from classical mechanics. The second part of the kinetic energy is proportional to the Fisher information I_x and does not have its counterpart in classical mechanics. Therefore, in contrast to classical mechanics, the Fisher information is an important part of the kinetic energy in quantum mechanics.

Similarly to the kinetic energy, the mean value $\langle (\Delta p)^2 \rangle$ appearing in the Heisenberg uncertainty relation $\langle (\Delta x)^2 \rangle \langle (\Delta p)^2 \rangle \geq \hbar^2/4$ can be written as a sum of two terms $\langle (\Delta p)^2 \rangle = \langle (\Delta p_1)^2 \rangle + \langle (\Delta p_2)^2 \rangle$ (Section 8). Again, the first term can be understood as statistical generalization of the expression known from classical mechanics. The second term is proportional to the Fisher information I_x . If the first term equals zero, the Heisenberg uncertainty relation is equivalent to the inequality for the Fisher information mentioned above. It shows that the inequality for the Fisher information is in quantum mechanics correctly respected.

It is shown in Section 9 that the Heisenberg uncertainty relation can be replaced by two stronger uncertainty relations for $\langle (\Delta p_1)^2 \rangle$ and $\langle (\Delta p_2)^2 \rangle$. The sum of these two uncertainty relations is equivalent to the Robertson-Schrödinger uncertainty relation (Section 10). By neglecting one term at the right-hand side of the Robertson-Schrödinger uncertainty relation the Heisenberg uncertainty relation is obtained. Therefore, two uncertainty relations discussed in Section 9 are stronger than the corresponding Heisenberg and Robertson-Schrödinger uncertainty relations. It is worth noting that the second uncertainty relation equivalent to the inequality for the Fisher information depends only on the function s_2 or the envelop of the wave function $|\psi|$. Since it does not depend on s_1 , inequality in this relation can be achieved for much larger class of the wave functions than in case of the Heisenberg and Robertson-Schrödinger uncertainty relations. It may be important in some applications as for example in the theory of the most efficient information transfer.

Two examples illustrating results of Sections 8–10, namely the gaussian wave packet for a free particle and the linear harmonic oscillator are discussed in Sections 11 and 12.

By using the normalization condition for $\rho = |\psi|^2$ it is possible to derive the equation indicating validity of the commutation relation $[x, \hat{p}] = i\hbar$ (Section 13). This commutation relation shows that it is possible to replace the momentum operator \hat{p} by the operator $\hat{p} - f$, where $f(x, t)$ is a real function. This function can describe external conditions in which the system moves and corresponds to the x -component of the vector potential.

In standard quantum mechanics, systems with the infinite lifetime are usually considered. In such a case, the normalization condition for the probability density $\int_{-\infty}^{\infty} \rho dx = 1$ is valid at all times and it does make sense to introduce the probability density in time analogous to

the probability density in space. For this reason, time is taken as a parameter in standard quantum mechanics. In Section 14, systems with a finite lifetime are considered and a decaying probability to find the system anywhere in space $\nu(t) = \int_{-\infty}^{\infty} \rho dx$ is introduced. It makes possible to define the mean lifetime and other quantities by analogy with those for the coordinate x .

Similarly to Section 13, it is then possible to get the commutation relation for the operator $i\hbar(\partial/\partial t)$ and time t and to find mathematical arguments for the existence of the scalar potentials (Section 15).

For systems with exponentially decaying wave functions, it possible to derive also the time–energy uncertainty relations (Section 16).

Equations of motion are discussed in Section 17. To derive the equation of motion, the Fisher information I_x defined for the space coordinate x is first generalized to two Fisher informations J_x and J_t in space–time in which the derivatives of the functions s_1 and s_2 with respect to x and t are taken into account. Then, the combined space–time Fisher information $J_t/c^2 \pm J_x$ is discussed. Further, we require that our theory is independent of the choice of the coordinate system in space–time and the concrete initial conditions. It yields the equation $J_t/c^2 - J_x = \text{const}$, where the signs of the space and time parts are different similarly to the signs in the metric in special relativity and $\text{const} \geq 0$. Formulating this condition in the variational form, it leads to the equation of motion mathematically equivalent to the Klein–Gordon equation. The Schrödinger equation can be viewed as the non–relativistic approximation to the Klein–Gordon equation. The Dirac equation can be obtained in a similar way. It is shown also that the equations of motion in quantum mechanics should be linear.

2. Statistical description of results of measurement

In this section, we discuss probably the most important difference between classical and quantum mechanics — statistical description of results of measurement.

We note that the measuring apparatus is not described in quantum mechanics on the microscopic level and the measured system interacts with the measuring apparatus. For this reason, results of measurement have to be described statistically. In agreement with experimental experience, we assume that results of repeated measurement of the coordinate x can be characterized by the mean values

$$\langle x \rangle = \int_{-\infty}^{\infty} x\rho(x, t) dx, \quad (1)$$

$$\langle x^2 \rangle = \int_{-\infty}^{\infty} x^2\rho(x, t) dx \quad (2)$$

and the corresponding mean square displacement

$$\langle (\Delta x)^2 \rangle = \langle x^2 \rangle - \langle x \rangle^2. \quad (3)$$

Here,

$$\Delta x = x - \langle x \rangle \quad (4)$$

an $\rho(x, t) \geq 0$ is a normalized probability density giving the probability of obtaining the value x in measurement at time t

$$\int_{-\infty}^{\infty} \rho dx = 1. \quad (5)$$

For the sake of simplicity, we assume that $\rho(x, t)$ fulfills the boundary conditions

$$\lim_{x \rightarrow \pm\infty} x^n \rho = 0, \quad n = 0, 1, 2. \quad (6)$$

We assume also that in the limit of classical mechanics

$$\rho(x, t) \rightarrow \delta(x - x_{cl}) \quad (7)$$

the mean coordinate $\langle x \rangle$ converges to the classical coordinate $x_{cl} = x_{cl}(t)$.

3. Wave function

From the point of view of our statistical description, the wave function ψ can be introduced in the following simple way.

First, we introduce a real function $s_2 = s_2(x, t)$ by the equation

$$\rho = e^{-2s_2/\hbar} \quad (8)$$

or equivalently

$$s_2 = -\frac{\hbar}{2} \ln \rho, \quad (9)$$

where \hbar denotes the reduced Planck constant, $\hbar = h/(2\pi)$. We note that the transition $\rho(x, t) \rightarrow \delta(x - x_{cl})$ can be formally performed for $\hbar \rightarrow 0_+$.

Due to normalization condition (5), the probability density ρ has to obey the continuity equation

$$\frac{\partial \rho}{\partial t} + \frac{\partial j}{\partial x} = 0, \quad (10)$$

where $j = j(x, t)$ is the probability density current in one dimension and $\partial j/\partial x$ is the divergence in one dimension.

Analogously to continuum mechanics, it is possible to express the probability density current j in terms of the "velocity" v

$$j = \rho v. \quad (11)$$

Further, by analogy with the expression $v = p/m = (\partial S/\partial x)/m$ from the Hamilton–Jacobi theory we can write

$$v = \frac{\partial s_1/\partial x}{m}, \quad (12)$$

where m is the mass of the system, a real function $s_1 = s_1(x, t)$ corresponds to the Hamilton action $S = S(x, t)$ and the function $\partial s_1/\partial x$ represents the momentum in our statistical approach. In the limit of classical mechanics when the statistical description disappears, the function s_1 has to fulfill the condition $s_1(x, t) \rightarrow S(x_{cl}, t)$ and $\partial s_1/\partial x \rightarrow \partial S/\partial x$.

It is seen that instead of two quantities ρ and j , the statistical state of the system can be described by two mutually independent real functions s_1 and s_2 or a new complex function ψ

$$\psi = e^{(is_1 - s_2)/\hbar} \quad (13)$$

depending on s_1 and s_2 (see also (Madelung, 1926)). Using this function, the probability density ρ and probability density current j given above can be rewritten in the form known from quantum mechanics

$$\rho = |\psi|^2 \quad (14)$$

and

$$j = \rho \frac{\partial s_1 / \partial x}{m} = \frac{\hbar}{2mi} \left(\psi^* \frac{\partial \psi}{\partial x} - \psi \frac{\partial \psi^*}{\partial x} \right), \quad (15)$$

where the star denotes the complex conjugate.

The function ψ called the wave function in quantum mechanics is only a different way of representing the statistical state of the system described by two real functions ρ and j or s_1 and s_2 .

We note that our expression for the wave function (13) is similar to that of Bohm (Bohm, 1952a;b). However, we do not assume the existence of hidden variables here.

4. Momentum operator

By analogy with Eq. (1) and our discussion in the preceding section, the mean momentum can be defined as (see also (Skála, Čížek & Kapsa, 2011))

$$\langle p \rangle = \int_{-\infty}^{\infty} \frac{\partial s_1}{\partial x} \rho \, dx. \quad (16)$$

It follows from conditions (6) that the integral

$$\int_{-\infty}^{\infty} \frac{\partial s_2}{\partial x} \rho \, dx = -\frac{\hbar}{2} \int_{-\infty}^{\infty} \frac{\partial \rho}{\partial x} \, dx = -\frac{\hbar}{2} \rho \Big|_{x=-\infty}^{\infty} = 0 \quad (17)$$

equals zero. Using this result it is easy to verify that Eq. (16) can be also written as

$$\langle \hat{p} \rangle = \int_{-\infty}^{\infty} \psi^* \hat{p} \psi \, dx, \quad (18)$$

where the momentum operator equals

$$\hat{p} = -i\hbar \frac{\partial}{\partial x}. \quad (19)$$

Equations (16) and (18) yield the same result and representation of the momentum by the function $\partial s_1 / \partial x$ and the operator \hat{p} is in this case equivalent.

5. Mean value of xp

In this section, we investigate the mean value of the product of the coordinate and momentum which is important in the uncertainty relations (see also (Skála, Čížek & Kapsa, 2011)).

As it is known, the mean value of the product of the coordinate and momentum is in quantum mechanics given by the expression

$$\frac{\langle x\hat{p} \rangle + \langle \hat{p}x \rangle}{2} = \frac{1}{2} \int_{-\infty}^{\infty} \psi^* \left[x \left(-i\hbar \frac{\partial}{\partial x} \right) + \left(-i\hbar \frac{\partial}{\partial x} \right) x \right] \psi \, dx. \quad (20)$$

Using Eq. (13) we get

$$\frac{\langle x\hat{p} \rangle + \langle \hat{p}x \rangle}{2} = \frac{1}{2} \int_{-\infty}^{\infty} e^{(-is_1 - s_2)/\hbar} \left[2x \left(-i\hbar \frac{\partial}{\partial x} \right) - i\hbar \right] e^{(is_1 - s_2)/\hbar} \, dx. \quad (21)$$

Now we calculate the integral

$$\int_{-\infty}^{\infty} e^{(-is_1-s_2)/\hbar} x \left(-i\hbar \frac{\partial}{\partial x} \right) e^{(is_1-s_2)/\hbar} dx = \int_{-\infty}^{\infty} x \frac{\partial s_1}{\partial x} \rho dx + i \int_{-\infty}^{\infty} x \frac{\partial s_2}{\partial x} \rho dx. \quad (22)$$

By using integration by parts in the last integral and Eqs. (5) and (6) we get

$$\int_{-\infty}^{\infty} x \frac{\partial s_2}{\partial x} \rho dx = x \frac{-\hbar}{2} \rho \Big|_{x=-\infty}^{\infty} + \frac{\hbar}{2} \int_{-\infty}^{\infty} \rho dx = \frac{\hbar}{2}. \quad (23)$$

The resulting formula

$$\frac{\langle x\hat{p} \rangle + \langle \hat{p}x \rangle}{2} = \int_{-\infty}^{\infty} x \frac{\partial s_1}{\partial x} \rho dx \quad (24)$$

agrees with the expression

$$\langle xp \rangle = \int_{-\infty}^{\infty} x \frac{\partial s_1}{\partial x} \rho dx \quad (25)$$

analogous to Eqs. (1) and (16).

Summarizing results of the last two sections we see that contribution of the function $\partial s_2/\partial x$ to the mean values $\langle \hat{p} \rangle$ and $(\langle x\hat{p} \rangle + \langle \hat{p}x \rangle)/2$ equals zero and the momentum operator can be in these cases represented either by the function $p = \partial s_1/\partial x$ or the operator $\hat{p} = -i\hbar(\partial/\partial x)$. However, as it will be seen in the following sections, it is not true in more complicated cases.

6. Fisher information

The Fisher information is a very important quantity appearing in mathematical statistics (see e.g. (Cover & Thomas, 1991; Fisher, 1925)). In our case, it can be introduced in the following simple way (see also (Frieden, 1998; 2004; Frieden & Soffer, 1995; Kapsa & Skála, 2009; 2011; Kapsa et al., 2010; Reginatto, 1998; 1999; Skála & Kapsa, 2005a;b; 2007a;b; 2011; Skála, Čížek & Kapsa, 2011)). For various applications of the Fisher information in physics and chemistry see e.g. (Chakrabarty, 2004; Hornyák & Nagy, 2007; Nagy, 2003; 2006; 2007; Nagy & Liu, 2008; Nagy & Sen, 2006; Romera & Nagy, 2008; Szabó et al., 2008).

We start with normalization condition (5) for the probability density ρ in which we perform integration by parts

$$[(x-a)\rho]_{x=-\infty}^{\infty} - \int_{-\infty}^{\infty} (x-a) \frac{\partial \rho}{\partial x} dx = 1, \quad (26)$$

where a is an arbitrary real number. Taking into account Eq. (6) we get the starting point of the following discussion

$$\int_{-\infty}^{\infty} (x-a) \frac{\partial \rho}{\partial x} dx = -1. \quad (27)$$

Now we make use of the Schwarz inequality for the inner product $(u, v) = \int_{-\infty}^{\infty} u^* v dx$ of two complex functions u and v

$$(u, u)(v, v) \geq |(u, v)|^2. \quad (28)$$

Putting

$$u = (x-a)\sqrt{\rho}, \quad (29)$$

$$v = \frac{1}{\sqrt{\rho}} \frac{\partial \rho}{\partial x} \quad (30)$$

in inequality (28) and using Eq. (27) we get

$$\int_{-\infty}^{\infty} (x-a)^2 \rho dx \int_{-\infty}^{\infty} \frac{1}{\rho} \left(\frac{\partial \rho}{\partial x} \right)^2 dx \geq 1. \quad (31)$$

Here, the second integral is the well-known quantity from mathematical statistics called the Fisher information

$$I_x = \int_{-\infty}^{\infty} \frac{1}{\rho} \left(\frac{\partial \rho}{\partial x} \right)^2 dx \geq 0. \quad (32)$$

Inequality (31) is usually written in the form (Fisher, 1925)

$$\langle (x-a)^2 \rangle I_x \geq 1. \quad (33)$$

This result is very general and does not depend on the concrete meaning of the variable x . Interpretation of the last inequality is similar to that of the uncertainty relations in quantum mechanics: For given I_x the integral $\langle (x-a)^2 \rangle$ cannot be smaller than $1/I_x$ and vice versa. The minimum of the integral $\langle (x-a)^2 \rangle$ is obtained for $a = \langle x \rangle$.

We note that inequality (33) in a more general form is known in mathematical statistics as the Rao–Cramér inequality (Cover & Thomas, 1991; Cramér, 1946a;b; Rao, 1945; 1992). Hence, any correctly formulated statistical theory has to lead to inequality (33) or an analogous one. Using Eq. (8) for the probability density the Fisher information can be written in the equivalent form

$$I_x = \frac{4}{\hbar^2} \int_{-\infty}^{\infty} \left(\frac{\partial s_2}{\partial x} \right)^2 \rho dx = \frac{4}{\hbar^2} \left\langle \left(\frac{\partial s_2}{\partial x} \right)^2 \right\rangle \quad (34)$$

which will appear in the following discussion.

7. Kinetic energy

Now we discuss the kinetic energy T in quantum mechanics

$$T = \int_{-\infty}^{\infty} \frac{|(\hat{p} - qA)\psi|^2}{2m} dx, \quad (35)$$

where q denotes the charge, m the mass and A is the vector potential in one dimension (see also (Skála, Čížek & Kapsa, 2011)).

Using Eq. (13) for the wave function and Eq. (19) for the momentum operator we get

$$(\hat{p} - qA)\psi = \left(\frac{\partial s_1}{\partial x} + i \frac{\partial s_2}{\partial x} - qA \right) e^{(is_1 - s_2)/\hbar} \quad (36)$$

and

$$|(\hat{p} - qA)\psi|^2 = \left[\left(\frac{\partial s_1}{\partial x} - qA \right)^2 + \left(\frac{\partial s_2}{\partial x} \right)^2 \right] \rho. \quad (37)$$

Therefore, the kinetic energy

$$T = \int_{-\infty}^{\infty} \frac{(\partial s_1 / \partial x - qA)^2 + (\partial s_2 / \partial x)^2}{2m} \rho dx \quad (38)$$

can be written as a sum of two terms

$$T = T_1 + T_2, \quad (39)$$

where

$$T_1 = \int_{-\infty}^{\infty} \frac{(\partial s_1 / \partial x - qA)^2}{2m} \rho \, dx \quad (40)$$

and

$$T_2 = \int_{-\infty}^{\infty} \frac{(\partial s_2 / \partial x)^2}{2m} \rho \, dx = \frac{\hbar^2 I_x}{8m}. \quad (41)$$

The first term T_1 is statistical generalization of the kinetic energy known from classical mechanics. The second part of the kinetic energy T_2 depending on $\partial s_2 / \partial x$ is proportional to the Fisher information I_x and does not have its counterpart in classical mechanics. Therefore, in contrast to classical mechanics, the Fisher information is an important part of the kinetic energy in quantum mechanics.

8. Heisenberg uncertainty relations

For the sake of simplicity, we assume that the potential A equals zero.

The Heisenberg uncertainty relation (Heisenberg, 1927) for the coordinate x and momentum p has the form

$$\langle (\Delta x)^2 \rangle \langle (\Delta p)^2 \rangle \geq \frac{\hbar^2}{4}, \quad (42)$$

where

$$\langle (\Delta x)^2 \rangle = \int_{-\infty}^{\infty} (x - \langle x \rangle)^2 |\psi|^2 \, dx \quad (43)$$

and

$$\langle (\Delta p)^2 \rangle = \int_{-\infty}^{\infty} \left| \left(-i\hbar \frac{\partial}{\partial x} - \langle \hat{p} \rangle \right) \psi \right|^2 \, dx. \quad (44)$$

Using Eqs. (13), (14) and (17) we get

$$\langle (\Delta p)^2 \rangle = \langle (\Delta p_1)^2 \rangle + \langle (\Delta p_2)^2 \rangle, \quad (45)$$

where

$$\langle (\Delta p_1)^2 \rangle = \int_{-\infty}^{\infty} \left(\frac{\partial s_1}{\partial x} - \left\langle \frac{\partial s_1}{\partial x} \right\rangle \right)^2 \rho \, dx \quad (46)$$

and

$$\langle (\Delta p_2)^2 \rangle = \int_{-\infty}^{\infty} \left(\frac{\partial s_2}{\partial x} \right)^2 \rho \, dx = \frac{\hbar^2}{4} I_x. \quad (47)$$

We see that, analogously to the kinetic energy T , the mean square deviation of the momentum $\langle (\Delta p)^2 \rangle$ can be split into two parts (see also (Kapsa & Skála, 2011; Skála & Kapsa, 2011; Skála, Čížek & Kapsa, 2011)).

The first part $\langle (\Delta p_1)^2 \rangle$ corresponds to the representation of the momentum by the function $p = \partial s_1 / \partial x$ and the first part of the kinetic energy T_1 .

The second part $\langle (\Delta p_2)^2 \rangle$ is proportional to the Fisher information I_x and corresponds to the second part of the kinetic energy T_2 . We note that for $\langle (\Delta p_1)^2 \rangle = 0$, the Heisenberg uncertainty relation (42) has the form of inequality (33) for the Fisher information with $a = \langle x \rangle$ (see also (Chakrabarty, 2004; Kapsa & Skála, 2009; 2011; Kapsa et al., 2010; Skála & Kapsa, 2005a;b; 2007a;b; 2011; Skála, Čížek & Kapsa, 2011)). Therefore, inequality (33) is in quantum mechanics correctly respected.

9. Two uncertainty relations

It is shown in this section that the Heisenberg uncertainty relation can be replaced by two uncertainty relations for $\langle(\Delta p_1)^2\rangle$ and $\langle(\Delta p_2)^2\rangle$ (see also (Kapsa & Skála, 2011; Skála & Kapsa, 2008; 2009; 2011; Skála, Čížek & Kapsa, 2011)).

According to the well-known result of mathematical statistics, the product of variances of two quantities is greater than or equal to the square of their covariance (Cramér, 1946b). In the following cases, it is equivalent to Schwarz inequality (28) with a suitable choice of the functions u and v .

First, we put

$$u = \Delta x \sqrt{\rho} \quad (48)$$

and

$$v = \left(\frac{\partial s_1}{\partial x} - \left\langle \frac{\partial s_1}{\partial x} \right\rangle \right) \sqrt{\rho}. \quad (49)$$

Then, the Schwarz inequality yields the first uncertainty relation

$$\langle(\Delta x)^2\rangle\langle(\Delta p_1)^2\rangle \geq \left[\int_{-\infty}^{\infty} \Delta x \left(\frac{\partial s_1}{\partial x} - \left\langle \frac{\partial s_1}{\partial x} \right\rangle \right) \rho \, dx \right]^2. \quad (50)$$

As it follows from section 5, the function $\partial s_1/\partial x$ in the last integral represents the momentum and this relation has the usual above mentioned meaning known from mathematical statistics. Depending on the functions s_1 and s_2 , the square of the covariance of the coordinate and momentum at the right-hand side of this relation can have arbitrary values greater than or equal to zero.

The second uncertainty relation can be obtained in an analogous way for

$$u = \Delta x \sqrt{\rho} \quad (51)$$

and

$$v = \left(\frac{\partial s_2}{\partial x} - \left\langle \frac{\partial s_2}{\partial x} \right\rangle \right) \sqrt{\rho} \quad (52)$$

with the result

$$\langle(\Delta x)^2\rangle\langle(\Delta p_2)^2\rangle \geq \left[\int_{-\infty}^{\infty} \Delta x \left(\frac{\partial s_2}{\partial x} - \left\langle \frac{\partial s_2}{\partial x} \right\rangle \right) \rho \, dx \right]^2. \quad (53)$$

It follows from Eq. (17) that the right-hand side of this relation can be simplified

$$\langle(\Delta x)^2\rangle\langle(\Delta p_2)^2\rangle \geq \left(\int_{-\infty}^{\infty} x \frac{\partial s_2}{\partial x} \rho \, dx \right)^2. \quad (54)$$

Then, Eq. (23) leads to the final form of the second uncertainty relation

$$\langle(\Delta x)^2\rangle\langle(\Delta p_2)^2\rangle \geq \frac{\hbar^2}{4}. \quad (55)$$

This uncertainty relation follows from the Schwarz inequality in a similar way as the first one, however, the covariance (u, v) is in this case constant and equals $\hbar/2 > 0$ independently of the concrete form of the functions s_2 or ρ . We note also that relation (55) is for $\langle x \rangle = a$ equivalent to inequality (33) for the Fisher information. It confirms again that inequality (33) is in quantum mechanics correctly respected.

Analogous uncertainty relations can be derived also in the multidimensional case (Skála & Kapsa, 2008; 2009) and for the mixed states described by the density matrix (Skála & Kapsa, 2009).

The sum of uncertainty relations (50) and (55) gives the relation

$$\langle(\Delta x)^2\rangle\langle(\Delta p)^2\rangle \geq \left[\int_{-\infty}^{\infty} \Delta x \left(\frac{\partial s_1}{\partial x} - \left\langle \frac{\partial s_1}{\partial x} \right\rangle \right) \rho dx \right]^2 + \frac{\hbar^2}{4}. \quad (56)$$

Heisenberg uncertainty relation (42) can be obtained from this relation by neglecting the first term on its right-hand side. Therefore, uncertainty relations (50) and (55) are stronger than the corresponding Heisenberg uncertainty relation (42).

10. Robertson–Schrödinger uncertainty relation

Relationship of uncertainty relations (50) and (55) to the Robertson–Schrödinger uncertainty relation (Peřinová et al., 1998; Robertson, 1929; 1934; Schrödinger, 1930a;b) can be clarified as follows (see also (Kapsa & Skála, 2011; Skála & Kapsa, 2011; Skála, Čížek & Kapsa, 2011)).

For two linear hermitian operators \hat{A} and \hat{B} , the Robertson–Schrödinger uncertainty relation can be written in the form

$$\langle(\Delta\hat{A})^2\rangle\langle(\Delta\hat{B})^2\rangle \geq \frac{1}{4} (\langle\{\Delta\hat{A}, \Delta\hat{B}\}\rangle^2 + |\langle[\hat{A}, \hat{B}]\rangle|^2), \quad (57)$$

where $\langle\hat{A}\rangle = \langle\psi|\hat{A}\psi\rangle$ is the mean value of the operator \hat{A} in the state described by the wave function ψ , $\Delta\hat{A} = \hat{A} - \langle\hat{A}\rangle$, $\{\hat{A}, \hat{B}\} = \hat{A}\hat{B} + \hat{B}\hat{A}$ denotes the anticommutator and $[\hat{A}, \hat{B}] = \hat{A}\hat{B} - \hat{B}\hat{A}$ the commutator of the operators \hat{A} and \hat{B} .

For the operators $\hat{x} = x$ and $\hat{p} = -i\hbar(\partial/\partial x)$ the straightforward calculation yields

$$\begin{aligned} \frac{1}{2}\langle\{\Delta x, \Delta\hat{p}\}\rangle &= \frac{1}{2} \int_{-\infty}^{\infty} \psi^* \left[\Delta x \left(-i\hbar \frac{\partial}{\partial x} - \langle\hat{p}\rangle \right) + \left(-i\hbar \frac{\partial}{\partial x} - \langle\hat{p}\rangle \right) \Delta x \right] \psi dx = \\ &= \int_{-\infty}^{\infty} \Delta x \left(\frac{\partial s_1}{\partial x} - \left\langle \frac{\partial s_1}{\partial x} \right\rangle \right) \rho dx. \end{aligned} \quad (58)$$

Further, taking into account the commutation relation $[x, \hat{p}] = i\hbar$, relation (57) leads to Eq. (56). Therefore, relations (50) and (55) are stronger than both the Heisenberg and Robertson–Schrödinger relations (42) and (56) and yield more detailed information in terms of the mean square deviations $\langle(\Delta x)^2\rangle$, $\langle(\Delta p_1)^2\rangle$ and $\langle(\Delta p_2)^2\rangle$.

For the momentum represented by the function $p = \partial s_1/\partial x$, the mean value $\langle[\Delta x, \Delta p]\rangle$ equals zero and the Heisenberg and Robertson–Schrödinger uncertainty relations (42) and (56) do not contain the term $\hbar^2/4$. It shows again that this representation of the momentum is not, except for the cases discussed in sections 4 and 5, correct.

The equality sign in Schwarz inequality (28) is obtained if the functions u and v are collinear, i.e. for $u = \text{const} v$, where *const* is a complex number. However, since the functions s_1, s_2 and ρ are real, the corresponding functions u and v are also real. Therefore, *const* must be a real number or a real function of t . It follows from the conditions $u = \text{const} v$ for the functions s_1 and s_2 that these functions have to be quadratic functions of x of the form $p(t)x^2 + q(t)x + r(t)$, where real coefficients $p(t)$, $q(t)$ and $r(t)$ can depend on time.

It is worth to notice that the condition for the equality sign in relation (55) is independent of the form of the function s_1 . Therefore, the equality sign in this relation can be achieved for much

larger class of the wave functions than in case of the Heisenberg or Robertson–Schrödinger uncertainty relations. It is interesting not only from the theoretical point of view but also from the point of view of some applications.

11. Free particle

In this section, we discuss uncertainty relations (42), (50), (55) and (56) in case of a free particle (see also (Kapsa & Skála, 2011; Skála & Kapsa, 2011; Skála, Čížek & Kapsa, 2011)).

We assume that the wave function of a free particle is at time $t = 0$ described by the gaussian wave packet

$$\psi(x, 0) = \frac{1}{\sqrt{a\sqrt{\pi}}} e^{-x^2/(2a^2) + ikx} \quad (59)$$

with the energy

$$E = \frac{\hbar^2}{4ma^2} + \frac{\hbar^2 k^2}{2m}, \quad (60)$$

where $a > 0$ and k are real constants. By solving the time Schrödinger equation we get

$$\begin{aligned} \psi(x, t) = & \frac{1}{\sqrt{a\sqrt{\pi}}} \frac{\sqrt{1 - \frac{i\hbar t}{ma^2}}}{\sqrt{1 + \left(\frac{\hbar t}{ma^2}\right)^2}} \times \\ & \times \exp \left\{ -\frac{\left(x - \frac{\hbar k}{m}t\right)^2}{2a^2 \left[1 + \left(\frac{\hbar t}{ma^2}\right)^2\right]} + i \left[\frac{kx + \frac{\hbar t x^2}{2ma^4} - \frac{\hbar k^2}{2m}t}{1 + \left(\frac{\hbar t}{ma^2}\right)^2} \right] \right\}. \end{aligned} \quad (61)$$

The corresponding functions s_1 and s_2 and their derivatives equal

$$s_1(x, t) = \hbar k \frac{x + \frac{\hbar t x^2}{2ma^4 k} - \frac{\hbar k}{2m}t}{1 + \left(\frac{\hbar t}{ma^2}\right)^2} - \hbar \arctan \frac{\hbar t}{ma^2}, \quad (62)$$

$$s_2(x, t) = \frac{\hbar}{2} \left\{ \frac{\left(x - \frac{\hbar k}{m}t\right)^2}{a^2 \left[1 + \left(\frac{\hbar t}{ma^2}\right)^2\right]} - \ln \frac{1}{a\sqrt{\pi}\sqrt{1 + \left(\frac{\hbar t}{ma^2}\right)^2}} \right\} \quad (63)$$

and

$$\frac{\partial s_1}{\partial x} = \hbar k \frac{1 + \frac{\hbar t x}{ma^4 k}}{1 + \left(\frac{\hbar t}{ma^2}\right)^2}, \quad (64)$$

$$\frac{\partial s_2}{\partial x} = \frac{\hbar \left(x - \frac{\hbar k}{m}t\right)}{a^2 \left[1 + \left(\frac{\hbar t}{ma^2}\right)^2\right]}. \quad (65)$$

As it could be anticipated, the mean momentum and the mean coordinate equal

$$\langle \hat{p} \rangle = \left\langle \frac{\partial s_1}{\partial x} \right\rangle = \hbar k \quad (66)$$

and

$$\langle x \rangle = \frac{\hbar k}{m} t. \quad (67)$$

The mean square deviations of the coordinate and momentum are given by the equations

$$\langle (\Delta x)^2 \rangle = \frac{a^2}{2} \left[1 + \left(\frac{\hbar t}{ma^2} \right)^2 \right], \quad (68)$$

$$\langle (\Delta p_1)^2 \rangle = \frac{\hbar^4 t^2}{2m^2 a^6 \left[1 + \left(\frac{\hbar t}{ma^2} \right)^2 \right]} \quad (69)$$

and

$$\langle (\Delta p_2)^2 \rangle = \frac{\hbar^2}{2a^2 \left[1 + \left(\frac{\hbar t}{ma^2} \right)^2 \right]}. \quad (70)$$

The left-hand side of relation (50) equals

$$\langle (\Delta x)^2 \rangle \langle (\Delta p_1)^2 \rangle = \frac{\hbar^4 t^2}{4m^2 a^4}. \quad (71)$$

Calculating the right-hand side of this relation we get the same result

$$\left\langle \Delta x \left(\frac{\partial s_1}{\partial x} - \left\langle \frac{\partial s_1}{\partial x} \right\rangle \right) \right\rangle^2 = \frac{\hbar^4 t^2}{4m^2 a^4}. \quad (72)$$

Therefore, uncertainty relation (50) is fulfilled with the equality sign. Calculating the left-hand side of uncertainty relation (55) we obtain

$$\langle (\Delta x)^2 \rangle \langle (\Delta p_2)^2 \rangle = \frac{\hbar^2}{4} \quad (73)$$

and see that uncertainty relation (55) is fulfilled with the equality sign, too. The corresponding Robertson–Schrödinger uncertainty relation has the form

$$\langle (\Delta x)^2 \langle (\Delta p)^2 \rangle \rangle = \frac{\hbar^4 t^2}{4m^2 a^4} + \frac{\hbar^2}{4} \quad (74)$$

and is fulfilled with the equality sign for all $t \geq 0$. The Heisenberg uncertainty relation (42) for our wave packet can be obtained if the first term on the right-hand side of the last equation is neglected.

12. Linear harmonic oscillator

The second example of application of uncertainty relations (50) and (55) is the linear harmonic oscillator in the coherent state described at time $t = 0$ by the gaussian wave packet (Skála, Kapsa & Lužová, 2011)

$$\psi(x, 0) = \left(\frac{m\omega}{\hbar\pi} \right)^{1/4} e^{-(\xi - \xi_0)^2/2}, \quad (75)$$

where

$$\zeta = \sqrt{\frac{m\omega}{\hbar}} x, \quad (76)$$

$$\zeta_0 = \sqrt{\frac{m\omega}{\hbar}} x_0 \quad (77)$$

and x_0 is the center of the packet. The corresponding energy E equals

$$E = \frac{m\omega^2 x_0^2}{2} + \frac{\hbar\omega}{2}. \quad (78)$$

By solving the time Schrödinger equation we get

$$\psi(x, t) = \left(\frac{m\omega}{\hbar\pi}\right)^{1/4} e^{-i\omega t/2} e^{i(m\omega/\hbar)[x_0^2 \cos(\omega t) - 2xx_0] \sin(\omega t)/2} e^{-(m\omega/\hbar)[x - x_0 \cos(\omega t)]^2/2}. \quad (79)$$

The corresponding functions s_1 and s_2 equal

$$s_1(x, t) = -\hbar\omega t/2 + (m\omega)[x_0^2 \cos(\omega t) - 2xx_0] \sin(\omega t)/2 \quad (80)$$

and

$$s_2(x, t) = \frac{\hbar}{4} (\ln \hbar + \ln \pi - \ln m - \ln \omega) + \frac{m\omega}{2} [x - x_0 \cos(\omega t)]^2. \quad (81)$$

The mean momentum and the mean coordinate have the same form as in classical mechanics

$$\langle \hat{p} \rangle = \left\langle \frac{\partial s_1}{\partial x} \right\rangle = -m\omega x_0 \sin(\omega t) \quad (82)$$

and

$$\langle x \rangle = x_0 \cos(\omega t). \quad (83)$$

The mean square deviations of the coordinate and momentum from their mean values are given by the equations

$$\langle (\Delta x)^2 \rangle = \frac{\hbar}{2m\omega}, \quad (84)$$

$$\langle (\Delta p_1)^2 \rangle = 0 \quad (85)$$

and

$$\langle (\Delta p_2)^2 \rangle = \frac{\hbar m\omega}{2}. \quad (86)$$

It means that uncertainty relations (50) and (55) have the form

$$0 = 0 \quad (87)$$

and

$$\langle (\Delta x)^2 \rangle \langle (\Delta p_2)^2 \rangle = \frac{\hbar^2}{4}. \quad (88)$$

It is seen that uncertainty relation (50) has in this case very simple form $0 = 0$. It follows from equation (88) that the left-hand side of relation (55) achieves for this example its minimum $\hbar^2/4$.

13. Commutation relations and vector potential

To introduce potentials, we make use of Eq. (27) with $a = 0$

$$\int_{-\infty}^{\infty} x \frac{\partial \rho}{\partial x} dx = -1. \quad (89)$$

Using Eq. (14) we get

$$\int_{-\infty}^{\infty} x \left(\frac{\partial \psi^*}{\partial x} \psi + \psi^* \frac{\partial \psi}{\partial x} \right) dx = -1. \quad (90)$$

Performing integration by parts in the first term and taking into account conditions (6) we have

$$\int_{-\infty}^{\infty} \left[\psi^* x \frac{\partial \psi}{\partial x} - \psi^* \frac{\partial}{\partial x} (x\psi) \right] dx = -1. \quad (91)$$

Multiplying this equation by $-i\hbar$ we obtain the equation

$$\int_{-\infty}^{\infty} \psi^* [x, \hat{p}] \psi dx = i\hbar \quad (92)$$

indicating validity of the commutation relation

$$[x, \hat{p}] = i\hbar \quad (93)$$

known from quantum mechanics.

Further, it is seen that Eq. (92) is valid also in case that the momentum operator \hat{p} is replaced by $\hat{p} - f$, where $f = f(x, t)$ is a real function. This function can describe external conditions in which the system moves. In physics, such functions are usually denoted as the vector potential. For example, the function f can equal qA in Eq. (35) (see also (Kapsa & Skála, 2011; Skála & Kapsa, 2005a;b; 2007a)).

14. Time

Systems investigated in standard quantum mechanics are supposed to have infinite lifetime. Therefore, normalization condition (5) is for such systems valid at all times t from the preparation of the system in a state described by ψ at time $t = t_1$ to the subsequent measurement at later time t_2 . Therefore, the probability to find the measured system anywhere in space equals one for all times $t_1 \leq t \leq t_2$. For this reason, it does not make sense to introduce the probability density in time analogous to the probability density in space and time is taken as a parameter in standard quantum mechanics.

Rather different situation is obtained if we assume that the investigated state has a finite lifetime and the probability to find the system anywhere in space

$$v(t) = \int_{-\infty}^{\infty} \rho(x, t) dx \quad (94)$$

decays in time (see also (Kapsa & Skála, 2011; Skála & Kapsa, 2005a;b; 2007a)). Normalization of v is given by the equation

$$\int_{t_1}^{\infty} v dt = 1 \quad (95)$$

expressing the fact that, after its preparation at time $t = t_1$, the investigated state decays with the probability equal to one. This generalization includes standard quantum mechanics with the infinite lifetime as a limit case.

By analogy with the coordinate x , it is then possible to define the mean lifetime τ

$$\tau = \langle t - t_1 \rangle = \int_{t_1}^{\infty} (t - t_1) \nu dt, \quad (96)$$

the mean value of the square of time

$$\langle (t - t_1)^2 \rangle = \int_{t_1}^{\infty} (t - t_1)^2 \nu dt \quad (97)$$

and the corresponding mean square deviation

$$\langle [\Delta(t - t_1)]^2 \rangle = \langle (t - t_1)^2 \rangle - \langle t - t_1 \rangle^2. \quad (98)$$

15. Scalar potential

Similarly to Eq. (26), we perform integration by parts with respect to time in Eq. (95) and get

$$(t - t_1) \nu \Big|_{t=t_1}^{\infty} - \int_{t_1}^{\infty} (t - t_1) \frac{d\nu}{dt} dt = 1. \quad (99)$$

By analogy with Eq. (6) we can assume validity of conditions

$$\lim_{t \rightarrow t_1} (t - t_1)^n \nu = 0, \quad n = 0, 1, 2 \quad (100)$$

and

$$\lim_{t \rightarrow \infty} (t - t_1)^n \nu = 0, \quad n = 0, 1, 2. \quad (101)$$

Using Eqs. (14), (94), (100) and (101) we get from Eq. (99)

$$\int_{t_1}^{\infty} (t - t_1) \left[\int_{-\infty}^{\infty} \left(\frac{\partial \psi^*}{\partial t} \psi + \psi^* \frac{\partial \psi}{\partial t} \right) dx \right] dt = -1. \quad (102)$$

Performing integration by parts in the first term and taking into account Eqs. (100) and (101) we have

$$\int_{t_1}^{\infty} \int_{-\infty}^{\infty} \left\{ \psi^* (t - t_1) \frac{\partial \psi}{\partial t} - \psi^* \frac{\partial}{\partial t} [(t - t_1) \psi] \right\} dx dt = -1. \quad (103)$$

Multiplying this equation by $-i\hbar$ we obtain the equation

$$\int_{t_1}^{\infty} \int_{-\infty}^{\infty} \psi^* \left[i\hbar \frac{\partial}{\partial t}, t - t_1 \right] \psi dx dt = i\hbar. \quad (104)$$

This result indicates that for systems with a finite lifetime the operator $i\hbar(\partial/\partial t)$ has analogous mathematical properties as the momentum operator \hat{p} .

Further, it is seen that Eq. (99) remains valid even in case when the operator $i\hbar(\partial/\partial t)$ is replaced by the operator $i\hbar(\partial/\partial t) - g$, where $g = g(x, t)$ is a real function. Analogously to the function f , the function g can describe external conditions in which the system moves. For example, the function g can equal qV , where q is the charge and V the scalar potential of the electromagnetic field (see also (Skála & Kapsa, 2005a;b; 2007a)).

16. Time–energy uncertainty relations

To derive the "time–energy" uncertainty relation, we start from the equation that is a bit more general than Eq. (99) and is analogous to Eq. (27) (see also (Skála & Kapsa, 2007a))

$$\int_{t_1}^{\infty} (t - t_1 - \langle t - t_1 \rangle) \frac{dv}{dt} dt = -1. \quad (105)$$

By using Schwarz inequality (28) for

$$u = \Delta(t - t_1) \sqrt{v}, \quad (106)$$

where

$$\Delta(t - t_1) = t - t_1 - \langle t - t_1 \rangle, \quad (107)$$

and

$$v = \frac{1}{\sqrt{v}} \frac{dv}{dt} \quad (108)$$

we get the inequality

$$\int_{t_1}^{\infty} [\Delta(t - t_1)]^2 v dt \int_{t_1}^{\infty} \frac{1}{v} \left(\frac{\partial v}{\partial t} \right)^2 dt \geq 1 \quad (109)$$

analogous to inequality (31). It is a general form of the "time–energy" uncertainty relation.

As an example, we assume now that the probability $v(t)$ to find the system in state ψ decays exponentially in time

$$v(t) = \frac{1}{\tau} e^{-(t-t_1)/\tau}, \quad (110)$$

where τ denotes the lifetime. The corresponding mean values $\langle t - t_1 \rangle$, $\langle (t - t_1)^2 \rangle$ and $\langle [\Delta(t - t_1)]^2 \rangle$ equal

$$\langle t - t_1 \rangle = \int_{t_1}^{\infty} (t - t_1) v dt = \tau, \quad (111)$$

$$\langle (t - t_1)^2 \rangle = \int_{t_1}^{\infty} (t - t_1)^2 v dt = 2\tau^2 \quad (112)$$

and

$$\langle [\Delta(t - t_1)]^2 \rangle = \int_{t_1}^{\infty} [\Delta(t - t_1)]^2 v dt = \langle (t - t_1)^2 \rangle - \langle t - t_1 \rangle^2 = \tau^2. \quad (113)$$

Further, we assume that the wave function describing the state with a finite lifetime has the following simple form

$$\psi(x, t) = \sqrt{\frac{2E_2}{\hbar}} e^{(E_1 - iE_2)(t-t_1)/(i\hbar)} \psi_0(x), \quad (114)$$

where E_1 and $E_2 > 0$ are the real and imaginary part of the energy, respectively, and $\psi_0(x)$ is the space part of the wave function. Then, using Eq. (114), we calculate the second integral in Eq. (109) and get

$$\int_{t_1}^{\infty} \frac{1}{v} \left(\frac{\partial v}{\partial t} \right)^2 dt = \frac{4E_2^2}{\hbar^2}. \quad (115)$$

The resulting time–energy uncertainty relation has the form

$$\tau^2 E_2^2 \geq \frac{\hbar^2}{4}. \quad (116)$$

This relation shows that the lifetime and imaginary part of the energy are not independent and obey the well-known time–energy uncertainty relation.

To determine the shape of the corresponding spectral line it is necessary to calculate the Fourier transform of the function (110). As a result, the Lorentz form of the spectral line is obtained.

17. Equations of motion

As mentioned above, to describe motion in space both the probability density ρ and probability density current j or the functions s_1 and s_2 have to be used. To describe time evolution, integration in the Fisher information should be obviously performed not only over the space coordinates but also over time. For these reasons and in agreement with the last three sections, we define a generalized space Fisher information in the form (see also (Kapsa & Skála, 2011; Skála & Kapsa, 2005a;b; 2007a))

$$J_x = \frac{4}{\hbar^2} \int_{t_1}^{\infty} \int_{-\infty}^{\infty} \left[\left(\frac{\partial s_1}{\partial x} \right)^2 + \left(\frac{\partial s_2}{\partial x} \right)^2 \right] \rho \, dx \, dt = 4 \int_{t_1}^{\infty} \int_{-\infty}^{\infty} \left| \frac{\partial \psi}{\partial x} \right|^2 \, dx \, dt \geq 0. \quad (117)$$

Analogously, we define a generalized time Fisher information

$$J_t = \frac{4}{\hbar^2} \int_{t_1}^{\infty} \int_{-\infty}^{\infty} \left[\left(\frac{\partial s_1}{\partial t} \right)^2 + \left(\frac{\partial s_2}{\partial t} \right)^2 \right] \rho \, dx \, dt = 4 \int_{t_1}^{\infty} \int_{-\infty}^{\infty} \left| \frac{\partial \psi}{\partial t} \right|^2 \, dx \, dt \geq 0, \quad (118)$$

where $\psi = \exp[(is_1 - s_2)/\hbar]$ and $\rho = |\psi|^2$. Both generalized Fisher informations depend on the space and time derivatives of the functions s_1 and s_2 in a similar way. Since there are no potentials in the last two equations, they correspond to a free motion.

To find equations of motion, we need an additional physical principle. To describe physical phenomena in a way independent of the choice of the concrete coordinate system and the state of the investigated system, we require that the combined generalized space–time Fisher information equals a real constant *const*

$$\frac{J_t}{c^2} \pm J_x = \text{const}. \quad (119)$$

Here, c is the speed of light and the sign in front of the generalized spatial Fisher information J_x can be either plus or minus.

First we notice that the space initial conditions for the wave function ψ at $t = 0$ can be from the mathematical point of view chosen arbitrarily and J_x can have arbitrary values greater than or equal to zero. In contrast to it, the wave function ψ at later times is given by the evolution consistent with Eq. (119). It makes possible to derive the equation of motion from this equation.

Further, to determine the sign in Eq. (119), we consider a free particle which is at rest in a given coordinate system. It follows from Eq. (38) with $A = 0$ that it is obtained for very small values of $|\partial s_1/\partial x|$ and $|\partial s_2/\partial x|$. In such a case, the Fisher information J_x is close to zero and Eq. (119) yields

$$\text{const} \geq 0. \quad (120)$$

Then, we consider a particle having a large kinetic energy T and a large Fisher information $J_x > \text{const}$. In such a case, it is impossible to obey Eq. (119) with the plus sign. Therefore, we

can conclude that the sign in Eq. (119) must be negative

$$\frac{J_t}{c^2} - J_x = \text{const.} \quad (121)$$

It is seen that this combination of the Fisher informations J_t and J_x is Lorentz invariant. The last equation can be rewritten into the form

$$\int_{t_1}^{\infty} \int_{-\infty}^{\infty} \left(\frac{1}{c^2} \left| \frac{\partial \psi}{\partial t} \right|^2 - \left| \frac{\partial \psi}{\partial x} \right|^2 - \frac{\text{const}}{4} |\psi|^2 \right) dx dt = 0. \quad (122)$$

This equation must be valid for arbitrary initial conditions at $t = t_1$, i.e., it has to be independent of ψ . Therefore, its variation must equal zero

$$\int_{t_1}^{\infty} \int_{-\infty}^{\infty} \left(\frac{1}{c^2} \frac{\partial \delta \psi^*}{\partial t} \frac{\partial \psi}{\partial t} - \frac{\partial \delta \psi^*}{\partial x} \frac{\partial \psi}{\partial x} - \frac{\text{const}}{4} \delta \psi^* \psi \right) dx dt + c.c. = 0, \quad (123)$$

where $\delta \psi$ denotes the variation of ψ . Performing integration by parts with respect to t in the first term and with respect to x in the second one and assuming that variations $\delta \psi$ and $\delta \psi^*$ equal zero at the borders of the integration region we get

$$\int_{t_1}^{\infty} \int_{-\infty}^{\infty} \delta \psi^* \left(\frac{\partial^2}{\partial x^2} - \frac{1}{c^2} \frac{\partial^2}{\partial t^2} - \frac{\text{const}}{4} \right) \psi dx dt + c.c. = 0. \quad (124)$$

This equation has to be obeyed for arbitrary values of $\delta \psi$ and $\delta \psi^*$. It leads to the equation of motion

$$\left(\frac{\partial^2}{\partial x^2} - \frac{1}{c^2} \frac{\partial^2}{\partial t^2} - \frac{\text{const}}{4} \right) \psi = 0. \quad (125)$$

We see that except for the number of space dimensions and the constant *const*, this equation has the same mathematical form as the Klein–Gordon equation known from quantum mechanics

$$\left(\Delta - \frac{1}{c^2} \frac{\partial^2}{\partial t^2} - \frac{m_0^2 c^2}{\hbar^2} \right) \psi = 0, \quad (126)$$

where m_0 is the rest mass.

We note that another derivation of the Klein–Gordon equation is given in (Frieden, 1998; 2004; Frieden & Soffer, 1995; Reginatto, 1998; 1999).

As it is known, the Schrödinger equation for a free particle

$$i\hbar \frac{\partial \varphi}{\partial t} = -\frac{\hbar^2}{2m_0} \Delta \varphi \quad (127)$$

can be obtained from the Klein–Gordon equation in the non–relativistic approximation for the function

$$\psi = e^{m_0 c^2 t / (i\hbar)} \varphi, \quad (128)$$

where φ is the wave function appearing in the Schrödinger equation.

The Dirac equation for a free particle can be also obtained in a similar way (see also (Frieden, 1998; 2004; Frieden & Soffer, 1995; Skála & Kapsa, 2005a;b; 2007a)).

Potentials can be included into the theory by the method described in sections 13 and 15.

It worth to notice that the equations of motion discussed above are linear and the superposition principle is for them valid. This property can be traced back to the expression

(32) for the Fisher informations I_x . By using the substitution $\rho = \exp(-2s_2/\hbar)$, I_x can be written in terms of the square of the function $\partial s_2/\partial x$ (see Eq. (34)). Similar approach is used in Eqs. (117) and (118) for J_x and J_t , too. Then, using Eq. (121) and performing the variations and integration by parts in Eq. (122), the squares of the functions $\partial\psi/\partial x$ and $\partial\psi/\partial t$ disappear and the second partial derivatives of ψ with respect to the coordinates and time are obtained. Therefore, the resulting equations of motion are linear.

The role of the operator $i\hbar(\partial/\partial t)$ is different from the role of the energy operator — hamiltonian. In agreement with discussion in this section, the operator $i\hbar(\partial/\partial t)$ is important for describing the time evolution of the wave function given by the equations of motion.

We note also that condition (121) of the constant value of the generalized space–time Fisher information expressed in the variational form yields in the limit of classical mechanics the Hamilton principle (Kapsa & Skála, 2009).

Finally we note that quantization known from quantum mechanics is consequence of the statistical description of results of measurement and boundary conditions applied to the wave function ψ . As it is known, only some solutions of equations of motion obey these conditions and possible states of quantum systems can be quantized.

18. Conclusion

We have shown that the basic mathematical structure of quantum mechanics can be understood as generalization of classical mechanics in which the statistical character of results of measurement is taken into account and the most important general properties of statistical theories known from mathematical statistics are correctly respected. It is not therefore surprising that quantum mechanics yields correct description of physical reality in agreement with experiments.

This work was supported by the MSMT grant No. 0021620835 of the Czech Republic.

19. References

- Auletta, G. (2001). *Foundations and Interpretation of Quantum Mechanics*, World Scientific, Singapore.
- Bohm, D. (1952a). *Phys. Rev.* 85: 166–179.
- Bohm, D. (1952b). *Phys. Rev.* 85: 180–193.
- Chakrabarty, I. (2004). *Acta Phys. Slov.* 54: 487–492.
- Cover, T. & Thomas, J. (1991). *Elements of Information Theory*, Wiley, New York.
- Cramér, H. (1946a). *Skand. Akt. Tidskr.* 29: 85–94.
- Cramér, H. (1946b). *Mathematical Methods of Statistics*, Princeton University Press, Princeton, NJ.
- Fisher, R. A. (1925). *Proc. Cambr. Phil. Soc.* 22: 700–724.
- Frieden, B. R. (1998). *Physics from Fisher Information*, Cambridge University Press, Cambridge.
- Frieden, B. R. (2004). *Science from Fisher Information: A Unification*, Cambridge University Press, Cambridge.
- Frieden, B. R. & Soffer, B. H. (1995). *Phys. Rev.* E52: 2274–2286.
- Heisenberg, W. (1927). *Z. Phys.* 43: 172–198.
- Hornýák, I. & Nagy, Á. (2007). *Chem. Phys. Lett.* 437: 123–137.
- Kapsa, V. & Skála, L. (2009). *J. Phys.* A42: 315202.
- Kapsa, V. & Skála, L. (2011). *J. Comp. Theor. Nanoscience* 8: 998–1005.
- Kapsa, V., Skála, L. & Chen, J. (2010). *physica* E42: 293–297.

- Madelung, E. (1926). *Z. Phys.* 40: 322–326.
- Nagy, Á. (2003). *J. Chem. Phys.* 119: 9401–9405.
- Nagy, Á. (2006). *Chem. Phys. Lett.* 425: 154–156.
- Nagy, Á. (2007). *Chem. Phys. Lett.* 449: 212–215.
- Nagy, Á. & Liu, S. (2008). *Phys. Lett.* A372: 1654–1656.
- Nagy, Á. & Sen, K. D. (2006). *Phys. Lett.* A360: 291–293.
- Peřinová, V., Lukš, A. & Peřina, J. (1998). *Phase in Optics*, World Scientific Publishing, Singapore.
- Rao, C. R. (1945). *Bull. Calcutta Math. Soc.* 37: 81–91.
- Rao, C. R. (1992). in S. Kotz & N. L. Johnson (eds), *Breakthroughs in Statistics*, Vol. 1, Springer, New York, reprinted paper Rao (1945).
- Reginatto, M. (1998). *Phys. Rev.* A58: 1775–1778.
- Reginatto, M. (1999). *Phys. Rev.* A60: 1730–1730.
- Robertson, H. P. (1929). *Phys. Rev.* 34: 163–164.
- Robertson, H. P. (1934). *Phys. Rev.* 46: 794–801.
- Romera, E. & Nagy, Á. (2008). *Phys. Lett.* A372: 6823–6825.
- Schrödinger, E. (1930a). *Proc. Prussian Acad. Sci. Phys.-Math. Sect.* XIX: 296–303.
- Schrödinger, E. (1930b). Translation of paper Schrödinger (1930a) to English, *Bulg. J. Phys.* 26: 193–203 (1999).
- Skála, L. & Kapsa, V. (2005a). *physica* E29: 119–128.
- Skála, L. & Kapsa, V. (2005b). *Collect. Czech. Chem. Commun.* 70: 621–637.
- Skála, L. & Kapsa, V. (2007a). *Optics and Spectroscopy* 103: 434–450.
- Skála, L. & Kapsa, V. (2007b). *Int. Rev. Phys.* 1: 302–306.
- Skála, L. & Kapsa, V. (2008). *J. Phys.* A41: 265302.
- Skála, L. & Kapsa, V. (2009). *Int. J. Quant. Chem.* 109: 1626–1630.
- Skála, L. & Kapsa, V. (2011). *Collect. Czech. Chem. Commun.* 76: 399–406.
- Skála, L., Kapsa, V. & Luřová, M. (2011). To be published.
- Skála, L., Čížek, J. & Kapsa, V. (2011). *Ann. Phys.* 326: 1174–1188.
- Szabó, J. B., Sen, K. D. & Nagy, Á. (2008). *Phys. Lett.* A372: 2428–2430.
- Wheeler, J. A. & Zurek, W. H. (1981). *Quantum Theory and Measurement*, Princeton University Press, Princeton, NJ.

Application of the Nikiforov-Uvarov Method in Quantum Mechanics

Cüneyt Berkdemir*

*The Pennsylvania State University
USA*

1. Introduction

This book chapter is addressed to readers who want to learn how to solve the time-independent Schrödinger equation (Schrödinger, 1926) in an alternative method that was introduced by A. F. Nikiforov and V. B. Uvarov (Nikiforov & Uvarov, 1988). The requirement for understanding the chapter is a knowledge of quantum mechanics in an introductory level and partial differential equations. The primary of the chapter is intended for undergraduate students in physics and chemistry however, it may be used as a reference guide for graduate students and researchers as well.

The solution of the Schrödinger equation for a physical system in quantum mechanics is of great importance, because the knowledge of wavefunction $\Psi(\mathbf{r}, t)$ and energy E contains all possible information about the physical properties of a system. This knowledge is ranging from the energy, momentum and coordinate of the particle to the wave characteristics of the particle, frequency and wavelength if we describe the quantum mechanical system by the probability amplitude $|\Psi(\mathbf{r}, t)|^2$ and its phase (Tang, 2005). $\Psi(\mathbf{r}, t)$ is supposed to describe the "state" of a particle subject to the potential energy function $V(\mathbf{r})$, where \mathbf{r} represents the spatial position of the particle. For a one-particle, one-dimensional system in cartesian coordinates, we have $\Psi(\mathbf{r}, t) = \Psi(x, t)$ and $V(\mathbf{r}) = V(x)$ or for a one-particle, three-dimensional system in spherical coordinates, we have $\Psi(\mathbf{r}, t) = \Psi(r, \theta, \phi, t)$ and $V(\mathbf{r}) = V(r, \theta, \phi)$. If we want to know how the state of the particle changes with time, we need to specify the future state, $\Psi(\mathbf{r}, t)$, of a quantum mechanical system from the knowledge of its initial state, $\Psi(\mathbf{r}, t = 0)$. To do that an equation postulated by the Austrian physicist Erwin Schrödinger (1887-1961) can help us

$$-\frac{\hbar}{i} \frac{\partial \Psi(\mathbf{r}, t)}{\partial t} = -\frac{\hbar^2}{2\mu} \nabla^2 \Psi(\mathbf{r}, t) + V(\mathbf{r})\Psi(\mathbf{r}, t), \quad (1)$$

where the constant \hbar is defined as $\hbar \equiv h/2\pi$, μ is the mass of particle and ∇^2 is an operator that can be described in any coordinate system. Eq.(1) is known as the time-dependent Schrödinger equation and it can be reduced to the time-independent one using an appropriate wavefunction $\Psi(\mathbf{r}, t) = e^{-iEt/\hbar}\Psi(\mathbf{r})$ that corresponds to states of constant E . For the states of the form $\Psi(\mathbf{r}, t) = e^{-iEt/\hbar}\Psi(\mathbf{r})$, the probability density $|\Psi(\mathbf{r}, t)|^2$ is given by $|\Psi(\mathbf{r})|^2$ and it does

*Cüneyt Berkdemir has been working as a researcher in the Pennsylvania State University, University Park, PA, USA, since 2009. His research interests include the modeling of the cluster-assembled materials and the experimental techniques of the femtosecond velocity map imaging photoelectron spectroscopy for exploring the electronic structures of gas phase clusters.

not change with time. So, we can now call the states by the "stationary state" that would be concerned mostly with states of constant energy (Levine, 2008). If we insert this wavefunction into Eq.(1), we have an equation called the time-independent Schrödinger equation

$$-\frac{\hbar^2}{2\mu}\nabla^2\Psi(\mathbf{r}) + V(\mathbf{r})\Psi(\mathbf{r}) = E\Psi(\mathbf{r}). \quad (2)$$

For simplicity, we will refer to Eq.(2) as the Schrödinger equation (SE). The solution of the SE not only depends on the potential energy function $V(\mathbf{r})$ but also depends on the coordinate system. Although many quantum mechanical system can be solved by writing the one-particle, one-dimensional SE in cartesian coordinates, we will pay our attention to the one-particle, three-dimensional SE in spherical coordinates. Therefore, in this book chapter, we will deal with any one-particle problem with a spherically symmetric potential energy function $V(r)$, where we suppose that $V(r)$ just depends on the radial variable, r , of spherical coordinates, i.e., $V(\mathbf{r}) = V(r, \theta, \phi) \equiv V(r)$. Moreover, the stationary-state wavefunction $\Psi(\mathbf{r})$ would be of the form $\Psi(r, \theta, \phi) = R(r)Y(\theta, \phi)$, in which $R(r)$ is the unknown radial wavefunction and $Y(\theta, \phi)$ are referred to as the spherical harmonics.

The solution of the SE is an interesting issue in many fields of physics and chemistry. To obtain an accurate solution of the SE is only possible for a few potentials such as harmonic oscillator potential, Coulomb potential, Kratzer potential, etc. For these potentials, one can try to solve the SE for the unknown radial wavefunction $R(r)$ and hence implicitly provide all relevant information about the behavior of a particle. The standard analytical method for solving such an equation with a variable coefficient is to expand the solution in a power series of the independent variable r and then find the recursion relationships for all the expansion coefficients (Flügge, 1971). However, the power series method has more details to reach the solution. The algebraic methods based on Lie algebra (Adams, 1994; Iachello & Levine, 1995; Iachello & Oss, 1996; Iachello & Ibrahim, 1998) are another tool to solve the SE in the framework of quantum mechanics. To constitute a suitable Lie algebra, the quantum system we are trying to find an exact solution has to be displayed a dynamical symmetry. If it is so, the ladder operators of the quantum system for some potentials are constructed by the factorization method or the supersymmetric quantum mechanics approach. The advantage of the factorization method is that the energy spectrum and the wavefunction of a quantum system are obtained algebraically if the SE is factorizable (Frank & Isacker, 1994; Infeld & Hull, 1951).

The solution of the SE is fundamental to understand the energy spectrum of a particle since the early days of quantum mechanics (Flügge, 1971). It often happens in some quantum mechanical problems that the solution of the SE with the potential $V(r)$ is not known accurately (for example, when considering the motion of a particle subject to the Morse potential together with the centrifugal term $\ell(\ell + 1)/r$ coming from the radial part of the SE in spherical coordinate). Therefore, in such cases, there is no need for an exact solution of the SE, and we must look for efficient approximate methods for its solution. From this point of view, if the SE is exactly solvable for a given potential, the wavefunction will be able to describe such a system completely, otherwise an approximated solution will be nearly describe the system. Numerical and analytical methods are complementary to find an exact or approximate solution of the SE with/without the centrifugal term $\ell(\ell + 1)/r$ for a particle in the potential $V(r)$, and each would be much poorer without the other. However, simple "hand-power methods" namely analytical methods are often more revealing because we will

see the solution stages of the problem and so it would be more meaningful than the numerical solution.

An alternative method to solve the SE by the "hand-power" is to use the Nikiforov-Uvarov (NU) method which can be described in terms of the hypergeometric-type second-order differential equations. The method based on the solutions of the general second order linear differential equation with special orthogonal functions (Szego, 1934) provides an exact solution of the SE for certain kind of potentials. The NU method is able to apply the solution of the SE in a more direct, easy and elegant way as well as the methods given in the standard textbooks.

By using the main equation given by Eq.(2), the SE can be solved by separating it in spherical coordinates for a single particle of mass μ . After separating the SE, the eigenvalue equations are solved by using the NU method and the energy levels of the discrete spectrum are obtained for a single particle. In spherical coordinates, the SE is written as follows:

$$\left\{ -\frac{\hbar^2}{2\mu} \left[\frac{1}{r^2} \frac{\partial}{\partial r} \left(r^2 \frac{\partial}{\partial r} \right) + \frac{1}{r^2 \sin\theta} \frac{\partial}{\partial \theta} \left(\sin\theta \frac{\partial}{\partial \theta} \right) + \frac{1}{r^2 \sin^2\theta} \frac{\partial^2}{\partial \phi^2} \right] \right\} \Psi(r, \theta, \phi) + V(\mathbf{r})\Psi(r, \theta, \phi) = E\Psi(r, \theta, \phi). \quad (3)$$

The energy E in Eq.(3) is real and it is either discrete for bound states ($E < 0$) or continuous for scattering states ($E > 0$). Consequently, this equation is separable for several potential such as Harmonic oscillator, Coulomb potential, Kratzer potential, Morse potential, Hulthen potential and so on. It is expected that an interesting extension of this book chapter would be to study the solution of the SE for a given potential.

This book chapter is organized as follows: in Section 2, we reviewed the NU method in detail and at the end of this section we introduced a "guide" like a "cooking list" that will show us a faster way, how to apply the NU to the solution of the SE. Section 3 is devoted to the separable variables of the SE in spherical coordinates. Application of the NU method in quantum mechanics is presented in Section 4 and so the solution of the SE for the selected potentials, i.e., Harmonic oscillator potential, Coulomb potential, Kratzer potential, Morse potential and Hulthen potential, is obtained in the same section. Finally, a few concluding remarks are given in Section 5.

2. The Nikiforov-Uvarov method

The Nikiforov-Uvarov (NU) method is based on solving the hypergeometric-type second-order differential equations by means of the special orthogonal functions (Szego, 1934). For a given potential, the Schrödinger or the Schrödinger-like equations in spherical coordinates are reduced to a generalized equation of hypergeometric-type with an appropriate coordinate transformation $r \rightarrow s$ and then they can be solved systematically to find the exact or particular solutions. The main equation which is closely associated with the method is given in the following form (Nikiforov & Uvarov, 1988)

$$\psi''(s) + \frac{\tilde{\tau}(s)}{\sigma(s)}\psi'(s) + \frac{\tilde{\sigma}(s)}{\sigma^2(s)}\psi(s) = 0, \quad (4)$$

where $\sigma(s)$ and $\tilde{\sigma}(s)$ are polynomials at most second-degree, $\tilde{\tau}(s)$ is a first-degree polynomial and $\psi(s)$ is a function of the hypergeometric-type.

By taking $\psi(s) = \phi(s)y(s)$ and choosing an appropriate function $\phi(s)$, Eq.(4) is reduced to a comprehensible form;

$$y''(s) + \left(2\frac{\phi'(s)}{\phi(s)} + \frac{\tilde{\tau}(s)}{\sigma(s)}\right)y'(s) + \left(\frac{\phi''(s)}{\phi(s)} + \frac{\phi'(s)}{\phi(s)}\frac{\tilde{\tau}(s)}{\sigma(s)} + \frac{\tilde{\sigma}(s)}{\sigma^2(s)}\right)y(s) = 0. \quad (5)$$

The coefficient of $y'(s)$ is taken in the form $\tau(s)/\sigma(s)$, where $\tau(s)$ is a polynomial of degree at most one, i.e.,

$$2\frac{\phi'(s)}{\phi(s)} + \frac{\tilde{\tau}(s)}{\sigma(s)} = \frac{\tau(s)}{\sigma(s)}, \quad (6)$$

and hence the most regular form is obtained as follows,

$$\frac{\phi'(s)}{\phi(s)} = \frac{\pi(s)}{\sigma(s)}, \quad (7)$$

where

$$\pi(s) = \frac{1}{2}[\tau(s) - \tilde{\tau}(s)]. \quad (8)$$

The most useful demonstration of Eq.(8) is

$$\tau(s) = \tilde{\tau}(s) + 2\pi(s). \quad (9)$$

The new parameter $\pi(s)$ is a polynomial of degree at most one. In addition, the term $\phi''(s)/\phi(s)$ which appears in the coefficient of $y(s)$ in Eq.(5) is arranged as follows

$$\frac{\phi''(s)}{\phi(s)} = \left(\frac{\phi'(s)}{\phi(s)}\right)' + \left(\frac{\phi'(s)}{\phi(s)}\right)^2 = \left(\frac{\pi(s)}{\sigma(s)}\right)' + \left(\frac{\pi(s)}{\sigma(s)}\right)^2. \quad (10)$$

In this case, the coefficient of $y(s)$ is transformed into a more suitable form by taking the equality given in Eq.(7);

$$\frac{\phi''(s)}{\phi(s)} + \frac{\phi'(s)}{\phi(s)}\frac{\tilde{\tau}(s)}{\sigma(s)} + \frac{\tilde{\sigma}(s)}{\sigma^2(s)} = \frac{\bar{\sigma}(s)}{\sigma^2(s)} \quad (11)$$

where

$$\bar{\sigma}(s) = \tilde{\sigma}(s) + \pi^2(s) + \pi(s)[\tilde{\tau}(s) - \sigma'(s)] + \pi'(s)\sigma(s). \quad (12)$$

Substituting the right-hand sides of Eq.(6) and Eq.(11) into Eq.(5), an equation of hypergeometric-type is obtained as follows

$$y''(s) + \frac{\tau(s)}{\sigma(s)}y'(s) + \frac{\bar{\sigma}(s)}{\sigma^2(s)}y(s) = 0. \quad (13)$$

As a consequence of the algebraic transformations mentioned above, the functional form of Eq.(4) is protected in a systematic way. If the polynomial $\bar{\sigma}(s)$ in Eq.(13) is divisible by $\sigma(s)$, i.e.,

$$\bar{\sigma}(s) = \lambda\sigma(s), \quad (14)$$

where λ is a constant, Eq.(13) is reduced to an equation of hypergeometric-type

$$\sigma(s)y''(s) + \tau(s)y'(s) + \lambda y(s) = 0, \quad (15)$$

and so its solution is given as a function of hypergeometric-type. To determine the polynomial $\pi(s)$, Eq.(12) is compared with Eq.(14) and then a quadratic equation for $\pi(s)$ is obtained as follows,

$$\pi^2(s) + \pi(s)[\tilde{\tau}(s) - \sigma'(s)] + \tilde{\sigma}(s) - k\sigma(s) = 0, \quad (16)$$

where

$$k = \lambda - \pi'(s). \quad (17)$$

The solution of this quadratic equation for $\pi(s)$ yields the following equality

$$\pi(s) = \frac{\sigma'(s) - \tilde{\tau}(s)}{2} \pm \sqrt{\left(\frac{\sigma'(s) - \tilde{\tau}(s)}{2}\right)^2 - \tilde{\sigma}(s) + k\sigma(s)}. \quad (18)$$

In order to obtain the possible solutions according to the plus and minus signs of Eq.(18), the parameter k within the square root sign must be known explicitly. To provide this requirement, the expression under the square root sign has to be the square of a polynomial, since $\pi(s)$ is a polynomial of degree at most one. In this case, an equation of the quadratic form is available for the constant k . Setting the discriminant of this quadratic equal to zero, the constant k is determined clearly. After determining k , the polynomial $\pi(s)$ is obtained from Eq.(18), and then $\tau(s)$ and λ are also obtained by using Eq.(8) and Eq.(17), respectively.

A common trend that has been followed to generalize the solutions of Eq.(15) is to show that all the derivatives of hypergeometric-type functions are also of the hypergeometric-type. For this purpose, Eq.(15) is differentiated by using the representation $v_1(s) = y'(s)$

$$\sigma(s)v_1''(s) + \tau_1(s)v_1'(s) + \mu_1v_1(s) = 0, \quad (19)$$

where $\tau_1(s) = \tau(s) + \sigma'(s)$ and $\mu_1 = \lambda + \tau'(s)$. $\tau_1(s)$ is a polynomial of degree at most one and μ_1 is a parameter that is independent of the variable s . It is clear that Eq.(19) is an equation of hypergeometric-type. By taking $v_2(s) = y''(s)$ as a new representation, the second derivative of Eq.(15) becomes

$$\sigma(s)v_2''(s) + \tau_2(s)v_2'(s) + \mu_2v_2(s) = 0, \quad (20)$$

where

$$\tau_2(s) = \tau_1(s) + \sigma'(s) = \tau(s) + 2\sigma'(s), \quad (21)$$

$$\mu_2 = \mu_1 + \tau_1'(s) = \lambda + 2\tau'(s) + \sigma''(s). \quad (22)$$

In a similar way, an equation of hypergeometric-type can be constructed as a family of particular solutions of Eq.(15) by taking $v_n(s) = y^{(n)}(s)$;

$$\sigma(s)v_n''(s) + \tau_n(s)v_n'(s) + \mu_nv_n(s) = 0, \quad (23)$$

and here the general recurrence relations for $\tau_n(s)$ and μ_n are found as follows, respectively,

$$\tau_n(s) = \tau(s) + n\sigma'(s), \quad (24)$$

$$\mu_n = \lambda + n\tau'(s) + \frac{n(n-1)}{2}\sigma''(s). \quad (25)$$

When $\mu_n = 0$, Eq.(25) becomes as follows

$$\lambda_n = -n\tau'(s) - \frac{n(n-1)}{2}\sigma''(s), \quad (n = 0, 1, 2, \dots) \quad (26)$$

and then Eq.(23) has a particular solution of the form $y(s) = y_n(s)$ which is a polynomial of degree n . To obtain an eigenvalue solution through the NU method, the relationship between λ and λ_n must be set up by means of Eq.(17) and Eq.(26). $y_n(s)$ is the hypergeometric-type function whose polynomial solutions are given by the Rodrigues relation

$$y_n(s) = \frac{B_n}{\rho(s)} \frac{d^n}{ds^n} [\sigma^n(s)\rho(s)], \quad (27)$$

where B_n is a normalization constant and the weight function $\rho(s)$ must satisfy the condition below

$$(\sigma(s)\rho(s))' = \tau(s)\rho(s). \quad (28)$$

It could be facilitative to introduce a "guide" to figure out the solution of SE in a faster way. To obtain the unknown radial wavefunction $R(r)$ and the energy eigenvalue E of the SE by means of the NU method, let us look at the following guide in the ten-steps;

- 1) reduce the differential equation that satisfies the SE into the differential equation given in Eq.(4),
- 2) compare each equations and determine the values of polynomials $\tilde{\tau}(s)$, $\sigma(s)$ and $\tilde{\sigma}(s)$. In this stage, don't forget to make some abbreviations in the original differential equation,
- 3) arrange the polynomial $\pi(s)$ given in Eq.(18) by inserting the polynomials $\tilde{\tau}(s)$, $\sigma(s)$ and $\tilde{\sigma}(s)$ we have found in the second stage and compose an equation of quadratic form under the square root sign of the $\pi(s)$,
- 4) set up the discriminant of this quadratic equal to zero, using the expression $\Delta = b^2 - 4ac = 0$ and find two roots regarding with the k , i.e., k_{\pm} ,
- 5) substitute these values of k into the $\pi(s)$ and obtain the four possible forms of $\pi(s)$. Now we have two forms of the $\pi(s)$ for k_+ and two forms for k_- . At this stage one can ask a question which of the four forms is physically valid.
- 6) try to find a negative derivative of the $\tau(s)$ given in Eq.(9) using the four forms of the $\pi(s)$ and keep this form to use it in the further stages because that would be physically valid.
- 7) recall Eq.(17) for λ and Eq.(26) for λ_n , and compare them with each other, i.e., $\lambda = \lambda_n$, and so it would be energy spectrum.
- 8) insert the values of $\sigma(s)$ and $\pi(s)$ into Eq.(7), so the result would be the functional form of $\phi(s)$,
- 9) satisfy Eq.(28) with the weight function $\rho(s)$ and obtain the hypergeometric-type function $y_n(s)$ which can be given by the Rodrigues relation in Eq.(27),
- 10) combine the $\phi(s)$ and the $y_n(s)$ to form the $\psi(s)$, and so it would be the radial wavefunction $R(r)$.

3. The Schrödinger equation in spherical coordinates

Many of the potentials that are used together with the SE are the central potentials and they are just the function of a distance between a particle and some point of origin. In spherical coordinates, a point in space is defined in terms of its distance r from the origin of the coordinate system and in terms of two angles, zenith angle θ and azimuthal angle ϕ . Therefore, we can specify a single point of three-dimensional space using these triplets (r, θ, ϕ) . In order to define a unique set of spherical coordinates for each point, we have to restrict their ranges. A common choice is $r \geq 0$, $0 \leq \theta \leq \pi$ and $0 \leq \phi \leq 2\pi$. At this section, one could ask a question about why we need to take into account the spherical coordinate to solve the SE for a particle subject to a potential function. For the realistic potentials in

physics, as an answer, the SE in spherical coordinates can be solved by using the separation of the wavefunction in terms of independent wavefunctions, i.e., $\Psi(r, \theta, \phi) = R(r)Y(\theta, \phi)$. The motion of a rotating molecule or of an electron moving around an atomic nucleus could be better described in spherical coordinates by using only a single coordinate. For example, the Coulomb potential that represents the electromagnetic interaction between an electron and a proton can be written $V(x, y, z) = -e'^2 / \sqrt{x^2 + y^2 + z^2}$ in cartesian coordinate, where $e' = e / \sqrt{4\pi\epsilon_0}$, e is the elementary electric charge and ϵ_0 is the electric permittivity of free space. It might not straightforward to solve the SE with the potential $V(x, y, z)$ because the potential has three variables which are not separable in cartesian coordinate even if the wavefunction became separable. Transformation to spherical coordinates from cartesian one would be easier to solve the SE because in this case the potential $V(x, y, z)$ would be turned to $V(r) = -e'^2 / r$ which depends only on r . For this transformation, we used the conversion $r = \sqrt{x^2 + y^2 + z^2}$. Further, the variables (x, y, z) in cartesian coordinate could be related to the variables (r, θ, ϕ) in spherical coordinates as follows;

$$x = r \sin\theta \cos\phi, \quad y = r \sin\theta \sin\phi, \quad z = r \cos\theta, \quad \theta = \cos^{-1} \left(\frac{z}{r} \right), \quad \phi = \tan^{-1} \left(\frac{y}{x} \right). \quad (29)$$

Now let us look at the separable variables in spherical coordinates. Keeping in mind the SE given in Eq.(2), we will use the relation of ∇^2 in spherical coordinates as we develop the SE in the same coordinate. So, the SE may be written as

$$\left[-\frac{\hbar^2}{2\mu} \left(\frac{1}{r^2} \frac{\partial}{\partial r} \left(r^2 \frac{\partial}{\partial r} \right) + \frac{1}{r^2 \sin\theta} \frac{\partial}{\partial \theta} \left(\sin\theta \frac{\partial}{\partial \theta} \right) + \frac{1}{r^2 \sin^2\theta} \frac{\partial^2}{\partial \phi^2} \right) + V(r) \right] \Psi(r, \theta, \phi) = E \Psi(r, \theta, \phi), \quad (30)$$

where the ∇^2 is given in spherical coordinates

$$\nabla^2 = \frac{1}{r^2} \frac{\partial}{\partial r} \left(r^2 \frac{\partial}{\partial r} \right) + \frac{1}{r^2 \sin\theta} \frac{\partial}{\partial \theta} \left(\sin\theta \frac{\partial}{\partial \theta} \right) + \frac{1}{r^2 \sin^2\theta} \frac{\partial^2}{\partial \phi^2}. \quad (31)$$

The potential we are interesting is central because it only depends on the distance r from the origin and we look for separable solution of the SE;

$$\Psi(r, \theta, \phi) = R(r)Y(\theta, \phi). \quad (32)$$

Using the assumed form of $\Psi(r, \theta, \phi)$, we may write the SE as

$$\frac{1}{R(r)} \frac{d}{dr} \left(r^2 \frac{dR(r)}{dr} \right) + \frac{2\mu}{\hbar^2} r^2 (E - V(r)) = -\frac{1}{Y(\theta, \phi)} \left[\frac{1}{\sin\theta} \frac{\partial}{\partial \theta} \left(\sin\theta \frac{\partial Y(\theta, \phi)}{\partial \theta} \right) + \frac{1}{\sin^2\theta} \frac{\partial^2 Y(\theta, \phi)}{\partial \phi^2} \right]. \quad (33)$$

The two sides of this equation depend on different variables and so they can equal each other only if they are equal to a constant L . Therefore, the following two equations have to be true simultaneously

$$\frac{1}{r^2} \frac{d}{dr} \left(r^2 \frac{dR(r)}{dr} \right) + \left[\frac{2\mu}{\hbar^2} (E - V(r)) - \frac{L}{r^2} \right] R(r) = 0, \quad (34)$$

$$\frac{1}{\sin\theta} \frac{\partial}{\partial \theta} \left(\sin\theta \frac{\partial Y(\theta, \phi)}{\partial \theta} \right) + \frac{1}{\sin^2\theta} \frac{\partial^2 Y(\theta, \phi)}{\partial \phi^2} + LY(\theta, \phi) = 0. \quad (35)$$

Now, we have two different equations and we can deal with each separately because only radial variables come into Eq.(34) and only angular variables come into Eq.(35). The solution

of the angular part given in Eq.(35) is straightforward because this part hasn't a potential or an energy term and so we can again attempt the method of separation of variables by assuming that the angular function $Y(\theta, \phi) = \Theta(\theta)\Phi(\phi)$. It should be noted that Eq.(35) is separable by inserting $Y(\theta, \phi) = \Theta(\theta)\Phi(\phi)$. $\Theta(\theta)$ and $\Phi(\phi)$ satisfy the differential equations as follows

$$\frac{1}{\sin\theta} \frac{d}{d\theta} \left(\sin\theta \frac{d\Theta(\theta)}{d\theta} \right) + \left(L - \frac{m^2}{\sin^2\theta} \right) \Theta(\theta) = 0, \quad (36)$$

$$\frac{1}{\Phi(\phi)} \frac{d^2\Phi(\phi)}{d\phi^2} = -m^2. \quad (37)$$

We definitely know that someone can solve these equations easily. There is no need for us to "reinvent the wheel" here. Therefore we will not give general solutions of these equations but we will just mention about their results that are related with the L and m , and discuss their physical significance. Based on the physically acceptable solution of the equation that depends on the variable ϕ , we can say that the separable constant m must be a positive or negative integer, i.e., $m = 0, \pm 1, \pm 2, \dots$. The constant m is also known the magnetic quantum number. If we return to the more difficult equation that depends on the variable θ , we can rewrite Eq.(36) by a change of variables $\omega = \cos\theta$. The equation with the function $\Theta(\theta)$ becomes

$$\frac{d}{d\omega} \left[(1 - \omega^2) \frac{dP(\omega)}{d\omega} \right] + \left(L - \frac{m^2}{1 - \omega^2} \right) P(\omega) = 0, \quad (38)$$

where $P(\omega)$ is the Legendre polynomial. Generally Eq.(38) has two independent solutions that became infinite for $\omega = \pm 1$. However, the wavefunctions that satisfy the boundary conditions in Eq.(38) are finite and single-valued everywhere spatially because we are studying the bound-state solutions of the SE. Nevertheless, if the constant L is of the form

$$L = \ell(\ell + 1), \quad (39)$$

where the ℓ is introduced as the orbital quantum number and the values of ℓ are equal to;

$$\ell = 0, 1, 2, 3, \dots \quad (40)$$

For these values of ℓ , one of the solutions can be finite for all values of ω . In the definition of the associate Legendre function, the magnitude of the magnetic quantum number m must be limited to values less than or equal to ℓ because the Legendre polynomials are polynomials of order ℓ ;

$$|m| = 0, 1, 2, 3, \dots \leq \ell. \quad (41)$$

On the other hand, there are $(2\ell + 1)$ allowed values for m , i.e., $-\ell \leq m \leq \ell$. Substituting $L = \ell(\ell + 1)$ into Eq.(34) shows that the radial wavefunction $R(r)$ and the eigenvalue E of the SE depend on the quantum number ℓ and satisfy the equation;

$$\frac{d^2R(r)}{dr^2} + \frac{2}{r} \frac{dR(r)}{dr} + \frac{2\mu}{\hbar^2} \left[E - V(r) - \frac{\hbar^2 \ell(\ell + 1)}{2\mu r^2} \right] R(r) = 0, \quad (42)$$

This equation can be figured an ordinary differential equation with variable coefficient and can be solved by the standard methods which have been already given in quantum mechanics text books (Flügge, 1971). However, the analytical solution of Eq.(42) would be definitely depended on the potential function $V(r)$.

4. Application of the Nikiforov-Uvarov method

4.1 Harmonic oscillator potential

The harmonic motion of a physical system means that it oscillates around a mean value at one or more characteristic frequencies. Such a system describes the motion of a bound particle in a potential well that increases quadratically with the distance from the minimum of the potential well. For example, pulling a particle subject to the end of a spring from its equilibrium position results in a contrary force pushing back toward the equilibrium position. Letting the particle go back from a position of tension results in a harmonic motion of the particle, so the particle is now a harmonic oscillator. As such, the harmonic oscillator is a model for many physical systems whose natural motions are described by the harmonic oscillator equation, such as the vibrational motion of molecules, acoustic vibration of solid, electromagnetic waves, etc.

The conventional way to deal with the harmonic oscillator problem is to obtain the energy eigenvalues and eigenfunctions of the Hamiltonian by solving the SE given in the form of Eq.(42). Now we will consider the solution of the SE for the three dimensional harmonic oscillator in spherical coordinates. Thus, in three dimensions and spherical coordinates, the SE is written as follows,

$$\frac{d^2R(r)}{dr^2} + \frac{2}{r} \frac{dR(r)}{dr} + \frac{2\mu}{\hbar^2} \left[E - \frac{1}{2}\mu\omega^2r^2 - \frac{\hbar^2\ell(\ell+1)}{2\mu r^2} \right] R(r) = 0. \quad (43)$$

where $V(r) = \frac{1}{2}\mu\omega^2r^2$ is the harmonic oscillator potential and ω is the angular frequency of the oscillator. The method used for solving such a differential equation with a variable coefficient is to expand the solution in a power series of the independent variable r and then find the recursion relationship for all the expansion coefficient. However, this method has been already applied to the solution of Eq.(43) in the past and the solution are well known after so many solution step. "Please don't panic"; because we don't need to barge into the power series solution of this equation. We will follow a pretty well organized method that is termed the NU method.

Let us apply the NU method to solve Eq.(43). To begin the solution we have to get an equivalent equation with the equation given in Eq.(4) that is a key introduction to the NU method (see (Büyükkilic et al., 1997), for a more detailed solution and explanations). It could be written an unknown radial function $R(r) = U(r)/r$ to reduce Eq.(43) into Eq.(4). The radial equation becomes

$$\frac{d^2U(r)}{dr^2} + \frac{2\mu}{\hbar^2} \left[E - \frac{1}{2}\mu\omega^2r^2 - \frac{\hbar^2\ell(\ell+1)}{2\mu r^2} \right] U(r) = 0, \quad (44)$$

where we used the derivatives

$$\frac{dR(r)}{dr} = \frac{1}{r} \frac{dU(r)}{dr} - \frac{U(r)}{r^2}, \quad r^2 \frac{dR(r)}{dr} = r \frac{dU(r)}{dr} - U(r), \quad \frac{d}{dr} \left(r^2 \frac{dR(r)}{dr} \right) = r \frac{d^2U(r)}{dr^2}. \quad (45)$$

To make this more manageable mathematically, it would be convenient to introduce dimensionless variables

$$r = \alpha\zeta, \quad \alpha = \sqrt{\frac{\hbar b a r}{\mu\omega}}, \quad \epsilon = \frac{E}{\hbar\omega}, \quad (46)$$

and to use the following derivatives

$$\frac{d}{dr} = \frac{d\zeta}{dr} \frac{d}{d\zeta}, \quad \frac{d^2}{dr^2} = \frac{1}{\alpha^2} \frac{d^2}{d\zeta^2}. \quad (47)$$

Putting these into Eq.(44), we have

$$\frac{d^2 U(\zeta)}{d\zeta^2} + \left(2\epsilon - \frac{\ell(\ell+1)}{\zeta^2} - \zeta^2 \right) U(\zeta) = 0. \quad (48)$$

By performing transformations $\zeta^2 = s$ and $U(\zeta) \rightarrow \psi(s)$ in Eq.(48), we can rewrite it in terms of s and so we can get an equation that would be comparable with Eq.(4);

$$\frac{d^2 \psi(s)}{ds^2} + \frac{1}{2s} \frac{d\psi(s)}{ds} + \frac{(-s^2 + \beta^2 s - \ell(\ell+1))}{4s^2} \psi(s) = 0, \quad (49)$$

where the variable s is in the range of $0 \leq s \leq \infty$. Furthermore we used the derivative and definition, respectively;

$$\frac{d^2 U(\zeta)}{d\zeta^2} = 4s \frac{d^2 \psi(s)}{ds^2} + 2 \frac{d\psi(s)}{ds}, \quad (50)$$

$$\beta^2 = 2\epsilon. \quad (51)$$

A comparison of Eq.(49) with Eq.(4) identifies the relevant polynomials as follows

$$\tilde{\tau} = 1, \quad \sigma(s) = 2s, \quad \tilde{\sigma} = -s^2 + \beta^2 s - \ell(\ell+1). \quad (52)$$

Inserting the polynomials given by Eq.(52) into Eq.(18) gives the polynomial $\pi(s)$:

$$\pi(s) = \frac{1}{2} \pm \sqrt{s^2 + (2k - \beta^2)s + \ell(\ell+1) + 1/4}. \quad (53)$$

The equation of quadratic form under the square root sign of Eq.(53) must be solved by setting the discriminant of this quadratic equal to zero, i.e., $\Delta = b^2 - 4ac = 0$. This discriminant gives a new quadratic equation which can be solved for the constant k to obtain the two roots;

$$\Delta = (2k - \beta^2)^2 - 4 \left(\ell(\ell+1) + \frac{1}{4} \right) = 0, \quad (54)$$

$$k^2 - k\beta^2 + \frac{\beta^4}{4} - \left(\ell(\ell+1) + \frac{1}{4} \right) = 0, \quad (55)$$

$$k_{\pm} = \frac{\beta^2 \pm \sqrt{1 + 4\ell(\ell+1)}}{2}. \quad (56)$$

When the two values of k given in Eq.(56) are substituted into Eq.(53), the four possible forms of $\pi(s)$ are obtained as

$$\pi(s) = \frac{1}{2} \pm \begin{cases} s + \frac{\sqrt{1+4\ell(\ell+1)}}{2}, & \text{for } k_+ = \frac{\beta^2 + \sqrt{1+4\ell(\ell+1)}}{2} \\ s - \frac{\sqrt{1+4\ell(\ell+1)}}{2}, & \text{for } k_- = \frac{\beta^2 - \sqrt{1+4\ell(\ell+1)}}{2}. \end{cases} \quad (57)$$

One of the four values of the polynomial $\pi(s)$ is just proper to obtain the bound-state solution because $\tau(s)$ given by Eq.(9) has a zero and a negative derivative for this value of $\pi(s)$ in the interval $(0, \infty)$ (Büyükkilic et al., 1997). Therefore, the most suitable expression of $\pi(s)$ is chosen as

$$\pi(s) = \frac{1}{2} - s + \frac{\sqrt{1 + 4\ell(\ell + 1)}}{2}, \quad (58)$$

for $k_- = (\beta^2 - \sqrt{1 + 4\ell(\ell + 1)})/2$. By using $\pi(s)$ given in Eq.(53) and remembering $\tilde{\tau} = 1$, we can obtain the expression $\tau(s) = \tilde{\tau} + 2\pi(s)$ that is introduced in Eq.(9),

$$\tau(s) = 2 + \sqrt{1 + 4\ell(\ell + 1)} - 2s, \quad (59)$$

and the derivative of this expression would be negative, i.e., $\tau'(s) = -2 < 0$, where $\tau'(s)$ represents the derivative of $\tau(s)$. The expressions $\lambda = k_- + \pi'(s)$ in Eq.(17) and $\lambda_n = -n\tau'(s) - n(n-1)\sigma''(s)/2$ in Eq.(26) are obtained as follows

$$\lambda = \frac{\beta^2 - \sqrt{1 + 4\ell(\ell + 1)}}{2} - 1, \quad (60)$$

$$\lambda_n = 2n. \quad (61)$$

When we compare these expressions, $\lambda = \lambda_n$, we can obtain the energy of the harmonic oscillator,

$$\frac{\beta^2 - \sqrt{1 + 4\ell(\ell + 1)}}{2} - 1 = 2n, \quad (62)$$

$$\frac{E}{\hbar\omega} = 2n + \ell + \frac{3}{2}, \quad (63)$$

$$E = \left(2n + \ell + \frac{3}{2}\right) \hbar\omega, \quad (64)$$

recalling $\beta^2 = 2\epsilon = 2E/\hbar\omega$. Here n is the number of nodes of the radial wave functions and if we define $n_p = 2n + \ell$ as the principal quantum number, Eq.(25) is written as

$$E_{n_p} = \left(n_p + \frac{3}{2}\right) \hbar\omega, \quad (65)$$

where $n_p = 0, 1, 2, 3, \dots$. We inserted the quantum number n_p into Eq.(26) because the harmonic oscillator's energy is usually described by the single quantum number, i.e., $n_p \equiv 2n + \ell$. n is a non-negative integer, for every even n we have $\ell = 0, 2, \dots, n - 2, n$ and for every odd n we have $\ell = 1, 3, \dots, n - 2, n$. So for every n and ℓ there are $2\ell + 1$ different quantum states, labeled by m that is an integer satisfying $-\ell \leq m \leq \ell$. Thus, the degeneracy at level n is $\sum_{\ell=0, \dots, n-2, n} (2\ell + 1) = \frac{(n+1)(n+2)}{2}$, where the sum starts from 0 or 1, according to whether n is even or odd.

Let us turn to the calculation of the wavefunction $\psi(s)$. If we remember the definition of the $\psi(s)$ that is given in Section 2, i.e., $\psi(s) = \phi(s)y_n(s)$, we can see that we have to calculate the polynomials $\phi(s)$ and $y_n(s)$. By inserting the values of $\sigma(s)$ and $\pi(s)$ given in Eq.(52) and Eq.(53) into Eq.(7), one can find the first part of the $\psi(s)$ as

$$\frac{\phi'(s)}{\phi(s)} = \frac{d\phi(s)}{d(s)} \frac{1}{\phi(s)} = \frac{\left(1 + \sqrt{1 + 4\ell(\ell + 1)}\right) / 2 - s}{2s}, \quad (66)$$

$$\frac{d\phi(s)}{d(s)} \frac{1}{\phi(s)} = \frac{\delta_1}{s} - \frac{1}{2}, \quad (67)$$

$$\int \frac{d\phi(s)}{\phi(s)} = \int \left(\frac{\delta_1}{s} - \frac{1}{2} \right) ds, \quad (68)$$

$$\log\phi(s) = \delta_1 \log s - s/2, \quad (69)$$

$$\phi(s) = s^{\delta_1} e^{-s/2}, \quad (70)$$

where $\delta_1 = \left(1 + \sqrt{1 + 4\ell(\ell + 1)}\right) / 4 = (\ell + 1)/2$. On the other hand, to find a solution for $y_n(s)$ we should first obtain the weight function $\rho(s)$ which is already inserted into Eq.(28). The weight function $\rho(s)$ given in Eq.(28) can be written in a simple form and obtained as

$$\frac{d\rho(s)}{d(s)} \frac{1}{\rho(s)} = \frac{\tau(s) - \sigma'(s)}{\sigma(s)} = \frac{2 + \sqrt{1 + 4\ell(\ell + 1)} - 2s - 2}{2s}, \quad (71)$$

$$\frac{d\rho(s)}{d(s)} \frac{1}{\rho(s)} = \frac{\sqrt{1 + 4\ell(\ell + 1)}/2}{s} - 1, \quad (72)$$

$$\int \frac{d\rho(s)}{\rho(s)} = \int \left(\frac{\delta_2}{s} - 1 \right) ds, \quad (73)$$

$$\log\rho(s) = \delta_2 \log s - s, \quad (74)$$

$$\rho(s) = s^{\delta_2} e^{-s}, \quad (75)$$

where $\delta_2 = \sqrt{1 + 4\ell(\ell + 1)}/2 = \ell + 1/2$. Substituting $\rho(s)$ into Eq.(27) allows us to obtain the polynomial $y_n(s)$ as follows

$$y_n(s) = B_n 2^n e^s s^{\delta_2} \frac{d^n}{ds^n} \left(e^{-s} s^{n+\delta_2} \right). \quad (76)$$

If we recall the Rodrigues' formula of the associated Laguerre polynomials

$$L_n^{\delta_2}(s) = \frac{1}{n!} e^s s^{\delta_2} \frac{d^n}{ds^n} \left(e^{-s} s^{n+\delta_2} \right), \quad (77)$$

Eq.(76) and Eq.(77) will yield $y_n(s) \equiv L_n^{\delta_2}(s)$, where $1/n! = B_n 2^n$. By using $\psi(s) = \phi(s)y_n(s)$, we have

$$\psi(s) = N_{n\ell} s^{\delta_1} e^{-s/2} L_n^{\delta_2}(s). \quad (78)$$

where $N_{n\ell}$ is a normalization constant. It would be useful to keep in mind that the relationship between the $\psi(s)$ and the $R(r)$ is $\psi(s) \equiv rR(r)$ with the transformations $r = \alpha\zeta$ and $\zeta^2 = s$.

4.2 Coulomb potential

As another illustration of the application of the NU method, we will take up the Coulomb potential which concerns an electron of charge $-e$ moving in the Coulomb electrostatic field of the nucleus. If nucleus is proton of positive charge e , the problem studied is that of the hydrogen atom that is a real physical system in three dimensions. So, the hydrogen atom consists of an electron moving in a spherical potential well due to the Coulomb attraction of the proton. This two-particle system (electron and proton) can be converted into a one-particle system by considering the motion of the electron relative to that of the proton in the center-of-mass frame of the two particles according to the principles of classical mechanics. In this

frame, we can replace the electron of mass by a particle of reduced mass μ moving relatively to a proton. If we have a system which consist of one electron and a nucleus of charge Ze , Z being the atomic number, we can consider a slightly more general problem, known as a hydrogen-like atom. For $Z = 1$, we have hydrogen atom; for $Z = 2$, the He^+ ion; for $Z = 3$, the Li^+ ion and so on. This means that the hydrogen-like atom would be an ionized atom. The potential energy $V(r)$ of the electron due to the Coulomb attraction of the nucleus is

$$V(r) = -\frac{Ze^2}{r} \quad (79)$$

where $e' = e/\sqrt{4\pi\epsilon_0}$. The corresponding SE for the Coulomb potential given in Eq.(79) satisfy

$$\frac{d^2R(r)}{dr^2} + \frac{2}{r} \frac{dR(r)}{dr} + \frac{2\mu}{\hbar^2} \left[E + \frac{Ze^2}{r} - \frac{\hbar^2\ell(\ell+1)}{2\mu r^2} \right] R(r) = 0. \quad (80)$$

To save time in writing, we define the constants as follows

$$a = \hbar^2/\mu e'^2 = 4\pi\epsilon_0\hbar^2/\mu e^2 \quad (81)$$

and so Eq.(80) becomes

$$\frac{d^2R(r)}{dr^2} + \frac{2}{r} \frac{dR(r)}{dr} + \frac{2\mu}{\hbar^2} \left[\frac{2E}{ae'^2} + \frac{2Z}{ar} - \frac{\ell(\ell+1)}{r^2} \right] R(r) = 0. \quad (82)$$

Now let us explicitly solve for the problem of the hydrogen-like atom using the NU method. To make our mathematics comparable with Eq.(4), we choice a function in the form of $R(r) \equiv \psi(s)$, where the transformation $r \rightarrow s$ is valid. With this choice we obtain the convenient simplification of the radial equation given in Eq.(82);

$$\frac{d^2\psi(s)}{ds^2} + \frac{2}{s} \frac{d\psi(s)}{ds} + \frac{1}{s^2} \left[-\alpha s^2 + \beta s - \gamma \right] \psi(s) = 0. \quad (83)$$

where the reduced quantities are given as

$$\alpha = -2E/ae'^2, \quad \beta = 2Z/a, \quad \gamma = \ell(\ell+1). \quad (84)$$

We restrict ourselves to bound states of negative energy E . This means that the parameter α is positive. Eq.(83) is now comparable with Eq.(4) and then the following expressions are obtained;

$$\tilde{\tau} = 2, \quad \sigma(s) = s, \quad \tilde{\sigma} = -\alpha s^2 + \beta s - \gamma. \quad (85)$$

We are able to find four possible solutions of the polynomial $\pi(s)$ as follows. To do that we insert the polynomials given by Eq.(85) into Eq.(18) and hence the polynomial $\pi(s)$ is obtained in terms of k ;

$$\pi(s) = -\frac{1}{2} \pm \frac{1}{2} \sqrt{4\alpha s^2 + (k - \beta)s + 1 + 4\gamma}. \quad (86)$$

The equation of quadratic form under the square root sign of Eq.(86) must be solved by setting the discriminant of this quadratic equal to zero, i.e., $\Delta = b^2 - 4ac = 0$. This discriminant gives a new quadratic equation which can be solved for the constant k to obtain the two roots;

$$\Delta = 16(k - \beta)^2 - 16\alpha(1 + 4\gamma) = 0, \quad (87)$$

$$k^2 - 2k\beta + \beta^2 - \alpha(1 + 4\gamma) = 0, \quad (88)$$

$$k_{\pm} = \beta \pm \sqrt{\alpha(1 + 4\gamma)}. \quad (89)$$

When the two values of k given in Eq.(89) are substituted into Eq.(86), the four possible forms of $\pi(s)$ are obtained as

$$\pi(s) = -\frac{1}{2} \pm \frac{1}{2} \begin{cases} (2\sqrt{\alpha}s + \sqrt{1 + 4\gamma}), & \text{for } k_+ = \beta + \sqrt{\alpha(1 + 4\gamma)} \\ (2\sqrt{\alpha}s - \sqrt{1 + 4\gamma}), & \text{for } k_- = \beta - \sqrt{\alpha(1 + 4\gamma)}. \end{cases} \quad (90)$$

In order to make the derivative of the polynomial $\tau(s)$ to be negative, we must select the most suitable form of the polynomial $\pi(s)$. Therefore, the most suitable expression of $\pi(s)$ is chosen as

$$\pi(s) = -\frac{1}{2} - \frac{1}{2} (2\sqrt{\alpha}s - \sqrt{1 + 4\gamma}) \quad (91)$$

for $k_- = \beta - \sqrt{\alpha(1 + 4\gamma)}$. By using $\pi(s)$ given in Eq.(91) and remembering $\tilde{\tau} = 2$, we can obtain the expression $\tau(s)$,

$$\tau(s) = 1 + \sqrt{1 + 4\gamma} - 2\sqrt{\alpha}s, \quad (92)$$

and the derivative of this expression would be negative, i.e., $\tau'(s) = -2\sqrt{\alpha} < 0$. The expressions $\lambda = k_- + \pi'(s)$ in Eq.(17) and $\lambda_n = -n\tau'(s) - n(n-1)\sigma''(s)/2$ in Eq.(26) are obtained as follows

$$\lambda = \beta - \sqrt{\alpha(1 + 4\gamma)} - \sqrt{\alpha}, \quad (93)$$

$$\lambda_n = 2n\sqrt{\alpha}, \quad (94)$$

When we compare these expressions, $\lambda = \lambda_n$, we can obtain the energy of the hydrogen-like atom,

$$\beta - \sqrt{\alpha(1 + 4\gamma)} - \sqrt{\alpha} = 2n\sqrt{\alpha}, \quad (95)$$

$$\sqrt{\alpha} (1 + 2n + \sqrt{1 + 4\gamma}) = \beta, \quad (96)$$

$$\alpha = \frac{\beta^2}{(1 + 2n + \sqrt{1 + 4\gamma})^2}, \quad (97)$$

$$-\frac{2E}{ae'^2} = \frac{(2Z/a)^2}{(1 + 2n + \sqrt{1 + 4\ell(\ell + 1)})^2}, \quad (98)$$

$$E = -\frac{Z^2\mu e'^4}{2\hbar^2(1 + n + \ell)^2}, \quad (99)$$

recalling the quantities given in Eq.(84). Here n ($n = 0, 1, 2, 3, \dots$) and ℓ are integers and we now define a new integer n_p , called the principle quantum number, by

$$n_p \equiv n + \ell + 1, \quad n_p = 1, 2, 3, \dots \quad (100)$$

The quantum number ℓ must satisfy $\ell \leq n_p - 1$ and hence it ranges from 0 to $n_p - 1$. So Eq.(99) becomes

$$E_{n_p} = -\frac{Z^2\mu e'^4}{2n_p^2\hbar^2}, \quad (101)$$

This expression represents the bound-state energy levels of the hydrogen-like atom, and the levels are discrete.

Let us now find the corresponding eigenfunctions for the radial equation. The polynomial solution of the hypergeometric-type function $y_n(s)$ depends on the determination of the weight function $\rho(s)$. Thus, using equation Eq.(7), we obtain

$$\frac{\phi'(s)}{\phi(s)} = \frac{d\phi(s)}{d(s)} \frac{1}{\phi(s)} = \frac{-\frac{1}{2} - \frac{1}{2}(2\sqrt{\alpha}s - \sqrt{1+4\gamma})}{s}, \quad (102)$$

$$\frac{d\phi(s)}{d(s)} \frac{1}{\phi(s)} = \frac{-1 + \sqrt{1+4\gamma}}{2s} - \sqrt{\alpha}, \quad (103)$$

$$\int \frac{d\phi(s)}{\phi(s)} = \int \left(\frac{-1 + \sqrt{1+4\gamma}}{2s} - \sqrt{\alpha} \right) ds, \quad (104)$$

$$\log\phi(s) = \frac{-1 + \sqrt{1+4\gamma}}{2} \log s - \sqrt{\alpha}s, \quad (105)$$

$$\phi(s) = s^{\frac{-1+\sqrt{1+4\gamma}}{2}} e^{-\sqrt{\alpha}s}, \quad (106)$$

$$\phi(s) = s^\ell e^{-\sqrt{\alpha}s}. \quad (107)$$

where $\sqrt{1+4\gamma} = \sqrt{1+4\ell(\ell+1)} = 2(\ell+1/2)$ and $\sqrt{\alpha} = Z\mu e^2/\hbar^2 n_p$. On the other hand, to find a solution for $y_n(s)$ we should first obtain the weight function $\rho(s)$ which is already inserted into Eq.(28). The weight function $\rho(s)$ given in Eq.(28) can be written in a simple form and obtained as

$$\frac{d\rho(s)}{d(s)} \frac{1}{\rho(s)} = \frac{\tau(s) - \sigma'(s)}{\sigma(s)} = \frac{1 + \sqrt{1+4\gamma} - 2\sqrt{\alpha}s - 1}{s}, \quad (108)$$

$$\frac{d\rho(s)}{d(s)} \frac{1}{\rho(s)} = \frac{\sqrt{1+4\gamma}}{s} - 2\sqrt{\alpha}, \quad (109)$$

$$\int \frac{d\rho(s)}{\rho(s)} = \int \left(\frac{\sqrt{1+4\gamma}}{s} - 2\sqrt{\alpha} \right) ds, \quad (110)$$

$$\log\rho(s) = \sqrt{1+4\gamma} \log s - 2\sqrt{\alpha}s, \quad (111)$$

$$\rho(s) = s^{\sqrt{1+4\gamma}} e^{-2\sqrt{\alpha}s}. \quad (112)$$

Substituting $\rho(s)$ into Eq.(27) allows us to obtain the polynomial $y_n(s)$ as follows

$$y_n(s) = B_n e^{2\sqrt{\alpha}s} s^{-\sqrt{1+4\gamma}} \frac{d^n}{ds^n} \left(e^{-2\sqrt{\alpha}s} s^{n+\sqrt{1+4\gamma}} \right). \quad (113)$$

It is shown from the Rodrigues' formula of the associated Laguerre polynomials

$$L_n^{2\ell+1}(2\sqrt{\alpha}s) = \frac{1}{n!} e^{2\sqrt{\alpha}s} s^{-(2\ell+1)} \frac{d^n}{ds^n} \left(e^{-2\sqrt{\alpha}s} s^{n+2\ell+1} \right) \quad (114)$$

where $1/n! = B_n$. Eq.(76) and Eq.(77) yield $y_n(s) \equiv L_n^{2\ell+1}(2\sqrt{\alpha}s)$. By using $\psi(s) = \phi(s)y_n(s)$, we have

$$\psi(s) = N_{n\ell} s^\ell e^{-\sqrt{\alpha}s} L_n^{2\ell+1}(2\sqrt{\alpha}s). \quad (115)$$

where $N_{n\ell}$ is a normalization constant and the $\psi(s)$ represents the radial wavefunction $R(r)$ through the transformation $s \rightarrow r$.

4.3 Kratzer potential

The Kratzer potential (Kratzer, 1920), which was named in B. Adolf Kratzer's honor, is one of the widely used potential models in molecular physics and chemistry. The model potential means that we can describe molecular structures and interactions by using analytical and computational methods. These methods which are used in the fields of computational and materials science have been developing for studying molecular systems ranging from small molecules (or a set of interacting molecules like clusters) to large material assemblies. However, the advancing of studies not only depends on the super-computers in modern-day science but also needs computational methods such as *ab initio* and semi-empirical methods which present complementary advantages (Herzberg, 1950).

The simplest calculations can be performed by hand, but inevitably computers are required to perform molecular modelling of any reasonably sized system. The common feature of molecular modeling techniques is the atomistic level description of the molecular systems; the lowest level of information is individual atoms (or a small group of atoms). This is in contrast to quantum chemistry (also known as electronic structure calculations) where electrons are considered explicitly. The benefit of molecular modeling is that it reduces the complexity of the system, allowing many more particles (atoms) to be considered during simulations.

Supposed that we have a model potential that is known in the form of the Kratzer potential as follows

$$V(r) = A - \frac{B}{r} + \frac{C}{r^2}, \quad (116)$$

where the parameters A , B and C are constants which are related with the Kratzer potential. If we set up the constants A and C to zero, i.e., $A = 0$ and $C = 0$, Eq.(116) can be presented in the form of Coulomb potential $V(r) = -Ze^2/r^2$, where $B = Ze^2$ and $e' = e/\sqrt{4\pi\epsilon_0}$. The solution of the Coulomb potential in the framework of the SE is already given in the previous subsection. So it could be said that the Coulomb potential is a special form of the so-called Kratzer potential. If we re-arrange the potential's parameters $A = D_e$, $B = 2D_e r_e$ and $C = D_e r_e^2$, Eq.(116) turns to the modified Kratzer potential, i.e., $V(r) = D_e ((r - r_e)/r)^2$ Berkdemir et al (2006). The dissociation energy, D_e , is the vertical distance between the dissociation limit and the minimum point of the potential curve, which is found at the equilibrium inter-atomic separation $r = r_e$. If the potential curve flattens out at the large inter-atomic distance, i.e., $r \rightarrow \infty$, it is named the dissociation limit. At this limit the potential curve converges to zero, i.e., $V(\infty) = 0$. So the dissociation energy is defined $V(r_e) - V(\infty) = -D_e$. It would be meaningful to explain the word "modified". It is not "amazing" to include the "modified" into the Kratzer potential because the modified Kratzer potential represents the Kratzer-Fues potential setting up $A = 0$, i.e., $V(r) = D_e [((r - r_e)/r)^2 - 1]$, which is shifted in amount of D_e (Fues, 1926; Pliva, 1999).

Let us try to solve the SE with the potential given by Eq.(116). Substitution of the potential $V(r) = A - B/r + C/r^2$ into Eq.(42) allows us to write down the SE;

$$\frac{d^2 R(r)}{dr^2} + \frac{2}{r} \frac{dR(r)}{dr} + \frac{2\mu}{\hbar^2} \left(E - \left[A - \frac{B}{r} + \frac{C}{r^2} \right] - \frac{\hbar^2 \ell(\ell + 1)}{2\mu r^2} \right) R(r) = 0. \quad (117)$$

In order to make further arrangements, we can rewrite the above equation as follows;

$$\frac{d^2 R(r)}{dr^2} + \frac{2}{r} \frac{dR(r)}{dr} + \frac{1}{r^2} \left[\frac{2\mu(E - A)}{\hbar^2} r^2 + \frac{2\mu B}{\hbar^2} r - \left(\frac{2\mu C}{\hbar^2} + \ell(\ell + 1) \right) \right] R(r) = 0. \quad (118)$$

For the sake of simplicity, it is convenient to introduce arbitrary parameters;

$$\begin{aligned}\alpha &= -\frac{2\mu(E-A)}{\hbar^2}, \\ \beta &= \frac{2\mu B}{\hbar^2}, \\ \gamma &= \frac{2\mu C}{\hbar^2} + \ell(\ell+1),\end{aligned}\tag{119}$$

with $\alpha > 0$ means that we are dealing with the bound state energy solutions, assuming $|E| < A$, $\beta > 0$ and $\gamma > 0$. In particular, from Eqs. (118) and (119) it follows:

$$\frac{d^2\psi(s)}{ds^2} + \frac{2}{s} \frac{d\psi(s)}{ds} + \frac{1}{s^2} (-\alpha s^2 + \beta s - \gamma) \psi(s) = 0,\tag{120}$$

which is expressed in terms of the functional $R(r) \equiv \psi(s)$ and the variable $r \rightarrow s$. In order to apply the NU method, it is necessary to compare Eq.(120) with the differential equation given in Eq.(4). A simple comparison reveals that the relevant polynomials $\tilde{\tau}(s)$, $\sigma(s)$ and $\tilde{\sigma}(s)$ are the same with Eq.(85), i.e.;

$$\begin{aligned}\tilde{\tau} &= 2, \\ \sigma(s) &= s, \\ \tilde{\sigma} &= -\alpha s^2 + \beta s - \gamma.\end{aligned}\tag{121}$$

This means that we don't need further calculations up to Eq.(97). Let us recall Eq.(97) for the bound state energy solution,

$$\alpha = \frac{\beta^2}{(1+2n+\sqrt{1+4\gamma})^2},\tag{122}$$

and keeping the values of arbitrary parameters α , β and γ given by Eq.(119) in our mind,

$$-\frac{2\mu(E-A)}{\hbar^2} = \frac{\left(\frac{2\mu B}{\hbar^2}\right)^2}{\left(1+2n+\sqrt{1+4\left(\frac{2\mu C}{\hbar^2} + \ell(\ell+1)\right)}\right)^2},\tag{123}$$

$$E = A - \frac{\hbar^2}{2\mu} \left[\left(\frac{2\mu B}{\hbar^2}\right)^2 \left(1+2n+\sqrt{1+4\left(\frac{2\mu C}{\hbar^2} + \ell(\ell+1)\right)}\right)^{-2} \right],\tag{124}$$

$$E = A - \frac{\frac{\mu B^2}{2\hbar^2}}{\left(n + \frac{1}{2} + \sqrt{\frac{2\mu C}{\hbar^2} + \left(\ell + \frac{1}{2}\right)^2}\right)^2}.\tag{125}$$

This expression indicates that we have a solution of the bound state energy spectrum for a family of the Kratzer potential. Of course, it is clear that by imposing appropriate values of the parameters A , B and C , the bound state energy spectrum for a particle in the modified Kratzer potential can be calculated immediately.

As an analogy, if we set up the parameters $A = 0$, $B = Ze'^2$ and $C = 0$, it is easy to demonstrate that Eq.(125) reduces to the bound state energy spectrum of a particle in the

Coulomb potential, i.e., $E_{n_p} = -Z^2\mu e'^4 / 2n_p^2\hbar^2$, where $n_p \equiv n + \ell + 1$. The principal quantum number n_p ranges from 1 to infinite. Thus the particle that is in the Coulomb potential will have the quantize energy levels due to the n_p . If we assume that the particle is an electron that is bound to the nucleus in a hydrogen-like atom, the electron energy would be negative relative to that of a free electron. Moreover, the electron would be confined within the Coulomb potential well owing to the presence of the positively charged nucleus. Numerically, the ground-state ($n_p = 1$) energy E_1 of the hydrogen atom ($Z = 1$) is -13.6 eV below the ionization limit $E_\infty = 0$ for the state $n_p = \infty$. In other words, the minimum amount of energy required to release the electron from a hydrogen atom is -13.6 eV that is the ground state energy of electron in the Coulomb potential. The electron can remain in this stationary ground state forever because it is stable and the electron never collapses into the nucleus. If we apply our knowledge of classical mechanics, we can see that this information is not correct. But quantum mechanically it is. Why these results are not compatible with each other? Readers are strongly encouraged to discuss the reason.

Another analogy is to be on the Kratzer potential. When we take $A = 0$, $B = 2D_e r_e$ and $C = D_e r_e^2$, Eq.(125) turns to the bound state energy spectrum of a vibrating-rotating diatomic molecule subject to the Kratzer potential as follows

$$E = - \frac{\frac{2\mu D_e^2 r_e^2}{\hbar^2}}{\left(n + \frac{1}{2} + \sqrt{\frac{2\mu D_e r_e^2}{\hbar^2} + \left(\ell + \frac{1}{2} \right)^2} \right)^2}. \quad (126)$$

Although this result came from an exact solution of the SE for the energy levels, it has not been properly used by spectroscopists because the Kratzer potential supports an infinite number of vibrational and rotational levels which is not related with the actual diatomic molecules. To see this number we can get the derivative of Eq.(126) according to n that gives the maximum vibrational quantum number n_{max} in the case of Kratzer potential (Berkdemir et al, 2006; Berkdemir & Sever, 2009);

$$\frac{dE}{dn} = \frac{\frac{4\mu D_e^2 r_e^2}{\hbar^2}}{\left(n + \frac{1}{2} + \sqrt{\frac{2\mu D_e r_e^2}{\hbar^2} + \left(\ell + \frac{1}{2} \right)^2} \right)^3} = 0, \quad (127)$$

$$n \rightarrow n_{max} = \infty. \quad (128)$$

If we take the derivative of Eq.(126) with respect to ℓ , we can reach the maximum rotational quantum number, i.e., $\ell_{max} = \infty$. As a main conclusion of these results, the Kratzer potential (or the modified Kratzer potential with $A = D_e$) does not describe the spectrum of a vibrating-rotating diatomic molecule correctly. To make sure about this knowledge the readers should be applied the selection rules to diatomic molecules by means of Eq.(126) (Fues, 1926). They will probably recognize that the spectrum that is obtained from Eq.(126) would be far away the spectroscopic results (Fernandez, 2011).

Let us now find the corresponding eigenfunctions for the Kratzer potential. According to the NU method, the wavefunction $\psi(s)$ is defined in terms of the separable functions $\phi(s)$ and $y_n(s)$. For the $\phi(s)$, we have

$$\phi(s) = s^{-\frac{1+\sqrt{1+4\gamma}}{2}} e^{-\sqrt{\alpha}s}, \quad (129)$$

where $\gamma = \frac{2\mu C}{\hbar^2} + \ell(\ell + 1)$ and $\alpha = -\frac{2\mu(E-A)}{\hbar^2}$. The polynomial solution of the hypergeometric-type function $y_n(s)$ depends on the determination of the weight function $\rho(s)$ which must satisfy the condition $(\sigma(s)\rho(s))' = \tau(s)\rho(s)$. Thus, $\rho(s)$ can be calculated by falling back on Eq.(121) and Eq.(92);

$$\rho(s) = s^{\sqrt{1+4\gamma}} e^{-2\sqrt{\alpha}s}. \quad (130)$$

Substituting Eq.(130) into the Rodrigues' formula given by Eq.(27), the hypergeometric-type function $y_n(s)$ is obtained in the following form

$$y_n(s) = B_n e^{2\sqrt{\alpha}s} s^{-\sqrt{1+4\gamma}} \frac{d^n}{ds^n} \left(e^{-2\sqrt{\alpha}s} s^{n+\sqrt{1+4\gamma}} \right). \quad (131)$$

It is shown from the Rodrigues' formula of the associated Laguerre polynomials

$$L_n^{\sqrt{1+4\gamma}}(2\sqrt{\alpha}s) = \frac{1}{n!} e^{2\sqrt{\alpha}s} s^{-\sqrt{1+4\gamma}} \frac{d^n}{ds^n} \left(e^{-2\sqrt{\alpha}s} s^{n+\sqrt{1+4\gamma}} \right) \quad (132)$$

where $1/n! = B_n$. Eq.(131) and Eq.(132) yield $y_n(s) \equiv L_n^{\sqrt{1+4\gamma}}(2\sqrt{\alpha}s)$. By using $\psi(s) = \phi(s)y_n(s)$, we have

$$\psi(s) = N_{n\ell} s^{-\frac{1+\sqrt{1+4\gamma}}{2}} e^{-\sqrt{\alpha}s} L_n^{\sqrt{1+4\gamma}}(2\sqrt{\alpha}s). \quad (133)$$

where $N_{n\ell}$ is the normalization constant.

4.4 Morse potential

The Morse potential (Morse, 1920), named after physicist Philip M. Morse, is one of the convenient models for the potential energy of a diatomic molecule. It is a better approximation for the vibrational structure of a molecule than the harmonic oscillator model because it explicitly includes the effects of bond breaking, such as the existence of unbound states. For a diatomic molecular system with reduced mass μ , the Morse potential (Morse, 1920) can be written as

$$V(r) = D_e [e^{-2a(r-r_e)} - 2e^{-a(r-r_e)}] \quad (D_e > 0, a > 0, r_e > 0), \quad (134)$$

where D_e is the dissociation energy, r_e is the equilibrium internuclear distance and a is a parameter controlling the width of the potential well. If anyone wants to modify this potential, shifting through the positive axis, it would be quite enough to insert an additional D_e into the potential. So the potential would be called the "modified" Morse potential. In an obvious manner, the word "modified" is not an "amazing" greatly. The vibrations and rotations of a two-atomic molecule can be exactly described by this potential in the case of $\ell = 0$ (Flügge, 1971). If we want to obtain the solution for $\ell \neq 0$, the centrifugal term has to be approximated to the Morse potential. In order to calculate the bound state energy spectrum and the corresponding radial wavefunction, the potential function given by Eq.(134) is inserted into the radial SE

$$\frac{d^2 R(r)}{dr^2} + \frac{2}{r} \frac{dR(r)}{dr} + \frac{2\mu}{\hbar^2} \left[E - D_e [e^{-2a(r-r_e)} - 2e^{-a(r-r_e)}] - \frac{\hbar^2 \ell(\ell+1)}{2\mu r^2} \right] R(r) = 0, \quad (135)$$

where n and ℓ can be defined the vibrational and rotational quantum numbers, respectively, and E is the appropriate energy (Berkdemir & Han, 2005; Zuniga et al., 2008). With a transformation from $R(r)$ to $U(r)/r$, Eq.(135) turns into the following one;

$$\frac{d^2 U(r)}{dr^2} + \frac{2\mu}{\hbar^2} \left[E - D_e [e^{-2a(r-r_e)} - 2e^{-a(r-r_e)}] - \frac{\hbar^2 \ell(\ell+1)}{2\mu r^2} \right] U(r) = 0. \quad (136)$$

An analytical solution of this differential equation can not be obtained without an approximation because Eq.(136) includes both exponential and radial terms. For this reason, we outline a procedure given by Pekeris (Flügge, 1971; Pekeris, 1934) to suggest an approximation to the solution of SE given in Eq.(136).

The approximation is based on the expansion of the centrifugal term in a series of exponential depending on the internuclear distance, keeping terms up to second order. In this way, the centrifugal term can be rearranged by keeping the parameters in the Morse potential. However, by construction, this approximation is valid only for the low vibrational energy states. Therefore, we can take into account the rotational term in the following way, using the Pekeris approximation. We first simplify the centrifugal part of Eq.(136) by changing the coordinates $x = (r - r_e)/r_e$ around $x = 0$. Hence, it may be expanded into a series of powers as

$$V_{rot}(x) = \frac{\eta}{(1+x)^2} = \eta(1 - 2x + 3x^2 - 4x^3 + \dots), \quad (137)$$

with

$$\eta = \frac{\hbar^2 \ell(\ell+1)}{2\mu r_e^2}, \quad (138)$$

the first few terms should be quite sufficient. Instead, we now replace the rotational term by the potential

$$\tilde{V}_{rot}(x) = \eta \left(D_0 + D_1 e^{-\delta x} + D_2 e^{-2\delta x} \right), \quad (139)$$

where $\delta = ar_e$ and D_i is the coefficients ($i = 0, 1, 2$). In this point, the expression of Eq.(139) can be expanded up to the terms x^3

$$\tilde{V}_{rot}(x) = \eta \left(D_0 + D_1 \left(1 - \delta x + \frac{\delta^2 x^2}{2!} - \frac{\delta^3 x^3}{3!} + \dots \right) + D_2 \left(1 - 2\delta x + \frac{4\delta^2 x^2}{2!} - \frac{8\delta^3 x^3}{3!} + \dots \right) \right), \quad (140)$$

$$\tilde{V}_{rot}(x) = \eta \left(D_0 + D_1 + D_2 - x(D_1\delta + 2D_2\delta) + x^2 \left(D_1 \frac{\delta^2}{2} + 2D_2\delta^2 \right) - x^3 \left(D_1 \frac{\delta^3}{6} + D_2 \frac{4\delta^3}{3} \right) + \dots \right). \quad (141)$$

Combining equal powers of Eqs.(137) and (141) we obtain the relations between the coefficients and the parameter δ as follows

$$\begin{aligned} D_0 &= 1 - \frac{3}{\delta} + \frac{3}{\delta^2} \\ D_1 &= \frac{4}{\delta} - \frac{6}{\delta^2} \\ D_2 &= -\frac{1}{\delta} + \frac{3}{\delta^2}. \end{aligned} \quad (142)$$

We now can take the potential \tilde{V}_{rot} instead of the true rotational potential V_{rot} and solve the SE for $\ell \neq 0$ in Eq.(136).

In order to apply the NU method, we rewrite Eq.(136) by using a new variable of the form $s = e^{-\delta x}$ and $U(r) \rightarrow \psi(s)$,

$$\frac{d^2\psi(s)}{ds^2} + \frac{1}{s} \frac{d\psi(s)}{ds} + \frac{2\mu r_e^2}{\hbar^2 \delta^2 s^2} \left[(E - \eta D_0) + (2D_e - \eta D_1)s - (D_e + \eta D_2)s^2 \right] \psi(s) = 0. \quad (143)$$

By introducing the following dimensionless parameters

$$\begin{aligned}\alpha &= -\frac{2\mu r_e^2(E_{nl} - \eta D_0)}{\hbar^2 \delta^2}, \\ \beta &= \frac{2\mu r_e^2(2D_e - \eta D_1)}{\hbar^2 \delta^2}, \\ \gamma &= \frac{2\mu r_e^2(D_e + \eta D_2)}{\hbar^2 \delta^2},\end{aligned}\quad (144)$$

which leads to the main equation defined in Eq.(4), we can rearrange the SE:

$$\frac{d^2\psi}{ds^2} + \frac{1}{s} \frac{d\psi}{ds} + \frac{1}{s^2} [-\gamma s^2 + \beta s - \alpha] \psi(s) = 0. \quad (145)$$

After the comparison of Eq.(4) with Eq.(145), we obtain the corresponding polynomials as

$$\begin{aligned}\tilde{\tau}(s) &= 1, \\ \sigma(s) &= s, \\ \tilde{\sigma}(s) &= -\gamma s^2 + \beta s - \alpha.\end{aligned}\quad (146)$$

Substituting these polynomials into Eq.(18), we obtain the polynomial $\pi(s)$;

$$\pi(s) = \pm \sqrt{\gamma s^2 + (k - \beta)s + \alpha} \quad (147)$$

taking $\sigma'(s) = 1$. The discriminant of the upper expression under the square root has to be zero. Hence, the expression becomes the square of a polynomial of first degree;

$$(k - \beta)^2 - 4\alpha\beta = 0. \quad (148)$$

When the required arrangements are prepared with respect to the constant k , its double roots are derived as $k_{\pm} = \beta \pm 2\sqrt{\alpha\gamma}$. Substituting k_{\pm} into Eq.(147), the following four possible forms of the $\pi(s)$ are obtained

$$\pi(s) = \pm \begin{cases} (\sqrt{\gamma}s + \sqrt{\alpha}), & \text{for } k_+ = \beta + 2\sqrt{\alpha\gamma} \\ (\sqrt{\gamma}s - \sqrt{\alpha}), & \text{for } k_- = \beta - 2\sqrt{\alpha\gamma}. \end{cases} \quad (149)$$

We just select one of four possible forms of the $\pi(s)$, i.e, $\pi(s) = -(\sqrt{\gamma}s - \sqrt{\alpha})$ for $k_- = \beta - 2\sqrt{\alpha\gamma}$, because it would be provided a negative derivative of $\tau(s)$ given in Eq.(9). Hence, the $\tau(s)$ satisfies the requirement below

$$\begin{aligned}\tau(s) &= 1 + 2\sqrt{\alpha} - 2\sqrt{\gamma} s, \\ \tau'(s) &= -2\sqrt{\gamma} < 0.\end{aligned}\quad (150)$$

From Eq.(17) we obtain

$$\lambda = \beta - 2\sqrt{\alpha\gamma} - \sqrt{\gamma}. \quad (151)$$

and from Eq.(26) we also get

$$\lambda_n = 2n\sqrt{\gamma}. \quad (152)$$

It is seen that the parameter α has the following form

$$\alpha = \left[\frac{\beta}{2\sqrt{\gamma}} - \left(n + \frac{1}{2} \right) \right]^2, \quad (153)$$

remembering the expression $\lambda = \lambda_n$. Substituting the values of α , β and γ into Eq.(153), we can determine the energy spectrum E as

$$E = \frac{\hbar^2 \ell(\ell+1)}{2\mu r_e^2} \left(1 - \frac{3}{ar_e} + \frac{3}{a^2 r_e^2} \right) - \frac{\hbar^2 a^2}{2\mu} \left[\frac{\beta}{2\sqrt{\gamma}} - \left(n + \frac{1}{2} \right) \right]^2, \quad (154)$$

where

$$\frac{\beta}{2\sqrt{\gamma}} = \frac{1}{a^2 \sqrt{\gamma}} \left[\frac{2\mu D_e}{\hbar^2} - \frac{\ell(\ell+1)}{r_e^2} \left(\frac{2}{ar_e} - \frac{3}{a^2 r_e^2} \right) \right]. \quad (155)$$

The last equation indicates the energy spectrum of the Morse potential. The derivative of this energy expression according to n gives an idea about the maximum vibrational quantum number so that the result is $n_{max} = \beta/2\sqrt{\gamma} - 1/2$ (Berkdemir & Sever, 2009; Zhang et al., 2011).

Let us now find the corresponding wavefunction of the Morse potential. A simple calculation reveals that $\phi(s)$ can be calculated by recalling Eq.(7) and submitting the $\sigma(s) = s$ and the $\pi(s) = -(\sqrt{\gamma}s - \sqrt{\alpha})$;

$$\phi(s) = s^{\sqrt{\alpha}} e^{-\sqrt{\gamma}s}, \quad (156)$$

which is one of the separable parts of the wavefunction $\psi(s) = \phi(s)y_n(s)$. The polynomial solution of the hypergeometric-type function $y_n(s)$ depends on the determination of the weight function $\rho(s)$ ($[\sigma(s)\rho(s)]' = \tau(s)\rho(s)$). Thus, $\rho(s)$ is calculated as

$$\rho(s) = s^{2\sqrt{\alpha}} e^{-2\sqrt{\gamma}s}. \quad (157)$$

Substituting Eq.(157) into the Rodrigues' formula given in Eq.(27), the other separable part of the wavefunction $\psi(s)$ is given in the following form

$$y_n(s) = B_n s^{-2\sqrt{\alpha}} e^{2\sqrt{\gamma}s} \frac{d^n}{ds^n} \left[s^{(n+2\sqrt{\alpha})} e^{-2\sqrt{\gamma}s} \right]. \quad (158)$$

The polynomial solution of $y_n(s)$ in Eq.(158) is expressed in terms of the associated Laguerre Polynomials, which is one of the orthogonal polynomials, that is

$$y_n(s) \equiv L_n^{2\sqrt{\alpha}}(2\sqrt{\gamma}s). \quad (159)$$

Combining the Laguerre polynomials and $\phi(s)$ in Eq.(155), the radial wavefunction are constructed as

$$\psi(s) = N_{n\ell} s^{\sqrt{\alpha}} e^{-\sqrt{\gamma}s} L_n^{2\sqrt{\alpha}}(2\sqrt{\gamma}s), \quad (160)$$

where $N_{n\ell}$ is the normalization constant.

4.5 Hulthen potential

One of the objects of this book chapter is to investigate the solution of the SE with the Hulthen potential (Hulthen, 1942; Rosenfeld, 1948) that is given in the form;

$$V(r) = -\frac{K}{\kappa} \frac{1}{e^{\frac{r}{\kappa}} - 1}, \quad (161)$$

where K and κ are the strength and the range parameter of the potential (on the other word, $1/\kappa$ is known the screening parameter regarding with the potential), respectively. The Hulthen potential has an attractive Coulombic behavior for small values of r with respect to κ , i.e., $r \ll \kappa$. To see this behavior let us focus the exponential term of the Hulthen potential. If the values of the radial variable r are smaller than those of the κ , the exponential term could be expanded into the Taylor series (Abramowitz & Stegun, 1970), i.e., $e^{\frac{r}{\kappa}} = 1 + r/\kappa + \frac{1}{2!}(r/\kappa)^2 + \frac{1}{3!}(r/\kappa)^3 + \dots$ and the higher order terms in the series could be neglected according to the first two terms. So the exponential term is now expressed as $e^{\frac{r}{\kappa}} \approx 1 + r/\kappa$. Inserting this term into Eq.(161), one can reach the attractive Coulomb potential, i.e., $V(r) = -K/r$. Thus, the K can be identified with the atomic number (see Section 4.2 for a comparison). On the other hand, for the large values of r , i.e., $r \gg \kappa$, the exponential term would be larger according to the number 1 which is seen in the denominator of the Hulthen potential and hence the number 1 would be neglected. Therefore, the Hulthen potential would be reduced to $V(r) = -\frac{K}{\kappa} e^{-\frac{r}{\kappa}}$.

The Hulthen potential has been used in several branches of physics such as nuclear and particle, atomic, molecular and chemical physics (Durand & Durand, 1981; Xu et al., 2006; Bitensky et al., 1997; Jia et al., 2000; Olson & Micha, 1978). Moreover, its discrete and continuum states have been studied by a variety of techniques such as the supersymmetry and shape invariance property (Varshni, 1990; Filho & Ricotta, 1995; Qian et al., 2002). The solution of the SE for a particle in the Hulthen potential can not be obtained exactly for the case of $\ell \neq 0$ whereas we have an exact solution for the case of $\ell = 0$, namely s-wave solution (Flügge, 1971). To find an approximate solution of the SE with the Hulthen potential, we have to rely on an approximation for the centrifugal term. How can we do that? Let us look at below.

The Hulthen potential given in Eq.(161) can be written in the following form if we recompile it,

$$V(r) = -\frac{K}{\kappa} \frac{e^{-r/\kappa}}{1 - e^{-r/\kappa}}. \quad (162)$$

Inserting Eq.(162) into Eq.(42), we have

$$\frac{d^2 R(r)}{dr^2} + \frac{2}{r} \frac{dR(r)}{dr} + \frac{2\mu}{\hbar^2} \left[E + \frac{K}{\kappa} \frac{e^{-r/\kappa}}{1 - e^{-r/\kappa}} - \frac{\hbar^2 \ell(\ell + 1)}{2\mu r^2} \right] R(r) = 0. \quad (163)$$

We now want to obtain the solution of Eq.(163) using the NU method. If we define

$$R(r) = \frac{U(r)}{r}, \quad (164)$$

Eq.(163) becomes

$$\frac{d^2 U(r)}{dr^2} + \left[\frac{2\mu}{\hbar^2} \left(E + \frac{K}{\kappa} \frac{e^{-r/\kappa}}{1 - e^{-r/\kappa}} \right) - \frac{\ell(\ell + 1)}{r^2} \right] U(r) = 0. \quad (165)$$

This equation is similar to the s-wave SE for the Hulthen potential, except for the additional term $\frac{\ell(\ell+1)}{r^2}$, which is commonly mentioned as a centrifugal term. To solve Eq.(165), we can think about an approximation regarding with the centrifugal term as follows (Greene & Aldrich, 1976; Qiang & Dong, 2007)

$$\frac{\ell(\ell+1)}{r^2} \approx \frac{\ell(\ell+1)e^{-r/\kappa}}{\kappa^2(1-e^{-r/\kappa})^2}. \quad (166)$$

The present approximation is just valid for the short-range potentials (i.e., large κ and small ℓ) but not for the long-range potentials (i.e., small κ and large ℓ). Nevertheless it provides good results, which are in agreement with the previously reported numerical integration method (Lucha & Schöberl, 1999). Moreover, in order to improve the accuracy of this approximation, a different approximation scheme has been recently proposed for the centrifugal term (Ikhdaïr, 2009; 2011). Readers are strongly encouraged to review these studies.

After replacing the term $\ell(\ell+1)/r^2$ by its approximation $\frac{\ell(\ell+1)e^{-r/\kappa}}{\kappa^2(1-e^{-r/\kappa})^2}$ and the transformation $s = e^{-r/\kappa}$ (and also $U(r) \rightarrow \psi(s)$), Eq.(165) becomes

$$\frac{d^2\psi(s)}{ds^2} + \frac{(1-s)}{s(1-s)} \frac{d\psi(s)}{ds} + \frac{1}{s^2(1-s)^2} [-(\alpha + \beta)s^2 + (2\alpha + \beta - \gamma)s - \alpha]\psi(s) = 0 \quad (167)$$

where

$$\begin{aligned} \alpha &= -\frac{2\mu E\kappa}{\hbar^2}, \\ \beta &= \frac{2\mu K\kappa}{\hbar^2}, \\ \gamma &= \ell(\ell+1). \end{aligned} \quad (168)$$

By comparing Eq.(167) with the main equation that comes from the NU method, Eq.(4), we can define the following polynomials

$$\begin{aligned} \tilde{\tau}(s) &= 1 - s, \\ \sigma(s) &= s(1 - s), \\ \tilde{\sigma}(s) &= -(\alpha + \beta)s^2 + (2\alpha + \beta - \gamma)s - \alpha. \end{aligned} \quad (169)$$

Inserting these polynomials into Eq.(18), we have

$$\pi(s) = -\frac{s}{2} \pm \frac{1}{2} \sqrt{[1 + 4(\alpha + \beta - k)]s^2 - 4(2\alpha + \beta - \gamma - k)s + 4\alpha} \quad (170)$$

The discriminant of the expression under the square root in the above equation has to be set equal to zero. Therefore, it becomes

$$\Delta = 16(2\alpha + \beta - \gamma - k)^2 - 16[1 + 4(\alpha + \beta - k)]\alpha = 0, \quad (171)$$

and the two roots of k are obtained

$$k_{\pm} = \beta - \gamma \pm \sqrt{\alpha(1 + 4\gamma)}. \quad (172)$$

Substituting the double roots of k_{\pm} into Eq.(170), the four possible forms of the $\pi(s)$ for either k_+ or k_- are derived as follows

$$\pi(s) = -\frac{s}{2} \pm \frac{1}{2} \begin{cases} [(2\sqrt{\alpha} - \sqrt{1+4\gamma})s - 2\sqrt{\alpha}] & \text{for } k_+ = \beta - \gamma + \sqrt{\alpha(1+4\gamma)} \\ [(2\sqrt{\alpha} + \sqrt{1+4\gamma})s - 2\sqrt{\alpha}] & \text{for } k_- = \beta - \gamma - \sqrt{\alpha(1+4\gamma)}. \end{cases} \quad (173)$$

In order to obtain a physical solution we have to ensure that the polynomial $\tau(s) = \tilde{\tau}(s) + 2\pi(s)$ must satisfy a negative derivative. For this reason, we select the $\pi(s)$;

$$\pi(s) = -\frac{s}{2} - \frac{1}{2} \left[(2\sqrt{\alpha} + \sqrt{1+4\gamma})s - 2\sqrt{\alpha} \right], \quad (174)$$

for $k_- = \beta - \gamma - \sqrt{\alpha(1+4\gamma)}$. The following track in this selection is to achieve the condition $\tau'(s) < 0$. Therefore $\tau(s)$ is written

$$\tau(s) = 1 - 2s - \left[(2\sqrt{\alpha} + \sqrt{1+4\gamma})s - 2\sqrt{\alpha} \right], \quad (175)$$

and then its negative derivative becomes

$$\tau'(s) = -(2 + 2\sqrt{\alpha} + \sqrt{1+4\gamma}) < 0. \quad (176)$$

We can also write down the $\lambda = k_- + \pi'(s)$ and $\lambda_n = -n\tau'(s) - n(n-1)\sigma''(s)/2$, keeping in our mind that $\lambda = \lambda_n$;

$$\lambda = \beta - \gamma - \frac{1}{2}(1 + 2\sqrt{\alpha}) \left(1 + \sqrt{1+4\gamma} \right) = n \left[1 + 2\sqrt{\alpha} + n + \sqrt{1+4\gamma} \right], \quad n = 0, 1, 2, \dots \quad (177)$$

After bring back α , β and γ which are defined in Eq.(168) and simple manipulations, we have the energy spectrum of the Hulthen potential (Agboola, 2011)

$$E = -\frac{\hbar^2}{2\mu} \left[\frac{(K\mu/\hbar^2)}{n + \ell + 1} - \frac{n + \ell + 1}{2\kappa} \right]^2. \quad (178)$$

If we take into account the limitation of $\kappa \rightarrow \infty$, we have $E_n = -\frac{\mu}{2\hbar^2} [K/(n + \ell + 1)]^2$. This is the energy spectrum of the Coulomb potential we have investigated in Section 4.2.

We can now apply the relationships given by Eq.(7) and Eq.(27) through Eq.(28) to obtain the wavefunction $\psi(s)$. Therefore, the relevant polynomials are given

$$\phi(s) = s^{\sqrt{\alpha}}(1-s)^{\ell+1}, \quad (179)$$

$$\rho(s) = s^{2\sqrt{\alpha}}(1-s)^{2\ell+1}, \quad (180)$$

$$y_n(s) = B_n s^{-2\sqrt{\alpha}}(1-s)^{-(2\ell+1)} \frac{d^n}{ds^n} \left[s^{n+2\sqrt{\alpha}}(1-s)^{n+2\ell+1} \right] \equiv P_n^{(2\sqrt{\alpha}, 2\ell+1)}(1-2s). \quad (181)$$

So the wavefunction $\psi(s)$ is written as

$$\psi(s) = N_{n\ell} s^{\sqrt{\alpha}} (1-s)^{\ell+1} P_n^{(2\sqrt{\alpha}, 2\ell+1)}(1-2s), \quad (182)$$

where $N_{n\ell}$ is the normalization constant and $P_n^{(2\sqrt{\alpha}, 2\ell+1)}(1-2s)$ is the Jacobi polynomials (Szegő, 1934). As a reminder notice, the relationship between the $\psi(s)$ and the $R(r)$ is $\psi(s) \equiv rR(r)$ with the transformation of $s = e^{-r/\kappa}$.

5. Conclusion

An exact solution of the SE is not a practical manner, except for the simplest of potential energy functions. In most cases of practical interest, we can just settle for an approximate solution. To overcome various types of problems in quantum mechanics, we have to apply several methods or approximations to solve the SE appropriately. One of this method is introduced by A. F. Nikiforov and V. B. Uvarov. The solution range of this method is limited by the hypergeometric-type second-order differential equations. We know that the time-independent SE has the second-order differential equation in the *Schrödinger picture* as well. Therefore, in this book chapter we confined our attention to this equation and its exact or approximate solutions for the selected potentials such as Harmonic oscillator, Coulomb, Kratzer, Morse and Hulthen potentials. The solution meant that we have obtained the energy spectrum and the corresponding wavefunction of a particle subject to one of these potentials.

6. References

- Schrödinger, E. (1926). *Naturwiss*, 14, 664.
- Nikiforov, A.V. & Uvarov, V.B. (1988). *Special Functions of Mathematical Physics*, Birkhauser, Basel.
- Tang, C.L. (2005). *Fundamentals of Quantum Mechanics: For Solid State Electronics and Optics*, Cambridge University Press, ISBN-13 978-0-521-82952-6, Cambridge.
- Levine, I.N. (2008). *Quantum Chemistry*, Prentice Hall, ISBN: 978-0136131069.
- Flügge, S. (1971). *Practical Quantum Mechanics II*, Springer, Berlin.
- Adams, B.G. (1994). *Algebraic Approach to Simple Quantum Systems. With Applications to Perturbation Theory*, Springer, New York.
- Iachello, F. & Levine, R.D. (1995). *Algebraic Theory of Molecules*, Oxford University Press, New York.
- Iachello, F. & Oss, S. (1996). *J. Chem. Phys.* 104, 6954.
- Iachello, F. & Ibrahim, M. (1998). *J. Phys. Chem. A.* 102, 9427-9432.
- Frank, A. & Isacker, P. Van. (1994). *Algebraic Methods in Molecular and Nuclear Structure Physics*, Wiley, New York.
- Infeld, L. & Hull, T.E. (1951). *Rev. Mod. Phys.* 23, 21.
- Szegő, G. (1939). *Orthogonal Polynomials*. American Mathematical Society, New York.
- Büyükkilic, F.; Egrifes, H. & Demirhan, D. (1997). Solution of the Schrödinger equation for two different molecular potentials by the Nikiforov-Uvarov method. *Theo. Chem. Acc.*, 98, (192-196).
- Kratzer, A. (1920). *Z. Physik*, 3, 289.
- Herzberg, G. (1950). *Molecular Spectra and Molecular Structure: I. Spectra of Diatomic Molecules*, New York, Van Nostrand-Reinhold.

- Berkdemir, C; Berkdemir, A. & Han, J. (2006). Bound state solutions of the Schrödinger equation for modified Kratzer's molecular potential. *Chem. Phys. Lett.*, 417, 326-329.
- Fues, E. (1926). *Ann. Physik*, 80, 367.
- Pliva, J. (1999). A Closed Rovibrational Energy Formula Based on a Modified Kratzer Potential. *J. Mol. Spectrosc.*, 193, 7-14.
- Berkdemir, C. & Sever, R. (2009). Modified ℓ -states of diatomic molecules subject to central potentials plus an angle-dependent potential. *J. Math. Chem.*, 46, 1122-1136.
- Fernandez, F.M. (2011). Comment on "Non-relativistic treatment of diatomic molecules interacting with generalized Kratzer potential in hyperspherical coordinates". *J. Phys. A: Math. Theor.*, 44, 348001.
- Morse, P.M. (1929). Diatomic molecules according to the wave mechanics. II. Vibrational levels. *Phys. Rev.*, 34, 57-64.
- Berkdemir, C. & Han, J. (2005). Any ℓ -state solutions of the Morse potential through the Pekeris approximation and Nikiforov-Uvarov method. *Chem. Phys. Lett.*, 409, (203-207).
- Zuniga, J.; Bastida, A. & Requena, A. (2008). An analytical perturbation treatment of the rotating Morse oscillator. *J. Phys. B: At. Mol. Opt. Phys.*, 41, 105102.
- Pekeris, C.L. (1934). The Rotation-Vibration Coupling in Diatomic Molecules. *Phys. Rev.*, 45, 98-103.
- Zhang, L.H.; Li, X.P. & Jia, C.S. (2011). Approximate Solutions of the Schrödinger Equation with the Generalized Morse Potential Model Including the Centrifugal Term. *Int. J. Quan. Chem.*, 111, 1870-1878.
- Hulthen, L. (1942). *Ark. Mat. Astron. Fys. A*, 28, 5. & Hulthen, L. (1942). *Ark. Mat. Astron. Fys. B*, 29, 1.
- Rosenfeld, L. (1948). *Nuclear Forces, Vol. 1*. North. Holland Publishing Co., Amsterdam.
- Abramowitz, M. & Stegun, I.A. (1970). *Handbook of Mathematical Functions with Formulas, Graphs, and Mathematical Tables*, Dover Publications, Ninth printing, New York.
- Durand, B. & Durand, L. (1981). Duality for heavy-quark systems. *Phys. Rev. D*, 23, 1092-1102.
- Xu, T; Cao, Z.Q.; Ou, Y.C.; Shen, Q.S. & Zhu, G.L. (2006). Critical radius and dipole polarizability for a confined system. *Chin. Phys.*, 15, 1172-1176.
- Bitensky, I.S.; Ferleger, V.K. & Wojciechowski, I.A. (1997). Distortion of H₂ potentials by embedding into an electron gas at molecule scattering by a metal surface. *Nucl. Instr. and Methods in Phys. Res. B*, 125, 201-206.
- Jia, C.S.; Wang, J.Y.; He, S. & Sun, L.T. (2000). Shape invariance and the supersymmetry WKB approximation for a diatomic molecule potential. *J. Phys. A*, 33, 6993-6998.
- Olson, J.A. & Micha, D.A. (1978). Transition operators for atom-atom potentials: The Hilbert-Schmidt expansion. *J. Chem. Phys.*, 68, 4352.
- Varshni, Y.P. (1990). Eigenenergies and oscillator strengths for the Hulthen potential. *Phys. Rev. A*, 41, 4682-4689.
- Filho, E.D. & Ricotta, R.M. (1995). Supersymmetry, variational method and Hulthen potential. *Mod. Phys. Lett. A*, 10, 1613-1618.
- Qian, S.W.; Huang, B.W. & Gu, Z.Y. (2002). Supersymmetry and shape invariance of the effective screened potential. *New J. Phys.*, 4, 13.1.
- Greene, R.L. & Aldrich, C. (1976). Variational wave functions for a screened Coulomb potential. *Phys. Rev. A*, 14, 2363-2366.

- Qiang, W.C. & Dong, S.H. (2007). Analytical approximations to the solutions of the Manning-Rosen potential with centrifugal term. *Phys. Lett. A*, 368, 13-17.
- Lucha, W. & Schöberl, F.F. (1999). Solving the Schrödinger equation for bound states with Mathematica 3.0. *Int. J. Mod. Phys. C*, 10, 607-619.
- Ikhdaïr, S.M. (2009). An improved approximation scheme for the centrifugal term and the Hulthen potential. *Eur. Phys. J. A*, 39, 307-314.
- Ikhdaïr, S.M. (2011). On the bound-state solutions of the Manning-Rosen potential including an improved approximation to the orbital centrifugal term. *Phys. Scr.*, 83, 015010.
- Agboola, D. (2011). Schrödinger Equation with Hulthen Potential Plus Ring-Shaped Potential. *Commun. Theor. Phys.*, 55, 972-976.

Solutions for Time-Dependent Schrödinger Equations with Applications to Quantum Dots

Ricardo J. Cordero-Soto
California Baptist University
USA

1. Introduction

In Ref.-(9), the authors study and solve the time-dependent Schrödinger equation

$$i \frac{\partial \psi}{\partial t} = H(t) \psi \quad (1)$$

where

$$H = -a(t) \frac{\partial^2}{\partial x^2} + b(t) x^2 - i \left(c(t) x \frac{\partial}{\partial x} + d(t) \right) \quad (2)$$

and where $a(t)$, $b(t)$, $c(t)$, and $d(t)$ are real-valued functions of time t only; see Refs.-(9), (10), (11),(29), (35), (39), (49), (50), and Ref.-(51) for a general approach and currently known explicit solutions. The solution (see Ref.-(9) for details) is given by

$$\psi(x, t) = \int_{-\infty}^{\infty} G(x, y, t) \psi_0(y) dy \quad (3)$$

where the Green's function, or particular solution is given by

$$G(x, y, t) = \frac{1}{\sqrt{2\pi i \mu(t)}} e^{i(\alpha(t)x^2 + \beta(t)xy + \gamma(t)y^2)}. \quad (4)$$

The time-dependent functions are found via a substitution method that reduces eqs.- (1)-(2) to a system of differential equations (see Ref. (9)):

$$\frac{d\alpha}{dt} + b(t) + 2c(t)\alpha + 4a(t)\alpha^2 = 0, \quad (5)$$

$$\frac{d\beta}{dt} + (c(t) + 4a(t)\alpha(t))\beta = 0, \quad (6)$$

$$\frac{d\gamma}{dt} + a(t)\beta^2(t) = 0, \quad (7)$$

where the first equation is the familiar Riccati nonlinear differential equation; see, for example, Refs.-(21), (45), (56). This system is explicitly integrable up to the function $\mu(t)$ which satisfies the following so-called characteristic equation

$$\mu'' - \tau(t)\mu' + 4\sigma(t)\mu = 0 \quad (8)$$

with

$$\tau(t) = \frac{a'}{a} - 2c + 4d, \quad \sigma(t) = ab - cd + d^2 + \frac{d}{2} \left(\frac{a'}{a} - \frac{d'}{d} \right). \quad (9)$$

This equation must be solved subject to the initial data

$$\mu(0) = 0, \quad \mu'(0) = 2a(0) \neq 0 \quad (10)$$

in order to satisfy the initial condition for the corresponding Green's function. The time-dependent coefficients are given by the following equations:

$$\alpha(t) = \frac{1}{4a(t)} \frac{\mu'(t)}{\mu(t)} - \frac{d(t)}{2a(t)}, \quad (11)$$

$$\beta(t) = -\frac{1}{\mu(t)} \exp \left(-\int_0^t (c(\tau) - 2d(\tau)) d\tau \right), \quad (12)$$

$$\begin{aligned} \gamma(t) = & \frac{a(t)}{\mu(t)\mu'(t)} \exp \left(-2\int_0^t (c(\tau) - 2d(\tau)) d\tau \right) + \frac{d(0)}{2a(0)} \\ & - 4\int_0^t \frac{a(\tau)\sigma(\tau)}{(\mu'(\tau))^2} \left(\exp \left(-2\int_0^\tau (c(\lambda) - 2d(\lambda)) d\lambda \right) \right) d\tau. \end{aligned} \quad (13)$$

Time dependence in the Hamiltonian has been studied in the context of various applications such as uniform magnetic fields Refs.-(9), (16), (28), (31), (32), (34), (36), time-periodic potentials and quantum dots Ref.-(8) (see also Ref.-(12) for a list of references and applications). Here, we present a general time-dependent Hamiltonian that has applications to the study of quantum devices such as quantum dots. Often described as artificial atoms, quantum dots are tools that allow the study of quantum behavior at the nanometer scale (see Ref.-(23)). This size is larger than the typical atomic scale that exhibits quantum behavior. Because of the larger size, the physics are closer to classical mechanics but still small enough to show quantum phenomena (see Ref.-(23)). Furthermore, their use extends into biological applications. In particular quantum dots are used as fluorescent probes in biological detection since these devices provide bright, stable, and sharp fluorescence (see Ref.-(6)).

Using methods similar to the approach in Ref.-(12), we discuss the uniqueness of Schwartz solutions to the Schrödinger Equation of this quantum dot Hamiltonian. In Ref.-(12) the authors seek to find Quantum Integrals of motion of various time-dependent Hamiltonians. Specifically, the authors seek quantum integrals of motion for the time-dependent Schrödinger equation

$$i\frac{\partial\psi}{\partial t} = H(t)\psi \quad (14)$$

with variable quadratic Hamiltonians of the form

$$H = a(t)p^2 + b(t)x^2 + d(t)(px + xp), \quad (15)$$

where $p = -i\partial/\partial x$, $\hbar = 1$ and $a(t)$, $b(t)$, $d(t)$ are some real-valued functions of time only (see, for example, Refs.-(13), (30), (34), (36), (37), (57), (58) and references therein). A related energy operator E is defined in a traditional way as a quadratic in p and x operator that has constant expectation values (see Ref.-(16)):

$$\frac{d}{dt} \langle E \rangle = \frac{d}{dt} \int_{-\infty}^{\infty} \psi^* E \psi dx = 0. \quad (16)$$

Such quadratic invariants are not unique. In Ref.-(12), the simplest energy operators are constructed for several integrable models of the damped and modified quantum oscillators. Then an extension of the familiar Lewis–Riesenfeld quadratic invariant is given to the most general case of the variable non-self-adjoint quadratic Hamiltonian (see also Refs.-(30), (57), (58)). The authors use the Invariants to construct positive operators that help prove uniqueness of the corresponding Cauchy initial value problem (IVP) for the models as a small contribution to the area of evolution equations.

In the present paper, the author will follow a similar approach in first proving the uniqueness of the IVP for a reduced Hamiltonian (see eq.-(20)). Then the author will use a gauge transformation to extend the uniqueness to IVP of the Quantum Dot Hamiltonian, eq.-(17). Furthermore, the gauge transformation will also simplify the general solution previously obtained in Ref.-(9).

2. A quantum dot model

Essentially, a quantum dot is a small box with electrons. The box is coupled via tunnel barriers to a source and drain reservoir (see Refs.-(23), (17)) with which particles can be exchanged. When the size of this so-called box is comparable to the wavelength of the electrons that occupy it, the energy spectrum is discrete, resembling atoms. This is why quantum dots are artificial atoms in a sense. Vladimiro Mujica at Arizona State University has suggested that the following model is of use to Floquet Theory as well as the theory of Semiconductor quantum dots:

$$H = a(t) p^2 + b(t) x^2 - id(t). \quad (17)$$

This Hamiltonian is seen in photon-assisted tunneling in double-well structures and quantum dots (see Ref.-(8) and Refs.-(25), (26), (44), (19), (55)). In particular, the authors in Ref.-(8) consider a single-electron tunneling through double-well structures. The Schrödinger equation proposed by the authors has a Hamiltonian of the form of eq.-(17) where $b(t) = 0$ and

$$d(t) = i(v + \zeta \cos \omega t).$$

Specifically, they use a single-electron Schrödinger equation with time-periodic potential with oscillating barriers. The potential with oscillating barriers is given by

$$V(x, t) = \begin{cases} 0 & \text{(emitter and collector)} \\ V_B + V_1 \cos \omega t & \text{(layers of barriers)} \\ V_W & \text{(layers of well)} \end{cases} \quad (18)$$

or with the oscillating wells it is given by

$$V(x, t) = \begin{cases} 0 & \text{(emitter and collector)} \\ V_B & \text{(layers of barriers)} \\ V_W + V_1 \cos \omega t & \text{(layers of well)} \end{cases} \quad (19)$$

where V_B and V_W are the height and depth of the static barrier and well respectively. $V_1 \cos \omega t$ is the applied field with amplitude V_1 and frequency ω .

2.1 Uniqueness

We wish to obtain uniqueness of solutions of eq.-(1) for eq.-(17) in Schwartz Space. We follow the approach of quantum integrals in Ref.-(12) to first prove the uniqueness of such solutions

for the following Hamiltonian:

$$H_0 = a(t) p^2 + b(t) x^2. \quad (20)$$

In particular, we will show that for eq.-(20),

$$\langle H_0 \rangle = 0 \text{ when } \psi(x, 0) = 0. \quad (21)$$

We first recall that

$$\langle Q \rangle = \int_{-\infty}^{\infty} \psi^*(x, t) Q[\psi(x, t)] dx \quad (22)$$

Since, we have that ψ is in Schwartz space (see the Fourier Transform on \mathbb{R} in Ref.-(48)), it follows that

$$\langle H_0 \rangle = a(t) \langle p^2 \rangle + b(t) \langle x^2 \rangle < \infty. \quad (23)$$

as long as both functions $a(t)$ and $b(t)$ are bounded. Thus, to prove eq.-(21), we will show that

$$\langle p^2 \rangle = \langle x^2 \rangle = 0 \text{ when } \psi(x, 0) = 0. \quad (24)$$

Again, since ψ is in Schwartz space, we have that

$$\frac{d}{dt} \langle Q \rangle = \int_{-\infty}^{\infty} \frac{\partial}{\partial t} (\psi^*(x, t) Q[\psi(x, t)]) dx = \frac{1}{i} \langle QH - H^+Q \rangle \quad (25)$$

for $Q = p, x, px, xp, p^2$ and x^2 .

Given eq.-(25) we have the following ODE system:

$$\begin{aligned} \frac{d}{dt} \langle p^2 \rangle &= -2b(t) \langle px + xp \rangle \\ \frac{d}{dt} \langle x^2 \rangle &= 2a(t) \langle px + xp \rangle \\ \frac{d}{dt} \langle px + xp \rangle &= 4a(t) \langle p^2 \rangle - 4b(t) \langle x^2 \rangle. \end{aligned} \quad (26)$$

If $\psi(x, 0) = 0$, then

$$\begin{aligned} \langle p^2 \rangle_0 &= 0 \\ \langle x^2 \rangle_0 &= 0 \\ \langle px + xp \rangle_0 &= 0. \end{aligned} \quad (27)$$

According to the general theory of homogeneous linear systems of ODE's, we have that

$$\begin{aligned} \langle p^2 \rangle &= 0 \\ \langle x^2 \rangle &= 0 \\ \langle px + xp \rangle &= 0. \end{aligned} \quad (28)$$

Thus, we have shown that eq.-(24) holds, thereby proving eq.-(21). We then use the following (see Ref.-(12)) lemma:

Lemma 1. Suppose that the expectation value

$$\langle H_0 \rangle = \langle \psi, H_0 \psi \rangle \geq 0 \quad (29)$$

for a positive quadratic operator

$$H_0 = f(t) (\alpha(t) p + \beta(t) x)^2 + g(t) x^2 \quad (f(t) \geq 0, g(t) > 0) \quad (30)$$

($\alpha(t)$ and $\beta(t)$ are real-valued functions) vanishes for all $t \in [0, T)$:

$$\langle H_0 \rangle = \langle H_0 \rangle(t) = \langle H_0 \rangle(0) = 0, \quad (31)$$

when $\psi(x, 0) = 0$ almost everywhere. Then the corresponding Cauchy initial value problem

$$i \frac{\partial \psi}{\partial t} = H \psi, \quad \psi(x, 0) = \varphi(x) \quad (32)$$

may have only one solution in Schwartz space.

Since we have proven eq.-(21), we have that H_0 satisfies this lemma, thus proving uniqueness of Schwartz solutions for eq.-(20). By using the gauge-transformation approach in Ref.-(11) we state the following lemma:

Lemma 2. Let $\tilde{\psi}(x, t)$, with $\tilde{\psi}(x, 0)$ in Schwartz space, solve the following time-dependent Schrödinger equation:

$$i \frac{\partial \tilde{\psi}}{\partial t} = \tilde{H} \tilde{\psi}, \quad (33)$$

where

$$\tilde{H} = -a(t) \frac{\partial^2}{\partial x^2} + b(t) x^2 - ic(t) x \frac{\partial}{\partial x}. \quad (34)$$

Then

$$\psi(x, t) = \tilde{\psi}(x, t) \exp\left(-\int_0^t d(s) ds\right) \quad (35)$$

solves eqs.-(1)-(2) for

$$\psi(x, 0) = \tilde{\psi}(x, 0). \quad (36)$$

Proof. Let $\psi(x, t) = \tilde{\psi}(x, t) \exp\left(-\int_0^t d(s) ds\right)$ and assume $\tilde{\psi}(x, t)$ solves (33)-(34), where $\tilde{\psi}(x, 0)$ is in Schwartz space. We differentiate $\psi(x, t)$ with respect to time:

$$i \frac{\partial \psi}{\partial t} = i \frac{\partial \tilde{\psi}}{\partial t} \exp\left(-\int_0^t d(s) ds\right) - id(t) \tilde{\psi}(x, t) \exp\left(-\int_0^t d(s) ds\right). \quad (37)$$

For H given by (2) and \tilde{H} given by (34), we have

$$H = \tilde{H} - id(t), \quad (38)$$

and

$$i \frac{\partial \psi}{\partial t} = \tilde{H} [\tilde{\psi}] \exp\left(-\int_0^t d(s) ds\right) - id(t) \psi. \quad (39)$$

Since

$$\tilde{H} [\tilde{\psi}] \exp\left(-\int_0^t d(s) ds\right) = \tilde{H} \left[\tilde{\psi} \exp\left(-\int_0^t d(s) ds\right) \right] = \tilde{H} [\psi], \quad (40)$$

we have that

$$i \frac{\partial \psi}{\partial t} = \tilde{H} [\psi] - id(t) \psi = H\psi. \tag{41}$$

■

By the method of Ref.-(9) for $d = 0$ we can find $\tilde{\psi}(x, t)$: We simply generate the Green's function for $\tilde{\psi}(x, t)$ by substituting $d = 0$ in eq.-(2). This leads us to a simpler form of the solution previously obtained in Ref.-(9) for eqs.-(1)-(2). Namely,

$$\psi(x, t) = \exp\left(-\int_0^t d(s) ds\right) \int_{-\infty}^{\infty} G(x, y, t) \psi_0(y) dy \tag{42}$$

where

$$G(x, y, t) = \frac{1}{\sqrt{2\pi i \mu(t)}} e^{i(\alpha(t)x^2 + \beta(t)xy + \gamma(t)y^2)} \tag{43}$$

with

$$\alpha(t) = \frac{1}{4a(t)} \frac{\mu'(t)}{\mu(t)}, \tag{44}$$

$$\beta(t) = -\frac{1}{\mu(t)} \exp\left(-\int_0^t c(\tau) d\tau\right), \tag{45}$$

$$\begin{aligned} \gamma(t) = & \frac{a(t)}{\mu(t)\mu'(t)} \exp\left(-2\int_0^t c(\tau) d\tau\right) \\ & - 4\int_0^t \frac{a(\tau)\tilde{\sigma}(\tau)}{(\mu'(\tau))^2} \left(\exp\left(-2\int_0^\tau c(\lambda) d\lambda\right)\right) d\tau. \end{aligned}$$

and $\mu(t)$ is the solution of a *reduced characteristic equation* given by

$$\mu'' - \tilde{\tau}(t)\mu' + 4\tilde{\sigma}(t)\mu = 0, \tag{46}$$

where

$$\tilde{\tau}(t) = \frac{a'}{a} - 2c, \tag{47}$$

$$\tilde{\sigma}(t) = ab \tag{48}$$

and initial conditions are given by eq.-(10).

The Schwartz requirement on the initial condition is necessary to show that eq.-(3) is in fact the solution of eqs.-(1)-(2) since we can justify the interchanging of the time-derivative and integral operators. In particular, we note that

$$\left| \frac{\partial}{\partial t} G(x, y, t) \psi_0(y) \right| = \left| \frac{\partial}{\partial t} \left[A(t) e^{i(\alpha(t)x^2 + \beta(t)xy + \gamma(t)y^2)} \psi_0(y) \right] \right|. \tag{49}$$

Here,

$$A(t) = \frac{1}{\sqrt{2\pi i \mu(t)}}. \tag{50}$$

Thus, eq.-(49) reduces to

$$\left| \left(\frac{\partial A}{\partial t} + Ai \frac{\partial S}{\partial t} \right) \psi_0(y) \right|, \tag{51}$$

where

$$S(x, y, t) = \alpha(t)x^2 + \beta(t)xy + \gamma(t)y^2. \tag{52}$$

Since $\psi_0(y)$ is in Schwartz space, eq.-(51) is also in Schwartz space. It follows that the time-derivative operator can be exchanged with the integral (see Ref.-(1)).

We state the following extension Corollary:

Corollary 3. *Let $\tilde{\psi}(x, t)$, with $\tilde{\psi}(x, 0)$ uniquely solve eqs.-(33)-(34). Then eq.-(35) uniquely solves eqs.-(1)-(2) for eq.-(36).*

This extends the uniqueness of Schwartz Space solutions to eq.-(1) for eq.-(17).

3. Invariants

In Ref.-(12), the authors seek the quantum integrals of motion or dynamical invariants for different time-dependent Hamiltonians. We recall a familiar definition (see, for example, Refs.-(16), (38)). We say that a quadratic operator

$$E = A(t) p^2 + B(t) x^2 + C(t) (px + xp) \quad (53)$$

is a quadratic dynamical invariant of eq.-(2) if

$$\frac{d \langle E \rangle}{dt} = 0 \quad (54)$$

for eq.-(2). We recall from Ref.-(11) that the expectation value of an operator A in quantum mechanics is given by the formula

$$\langle E \rangle = \int_{-\infty}^{\infty} \psi^*(x, t) E(t) \psi(x, t) dx, \quad (55)$$

where the wave function satisfies the time-dependent Schrödinger equation

$$i \frac{\partial \psi}{\partial t} = H \psi. \quad (56)$$

The time derivative of this expectation value can be written as

$$i \frac{d}{dt} \langle E \rangle = i \left\langle \frac{\partial E}{\partial t} \right\rangle + \langle EH - H^\dagger E \rangle, \quad (57)$$

where H^\dagger is the Hermitian adjoint of the Hamiltonian operator H . Our formula is a simple extension of the well-known expression Refs.-(28), (40), (47) to the case of a nonself-adjoint Hamiltonian.

Lemma 1 provides us with a Corollary regarding the relationship between invariants of gauge-related Hamiltonians.

Corollary 4. *Let \tilde{E} be a dynamical invariant of eq.-(34). If $d(t)$ is a real-valued function, then*

$$E = \tilde{E} \exp \left(\int_0^t 2d(s) ds \right) \quad (58)$$

is an invariant of eq.-(2). If $d(t) = i\tilde{d}(t)$ where $\tilde{d}(t)$ is a real-valued function, then \tilde{E} is an invariant of eq.-(2).

Conclusion 5. *While Schrödinger equations have been widely used in quantum mechanics and other related fields such as quantum electrodynamics, Schrödinger equations with time-dependent*

Hamiltonians continue to have applications in a wide area of related fields. It is thus appropriate to consider IVPs that have potential applications to devices such as Quantum Dots. It is thus important to understand the physics of these devices as we realize their great potential in the usage of imaging and other biological applications. Furthermore, quantum dots give us a glimpse of phenomena that unifies classical mechanics with quantum mechanics and thus deserve study in order to further the theoretical understandings of the laws that govern the universe.

4. Acknowledgement

This work would not be possible without the mentorship and guidance of Dr. Sergei Suslov. Furthermore, Dr. Martin Engman was helpful and insightful in the development of some of the techniques of this chapter. This work is also possible because of Dr. Carlos Castillo-Chavéz and his continued support throughout my career. I would like to thank the following National Science Foundation programs for their support throughout the years: Louis Stokes Alliances for Minority Participation (LSAMP): NSF Cooperative Agreement No. HRD-0602425 (WAESO LSAMP Phase IV); Alliances for Graduate Education and the Professoriate (AGEP): NSF Cooperative Agreement No. HRD-0450137 (MGE@MSA AGEP Phase II). I am grateful to California Baptist University for providing funding to make this publication possible. Finally, I would like to thank God and my wife Kathia for her support and encouragement.

5. References

- [1] C. D. Aliprantis and O. Burkinshaw, *Principles of Real Analysis*, third edition, Academic Press, San Diego, London, Boston, 1998.
- [2] R. Askey and S. K. Suslov, *The q -harmonic oscillator and an analogue of the Charlier polynomials*, J. Phys. A 26 (1993) # 15, L693–L698.
- [3] R. Askey and S. K. Suslov, *The q -harmonic oscillator and the Al-Salam and Carlitz polynomials*, Lett. Math. Phys. 29 (1993) #2, 123–132; arXiv:math/9307207v1 [math. CA] 9 Jul 1993.
- [4] N. M. Atakishiyev and S. K. Suslov, *Difference analogues of the harmonic oscillator*, Theoret. and Math. Phys. 85 (1990) #1, 1055–1062.
- [5] L. A. Beauregard, *Propagators in nonrelativistic quantum mechanics*, Am. J. Phys. 34 (1966), 324–332.
- [6] M.P. Bruchez and C.Z. Hotz, *Quantum Dots applications in biology*, Humana Press, 2007.
- [7] T. Cazenave, *Semilinear Schrödinger Equations*, Courant Lecture Notes in Mathematics, 10, New York University Courant Institute of Mathematical Sciences, New York, 2003.
- [8] Li Chun-Lei and Xu Yan, *Influence of time-periodic potentials on electronic transport in double-well structure*, Chin. Phys. B. Vol. 19, No. 5 (2010) 057202.
- [9] R. Cordero-Soto, R. M. Lopez, E. Suazo, and S. K. Suslov, *Propagator of a charged particle with a spin in uniform magnetic and perpendicular electric fields*, Lett. Math. Phys. 84 (2008) #2–3, 159–178.
- [10] R. Cordero-Soto and S. K. Suslov, *The time inversion for modified oscillators*, arXiv:0808.3149v9 [math-ph] 8 Mar 2009, to appear in Theoretical and Mathematical Physics.
- [11] R. Cordero-Soto, E. Suazo, and S. K. Suslov, *Models of damped oscillators in quantum mechanics*, Journal of Physical Mathematics, 1 (2009), S090603 (16 pages)
- [12] R. Cordero-Soto, E. Suazo, and S.K. Suslov, *Quantum integrals of motion for variable quadratic Hamiltonians*, Annals of Physics 325 (2010), 1884–1912.
- [13] V. V. Dodonov, I. A. Malkin, and V. I. Man'ko, *Integrals of motion, Green functions, and coherent states of dynamical systems*, Int. J. Theor. Phys. 14 (1975) # 1, 37–54.

- [14] V. V. Dodonov and V. I. Man'ko, *Coherent states and resonance of a quantum damped oscillator*, Phys. Rev. A 20 (1979) # 2, 550–560.
- [15] V. V. Dodonov and V. I. Man'ko, *Generalizations of uncertainty relations in quantum mechanics*, in: *Invariants and the Evolution of Nonstationary Quantum Systems*, Proceedings of Lebedev Physics Institute, vol. 183, pp. 5–70, Nauka, Moscow, 1987 [in Russian].
- [16] V. V. Dodonov and V. I. Man'ko, *Invariants and correlated states of nonstationary quantum systems*, in: *Invariants and the Evolution of Nonstationary Quantum Systems*, Proceedings of Lebedev Physics Institute, vol. 183, pp. 71-181, Nauka, Moscow, 1987 [in Russian]; English translation published by Nova Science, Commack, New York, 1989, pp. 103-261.
- [17] J.M. Elzerman et al., *Semiconductor Few-Electron Quantum Dots as Spin Qubits*, Lect. Notes Phys. 667, 25-95 (2005).
- [18] R. P. Feynman and A. R. Hibbs, *Quantum Mechanics and Path Integrals*, McGraw–Hill, New York, 1965.
- [19] Fujisawa T and Tarucha S 1997 Superlattices Microstruct. 21 247
- [20] J. Ginibre and G. Velo, *On the class of nonlinear Schrödinger equations* I,II, J. Funcional Analysis, 32 (1979), pp. 1-32, 33-71; III, Ann. Inst. Henri Poincaré Sect. A, 28 (1978), pp. 287-316.
- [21] D. R. Haaheim and F. M. Stein, *Methods of solution of the Riccati differential equation*, Mathematics Magazine 42 (1969) #2, 233–240.
- [22] B. R. Holstein, *The harmonic oscillator propagator*, Am. J. Phys. 67 (1998) #7, 583–589.
- [23] D. Heiss, *Quantum Dots: a Doorway to Nanoscale Physics*, Lect. Notes Phys. 667, Springer, Berlin, 2005.
- [24] T. Kato, *On nonlinear Schrödinger equations*, Ann. Inst. H. Poincaré Phys. Théor., 46 (1987), 113-129.
- [25] Kouwenhoven L P, Johnson A T, van der Vaart N C, Harmans C J P M and Foxon C T 1991 Phys. Rev. Lett. 67 1626
- [26] Kouwenhoven L P, Jauhar S, Orenstein J, McEuen P L, Nagamune Y, Motohisa J and Sakaki H 1994 Phys. Rev. Lett. 73 3443
- [27] L. D. Landau and E. M. Lifshitz, *Mechanics*, Pergamon Press, Oxford, 1976.
- [28] L. D. Landau and E. M. Lifshitz, *Quantum Mechanics: Nonrelativistic Theory*, Pergamon Press, Oxford, 1977.
- [29] N. Lanfear and S. K. Suslov, *The time-dependent Schrödinger equation, Riccati equation and Airy functions*, arXiv:0903.3608v5 [math-ph] 22 Apr 2009.
- [30] P. G. L. Leach, *Berry's phase and wave functions for time-dependent Hamiltonian systems*, J. Phys. A: Math. Gen 23 (1990), 2695–2699.
- [31] H. R. Lewis, Jr., *Classical and quantum systems with time-dependent harmonic-oscillator-type Hamiltonians*, Phys. Rev. Lett. 18 (1967) #13, 510–512.
- [32] H. R. Lewis, Jr., *Motion of a time-dependent harmonic oscillator, and of a charged particle in a class of time-dependent, axially symmetric electromagnetic fields*, Phys. Rev. 172 (1968) #5, 1313–1315.
- [33] H. R. Lewis, Jr., *Class of exact invariants for classical and quantum time-dependent harmonic oscillators*, J. Math. Phys. 9 (1968) #11, 1976–1986.
- [34] H. R. Lewis, Jr., and W. B. Riesenfeld, *An exact quantum theory of the time-dependent harmonic oscillator and of a charged particle in a time-dependent electromagnetic field*, J. Math. Phys. 10 (1969) #8, 1458–1473.
- [35] R. M. Lopez and S. K. Suslov, *The Cauchy problem for a forced harmonic oscillator*, arXiv:0707.1902v8 [math-ph] 27 Dec 2007.

- [36] I. A. Malkin, V. I. Man'ko, and D. A. Trifonov, *Coherent states and transition probabilities in a time-dependent electromagnetic field*, Phys. Rev. D. 2 (1970) #2, 1371–1385.
- [37] I. A. Malkin, V. I. Man'ko, and D. A. Trifonov, *Linear adiabatic invariants and coherent states*, J. Math. Phys. 14 (1973) #5, 576–582.
- [38] I. A. Malkin and V. I. Man'ko, *Dynamical Symmetries and Coherent States of Quantum System*, Nauka, Moscow, 1979 [in Russian].
- [39] M. Meiler, R. Cordero-Soto, and S. K. Suslov, *Solution of the Cauchy problem for a time-dependent Schrödinger equation*, J. Math. Phys. 49 (2008) #7, 072102: 1–27; published on line 9 July 2008, URL: <http://link.aip.org/link/?JMP/49/072102>; see also arXiv: 0711.0559v4 [math-ph] 5 Dec 2007.
- [40] E. Merzbacher, *Quantum Mechanics*, third edition, John Wiley & Sons, New York, 1998.
- [41] P. Nardone, *Heisenberg picture in quantum mechanics and linear evolutionary systems*, Am. J. Phys. 61 (1993) # 3, 232–237.
- [42] A. F. Nikiforov, S. K. Suslov, and V. B. Uvarov, *Classical Orthogonal Polynomials of a Discrete Variable*, Springer–Verlag, Berlin, New York, 1991.
- [43] M. Ohta and G. Todorova, *Remarks on Global Existence and Blowup for Damped Nonlinear Schrödinger equation*, Discrete and Continuous Dynamical Systems 23, (2009) #4, 1313–1325.
- [44] Oosterkamp T H, Kouwenhoven L P, Koolen A E A, VanderVaart N C and Harmans C J P M 1997 Phys. Rev. Lett. 78 1536
- [45] E. D. Rainville, *Intermediate Differential Equations*, Wiley, New York, 1964.
- [46] R. W. Robinett, *Quantum mechanical time-development operator for the uniformly accelerated particle*, Am. J. Phys. 64 (1996) #6, 803–808.
- [47] L.I. Schiff, *Quantum Mechanics*, first edition, McGraw-Hill Book Company, Inc., New York, Toronto, London, 1949.
- [48] E. M. Stein and R. Shakarchi, *Fourier Analysis, An Introduction*, Princeton University Press, Princeton, New Jersey, 2003.
- [49] E. Suazo and S. K. Suslov, *An integral form of the nonlinear Schrödinger equation with variable coefficients*, arXiv:0805.0633v2 [math-ph] 19 May 2008.
- [50] E. Suazo and S. K. Suslov, *Cauchy problem for Schrödinger equation with variable quadratic Hamiltonians*, under preparation.
- [51] E. Suazo, S. K. Suslov, and J. M. Vega, *The Riccati differential equation and a diffusion-type equation*, arXiv:0807.4349v4 [math-ph] 8 Aug 2008.
- [52] S. K. Suslov and B. Trey, *The Hahn polynomials in the nonrelativistic and relativistic Coulomb problems*, J. Math. Phys. 49 (2008) #1, 012104: 1–51; published on line 22 January 2008, URL: <http://link.aip.org/link/?JMP/49/012104>.
- [53] M. Tsutsumi, *Nonexistence of global solutions to the cauchy problem for the damped non-linear Schrödinger equations*, SIAM J. Math. Anal., 15 (1984), 357–366
- [54] N. S. Thomber and E. F. Taylor, *Propagator for the simple harmonic oscillator*, Am. J. Phys. 66 (1998) # 11, 1022–1024.
- [55] van der Wiel W G, de Franceschi S, Elzerman J M, Fujisawa T, Tarucha S and Kouwenhoven L P 2003 Rev. Mod. Phys. 75 1
- [56] G. N. Watson, *A Treatise on the Theory of Bessel Functions*, Second Edition, Cambridge University Press, Cambridge, 1944.
- [57] K. B. Wolf, *On time-dependent quadratic Hamiltonians*, SIAM J. Appl. Math. 40 (1981) #3, 419–431.
- [58] K-H. Yeon, K-K. Lee, Ch-I. Um, T. F. George, and L. N. Pandey, *Exact quantum theory of a time-dependent bound Hamiltonian systems*, Phys. Rev. A 48 (1993) # 4, 2716–2720.

The Group Theory and Non-Euclidean Superposition Principle in Quantum Mechanics

Nicolay V. Lunin
*Volga State Academy of Water Transport, Nizhny Novgorod
Russia*

1. Introduction

One of the unsolved problem in theoretical physics during some decades remains a construction of the complete and closed theory in which quantum mechanics and special relativity would be consistent without divergences and renormalization (Dirac, 1978). It may be assumed that divergences show conservation laws violation in the conventional theories, and a cause for it may be in turn violation of the group-theoretic principles in these theories, in accordance with the Noether theorems. A success of renormalization allows one to believe that the theory without divergences is possible.

This paper is devoted to consideration of possibility to develop the consistent group-theoretic scheme of the quantum mechanics merely. It consists of Introduction, three parts, and Conclusion.

The requirements which allow one to consider the quantum mechanics as a consistent group-theoretic theory are formulated in Introduction.

The Noether theorems set one-to-one correspondence between conservation laws of the variables to be measured, i.e. observables (Dirac, 1958), and groups of symmetries of the solutions transformations of equations for complex wave functions, spinors, matrices and so on in which the space-time properties appear (Olver, 1986). These solutions do not obey to be an observables but the last ones may be constructed as the Hermitian forms corresponding to these observables on their basis. The mathematical tool to express the space-time symmetry properties is the group theory.

Two circumstances connected with the stated above attract attention in the generally accepted schemes of the quantum mechanics.

The exact conservation laws fulfilment is inconceivable in any theoretical scheme under absence of the *complete* set of the Hermitian forms, based on the main equations solutions and its derivatives, each of them would be corresponded to the observables. Some of these Hermitian forms have to be conserved, another have to be changed but all of them have to satisfy to some completeness condition expressed mathematically. The last subject has exceptional significance since if only some part of the unknown complete set of observables really existing is included into the theory, then both physical interpretation and conservation laws would be dependent on the Hermitian forms which are excluded from the theory. Of course, such theory can not be recognized to be the consecutive, complete and closed theory. One of the impressive consequence of the observables complete set and corresponding completeness condition absence is the well known question on the hidden parameters

(Einstein et al., 1935) being discussed up to now (Goldstein, 1998) including experimental investigations (Greenstein & Zajonc, 2006). Moreover, absence of the completeness condition for observables immediately relates to the physical contents of the wave function and its probabilistic interpretation. These subjects are discussed during many years but the uniqueness of the last one has not been proved up to now (Feynman & Hibbs, 1965).

The second question is not so obvious and discussed, the author had not seen the papers on the subject.

The logical foundations of the physical theory having been consistent with causality, require to act of the consequent transformation on the result of the previous one. The mathematical description of this requirement is expressed by means of the operators product in the same order as they act in the physical process to be described.

Transformation operators describing different physical processes map the space-time properties, and the successive products define the binary operation over the transformations set, it is the multiplication, its result depends on the operators order in general case. Therefore, transformations set have to be multiplicative non-commutative groups in the fundamental physical theories.

The elements of the multiplicative non-commutative groups are nonequivalent under the group operation but the physical phenomena, similar to the interference, require to include the non-commutative group elements compositions in which its elements would be equivalent. The results of such kinds compositions have not be dependent on the order of the group elements in it, and have to belong to the same group as two elements entered the compositions at the same time.

In the ordinary superposition principle used in a great number of physical theories the pairwise permutable composition is expressed as the sum of the elements, in particular the elements of the multiplicative non-commutative groups. It means that the second binary operation, the sum, over the group elements is introduced, besides of the multiplication.

Meanwhile, the group is the monoid, i.e. the set with only one binary operation, in accordance with its definition (Zhelobenko & Shtern, 1983). Therefore, the theories in which two binary operations are used over the set of transformations can not be recognized to be the group-theoretic theory. For example, all elements of the unitary group $SU(2)$ describing rotations are unimodular. If one will sum two any elements of the group, the result would not be unimodular, then it does not belong to the group. As a consequence of the Noether theorems it may lead to violation of the conservation laws. The consistent group-theoretic physical theory, in particular quantum mechanics, may be carried out only under fulfilment of all the group definition requirements. So as associativity, existence of the unit and the inverse elements, and, of course, the multiplication as the only binary operation over its elements.

In accordance with the stated above, such theory has to contain at least the pairwise permutable composition over any elements of the non-Abelian Lie groups. Of course, such composition has to turn into the ordinary superposition principle under correspondent parameters area.

Oddly enough that the non-commutativity was not to be a cause of refusal to construct quantum mechanics as the group-theoretic theory, it was only complicating factor (Feynman & Hibbs, 1965). For example, one has only commutative propagators in the double-slit experiment in homogeneous medium, they are multiplied along successive path segments. Nevertheless, even if non-commutativity does not create any difficulties since all propagators belong to the commutative subgroup of the $SU(1,1)$ group, an alternative propagators are added together accordingly to the ordinary superposition principle (Feynman et al., 1963).

Of course, using only multiplication both for successive and alternative propagators, and considering the only Hermitian form $\rho = \chi\chi^*$ as an observable, one can not obtain an "interference" pattern since $\rho = \text{const}$ everywhere.

Nevertheless, the experimental pattern may be obtained without addition of the second operation, as it would be shown below.

Therefore the inclusion of two binary operations over the set of transformations in quantum mechanics (see for example (Landau & Lifshitz, 1963)) means the groundless rejection to construct the last one as the consistent group-theoretic physical theory.

The section 2 contains consideration of the complete set of observables for the stationary Schroedinger equation (Lunin, 1998; 1999). It consists of four bilinear Hermitian forms, being together they satisfy to some identity which means the completeness condition at the same time. Therefore only three of them are independent. Its geometric interpretation in the Euclidean space is proposed. All conservation laws are considered for the free particle described with the Schroedinger equation, it is shown that the successive points where these laws are fulfilled form the spiral line in general case. Transformations of such lines are considered under some simplest potentials. The qualitative explanation of the double-slit experiment when particles go from the source up to detector one by one, and the experimental pattern is formed by isolated point-wise traces is proposed there.

The section 3 contains the most important part of the paper: a short presentation of the non-Euclidean superposition principle deduction. At first there are established the metric of the propagators logarithms space for the stationary Schroedinger equation, it is the Lobachevsky space. Then, mapping the group elements onto the Lobachevsky plane together with the group operation one establishes the additive representation of the $SU(1, 1)$ group in the curved space. Geometric consideration of the subject allows one to develop the symmetric binary composition which is invariable with respect to permutation of two non-commutative group elements and which belongs to the same group as these ones entered the composition (Lunin, 1994). Geometric investigation of this composition with respect to discrete symmetries had also lead to three other compositions, all of them form the non-Euclidean superposition principle, which turns into the ordinary, i.e. the Euclidean, superposition principle in the vicinity of the identity, and applicable up to the Lie groups of arbitrary dimension (Lunin, 1998; 2002). The geometric deduction of all four compositions establishes their geometric contents at the same time.

This section contains also a comparison of these two different rules of the propagators composition for the experiment with two slits arranged at the two different media boundary. It is shown there that the non-Euclidean superposition principle leads to fulfilment of conservation laws everywhere whereas the Euclidean one leads to the same only in some areas. This conclusion is valid also in the case of the homogeneous medium.

The section 4 contains an example of application of the non-Euclidean superposition principle to the physically significant problem of the irreversibility in quantum mechanics (Ginzburg, 1999; Kadomtzev, 2003). All transformations of the time-dependent Schroedinger equation solutions are reversible due to its reversibility, it means that all propagators turn into the inverse ones under time inversion. However, the non-Euclidean superposition principle contains also two binary compositions which do not turn into the inverse ones under inversion of both propagators entered them. This circumstance allowed one to include irreversible processes into the scheme of quantum mechanics. The reversibility of the equation is occurred to be only necessary condition but not quite sufficient for the reversible evolution of the closed physical system.

Thus, the non-Euclidean superposition principle allows coexistence of the reversible and irreversible processes in the closed systems described with only reversible equations (Lunin & Kogan, 2004; 2009).

2. Completeness of observables

To introduce the main and necessary notions for solution the problem mentioned above in the simplest but sufficient way, let us consider the unidimensional Schroedinger equation with real potential for the particle above barrier. According to (Kolkunov, 1969; 1970), and also (Lontano & Lunin, 1991), we shall start with the equation under corresponding conditions at the initial point z_0

$$\frac{d^2\chi(z)}{dz^2} + k^2(z)\chi(z) = 0, \quad \chi(z_0) = \chi_0, \quad \chi'(z_0) = \chi'_0, \quad (1)$$

where $k^2(z) = (2m/\hbar^2)[E - U(z)]$, E and $U(z)$ are energy and real potential respectively. Going over to the pair of first order equations for complex functions

$$\Phi_{\pm}(z) = \frac{k^{1/2}}{\sqrt{2}} \left[\chi \pm \frac{1}{ik} \chi' \right] \quad (2)$$

with corresponding conditions at the initial point z_0 , one has the following matrix equation for $\Phi = \text{column } \|\Phi_+, \Phi_-\|$

$$\Phi'(z) = [ik(z)\sigma_3 + \frac{k'(z)}{2k(z)}\sigma_1]\Phi(z), \quad (3)$$

where σ_s are Pauli matrices including identity one σ_0 , $s = 0, 1, 2, 3$. Let us notice that equation (2.3) may be also obtained by means of staircase approximation (Kolkunov, 1969; 1970). Dividing axis z into segments Δz_i with $k_i = \text{const}$ and steps Δk_i at its common points, requiring continuity of χ_i , χ'_i there, and going over to $\Delta z_i \rightarrow 0$, one has also the equation (2.3). Therefore propagator Q (see below) includes continuity of χ , χ' everywhere.

A solution of (2.3) may be written in the form $\Phi(z) = Q(z, z_0)\Phi(z_0)$, where Q is a propagator, i.e. matrix, transforming $\Phi(z_0)$ into $\Phi(z)$,

$$Q(z, z_0) = T \exp \int_{z_0}^z [ik\sigma_3 + \frac{k'}{2k}\sigma_1] dz. \quad (4)$$

Matrix Q is named as a product integral (Gantmakher, 1988), it is a limit of product of the infinitesimal matrix transformations, in general case they are non-commutative.

Let us consider four bilinear Hermitian forms with respect to Φ , Φ^+ ,

$$j_s(z) = \Phi^+(z)\sigma_s\Phi(z). \quad (5)$$

They satisfy to the identity

$$j_0^2 = j_1^2 + j_2^2 + j_3^2 \quad (6)$$

independently if they are solutions of equation (2.3) or not, therefore only three of them are independent. Let us introduce, accordingly to the direct product definition (Lankaster, 1969), Hermitian matrix

$$J = \|\Phi_+, \Phi_-\| \otimes \|\Phi_+, \Phi_-\| = \left\| \begin{array}{cc} \Phi_+^* \Phi_+ & \Phi_+^* \Phi_- \\ \Phi_-^* \Phi_+ & \Phi_-^* \Phi_- \end{array} \right\| = \frac{1}{2} \left\| \begin{array}{cc} j_0 + j_3 & j_1 - ij_2 \\ j_1 + ij_2 & j_0 - j_3 \end{array} \right\|. \quad (7)$$

Its determinant is equal to zero due to the identity (2.6), it satisfies to relation $J^2 = j_0 J$ which under normalization condition $j_0 = 1$ coincides with definition of the idempotent matrix, therefore the matrix J is similar to the density matrix of pure states (Feynman, 1972). Differentiating expression (2.7) and using equation (2.3) together with its Hermitian conjugate, one obtains

$$J' = ik\{\Phi^+ \otimes \sigma_3 \Phi - \Phi^+ \sigma_3 \otimes \Phi\} + \frac{k'}{2k}\{\Phi^+ \otimes \sigma_1 \Phi + \Phi^+ \sigma_1 \otimes \Phi\}, \quad (8)$$

which is equivalent to four equations for j_s :

$$j'_0 = \frac{k'}{k} j_1, \quad j'_1 = 2k j_2 + \frac{k'}{k} j_0, \quad j'_2 = -2k j_1, \quad j'_3 = 0. \quad (9)$$

Differentiating the identity (2.6) for j_s and taking equations (2.9) into account, we derive the identity also for j'_s and j'_s .

Let us notice that two Hermitian forms, $\rho = \chi\chi^*$ and $j_3 = i(\chi\chi'^* - \chi^*\chi')$, are considered, as a rule, as observables named the density and the current in the generally accepted schemes of quantum mechanics. They are a compositions of only χ and χ' , along with the complex conjugate ones, of course. But there are exist also other its real compositions based on *only* these variables. We introduce here into consideration four Hermitian forms expressed by means of only these variables

$$\begin{aligned} j_0 &= k\chi\chi^* + (\chi')(\chi'^*)/k, & j_1 &= k\chi\chi^* - (\chi')(\chi'^*)/k, \\ j_2 &= \chi\chi'^* + \chi^*\chi', & j_3 &= i(\chi\chi'^* - \chi^*\chi'), \end{aligned} \quad (10)$$

therefore all four of them satisfy to the identity (2.6) and may also be considered as observables. Taking into account (2.2) and comparing equations (2.5), (2.10) one may see that both quadruples, (2.5) and (2.10), are the same. Therefore both quadruples of j_s may be considered as an observables in the same way as ρ and j_3 mentioned above.

It means that four Hermitian forms j_s form the complete set of observables due to the completeness condition (2.6), only three of them are independent. Besides, the Schroedinger equation (2.1), its spinor representation (2.3) and relations (2.2) allow one to derive equations (2.9), leading not only to conservation law for current j_3 , but also to the consistent variations of the Hermitian forms complete set at the same time.

Let us consider the group-theoretic properties of propagators in the spinor description. The last equation in (2.9), $j'_3 = 0$, means that the real scalar Hermitian form $j_3 = \Phi^+ \sigma_3 \Phi$ is a constant. Let Q is a matrix transforming $\Phi(z_0)$ into $\Phi(z)$, i.e. $\Phi(z) = Q(z, z_0)\Phi(z_0)$. Substituting this expression into the conservation condition $j_3 = \text{const}$ under arbitrary $\Phi(z_0)$, one has the relation

$$Q^+ \sigma_3 Q = \sigma_3, \quad (11)$$

which means that matrix Q belongs to the group $Q \in SU(1, 1)$ (Lontano & Lunin, 1991) with the properties $\det Q = 1$, $Q_{22}^* = Q_{11}$, $Q_{21}^* = Q_{12}$. Of course, this conclusion can also be drawn from the expression for the product integral (2.4), which is a solution to equation (2.3).

The Schroedinger equation describes spatial behavior both free particle and also particle in potential. It defines also all conservation laws for observables at the same time (Malkin & Man'ko, 1979). Therefore it is quiet clear that the ordered sequence of the points where all necessary conservation laws are fulfilled forms the line which may be considered as the particle trajectory. It means that a free particle described with the Schroedinger equation

does not obey to move along Euclidean straight line *under any conditions*, as it takes place in classical mechanics. Although all variables in the Schroedinger equation depend on only z in our case, however conservation laws fulfilment for the Hermitian forms under arbitrary conditions at the initial point may lead to another such line spatial behavior, where all necessary conservation laws are fulfilled, as it would be shown below.

Therefore the first our task is to define the spatial configuration of the line where all exact conservation laws are fulfilled for the free particle under arbitrary conditions at the initial point.

The stationary Schroedinger equation is the second order equation over a set of complex functions. The wave function and its derivative at the initial point have to be set independently, therefore they are defined by four real parameters. Connection of the theory with experiment requires, in particular, to define initial conditions from measurements. It means that these conditions would be expressed as Hermitian forms which are consistent with observables to be measured, and vice versa. The complete set of Hermitian forms contains four ones, and three of them are independent. Therefore two Hermitian forms, ρ and j_3 , which are considered in a generally accepted schemes of quantum mechanics, can not be recognized sufficient for construction of a complete and closed theory.

In an accepted schemes of quantum mechanics the vector $\mathbf{j} = i(\chi\nabla\chi^* - \chi^*\nabla\chi)$ is associated with particle momentum (Landau & Lifshitz, 1963), its amplitude coincides with j_3 in the unidimensional case, therefore we shall also connect j_3 with momentum. It would be expected that all other j_s have a similar sense due to the identity (2.6). One may suppose that an energy is also included in the set of j_s on account of its completeness, but due to the circumstance that the complete set of Hermitian forms includes more variables then it is considered in the accepted forms of quantum mechanics, a connection between energy and momentum here does not coincide with this one in the ordinary schemes of quantum mechanics. They coincide only in the case of $j_1 = j_2 = 0$. It may be shown that a wave function has a form of plane wave under these conditions, j_0 and j_3 are constant everywhere and they have no periodical behavior, although the particle de Broglie wave exists.

An energy and momentum of free particle are reserved both in classical and in quantum mechanics. It is quiet clear that, keeping succession, we have to associate an energy with the Hermitian form j_0 , which is positive defined at the same time, as it seen from (2.5). Such incomplete knowledge on j_s is sufficient for our aim here, explicit its identification is more appropriate under more evident alignment of this scheme and the non-Euclidean superposition principle with special relativity where the group-theoretic requirements are especially important.

All exact differential conservation laws are fulfilled on the line to be defined, and the identity (2.6) is also fulfilled there. Moreover, it is the only law containing all observables, on the one hand, and it is fulfilled independently if these Hermitian forms are constructed on the base of the Schroedinger equation solution or not, on the other hand. A similar significance and structure has only the consequence of the Euclidean metric, which under parametric representation of line $X(t), Y(t), Z(t)$ may be written in form $S'^2(t) = X'^2(t) + Y'^2(t) + Z'^2(t)$, where $S(t)$ is a curve length depending on monotonic parameter t . Requiring consistence of the identity (2.6) with the consequence of the Euclidean metric, we shall accept a following correspondence: $j_0 \sim S', j_1 \sim X', j_2 \sim Y', j_3 \sim Z'$.

Let $X(t), Y(t), Z(t)$ are coordinates of the points where all conservation laws are fulfilled. To define the line which is formed by ordered sequence of these points, one may use the fact that a spatial curve is uniquely defined, up to orientation in space, by its curvature and torsion.

Nonnegative curvature is defined by the first and the second its derivative with respect to parameter, and the torsion depends also on the third derivative (Poznyak & Shikin, 1990). Thus, we obtain a following conclusion on the line where all conservation laws are fulfilled: the quantum particle trajectory is defined uniquely under fulfilling of all exact conservation laws following from the Schroedinger equation excluding its space orientation, i.e. up to insignificant circumstance of a coordinate system choice. If some theory based on such equation does not lead to such trajectory, then it means that the theory does not contain all necessary observables and (or) some conservation laws are violated.

This line is defined by parameters j_s, j'_s, j''_s . If $j_3 = const$ the curvature K_1 and the torsion K_2 are expressed as (Lunin, 2008)

$$K_1 = \frac{\sqrt{j_0^2(j_1'^2 + j_2'^2) - (j_1j_1' + j_2j_2')^2}}{j_0^3}, \quad K_2 = \frac{j_3(j_1'j_2'' - j_2'j_1'')}{j_0^2(j_1'^2 + j_2'^2) - (j_1j_1' + j_2j_2')^2}. \quad (12)$$

The group-theoretic properties of transformations under quantum particle motion most clearly appear in the spinor representation of the Schroedinger equation (2.3). Taking a spinor in its most general form we have

$$\Phi = \left\| \begin{matrix} ae^{i\alpha} \\ be^{i\beta} \end{matrix} \right\| = e^{i\frac{(\beta+\alpha)}{2}} \left\| \begin{matrix} ae^{-i\frac{(\beta-\alpha)}{2}} \\ be^{i\frac{(\beta-\alpha)}{2}} \end{matrix} \right\| \quad (13)$$

with its Hermitian forms

$$\begin{aligned} j_0 &= a^2 + b^2, \quad j_1 = 2ab \cos(\beta - \alpha), \\ j_3 &= a^2 - b^2, \quad j_2 = 2ab \sin(\beta - \alpha). \end{aligned} \quad (14)$$

It is quite clear that they are defined by three independent real parameters $a, b, (\beta - \alpha)$ and satisfy to the identity (2.6). Relations (2.13), (2.14) and (2.2) allow one to express χ, χ' , and also Φ_{\pm} by means of j_s .

If the parameter k^2 in (2.1) is constant, $k'(z) = 0$, the term $(k'/2k)\sigma_1$ in (2.4) is vanished together with non-commutativity, and $Q(z, z_0) = \exp[ik(z - z_0)\sigma_3]$. Then the propagator Q satisfies to $Q^+\sigma_0Q = \sigma_0$ which means conservation j_0 in addition to j_3 . As far as $Q^+ = Q^{-1}$, then Q belongs to the unitary commutative subgroup of the group $SU(1, 1)$.

It is clear from equations (2.14) that a and b are constant for the free particle, then spinor components under arbitrary conditions at z_0 may be written at any point z as

$$\Phi_+ = a_0 e^{i[k(z-z_0) - \frac{\beta_0 - \alpha_0}{2}]}, \quad \Phi_- = b_0 e^{-i[k(z-z_0) - \frac{\beta_0 - \alpha_0}{2}]}, \quad (15)$$

therefore one has free particle observables under correspondent parameters at the z_0

$$\begin{aligned} j_0 &= a_0^2 + b_0^2, \quad j_1 = 2a_0b_0 \cos[2kz - (\beta_0 - \alpha_0)], \\ j_3 &= a_0^2 - b_0^2, \quad j_2 = 2a_0b_0 \sin[2kz - (\beta_0 - \alpha_0)]. \end{aligned} \quad (16)$$

The expressions for K_1 and K_2 are simpler in this case

$$K_1 = \frac{\sqrt{j_1'^2 + j_2'^2}}{j_0^2}, \quad K_2 = \frac{j_3(j_1'j_2'' - j_2'j_1'')}{j_0^2(j_1'^2 + j_2'^2)}. \quad (17)$$

Taking into account equations (2.16) and (2.17) under condition $k(z) = const$ one may see that $K_1(z)$ and $K_2(z)$ satisfy to the following conditions

$$\begin{aligned} K_1(z) &= 2k \frac{\sqrt{j_1^2(z) + j_2^2(z)}}{j_0^2(z)} = 2k \frac{\sqrt{j_1^2(0) + j_2^2(0)}}{j_0^2(0)} = const, \\ K_2(z) &= -2k \frac{j_3(z)}{j_0^2(z)} = -2k \frac{j_3(0)}{j_0^2(0)} = const. \end{aligned} \quad (18)$$

Thus, both the curvature and the torsion of *free* quantum particle are constant and, being dependent on j_s at the initial point, may have arbitrary values. Only the spiral lines have such properties. If $K_1 = 0$, i.e. $j_1^2 + j_2^2 = 0$, then trajectory is the straight line; if $K_2 = 0$, i.e. $j_3 = 0$, then it is situated at the plane, and $K_1 = 2k/j_0$. The sign minus in K_2 means that the spinor components (2.15) and its observables correspond to the left-hand spiral line. The action of the inversion operator σ_1 (Lunin, 2002), i.e. permutation of the spinor components, change the torsion sign, and the left spiral line converts into the right one.

Integrating the expressions (2.16) under corresponding constants choice, then excluding integration variable z and go over to the particle Z -coordinate, we have the following expressions for particle coordinates and its path length

$$\begin{aligned} X(Z) &= -\frac{\sqrt{j_1^2(0) + j_2^2(0)}}{2k} \cos[2(k/j_3(0))Z + \arctan(j_1(0)/j_2(0))], \\ Y(Z) &= \frac{\sqrt{j_1^2(0) + j_2^2(0)}}{2k} \sin[2(k/j_3(0))Z + \arctan(j_1(0)/j_2(0))], \\ Z &= Z, \quad S(Z) = [j_0(0)/j_3(0)]Z. \end{aligned} \quad (19)$$

Let us consider the main peculiarities of free-particle trajectories. The requirement $2(k/j_3(0))Z_{st} = 2\pi$ defines the spiral line step Z_{st} . The first two expressions in (2.19) lead to its radius R : $Z^2 + Y^2 = [j_1^2(0) + j_2^2(0)]/(4k^2) \equiv R^2 = const$. Particle path length along one step is $S_{st} = \pi j_0(0)/k$. Going over to the de Broglie wavelength $\lambda = 2\pi/k$ the trajectory parameters may be expressed as (Lunin, 2008)

$$Z_{st} = [j_3(0)/2]\lambda, \quad R = \frac{\sqrt{j_1^2(0) + j_2^2(0)}}{4\pi} \lambda, \quad S_{st} = [j_0(0)/2]\lambda. \quad (20)$$

It is seen from equations (2.20) that the free quantum particle described with the Schroedinger equation contains also a transverse components of its motion depending on the de Broglie wavelength. All components of such motion are proportional to this wavelength but they are also dependent upon the observables j_s at the initial point. The last circumstance leads, for example, to the same S_{st} under different combinations of $j_s(0)$.

Let notice that variable k entered the Schroedinger equation and defining the de Broglie wavelength may be expressed as $k(z) = -j_2'(z)/(2j_1(z))$ due to equations (2.9). Unrolling surface of the cylinder onto a plane and applying the Pythagorean theorem to the triangle formed by legs Z_{st} and $2\pi R$, and hypotenuse S_{st} , one obtains the equality $Z_{st}^2 + (2\pi R)^2 = S_{st}^2$, which leads to the identity (2.6) due to the conditions (2.20). The angle between an element of the cylinder directed along the axis Z and the tangent to the spiral line is determined by $\tan \theta = (2\pi R)/Z_{st} = \sqrt{j_1^2 + j_2^2}/j_3$. It coincides with the ratio of the curvature of the spiral line to its torsion.

Potential variations lead, according to equations (2.9), to variations of j_0, j_1, j_2 , they change, in turn, the curvature and the torsion, i.e. trajectory. Let the particle beginning motion at $z = 0$ under arbitrary conditions, moves in area $0 \leq z \leq a$ under $k_1 = const$, then passing

through the potential step at $z = a$ k_1 goes to $k_2 = const$. The propagator expression calculated according (2.4) (Kolkunov, 1969; 1970) is expressed in this case as

$$Q(z, 0) = \exp(iM\sigma_3) \exp(L\sigma_1) \exp(iN\sigma_3), \tag{21}$$

where $N = k_1 a, M = k_2(z - a), L = (1/2) \ln(k_2/k_1)$ are real parameters. At both sides of the step the particle trajectories are spiral lines with different parameters. Therefore, since only transformation of motion is interesting in this case, let us put $N = M = 0$ in (2.21), then $Q = \exp(L\sigma_1)$ and $Q^+ = Q$. Such matrix satisfies to conditions $Q^+\sigma_2Q = \sigma_2$ and $Q^+\sigma_3Q = \sigma_3$, i.e. j_2 and j_3 are conserved. One has the following transformations in this case

$$J_0 = \cosh(2L)j_0 + \sinh(2L)j_1, \quad J_1 = \sinh(2L)j_0 + \cosh(2L)j_1, \quad J_2 = j_2, \quad J_3 = j_3, \tag{22}$$

then

$$\begin{aligned} Z_{st}(k_2) &= \pi J_3/k_2 = \pi j_3/k_2, \\ R(k_2) &= \frac{\sqrt{j_1^2 + j_2^2}}{2k_2} = \frac{\sqrt{j_1^2 + j_2^2 + \sinh(4L)j_0j_1 + \sinh^2(2L)(j_0^2 + j_1^2)}}{2k_2}, \\ S_{st}(k_2) &= \pi J_0/k_2 = \pi[\cosh(2L)j_0 + \sinh(2L)j_1]/k_2. \end{aligned} \tag{23}$$

It is seen from expressions (2.23) that there are exist conditions dependent on the value L leading to $R = 0$. It means that, as far as an arbitrary element of the group $SU(1, 1)$ is representable in the form (2.21), it is possible a transformation of the spiral particle trajectory with $R \neq 0$ into the Newtonian free particle trajectory, and vice versa.

Similar consideration of particle motion above right angle potential barrier shows that there are exist conditions under which all j_s in front of the barrier go to the same behind it (Lunin, 2008). These conditions coincide with the same ones when the reflection coefficient is zero in the ordinary forms of quantum mechanics.

Let us notice here a similarity of transformations (2.22) to those in the special relativity.

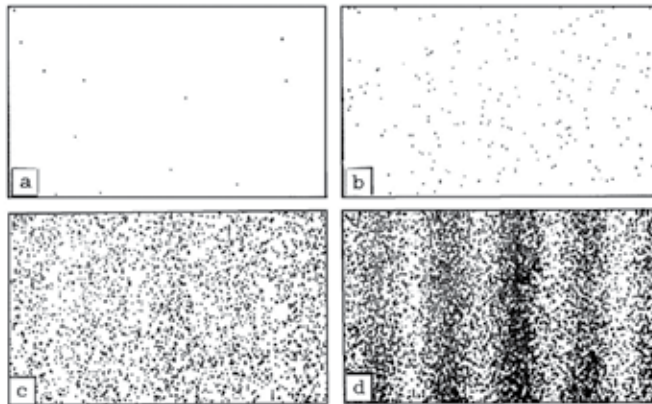

Fig. 1. Double-slit experiment with a low-intensity source of electrons under different expositions (Tonomura et al., 1989).

Free particle spiral-like trajectories allow one to propose a qualitative explanation of the double-slit experiment with single electrons which does not require a particle dualism and a wave function collapse (Kadomtzev, 2003). Figure 1 shows the results of the double-slit experiment (Tonomura et al., 1989) under individual electrons when the next particle leaves

the source after the previous one has already been registered and disappeared. It is seen two peculiarities there. The first and the main one is the fact that each electron produces only one point-wise trace, and the second one is the periodic spatial distribution of the traces density appearing only under enough long expositions.

As it is shown above the question on completeness of observables is not solved both in the theory and in the experiment. Therefore it is necessary to make some assumptions, especially on the free particle transverse motion, i.e. on j_1 and j_2 (Lunin, 2008).

Let us assume that $j_1^2 + j_2^2 \neq 0$ are equal for all particles, i.e. their R are also the same. However j_1 and j_2 may be different at the same time, and we assume that they have random values. Figure 2 shows results of simulation for the experiment under this assumption.

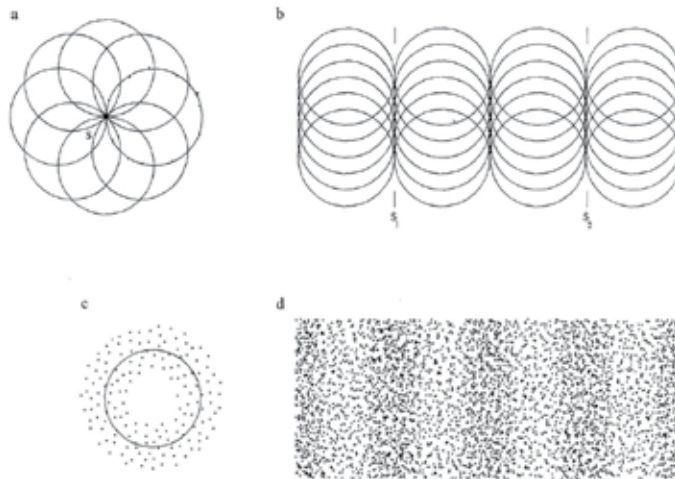

Fig. 2. Simulation of the double-slit experiment for particles moving along helical lines.

There are shown some circles in figure 2a which are cross sections of the cylinder surfaces where spiral trajectories are situated. The points on one of them show a random positions of different particles, and only those of particles form a traces on the photographic plate which go through the point-wise slit S . Therefore *one circle* leads to *one trace*, and another circle leads to another trace and so on, but all of them will create increased traces density near the circumscribed circle of all previous circles.

It may be said that the isolated spiral lines set one-to-one mapping the point-wise source (or slit) to the points of the detector plane. This circumstance explain the point-wise traces on the photographic plate.

The stretched slit is the set of point-wise ones. Figure 2b shows two slits S_1 , S_2 and a set of corresponding circles described above under the assumption that the distance between slits is close to twice diameter of the spiral curve. Let us note that the particles having velocity projections almost parallel to the slits direction go through the slits in relatively more number then those having perpendicular projections.

Comparing the simulation with the experiment one would take into account the main experimental factors: a particles source dimensions and angle distribution of particles velocities. These factors lead to smoothing of the interference-like picture but they can not lead to disappearance of *point-like* traces, see fig.2c.

Combining the simulation results shown in fig. 2b and fig.2c one will get the fig.2d, then comparing it with the experimental ones in fig.1, one may see a qualitative similarity of them. It is necessary to emphasize once more that this result has only qualitative character.

Combining in turn fig.2a and fig.2c it may be also explained the old experiment on the scattering of individual electrons on the hole (Biberman et al., 1949), also only qualitatively, of course.

It may be said that the systems of small holes or slits are the particles transverse motion analyzers, good or bad.

3. Non-Euclidean superposition principle

This subject should be considered to be the key question for the group-theoretic structure of quantum mechanics. Keeping in mind the Feynman scheme, we shall attempt to develop a similar construction, however taking into account the group-theoretic requirements for non-commutative propagators, and observables j_s complete set which are arbitrary at the initial point of particle motion.

Let the particle is described by the Schroedinger equation $\nabla^2\chi(\mathbf{r}) + k^2(\mathbf{r})\chi(\mathbf{r}) = 0$. In the case of spatial dependent potential, let us connect an initial and final points \mathbf{r}_i and \mathbf{r}_f with arbitrary piecewise smooth line n defined by tangent unit vector $\mathbf{u}_n(\mathbf{r})$ with initial and final ones \mathbf{u}_i and \mathbf{u}_f . Projecting all vector variables onto this line and keeping in mind an infinite set of unidimensional equations along such paths, one has the following form of the product integral along n -th path

$$Q_n(\mathbf{r}_f, \mathbf{u}_f; \mathbf{r}_i, \mathbf{u}_i) = T \exp \int_{\mathbf{r}_i}^{\mathbf{r}_f} [i(\mathbf{k}\mathbf{u}_n)\sigma_3 + \frac{(\mathbf{u}_n\nabla k)}{2k}\sigma_1] dl, \quad (24)$$

where all variables depend on path length l . We shall call it as n -th partial propagator, it has the same group-theoretic properties as (2.4), i.e. matrices Q_n belong to the same non-commutative group $SU(1,1)$ (Lunin, 2002).

To construct the complete propagator taking all paths into account, it is necessary to find at least the composition of two such non-commutative matrices, which belongs to the same multiplicative group and unchanging under these matrices permutation. Let us define a metric of the propagators logarithms space (Lunin, 2002). As far as the product integrals in (2.4) and (3.1) have the same structure and therefore they define the same groups, we shall use for simplicity the first one. Considering integrand in (2.4) as vector in of the space to be defined in orthogonal basis σ_s (Casanova, 1976), one makes up the first quadratic form as $ds^2 = -k^2 dz^2 + dk^2/(4k^2)$. This expression defines the plane (k, z) with the Gaussian curvature $C_G = -4$, i.e. the Lobachevsky plane. Going over to variables $u = 1/(2ik)$, $v = z$, one gets the integrand ds and the Kleinian metric form of this plane ds^2 with the same Gaussian curvature

$$ds = \frac{dv\sigma_3 - du\sigma_1}{2u}, \quad ds^2 = \frac{du^2 + dv^2}{4u^2}. \quad (25)$$

As far as equations of kind (2.1) describe a number of physical phenomena, let us investigate the significance of this curvature value. If we multiply (2.3) by dz and go over to variables u, v , we get the expression $d\Phi = [(dv\sigma_3 - du\sigma_1)/(2u)]\Phi$, where the integer 2 defines $C_G = -4$. Let replace this integer by an arbitrary constant R and return to variables k, z . Then one has an equation $(R/2)\Phi' = [ik\sigma_3 + k'/(2k)\sigma_1]\Phi$ instead of (2.3). Taking (2.2) into account under

conservation R and returning to equation for χ , we have

$$\chi'' + k^2(z)\chi + \left(\frac{2}{R} - 1\right)\left[\left(ik + \frac{k'}{2k}\right)\chi' + ik\left(-ik + \frac{k'}{2k}\right)\chi\right] = 0.$$

It is quiet clear that the last equation goes over to (2.1) only under $R = 2$. As far as a great number of physical phenomena obey to the equations of the spatial stationary Schroedinger equation kind, so as the Helmholtz one, and the Gaussian curvature $C_G = -4$ is its consequence, this curvature value has the exceptional role compared with the role of such kind equations.

Having determined the propagators logarithms space, or the space of the Lie algebra of the group $SU(1,1)$, which is the Lobachevsky plane, it is needed to map the group into this space. It is necessary for it to map the group elements there as the geometrical objects, and to find the operation under these objects corresponding to the group operation.

The metric in (3.2) maps the hyperbolic plane onto the upper Euclidean half-plane $u > 0$ as the conformal mapping in semi-geodesic orthogonal coordinate system (the Poincare map) (Bukreev, 1951). Any group element from $SU(1,1)$ may be expressed in form (2.21), and also as $Q = \exp(\mathbf{a}\sigma)$, then one has the following equality

$$Q = e^{iM\sigma_3} e^{L\sigma_1} e^{iN\sigma_3} = e^{\mathbf{a}\sigma} = \cosh a + (\mathbf{a}\sigma)(\sinh a/a), \quad (26)$$

where $(\mathbf{a}\sigma) = a_1\sigma_1 + a_2\sigma_2 + a_3\sigma_3$, $a^2 = a_1^2 + a_2^2 + a_3^2$ with real a_1, a_2 and imaginary a_3 , $\mathbf{a} = \mathbf{n}_a a$. It should be noted that the geodesic lines (straight lines) on the Lobachevsky plane in its representation on the Poincare map are the semicircles with its centers on the horizontal axis v (see figure 3 below) and euclidean straight lines parallel to axis u . Following to (Lunin, 1994; 1998; 2002), taking an arbitrary point on the Poincare map as initial one, let us map the matrix $\exp(iN\sigma_3)$ as the oriented segment with length N along any geodesic line outgoing from the initial point. Note that the geodesic vector length a is defined by the matrix trace, as it follows from (3.3). Then we map the matrix $\exp(L\sigma_1)$ as the next geodesic segment with the initial point at the end of previous segment and length L along the perpendicular geodesic line. The matrix $\exp(iM\sigma_3)$ is mapped in the similar way.

Let us connect the initial point and the end of the last segment with the geodesic line on the Poincare map. Then we shall obtain the plane figure named as *bi-rectangle*, the fourth its side corresponds to the geodesic vector \mathbf{a} in (3.3). Equalities for matrix elements in (3.3) allow one to obtain all elements of the bi-rectangles or triangles (if N or M is equal to zero).

Thus, the group $SU(1,1)$ element is mapped as the oriented segment of the geodesic line, or geodesic vector, on the Poincare map. It is quite clear that the successive addition of the geodesic vectors corresponds to the group operation of successive matrices multiplication at the same time. This circumstance explains also the sense of the term "propagator logarithms space" used above.

To make more clear the geometric sense of the group operation, let us multiply two arbitrary matrices:

$$\exp(\mathbf{c}\sigma) = \exp(\mathbf{b}\sigma) \exp(\mathbf{a}\sigma) = \cosh b \cosh a + (\mathbf{n}_b \mathbf{n}_a) \sinh b \sinh a + \sigma \{ \mathbf{n}_b \sinh b \cosh a + \mathbf{n}_a \sinh a \cosh b + i[\mathbf{n}_b \mathbf{n}_a] \sinh b \sinh a \}. \quad (27)$$

One may see from (3.4) that the resulting geodesic vector \mathbf{c} contains the orthogonal component to the plane defined by vectors \mathbf{a} and \mathbf{b} , and its length c may be obtained from the expression $\cosh c = \cosh b \cosh a + (\mathbf{n}_b \mathbf{n}_a) \sinh b \sinh a$. The non-commutativity of the matrices $\exp(\mathbf{a}\sigma)$

and $\exp(b\sigma)$ is defined by this orthogonal component. It is also seen that the geodesic vectors of the commutative matrices are situated on the same geodesic line due to $[n_b, n_a] = 0$. These facts make clear the geometric sense of non-commutativity. Let us note here that the group $SU(1, 1)$ logarithms space involves the complete three-dimensional Lobachevsky space. It may be said that the multiplicative non-commutative three-parameter group $SU(1, 1)$ is isomorphically represented as additive group in the Lobachevsky space with the constant negative Gaussian curvature being similar to the map of the group $SU(2)$ on the unit sphere. Let us find the binary commutative composition over the non-commutative group $SU(1, 1)$. Let the matrix Q_M is the result of the composition to be find of two arbitrary equivalent non-commutative matrices Q_A and Q_B . Let us formulate the requirements for Q_M :

- a) $Q_M \in SU(1, 1)$;
- b) $Q_M \rightarrow Q_A$, if $Q_B \rightarrow 1$ and $Q_M \rightarrow Q_B$, if $Q_A \rightarrow 1$;
- c) $Q_M \rightarrow Q_M$, if $Q_A \rightarrow Q_B$ and $Q_B \rightarrow Q_A$.

In accordance with (a) all these matrices are representable as $Q_A = \exp(a\sigma)$, $Q_B = \exp(b\sigma)$, $Q_M = \exp(m\sigma)$. All geodesic vectors have the common initial point O on the Poincare map due to (b), see figure 3.

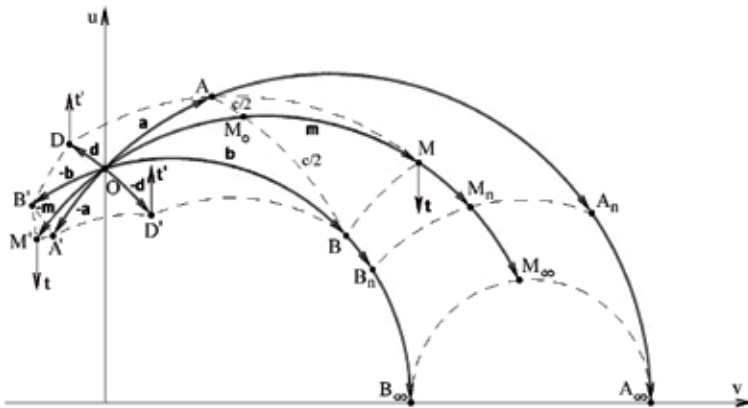

Fig. 3. The Poincare map. Geodesic lines are semicircles with centers on v-axis.

The requirement in (c) would be fulfilled if the vector m goes through the hyperbolic middle M_0 of the oriented segment $AB = c$ connecting the ends of vectors a and b there. Our task now is to obtain the geodesic vector m , finding at first the triangle OAB median OM_0 outgoing from the initial point O . Taking into account that m and c intersect in their midpoints M_0 , one has the following relations for triangles OAB , OAM_0 , and OM_0B respectively:

$$\begin{aligned} \exp(c\sigma) \exp(a\sigma) &= \exp(b\sigma), \\ \exp(c\sigma/2) \exp(a\sigma) &= \exp(m\sigma/2), \\ \exp(c\sigma/2) \exp(m\sigma/2) &= \exp(b\sigma). \end{aligned}$$

These relations lead to the expression to be find

$$\begin{aligned} \exp(m\sigma) &= \{[\exp(a\sigma) \exp(-b\sigma)]^{1/2} \exp(b\sigma)\}^2 = \\ &= \{[\exp(b\sigma) \exp(-a\sigma)]^{1/2} \exp(a\sigma)\}^2. \end{aligned} \tag{28}$$

Obviously that $\exp(\mathbf{m}\sigma) = \exp(\mathbf{b}\sigma)$ if $\mathbf{a} = 0$ and $\exp(\mathbf{m}\sigma) = \exp(\mathbf{a}\sigma)$ if $\mathbf{b} = 0$. Since the products and their real powers do not change the group belonging, then the matrix $\exp(\mathbf{m}\sigma)$ also belongs to the same group as both $\exp(\mathbf{a}\sigma)$ and $\exp(\mathbf{b}\sigma)$. Therefore the expressions (3.5) set the commutative binary composition over non-Abelian group $SU(1,1)$. If $\exp(\mathbf{a}\sigma)$ and $\exp(\mathbf{b}\sigma)$ are commutative then $\mathbf{m} \equiv \mathbf{a} + \mathbf{b}$. As long as the group $SU(1,1)$ is the topological one, then one can expand (3.5) into series under conditions of small \mathbf{a} and \mathbf{b} , \mathbf{m} is also small in this case. Taking into account the smallness second order, one has $\mathbf{m} \cong \mathbf{a} + \mathbf{b}$ and, independently, $m^2 \cong a^2 + b^2 + 2(\mathbf{a}\mathbf{b})$. Therefore the composition rule (3.5) goes to the ordinary superposition principle up to the smallness second order. Representing the geodesic vectors as $\mathbf{a} = n_a a$ and so on, we have the following expressions for the vector \mathbf{m} :

$$n_m = \frac{n_a \sinh a + n_b \sinh b}{p}, \quad \tanh(m/2) = \frac{p}{\cosh a + \cosh b'} \tag{29}$$

where $p^2 = \sinh^2 a + 2(n_a n_b) \sinh a \sinh b + \sinh^2 b$.

The composition rule (3.5) may be extended up to the square nonsingular matrices of any order and also up to an arbitrary Lie groups under condition of existence their matrix representations:

$$M = \{[AB^{-1}]^{1/2}B\}^2 = \{[BA^{-1}]^{1/2}A\}^2.$$

Extremely important role belongs to the discrete symmetries in physics, especially in quantum mechanics. Beforehand we mean here the inversion and permutations. Such symmetries become geometrically apparent and contain particularly rich capabilities in the binary compositions of the propagators.

It is clear that $\mathbf{a} \rightarrow -\mathbf{a}$ leads to $Q_A \rightarrow Q_A^{-1}$. Let us consider the geometric properties of the binary composition (3.5) on the Poincare map, figure 3. If O is the common point of both geodesic vectors \mathbf{a} and \mathbf{b} , then \mathbf{m} is the diagonal of the Lobachevsky parallelogram $OAMB$. Let us prolong the corresponding geodesic lines to the left hand of the point O , then we shall get vectors $-\mathbf{a}$ and $-\mathbf{b}$, they define the inverse matrices Q_A^{-1} and Q_B^{-1} . The vector $-\mathbf{m}$ corresponds to the inversed parallelogram $OA'M'B'$ diagonal OM' , then one has the inversed composition $M^{-1} = \{[A^{-1}B]^{1/2}B^{-1}\}^2$. Analogically, if one replaces only one vector \mathbf{b} by $-\mathbf{b}$, then we shall have the parallelogram $OADB'$ with its diagonal \mathbf{d} . It leads to the composition $D = \{[AB]^{1/2}B^{-1}\}^2$, which goes also to the inverse one under inversion both A and B . If vectors \mathbf{a} and \mathbf{b} are small then $\mathbf{d} \cong \mathbf{a} - \mathbf{b}$. Let us emphasize that all vectors $\mathbf{a}, \mathbf{b}, \mathbf{m}$, and \mathbf{d} (see fig.3) are situated on the same Lobachevsky plane, all of them do not contain an orthogonal components to their Lobachevsky plane. It is quit clear from fig.3 that permutation of the vectors \mathbf{a} and \mathbf{b} leads to $\mathbf{d} \rightarrow -\mathbf{d}$. In the matrix terms it means that $D \rightarrow D^{-1}$ under permutation of A and B .

We have investigated all discrete symmetries mentioned above which may be represented in the Lobachevsky plane. However it is not the complete investigation of the geometric properties of the $SU(1,1)$ group in the complete Lobachevsky space, it is necessary to go outside of the Lobachevsky plane to obtain the complete geometric description of non-commutativity.

For this aim it is necessary to obtain the composition which includes only the term proportional to the $[n_b n_a]$ in its exponential expression, as it is clear from the expression (3.4). Omitting cumbersome geometric tracings and also cumbersome algebraic calculations, we shall bring the results. The composition to be defined has two forms: $T = (AB^{-2}A)^{1/2}A^{-1}B$ and $T' = (AB^2A)^{1/2}A^{-1}B^{-1}$ (here prime means only notation, without any other sense). Let

we find the geometric sense of the composition T . Representing all matrices in exponential form one obtains

$$T = \exp(\mathbf{t}\sigma) = \cosh t + (\mathbf{n}_t\sigma) \sinh t = (e^{a\sigma} e^{-2b\sigma} e^{a\sigma})^{1/2} e^{-a\sigma} e^{b\sigma},$$

then the parameters of the vector \mathbf{t} are expressed as (Lunin & Kogan, 2004; 2009)

$$\mathbf{n}_t = i \frac{[\mathbf{n}_b\mathbf{n}_a]}{\sqrt{1 - (\mathbf{n}_b\mathbf{n}_a)^2}}, \quad \tanh t = \frac{\sqrt{1 - (\mathbf{n}_b\mathbf{n}_a)^2} \tanh b \tanh a}{1 - (\mathbf{n}_b\mathbf{n}_a) \tanh b \tanh a}. \quad (30)$$

It is seen from formulae (3.7) that vector \mathbf{n}_t is orthogonal to the plane of both vectors \mathbf{a} and \mathbf{b} , and \mathbf{t} is equal to zero if they are collinear, i.e. T is the identity matrix under A and B commutativity. One has to imagine the vectors \mathbf{t} and \mathbf{t}' to be perpendicular to the Lobachevsky plane of the vectors \mathbf{a} and \mathbf{b} , i.e. to the Poincare map in this case, figure 3. The geodesic vectors \mathbf{a} and \mathbf{b} form the triangle on the Lobachevsky plane. Taking into account the Cagnoli formula expressing the triangle area via its two sides and the angle between them and comparing it with (3.7), one may see that \mathbf{t} defines oriented parallelogram $OAMB$ area. Of course, there are exist connections between an area value and angle defect δ : $\tanh t = \sin \delta$, the vector \mathbf{t} is also connected with the Berry phase. If \mathbf{a} and \mathbf{b} are small then $\mathbf{t} \cong i[\mathbf{b}\mathbf{a}] \cong -\mathbf{t}'$, i.e. parallelograms areas are the same.

Let us investigate the properties of compositions T and T' with respect to the discrete symmetries. It is seen from (3.7) that permutation of matrices A and B leads to $\mathbf{n}_t \rightarrow -\mathbf{n}_t$, i.e. to $T \rightarrow T^{-1}$. If we shall replace both vectors $\mathbf{a} \rightarrow -\mathbf{a}$ and $\mathbf{b} \rightarrow -\mathbf{b}$, then both expressions in (3.7) would not be changed. Geometrically these replacements lead to the transformation of the parallelogram $OAMB$ into one $OA'M'B'$, fig.3, with the same orientation and area, i.e. $T \rightarrow T$.

The replacement of only one vector $\mathbf{b} \rightarrow -\mathbf{b}$ leads to the parallelogram $OADB'$ with contrary directed unit vector \mathbf{n}_t and with changed area value. Note that this replacement transforms $T \rightarrow T'$ at the same time, then T and T' have the similar symmetry properties, of course.

Opposite directions of \mathbf{n}_t and $\mathbf{n}_{t'}$ for adjacent areas express the saddle character of the planes with negative Gaussian curvature.

One may see that addition of the binary compositions T and T' to M and D extends the geometry contents of the binary compositions over the group $SU(1,1)$ up to the complete three-dimensional Lobachevsky space.

The symmetry properties of all binary compositions obtained above in the geometric way may be also verified by means of the ordinary algebraic calculations (Lunin, 2002; Lunin & Kogan, 2009).

All the binary compositions mentioned above may be considered as the *non-Euclidean superposition principle*:

$$\begin{aligned} M &= \{[AB^{-1}]^{1/2}B\}^2 = \{[BA^{-1}]^{1/2}A\}^2, \\ D &= \{[AB]^{1/2}B^{-1}\}^2, \\ T &= [AB^{-2}A]^{1/2}A^{-1}B, \quad T' = [AB^2A]^{1/2}A^{-1}B^{-1}, \end{aligned} \quad (31)$$

applicable to the multiplicative non-Abelian Lie groups of any order. All these compositions belong to the same groups as both A and B , since real powers do not change the group belonging. These compositions have the following properties with respect to the discrete symmetries under non-commutative group elements A and B

$$\text{if } A \rightarrow B, \quad B \rightarrow A, \quad \text{then } M \rightarrow M, \quad D \rightarrow D^{-1}, \quad T \rightarrow T^{-1}, \quad T' \rightarrow (T')^{-1};$$

if $A \rightarrow A^{-1}$, $B \rightarrow B^{-1}$, *then* $M \rightarrow M^{-1}$, $D \rightarrow D^{-1}$, $T \rightarrow T$, $T' \rightarrow T'$.

These compositions go over to the ordinary superposition principle in the vicinity of identity with the same symmetry properties. The group elements A and B may also belong to the commutative group, the compositions M and D conserve their symmetry properties, both T and T' are the identity in this case. The last circumstance allowed one to consider the compositions T and T' as the commutators over the multiplicative groups.

In the simple cases of some subgroups of the group $SL(2, C)$, such as $SU(2)$, $SU(1, 1)$, the non-Euclidean superposition principle has the geometric interpretation in the spaces with nonzero Gaussian curvature. Such groups may be mapped as additive groups into such spaces with quit clear geometric sense of the group elements, the operation over the group, and the compositions discussed above.

It is extremely important to compare the ordinary superposition principle used in a great number of physical phenomena up to now, and the non-Euclidean superposition principle. We shall consider the double-slit experiment for this aim.

At first, it is needed to consider the factors which may be different or the same in the ordinary consideration and proposed here. These factors may be separated with respect to the experimental and also theoretical ones.

If we are interesting now only to compare two composition rules, we have to set the same experimental conditions, and to take the common initial theoretical principles, where it is possible.

From the experimental view point, we regard that stretched slits, as it is usually supposed, lead to loss of subject clarity. It is clear that different pairs of points along stretched slits, one or both, may bring any phase shifts at any detector surface fixed points, and this circumstance has to be taken into account. The last one is not included into the ordinary calculations, it is carried out only for individual path pairs (Feynman & Hibbs, 1965). Therefore we shall consider only two point-wise slits here.

The double-slit experiment is supposed to involve all enigmas of quantum mechanics (Feynman, 1965). However, the ordinary consideration of the experiment does not contain the propagators non-commutativity, as a rule. As long as this circumstance is one of the fundamental peculiarity of quantum mechanics, we shall include this one locating two point-wise slits onto the two media boundary, then the non-commutativity will appear immediately. Nevertheless, excluding the boundary in the final expressions one may compare the composition rules under the same conditions.

Relating to the theoretical distinctions it is necessary to take into account a number of factors. They are following: the Hermitian forms to be compared in the framework of only theory under its incompleteness in the ordinary schemes; the observables have to be compared with the experimental results; the scalar or matrix expressions of the propagators in both approaches; and, of course, the composition rules itself, which have to be roughly consistent with respect to some limiting cases.

Since it is senseless to compare some part of unknown Hermitian forms set with the complete one, we shall accept the complete set in both cases.

It is accepted in the ordinary schemes of quantum mechanics to demonstrate only one observable, the "probability density" $\rho = \chi\chi^* = (j_0 + j_1)/(2k)$, with interference pattern. We regard restriction with only one observable to be insufficient due to reasons discussed in the second part of the paper, therefore we shall include all observables into consideration.

The scalar character of the propagators in the ordinary schemes, for example in the Feynman one, we suppose also to be insufficient, then we are forced to use the matrix one.

The last factor we shall discuss below.

Taking all these assumptions into account, let us consider the double-slit experiment when two point-like slits are arranged at the two media boundary (Lunin, 1998; 2002). The propagators along different paths may be written, in accord with the expression (2.21), as

$$\begin{aligned} A &= \exp(\mathbf{a}\boldsymbol{\sigma}) = \exp(iM_A\sigma_3) \exp(L\sigma_1) \exp(iN_A\sigma_3), \\ B &= \exp(\mathbf{b}\boldsymbol{\sigma}) = \exp(iM_B\sigma_3) \exp(L\sigma_1) \exp(iN_B\sigma_3), \end{aligned} \quad (32)$$

where $N_A = k_1 s_A$, $N_B = k_1 s_B$, $M_A = k_2 r_A$, $M_B = k_2 r_B$, $L = (1/2) \ln(k_2/k_1)$, k_1 and k_2 are reciprocals of waves before and behind slits respectively, s_A and s_B are path lengths from the source up to slits under k_1 , r_A and r_B are the same from slits up to the common point of the detector surface under k_2 .

Now let us consider the last factor mentioned above. It is quit clear that one needs at first to compare the composition M from (3.8) and the sum of A and B . Let us note that the coincidence of two point-wise slits, i.e. shift one of them to the position of another, and shutting down one of them have to lead to the same propagator. On the one hand, if we shall displace the slit B to the position of A we shall have the propagator $M_A = \exp(2\mathbf{a}\boldsymbol{\sigma})$ in the case of the non-Euclidean superposition principle. Under the Euclidean one, using the sum of propagators, one has $2\exp(\mathbf{a}\boldsymbol{\sigma})$, and these matrices have different determinants. On the other hand, if we shut down the slit B , both propagators would be the same, $\exp(\mathbf{a}\boldsymbol{\sigma})$. The geometric investigation of this subject (we have no place to prove it here, see (Lunin, 1994)) shows that the composition of propagators would be the first order hyperbolic moment on the Lobachevsky plane, or the geometric mean, in this and similar cases. It means that the non-Euclidean complete propagator M_{NE} for double-slit experiment has to be taken as $[AB^{-1}]^{1/2}B$ with the same group-theoretic properties. The Euclidean one M_E would be the arithmetic mean at the same time, $(A + B)/2$. Now both propagators are roughly to be consistent in the double slit experiment, besides the group-theoretic requirements, of course. Omitting some calculation details, we shall bring the following expressions for them

$$\begin{aligned} M_{NE} &= \frac{1}{2} \cdot \frac{e^{iM_A\sigma_3} e^{L\sigma_1} e^{iN_A\sigma_3} + e^{iM_B\sigma_3} e^{L\sigma_1} e^{iN_B\sigma_3}}{\sqrt{\cos^2 \frac{(N_1 - N_2) + (M_1 - M_2)}{2} - \sinh^2 L \sin(N_1 - N_2) \sin(M_1 - M_2)}}, \\ M_E &= \frac{e^{iM_A\sigma_3} e^{L\sigma_1} e^{iN_A\sigma_3} + e^{iM_B\sigma_3} e^{L\sigma_1} e^{iN_B\sigma_3}}{2}. \end{aligned}$$

Since matrices in the numerators of both expressions are the same, and since the observables are the bilinear Hermitian forms, all observables calculated by means of two composition rules are distinguished only by factor depending on the problem parameters. Then we have

$$j_s(E) = [\cos^2 \frac{(N_1 - N_2) + (M_1 - M_2)}{2} - \sinh^2 L \sin(N_1 - N_2) \sin(M_1 - M_2)] j_s(NE).$$

As far as $j_3(NE)$ is constant everywhere due to fulfilment of the group-theoretic requirements to the composition M from (3.8), then $j_3(E) \neq const$, in particular it depends on coordinates as it is seen from the expression above. It means that the Euclidean superposition principle leads to violation of some conservation laws excluding the points where expression in brackets is equal to unit.

We note here that the calculation of the interference pattern for more number of point-wise slits requires to obtain the hyperbolic first order moment over corresponding number of

non-collinear geodesic vectors on the Lobachevsky plane. For example, if one has three slits it is necessary to find at least the composition of three non-commutative matrices which belongs to its group and which does not change under permutation of any pair of them.

As far as we do not know any theoretical or experimental results devoted to the double-slit experiment under double-media conditions, we shall restrict with the homogeneous medium when $k_1 = k_2$, i.e. $L = 0$. Therefore we shall bring two connections between $j_s(NE, M)$, $j_s(E, M)$ and $j_s(NE, D)$, $j_s(E, D)$, where the first pair corresponds to the symmetric composition M , and the second one corresponds to the antisymmetric composition D :

$$\begin{aligned} j_s(E, M) &= [\cos^2 \frac{(N_1 - N_2) + (M_1 - M_2)}{2}] j_s(NE, M), \\ j_s(E, D) &= [\cos^2 \frac{(N_1 + N_2) + (M_1 + M_2)}{2}] j_s(NE, D). \end{aligned} \quad (33)$$

We remind that $j_3(NE, D)$, $j_0(NE, D)$ are constant in homogeneous medium in just the same way as $j_3(NE, M)$, $j_0(NE, M)$, therefore $j_3(E, D)$, $j_0(E, D)$ and $j_3(E, M)$, $j_0(E, M)$ are not constant. It means that last observables calculated by means of the ordinary superposition principle lead to violation of the conservation laws, excluding the points where

$$\begin{aligned} (N_1 - N_2) + (M_1 - M_2) &= \pm 2\pi n \quad \text{for } M, \quad n = 0, 1, \dots \\ (N_1 + N_2) + (M_1 + M_2) &= \pm 2\pi m \quad \text{for } D, \quad m = 0, 1, \dots \end{aligned} \quad (34)$$

The first expressions in (3.10) and (3.11) show that $j_s(E, M)$ are equal to $j_s(NE, M)$ at the points where two paths length difference is multiply to the wave length, i.e. at the points of peaks in interference pattern.

Two superposition rules are rather compared, now we shall briefly discuss the consequence of the non-Euclidean superposition principle concerning with the double-slit experiment in homogeneous medium restricting with symmetric and antisymmetric compositions M and D . Two observables, j_3 and j_0 , are conserved for both compositions whereas j_1 and j_2 at the final point F are dependent upon them at the initial point I as

$$\begin{aligned} j_1(F, M) &= \cos[(N_1 + M_1) + (N_2 + M_2)] j_1(I) + \sin[(N_1 + M_1) + (N_2 + M_2)] j_2(I), \\ j_2(F, M) &= -\sin[(N_1 + M_1) + (N_2 + M_2)] j_1(I) + \cos[(N_1 + M_1) + (N_2 + M_2)] j_2(I) \end{aligned} \quad (35)$$

for composition M , and for composition D as

$$\begin{aligned} j_1(F, D) &= \cos[(N_1 + M_1) - (N_2 + M_2)] j_1(I) + \sin[(N_1 + M_1) - (N_2 + M_2)] j_2(I), \\ j_2(F, D) &= -\sin[(N_1 + M_1) - (N_2 + M_2)] j_1(I) + \cos[(N_1 + M_1) - (N_2 + M_2)] j_2(I). \end{aligned} \quad (36)$$

The expressions (3.12), (3.13) and (2.19), (2.20) define two spiral lines with the same radii and step but having different torsion. It is interesting to note that the line defined by (3.12) does not depend on paths permutation whereas another one changes the torsion at the same time. These two spiral lines have also some other peculiarities, for example all $j_s(F, D)$ are conserved under condition $(N_1 + M_1) = (N_2 + M_2) \pm 2\pi n$.

4. Irreversibility in quantum mechanics

This problem is considered to be unsolved (Ginzburg, 1999; Kadomtzev, 2003) due to the fact that equations describing a physical phenomena, in particular the Schroedinger one, in a closed systems are reversible, they describe such phenomena highly satisfactory, but an entropy is increasing at the same time. Therefore it seems that a problem of irreversibility is

first of all the mathematical one, and the reversible equations have to be accepted as the initial condition.

It is quite clear that the irreversibility may be coupled with interactions. It is also quite clear that an interactions lead to non-commutativity of a propagators describing processes. We shall assume that the mathematical explanation of irreversibility may be carried out on the base of the non-commutative properties of transformations which are contained in the reversible equations, and the reversibility of equations is only necessary condition for the closed system reversible evolution, but perfectly insufficient for that. It would be meant that a reversible equations contain irreversibility in general case. Further we shall follow to the (Lunin & Kogan, 2004; 2009) where the subject is set forth in more details.

Transformations of solutions for the time-dependent Schroedinger equation in its spinor representation belong to the $SL(2, C)$ group. It describes a most general spinors transformations up to unessential scalar factor - matrix determinant. The last one for the $SL(2, C)$ -group matrix representation is equal to the unit.

Reversibility of the equations means in particular that any transformation has the inverse one, in just the same way as any group element has the inverse one. In other words, the equation reversibility and the group description of the transformations are closely connected.

The process is reversible if the system goes through the same sequence of states in reverse order under time inversion as it went in the straightforward one. It means that all conservation laws are the same in both processes, i.e. both ones are described by the same group. Interchange of lower and upper integration limits in the product integral leads to the propagator inversion $Q \rightarrow Q^{-1}$ (Gantmakher, 1988). In other words, if Q corresponds to the process $t_1 \rightarrow t_2$, then Q^{-1} corresponds to the process $t_2 \rightarrow t_1$.

As far as irreversibility is the experimental fact, we shall use the density matrix of pure states J from (2.7) based on observables j_s , it has no the inverse one. Then the irreversibility investigation means to investigate the consequences $J(t_0)...J(t_1)...J(t_2)...J(t)$ for times $t_0...t_1...t_2...t$ under inversion of the last consequence.

Let us assume $\Phi(t_1), \Phi(t_2)$ and $J(t_1), J(t_2)$ are to be the spinors and the density matrices correspondingly for arbitrary times t_1, t_2 . Let these spinors are connected by matrix $Q(t_2, t_1)$ from the group $SL(2, C)$ as $\Phi(t_2) = Q(t_2, t_1)\Phi(t_1)$. Then one has

$$J(t_1) = \frac{1}{2} \sum_{s=0}^3 \sigma_s \{ \Phi^+(t_1) \sigma_s \Phi(t_1) \}, J(t_2) = \frac{1}{2} \sum_{s=0}^3 \sigma_s \{ \Phi^+(t_1) Q^+(t_2, t_1) \sigma_s Q(t_2, t_1) \Phi(t_1) \}. \quad (37)$$

All propagators in (3.8), excluding T, T' , go to inverse ones under time inversion, they do not contain irreversibility. Let us consider one of two last compositions from (3.8) under inversion of both matrices entered it, and prove that $T(A^{-1}, B^{-1}) = T(A, B)$, i.e. $(A^{-1}B^2A^{-1})^{1/2}AB^{-1} = (AB^{-2}A)^{1/2}A^{-1}B$. Multiplying this equality on the right subsequently by B, A^{-1} and raising it to the second power one has

$$\begin{aligned} A^{-1}B^2A^{-1} &= (AB^{-2}A)^{1/2}A^{-1}B \cdot BA^{-1} \cdot (AB^{-2}A)^{1/2}A^{-1}B \cdot BA^{-1} = \\ &= (AB^{-2}A)^{1/2}(AB^{-2}A)^{-1}(AB^{-2}A)^{1/2}A^{-1}B^2A^{-1} = A^{-1}B^2A^{-1}, \end{aligned}$$

i.e. $T \rightarrow T$ under $A \rightarrow A^{-1}$ and $B \rightarrow B^{-1}$. The composition T' has the same properties.

Thus, we have the following transformations for propagators compositions in time-depending process $t_1 \rightarrow t_2 \rightarrow t_1$: $1 \rightarrow Q \rightarrow 1$, if Q is any reversible propagator, and $1 \rightarrow T \rightarrow T^2$ for irreversible composition T (or T').

Considering process $t_1 \rightarrow t_2 \rightarrow t_1$ and replacing Q in the second expression in (4.1) by T^2 one has finally the following expression for the matrix J

$$J(t_1 \rightarrow t_2 \rightarrow t_1) = \frac{1}{2} \sum_{s=0}^3 \sigma_s \{ \Phi^+(t_1) (T^2)^+ \sigma_s T^2 \Phi(t_1) \},$$

which does not coincide with $J(t_1)$ there. It means that the process is irreversible in general case. However, even this matrix may lead to a reversible process. A comparison of the last expression with $J(t_1)$ in (4.1) shows that such process is also reversible under conditions $(T^2)^+ \sigma_s T^2 = \sigma_s, s = 0, 1, 2, 3$, which lead to $T^2 = \sigma_0$, or $T = \pm \sigma_s$. As far as $T = \sigma_0$ under A and B commutativity, one may see that interaction is the necessary condition for irreversibility, but insufficient.

As an example of the system in which irreversibility may take place let us consider the double-slit experiment where point-wise slits are arranged at the two media boundary. A propagators for it were calculated in (3.9).

The reversibility condition, $t = 0$, as it is seen from (3.7), leads to the requirement

$\sqrt{1 - (\mathbf{n}_b \mathbf{n}_a)^2} \tanh b \tanh a = 0$. It means that the process is reversible if at least one vector \mathbf{a} or \mathbf{b} is equal to zero, or they are collinear.

Using expressions (3.9) the parameters of the vector \mathbf{a} may be expressed as

$$\begin{aligned} \cosh a &= \cosh L \cos(N_A + M_A), & n_{a1} \sinh a &= \sinh L \cos(N_A - M_A), \\ n_{a2} \sinh a &= \sinh L \sin(N_A - M_A), & n_{a3} \sinh a &= i \cosh L \cos(N_A + M_A), \end{aligned}$$

and similar for the vector \mathbf{b} .

If media are identical, i.e. $k_1 = k_2, L = 0$, interaction is absent, the propagators A and B are commutative, then the matrix $T = \sigma_0$. Therefore only reversible processes take place in homogeneous media.

If media are inhomogeneous but the propagators satisfy to the condition $\cosh L \cos(N_A + M_A) = \pm 1$ or $\cosh L \cos(N_B + M_B) = \pm 1$, then $T = \sigma_0$, i.e. one has also reversibility.

Irreversibility takes place for the points where these conditions are violated.

Irreversibility of some process taking place in a closed system has to become apparent to an observer. It means that some observables, i.e. some Hermitian forms, have to be influenced by irreversible process.

Let some process in a closed system is irreversible along $t_1 \rightarrow t_2 \rightarrow t_1$, and A and B are two corresponding non-commutative propagators from $SU(1, 1)$ group representable as

$A = \exp[(\mathbf{n}_a \boldsymbol{\sigma})a], B = \exp[(\mathbf{n}_b \boldsymbol{\sigma})b]$. We shall also assume for definiteness that $(1/2)TrA > 1, (1/2)TrB > 1$, the lengths of vectors \mathbf{a} and \mathbf{b} are real under these conditions.

Let the system evolution is a repeating process mentioned above, and if $\Delta t = t_2 - t_1$ then time duration of n -multi-periodic process is $2n\Delta t$ and the lengths of vectors \mathbf{a} and \mathbf{b} are also increased by $2n$ times.

Thus, irreversibility has to be appeared as dependence of some observables calculated by means of the composition T on number of cycles n .

The value $(\mathbf{n}_b \mathbf{n}_a) \neq \pm 1$ due to A and B non-commutativity, then the length of the vector \mathbf{t} is positive. The length \tilde{t} of the vector \mathbf{t} after n -multiple repetitions of the process will be defined by

$$\tanh \tilde{t} = \sqrt{1 - (\mathbf{n}_b \mathbf{n}_a)^2} \frac{\tanh 2nb \tanh 2na}{1 - (\mathbf{n}_b \mathbf{n}_a) \tanh 2nb \tanh 2na}. \quad (38)$$

Calculating correspondent matrices on the base of composition T we shall obtain the expression for \tilde{j}_0 after n -times repetitions of the process:

$$\tilde{j}_0 = \frac{\{1 + (1 + 2\frac{t_3^2}{t^2}) \tanh^2 \tilde{t}\} j_0 + 2\frac{t_1 j_1 + t_2 j_2}{t} \tanh \tilde{t} + 2t_3 \frac{t_1 j_2 - t_2 j_1}{t^2} \tanh^2 \tilde{t}}{1 - \tanh^2 \tilde{t}}, \quad (39)$$

where j_s are the observables at the beginning of process. It was taken into account here that all t_s/t do not depend on n , and, as far as a_1, a_2 are real and a_3 is imaginary and the same for b_s , it is also accepted here $t_3 \rightarrow it_3$, so that t_3 in (4.3) is real.

The value $\tilde{j}_0 = \Phi^+ \Phi$ is positive defined, the value \tilde{j}_0 coincides with j_0 at the beginning of process. It is seen from (4.2) that \tilde{t} is restricted under $n \rightarrow \infty$, then \tilde{j}_0 in (4.3) is positive, increases and also restricted under this condition. Besides, it is the only positive defined functional.

There were carried out the geometric analysis of irreversibility, and also the functional \tilde{j}_0 in (Lunin & Kogan, 2009). It was shown there that the functional is closely connected with the area of triangle defined by vectors \mathbf{a} and \mathbf{b} on the Lobachevsky plane. This area is coupled in turn with the Berry phase. Such consideration allows also to show that the functional grows more quickly under interaction increase.

It may be assumed that this functional may be coupled with an entropy.

5. Conclusion

Three subjects connected with quantum mechanics considered above allow one to make some conclusions. Two of them, the observables set completeness and the superposition principle, lie in the foundations of quantum mechanics, the third one, an irreversibility, is its essential consequence.

The first topic of the paper is devoted to an analysis of the conventional quantum mechanics structure from the view point of requirements of the observables set completeness and fulfilment of the conservation laws for them. Both last subjects are closely connected among themselves, and with the group theory, of course.

As long as different observables may be connected with each other in accordance with the uncertainty relations in the conventional forms of quantum mechanics, then the observables completeness obtains an exceptional sharpness. If one has no complete set of them then it is impossible to prove that the theory includes all similar relations, even for the known observables.

Considering a stationary Schroedinger equation it was defined the complete set of the Hermitian forms based only on the complex wave function and its derivative. It may be said that the complete set is a consequence of only the equation and combinatorial analysis. These Hermitian forms contain only the same variables which are used for probability density and its current in the ordinary forms of quantum mechanics.

The complete set includes four Hermitian forms, they satisfy to some identity in any case, therefore it may be considered as the completeness condition, and only three of them are independent. The set is also applicable to the time-dependent Schroedinger equation as far as the last one contains only the first order time derivative.

Since the stationary Schroedinger equation is similar to the Helmholtz one, the complete set of the Hermitian forms is also similar to the Stokes parameters, they satisfy to the same identity. Obviously, that the *complete* set contains the parameters used in quantum mechanics now, and also the hidden parameters discussed there. As far as the set of the Stokes parameters

is complete and known during many decades, the complete set of the Hermitian forms connected with the Schroedinger equation and described here is similar to them, one may say that there are an unused parameters in quantum mechanics but not at all a hidden ones.

The complete set of observables is assumed to have a spatial interpretation. An analysis of the free particle conservation laws fulfilment under arbitrary initial conditions based on the complete set of observables shows that a spatial line where all necessary conservation laws are fulfilled is the spiral line in a general case, such line may be named as the free particle trajectory. Obviously, that even free quantum particle has a transversal motion components in this case.

Consideration of the trajectories transformations under some simplest potentials shows that the spiral line may turn to the straight line under some conditions, and vice versa.

The observables transformation on the step-wise potential which is similar to the Lorentz one allows one to suspect that such transformation may play a role of a bridge between quantum mechanics and special relativity.

Combination of the complete set of observables with its spatial interpretation allows one to say that the quantum particle position is defined uniquely by initial conditions and conservation laws. An ordinary probabilistic interpretation in quantum mechanics is assumed to be connected with some unused, and unmeasured of course, parameters containing transversal components of a particle motion.

The observables completeness or its absence influences also on the wave function interpretation. The observables at the initial point have to define the wave function and its derivative there. If some part of observables is unknown, i.e. is not measured or is not considered at all, then the wave function can not be defined uniquely, even taking into account a phase factor, therefore any interpretation of the wave function, including probabilistic one, can not be proved. Such situation takes place now in the conventional quantum mechanics.

In the opposite case, when the complete set of observables is included into the theory, a quantum particle position is assumed to be uniquely defined. Any interpretation of the wave function is not necessary in this case although the last one may be expressed via observables, as well as its derivative.

The observable complete set leads to a definite position of quantum particle. Obviously, to prove an ordinary probabilistic interpretation in quantum mechanics it is necessary to prove in turn that it is necessary to exclude from consideration some Hermitian forms which are constructed on the basis of the *same* variables, ψ and $\nabla\psi$, as used for construction of ρ and \mathbf{j} in the conventional schemes, and which define a transverse components of quantum particle motion.

This approach has led to the uniquely defined trajectories of quantum particle on the one hand, and to the unclassical their configuration, the spiral lines, on the other hand. These two circumstances has led to an explanation of the point-wise traces on the one hand, and to a qualitative one of their distribution on the other hand in the double-slit experiment with a single-particles source without use of a wave function collapse and a particle-wave dualism.

The second topic of the paper is a consideration of the superposition principle in quantum mechanics from the point of view of the Noether theorems. These theorems require the rigorous group-theoretic construction of the fundamental physical theories due to the necessary requirement of the conservation laws fulfilment. The last one is the consequence of the space symmetries.

The approach proposed in the paper has led to the non-Euclidean superposition principle which allows one to fulfill these requirements.

A successive matrix transformations of solutions for the Schroedinger, the Helmholtz and other similar wave equations are non-commutative in a general case. Such transformations may be geometrically mapped into a curved spaces, in particular into the Lobachevsky space with the Gaussian curvature $C_G = -4$ as it was shown above. The problems similar to interference ones require to use some composition rule for alternative transformations, and a use of the ordinary superposition principle leads to the compositions on the complex Euclidean plane, i.e. in the flat space. Therefore one has the situation when we need to compose the same objects (transformations or solutions) either in the one, curved, space or in the other, flat, space.

The non-Euclidean superposition principle allows one to compose all transformations, successive and alternative, in the common space with the Gaussian curvature defined by the equation.

To compare the ordinary superposition principle and the non-Euclidean one it was considered the double-slit experiment when both slits are arranged at the two-media boundary. The approach assumes to consider also a homogeneous medium.

As far as the case with a boundary independently calculated on the base of the ordinary superposition principle is not known to author, consideration of the conservation laws fulfilment was carried out on the base of the partial propagators calculated by means of the product integral, and subsequent comparison of two different rules of their compositions, in accordance with the ordinary and non-Euclidean superposition principles. Such comparison was carried out also for the case of the homogeneous medium.

It was shown that the non-Euclidean superposition principle leads to fulfilment of the conservation laws everywhere under presence or absence of a boundary.

The ordinary superposition principle leads to its fulfilment only at the points of peaks of the interference pattern, and to their violation in the other points.

Two compositions entered the non-Euclidean superposition principle, symmetric and antisymmetric with respect to permutations, are considered to see a differences to which they may lead. It may be assumed that these compositions may be connected with bosons and fermions correspondingly, in particular under conditions of the double-slit experiment with such kinds particles.

Taking into account expressions (3.12) and (3.13) one may see that they having different permutation properties lead to different spatial behavior of the j_1 and j_2 in both cases. The experiments with particles of different kinds mentioned above, particularly with polarized ones, i.e. $j_1 \simeq 0$ or $j_2 \simeq 0$, may demonstrate in principle these differences.

It may be assumed that a differences of similar kind are contained also in the ordinary forms of quantum mechanics, for example differences for the central peak in interference pattern for bosons and fermions.

Here it is necessary to take into account that the central peak in the interference pattern is the same for bosons and fermions in accordance with point of view accepted now (Feynman, 1965).

Such kind experiments in combination with expression $\rho = \chi\chi^* = (j_0 + j_1)/(2k)$, which does not contain $j_2(F)$, and expressions (3.12), (3.13) for polarized particles may be found also useful to compare the probability interpretation of the density ρ in the quantum mechanics ordinary forms and complete set of observables proposed here experimentally.

Obviously that more rich opportunities appear in the case of the double-slit experiment arranged at the two-media boundary with polarized particles.

The last topic considered in the paper concerns with the irreversibility in quantum mechanics. The problem consists of the circumstance that all the main equations, in particular the Schroedinger one, are reversible, and they describe a physical phenomena satisfactorily excluding irreversible processes. A known attempts to solve the problem contain a proposals to introduce different modifications into existing theory which may lead to the unacceptable changes concerning with reversible processes taking place simultaneously with irreversible ones in the closed physical systems.

The approach proposed in this paper and based on the non-Euclidean superposition principle comes from the reversible Schroedinger equation which includes interactions. Any partial propagators are reversible in this case, all of them belong to some group therefore any propagator has the inverse one. Any such propagator turns to the inverse one under time inversion, as well as some of their compositions entered the non-Euclidean superposition principle. It means that they do not contain irreversibility, and reversible processes described with the reversible Schroedinger equation take place in the closed systems even under interactions.

However, two binary compositions entered the non-Euclidean superposition principle, T and T' , do not turn into the inverse ones under time inversion, for example $T \rightarrow T$ under such time transformation. It means that such kind binary composition is transformed as $1 \rightarrow T \rightarrow T^2$ under $t_1 \rightarrow t_2 \rightarrow t_1$ in general case, and such composition may contain irreversibility.

Thus, a reversibility of the Schroedinger equation is only the necessary condition for a closed physical system reversible evolution but not the sufficient one, on the one hand. On the other hand, it is obviously that inclusion into the Schroedinger equation of some irreversible terms may lead only to the irreversibility for any processes their.

In an opposite way, the non-Euclidean superposition principle assumes coexistence of both reversible and irreversible processes simultaneously in the closed physical systems described with the only the reversible Schroedinger equation.

Let us note two circumstances connected with the opportunity to include irreversibility into the quantum mechanics scheme.

The first one is following: none partial (single) propagators do not contain irreversibility, it is necessary to find at least some their binary compositions. The second one necessarily implying interactions in a system, leads to mapping all propagators and their compositions into the Lobachevsky space, i.e. into the curved space.

It is interesting to compare these circumstances with two conclusions from (Prigogine & Stengers, 1994) which are the following:

- a) Irreversibility expressed by the time arrow is a statistical property. It can not be introduced in terms of individual paths or wave functions. Therefore it demands a radical withdrawal from the Newtonian mechanics or from orthodox quantum mechanics based on concepts of the individual path or wave function;
- b) The main assumption that we have to introduce here is the statement that the space with zero Gaussian curvature, similar to the Minkowski space, does not contain entropy, which are cited unfortunately only in the reverse translation from Russian.

It would be recognized that these expressions formulate the really necessary conditions of irreversibility as it was shown above.

The approach stated above allows one to express the following general point of view on the structure of the fundamental theories.

Taking the exceptional role of the group theory and the Noether theorems in such physical theories into account the last ones may be split into two classes. The first one consists of

the theories constructed before the Noether theorems establishment, and the second ones constructed later.

Evidently that it is difficult to assume the consecutive group-theoretic construction of the first class theories. In opposite case, the theories of the second class would be assumed to be the group-theoretic ones, since the Noether theorems were known to the time of their development.

Therefore it seems to be useful to carry out the group-theoretic analysis of the foundations of the first class theories, whereas a similar consideration of the second class theories seems to be unnecessary.

Besides, it would be considered in both cases if the ordinary (Euclidean) superposition principle, if it used there, is sufficient for the aims of the theory, or insufficient.

Author is grateful to V. I. Kogan (Kurchatov, MEPhI) for many years collaboration, and to V. I. Man'ko (Lebedev) for his active support.

E-mail: n.v.lunin@sandy.ru

6. References

- Biberman, L., Sushkin, N. & Fabrikant, V. (1949). Diffraction of One by One Flying Electrons. *Doklady Acad. Nauk USSR, Physics*, Vol. 66, No. 2, pp. 185-186 (in Russian)
- Bukreev, B.Ya. (1951). *Geometry of Lobachevsky Plane*, GITTL, Moscow (in Russian)
- Casanova, G. (1976). *L'Algebre Vectorielle*, Press. Univers. de France
- Dirac, P.A.M. (1958). *The Principles of Quantum Mechanics*, Clarendon Press, Oxford
- Dirac, P.A.M. (1978). *Direction in Physics*, Hora, T. & Shepanski, J.R. (Ed.), John Wiley and Sons, New York
- Einstein, A., Podolsky, B. & Rosen, N. (1935). Can Quantum - Mechanical Description of Physical Reality Be Considered Complete? *Phys. Rev.*, Vol.47, 777-780
- Feynman, R.P., Leighton, R.B. & Sands, M. (1963). *The Feynman Lectures on Physics*, Vol.3, Addison-Wesley, Reading, Massachusetts
- Feynman, R. (1965). *The Character of Physical Law*, Cox and Wyman LTD, London
- Feynman, R.P. & Hibbs, A.R. (1965). *Quantum Mechanics and Path Integrals*, McGraw-Hill Book Comp., New York
- Feynman, R.P. (1972). *Statistical Mechanics*, W.A.Benjamin Inc., Massachusetts
- Gantmakher, F.R. (1988). *Theory of Matrices*, Nauka, Moscow (in Russian)
- Ginzburg, V.L. (1999). What Problems of Physics and Astrophysics Seem Now to Be Especially Important? *Phys. Usp.*, Vol.42, April, pp.353-373
- Goldstein, S. (1998). Quantum Theory without Observers. *Physics Today*, June, pp.38-42
- Greenstein, G. & Zajonc, A.G. (2006). *The Quantum Challenge*, Jones and Bartlett Publ., Sudbury, Massachusetts
- Kadomtzev, B.B. (2003). Irreversibility in Quantum Mechanics. *Phys. Usp.*, Vol. 46, November, pp.1183-1201
- Kolkunov, V.A. (1969). Problems of S-matrix (semi-classics). *Soviet J. Nucl. Phys.*, Vol.10, No.6, pp. 1296-1303 (in Russian)
- Kolkunov, V.A. (1970). Problems of S-matrix. *Soviet Theor. Math. Physics*, Vol.2, No.2, pp.169-179 (in Russian)
- Landau, L.D. & Lifshitz, E.M. (1963). *Quantum Mechanics*, GIFML, Moscow (in Russian)
- Lankaster, P. (1969). *Theory of Matrices*, Academic Press, New York - London
- Lontano, M. & Lunin, N. (1991). Propagation of Electromagnetic Waves in a Density-Modulated Plasma. *J. Plasma Physics*, Vol. 45, No. 2, pp.173-190

- Lunin, N.V. (1994). Path Product Integral and Lobachevsky Geometry in Quantum Theory. *Preprint IAP*, No. 354, Nizhny Novgorod
- Lunin, N.V. (1998). The Superposition Principle in Quantum Mechanics. *Preprint IAE-6113/6*, Moscow
- Lunin, N.V. (1999). Superposition Principle in Quantum Theory. *Doklady RAS Physics*, Vol.44, No.9, pp. 595-599
- Lunin, N.V. (2002). Non-Euclidean Superposition Principle and Conservation Laws in the Feynman Scheme of Quantum Mechanics. *Vestnik of Nizh. Novg. University. Math. Simul. Optim. Contr.*, No. 1(25), pp.120-141 (in Russian)
- Lunin, N.V. & Kogan, V.I. (2004). On Irreversibility in Quantum Mechanics. *Doklady RAS Physics*, Vol. 49, No. 12, pp.723-726
- Lunin, N.V. (2008). Completeness of Observables and Particle Trajectories in Quantum Mechanics. *J. Russian Laser Research*, Vol. 29, No. 5, pp.441-459
- Lunin, N.V. & Kogan, V.I. (2009). Irreversibility in Quantum Mechanics. *Applied Physics*, No. 6, pp.9-23 (in Russian)
- Malkin, I.A. & Man'ko, V.I. (1979). *Dynamic Symmetries and Coherent States in Quantum Systems*, Nauka, Moscow (in Russian)
- Olver, P. (1986). *Applications of Lie Groups to Differential Equations*, Springer-Verlag, New York
- Poznyak, E.G. & Shikin, E.V. (1990). *Differential Geometry*, Moscow University, Moscow (in Russian)
- Prigogine, I., & Stengers, I. (1994). *Time, Chaos, Quantum*, Freeman, New York
- Tonomura, A., Endo, J., Matsuda, T., Kawasaki, T. & Exawa, H. (1989). Demonstration of Single-Electron Buildup of an Interference Pattern. *Amer. J. Physics*, Vol. 57, pp. 117-120
- Zhelobenko, D.P. & Shtern, A.I. (1983). *Representations of Lie Groups*, Nauka, Moscow (in Russian)

The Pancharatnam-Berry Phase: Theoretical and Experimental Aspects

Francisco De Zela
Departamento de Ciencias, Sección Física
Pontificia Universidad Católica del Perú, Apartado, Lima
Peru

1. Introduction

In 1984 Berry addressed a quantum system undergoing a unitary and cyclic evolution under the action of a time-dependent Hamiltonian (M. V. Berry, 1984). The process was supposed to be adiabatic, meaning that the time scale of the system's evolution was much shorter than the time scale of the changing Hamiltonian. Until Berry's study, it was assumed that for a cyclic Hamiltonian the quantum state would acquire only so-called dynamical phases, deprived of physical meaning. Such phases could be eliminated by redefining the quantum state through a "gauge" transformation of the form $|\psi\rangle \rightarrow e^{i\alpha} |\psi\rangle$. However, Berry discovered that besides the dynamical, there was an additional phase that could not be "gauged away" and whose origin was geometric or topological. It depended on the path that $|\psi\rangle$ describes in the parameter space spanned by those parameters to which the Hamiltonian owed its time dependence. Berry's discovery was the starting point for a great amount of investigations that brought to light topological aspects of both quantum and classical systems. Berry's phase was soon recognized as a special case of more general phases that showed up when dealing with topological aspects of different systems. For example, the Aharonov-Bohm phase could be understood as a geometric phase. The rotation angle acquired by a parallel-transported vector after completing a closed loop in a gravitationally curved space-time region, is also a geometric, Berry-like phase. Another example is the precession of the plane of oscillation of a Foucault pendulum.

Berry's original formulation was directly applicable to the case of a spin-1/2 system evolving under the action of a slowly varying magnetic field that undergoes cyclic changes. A spin-1/2 system is a special case of a two-level system. Another instances are two-level atoms and polarized light, so that also in these cases we should expect to find geometric phases. In fact, the first experimental test of Berry's phase was done using polarized, classical light (A. Tomita, 1986). Pancharatnam (S. Pancharatnam, 1956) anticipated Berry's phase when he proposed, back in 1956, how to decide whether two polarization states are "in phase". Pancharatnam's prescription is an operational one, based upon observing whether the intensity of the interferogram formed by two polarized beams has maximal intensity. In that case, the two polarized beams are said to be "in phase". Such a definition is analogous to the definition of distant parallelism in differential geometry. Polarized states can be subjected to different transformations which could be cyclic or not, adiabatic or not, unitary or not.

And in all cases Pancharatnam's definition applies. Pancharatnam's phase bore therefore an anticipation and – at the same time – a generalization of Berry's phase. Indeed, Berry's assumptions about a cyclic, adiabatic and unitary evolution, turned out to be unnecessary for a geometric phase to appear. This was made clear through the contributions of several authors that addressed the issue right after Berry published his seminal results (Y. Aharonov, 1987; J. Samuel, 1988).

Pancharatnam's approach, general as it was when viewed as pregnant of so many concepts related to geometric phases, underlay nonetheless two important restrictions. It addressed nonorthogonal and at the same time pure, viz totally, polarized states. Here again the assumed restrictions turned out to be unnecessary. Indeed, it was recently proposed how to decide whether two orthogonal states are in phase or not (H. M. Wong, 2005). Mixed states have also been addressed (A. Uhlmann, 1986; E. Sjöqvist, 2000) in relation to geometric phases which – under appropriate conditions – can be exhibited as well-defined objects underlying the evolution of such states.

The present Chapter should provide an overview of the Pancharatnam-Berry phase by introducing it first within Berry's original approach, and then through the kinematic approach that was advanced by Simon and Mukunda some years after Berry's discovery (N. Mukunda, 1993). The kinematic approach brings to the fore the most essential aspects of geometric phases, something that was not fully accomplished when Berry first addressed the issue. It also leads to a natural introduction of geodesics in Hilbert space, and helps to connect Pancharatnam's approach with the so-called Bargmann invariants. We discuss these issues in the present Chapter. Other topics that this Chapter addresses are interferometry and polarimetry, two ways of measuring geometric phases, and some recent generalizations of Berry's phase to mixed states and to non-unitary evolutions. Finally, we show in which sense the relativistic effect known as Thomas rotation can be understood as a manifestation of a Berry-like phase, amenable to be tested with partially polarized states. All this illustrates how – as it has often been the case in physics – a fundamental discovery that is made by addressing a particular issue, can show afterwards to bear a rather unexpected generality and applicability. Berry's discovery ranks among this kind of fundamental advances.

2. The adiabatic and cyclic case: Berry's approach

Let us consider a non-conservative system, whose evolution is ruled by a time-dependent Hamiltonian $H(t)$. This occurs when the system is under the influence of an environment. The configuration of the environment can generally be specified by a set of parameters (R_1, R_2, \dots) . For a changing environment the R_i are time-dependent, and so also the observables of the system, e.g., the Hamiltonian: $H(R(t)) \equiv H(R_1(t), R_2(t), \dots) = H(t)$. The evolution of the quantum system is ruled by the Schrödinger equation, or more generally, by the Liouville-von Neumann equation (in units of $\hbar = 1$):

$$i \frac{d\rho(t)}{dt} = [H(R(t)), \rho(t)]. \quad (1)$$

Here, the density operator ρ is assumed to describe a pure state, i.e., to be of the form $\rho(t) = |\psi(t)\rangle \langle\psi(t)|$. An "environmental process" is given by $t \rightarrow R(t)$, the curve described by the vector R in parameter space. To such a process it corresponds a curve described by $|\psi(t)\rangle$ in the Hilbert space \mathcal{H} to which it belongs, or by the corresponding curve $\rho(t) = |\psi(t)\rangle \langle\psi(t)|$

in the “projection space” $\mathcal{P}(\mathcal{H})$ to which ρ belongs. We will assume that for all R there is an orthonormal basis $|n; R\rangle$ such that

$$H(R) |n; R\rangle = E_n(R) |n; R\rangle. \quad (2)$$

An environmental process $R(t)$ is called periodic with period T , whenever $R(T) = R(0)$, $E_n(R(T)) = E_n(R(0))$, and $|n; R(T)\rangle \langle n; R(T)| = |n; R(0)\rangle \langle n; R(0)|$. Of course, we can change the eigenbasis according to $|n; R\rangle \rightarrow |n; R'\rangle = e^{i\alpha_n(R)} |n; R\rangle$, which is called a gauge transformation. When the adiabatic approximation was first studied, people assumed that it would be always possible to get rid of phase factors by simply performing a gauge transformation, if necessary (A. Bohm, 2003). Berry’s discovery made clear that this is not always the case. The point is that we are not always totally free to choose the required phase factors when performing gauge transformations. Let us see why it is so. To this end, we consider first two simple cases in which phase factors appear that can be eliminated. A first case is a conservative system ($\partial H/\partial t = 0$). The initial condition $|\psi(0)\rangle = |n; R\rangle$ leads to $|\psi(t)\rangle = \exp(-iE_n t) |n; R\rangle$. In this case the phase factor can be gauged away. A second case is a non-conservative system whose Hamiltonian is such that $[H(t), H(t')] = 0$ for all t and t' . In this case $|\psi(t)\rangle = \exp(-i \int_0^t dt' E_n(t')) |n; R(0)\rangle$ and the phase factor can again be gauged away. Now, if $[H(t), H(t')] \neq 0$ the evolution is given by $|\psi(t)\rangle = \mathcal{T} \left[\exp(-i \int_0^t dt' E_n(t')) \right] |n; R(0)\rangle$, where \mathcal{T} means the time-ordering operator. In this case, the phase-factor cannot generally be gauged away. To see why is this the case, let us first restrict ourselves to a slowly evolving Hamiltonian and to an *approximate* solution of Eq.(1), the so-called adiabatic approximation:

$$\rho(t) = |\psi(t)\rangle \langle \psi(t)| \approx |n; R(t)\rangle \langle n; R(t)|. \quad (3)$$

When $R(t)$ describes a closed path ($R(T) = R(0)$) so also does $\rho(t)$ under the adiabatic approximation, because the eigenprojectors are single-valued: $|\psi(T)\rangle \langle \psi(T)| \approx |n; R(T)\rangle \langle n; R(T)| = |n; R(0)\rangle \langle n; R(0)|$. However, the state $|\psi(t)\rangle$ may acquire a phase. Note that $|\psi(t)\rangle \langle \psi(t)| \approx |n; R(t)\rangle \langle n; R(t)|$ cannot be upgraded to an equality. This follows from observing that $H(R(t))$ and $|n; R(t)\rangle \langle n; R(t)|$ commute, so that for $|\psi(t)\rangle \langle \psi(t)| = |n; R(t)\rangle \langle n; R(t)|$ to satisfy Eq.(1), it must be stationary. Let us see under which conditions the adiabatic approximation applies. Writing $|\psi(t)\rangle = \sum_k c_k(t) |k; R(t)\rangle$, the adiabatic approximation means that $|\psi(t)\rangle \approx c_n(t) |n; R(t)\rangle$, with $c_n(0) = 1$, because $|\psi(0)\rangle = |n; R(0)\rangle$. By replacing such a $|\psi(t)\rangle$ in the Schrödinger equation one easily obtains the necessary and sufficient conditions for the validity of the adiabatic approximation (A. Bohm, 2003):

$$\frac{dc_n}{dt} |n; R(t)\rangle \approx -c_n \left[iE_n(t) |n; R(t)\rangle + \frac{d}{dt} |n; R(t)\rangle \right]. \quad (4)$$

Multiplying this equation by $\langle k; R(t)|$ it follows that

$$\langle k; R(t)| \frac{d}{dt} |n; R(t)\rangle \approx 0, \quad \text{for all } k \neq n. \quad (5)$$

By deriving Eq.(2) with respect to t this condition can be brought, after some calculations, to the form

$$\frac{\langle k; R(t) | dH(t)/dt | n; R(t) \rangle}{E_n(R) - E_k(R)} \approx 0, \quad \text{for all } k \neq n. \quad (6)$$

Hence, the energy differences $E_n(R) - E_k(R)$ – or correspondingly, the transition frequencies of the evolving system – set the time scale for which the variation of $H(t)$ can be considered “adiabatic”, and $|\psi(t)\rangle \approx c_n(t) |n; R(t)\rangle$ a valid approximation. Next, we multiply Eq.(4) by $\langle n; R(t) |$ and obtain

$$\frac{dc_n}{dt} = -c_n \left[iE_n(t) + \langle n; R(t) | \frac{d}{dt} | n; R(t) \rangle \right], \quad (7)$$

whose solution is

$$c_n(t) = \exp \left[-i \int_0^t E_n(s) ds \right] \exp \left[- \int_0^t \langle n; R(s) | \frac{d}{ds} | n; R(s) \rangle ds \right] \equiv \exp \left(-i\Phi_{dyn}(t) \right) \exp \left(i\gamma_n(t) \right). \quad (8)$$

Here,

$$\gamma_n(t) = i \int_0^t \langle n; R(s) | \frac{d}{ds} | n; R(s) \rangle ds \quad (9)$$

is the geometric phase, which is defined modulo 2π . We see that it appears as an additional phase besides the dynamical phase Φ_{dyn} . We have thus,

$$|\psi(t)\rangle \approx c_n(t) |n; R(t)\rangle = \exp \left(-i\Phi_{dyn}(t) \right) \exp \left(i\gamma_n(t) \right) |n; R(t)\rangle. \quad (10)$$

The geometric phase γ_n can also be written in the following way, to make clear that it does not depend on the parameter s :

$$\gamma_n(t) = i \int_{R(0)}^{R(t)} \langle n; R | \frac{\partial}{\partial R_k} | n; R \rangle dR_k \equiv \int_{R(0)}^{R(t)} \mathbf{A}^{(n)} \cdot d\mathbf{R}. \quad (11)$$

The vector potential $\mathbf{A}^{(n)} \equiv i \langle n; R | \nabla | n; R \rangle$ is known as the *Mead-Berry vector potential*. Eq.(11) makes clear that γ_n depends only on the path defining the environmental process, i.e., the path joining the points $R(0)$ and $R(t)$ in parameter space. This highlights the geometrical nature of γ_n . Now, one can straightforwardly prove that a gauge transformation $|n; R\rangle \rightarrow |n; R\rangle' = e^{i\alpha_n(R)} |n; R\rangle$ causes the vector potential to change according to

$$\mathbf{A}^{(n)} \rightarrow \mathbf{A}'^{(n)} = \mathbf{A}^{(n)} - \nabla \alpha_n(R). \quad (12)$$

As a consequence, the geometric phase transforms as

$$\gamma_n(t) \rightarrow \gamma_n'(t) = \gamma_n(t) - [\alpha_n(R(t)) - \alpha_n(R(0))]. \quad (13)$$

At first sight, gauge freedom seems to be an appropriate tool for removing the additional phase factor $\exp(i\gamma_n)$ in Eq.(10). Indeed, we can repeat the calculations leading to Eq.(10) but now using $|n; R\rangle' = e^{i\alpha_n(R)} |n; R\rangle$ instead of $|n; R\rangle$. We thus obtain an equation like Eq.(10) but with primed quantities. We could then choose $\alpha_n(R(t)) = -\gamma_n'(t)$ (modulo 2π) and so obtain

$$|\psi(t)\rangle \approx \exp \left(i\Phi_{dyn}(t) \right) |n; R(t)\rangle. \quad (14)$$

This is what V. Fock made when addressing adiabatic quantal evolutions (A. Bohm, 2003), thereby exploiting the apparent freedom one has for choosing $\alpha_n(R)$ when defining the eigenvectors $|n;R\rangle' = e^{i\alpha_n(R)} |n;R\rangle$. However, when the path C is closed, a restriction appears that limits our possible choices of phase factors. This follows from the fact that $R(T) = R(0)$ implies that $|n;R(T)\rangle = |n;R(0)\rangle$, because eigenvectors are single-valued (something we can always assume when a single patch is needed for covering our whole parameter space; otherwise, trivial phase factors are required). The eigenvectors $|n;R\rangle'$ are also single-valued, so that $|n;R(T)\rangle' = e^{i\alpha_n(R(T))} |n;R(T)\rangle = e^{i\alpha_n(R(0))} |n;R(0)\rangle = |n;R(0)\rangle' = e^{i\alpha_n(R(0))} |n;R(T)\rangle$. We have thus the restriction $\exp(i\alpha_n(T)) = \exp(i\alpha_n(0))$, which translates into $\alpha_n(T) = \alpha_n(0) + 2\pi m$, with m integer. Hence, because of Eq.(13),

$$\gamma_n(T) \longrightarrow \gamma_n'(T) = \gamma_n(T) - 2\pi m, \tag{15}$$

and we conclude that $\gamma_n(T)$ is *invariant*, modulo 2π , under gauge transformations. Thus, it cannot be gauged away, as initially expected. According to Eq.(11) γ_n is independent of the curve parameter (t), so that we should write $\gamma_n(C)$ instead of $\gamma_n(T)$. We have, finally,

$$|\psi(T)\rangle = \exp(-i\Phi_{dyn}(T)) \exp(i\gamma_n(C)) |\psi(0)\rangle, \tag{16}$$

with

$$\Phi_{dyn}(T) = \int_0^T E_n(t) dt, \tag{17}$$

$$\gamma_n(C) = \oint_C \mathbf{A}^{(n)} \cdot d\mathbf{R}. \tag{18}$$

This is Berry’s result (M. V. Berry, 1984). The vector potential $\mathbf{A}^{(n)}$ behaves very much like an electromagnetic potential. The phase factors $\exp(i\alpha_n(R))$ belong to the group $U(1)$, hence the name “gauge transformations” given to the transformations $|n;R\rangle \rightarrow |n;R\rangle' = e^{i\alpha_n(R)} |n;R\rangle$. As in electromagnetism, we can also here introduce a field tensor $\mathbf{F}^{(n)}$ whose components are

$$F_{ij}^{(n)} = \frac{\partial}{\partial R_i} A_j^{(n)} - \frac{\partial}{\partial R_j} A_i^{(n)}. \tag{19}$$

Geometrically, $\mathbf{F}^{(n)}$ has the meaning of a “curvature”. In differential geometry, where the language of differential forms is used, $\mathbf{A}^{(n)}$ is represented by a one-form, and $\mathbf{F}^{(n)}$ by a two-form. When the parameter space is three-dimensional, Eq.(19) can be written as

$$\mathbf{F}^{(n)} = \nabla \times \mathbf{A}^{(n)}. \tag{20}$$

Eq.(18) can then be written as

$$\gamma_n(C) = \int_S \mathbf{F}^{(n)} \cdot d\mathbf{S}, \tag{21}$$

with the surface element $d\mathbf{S}$ directed normally to the surface S , whose boundary is the curve C .

A paradigmatic case corresponds to a spin-1/2 subjected to a variable magnetic field $\mathbf{B}(t) = B\mathbf{n}(t)$, with $\mathbf{n}(t) \cdot \mathbf{n}(t) = 1$, see Fig.(1). The time-dependent Hamiltonian is then

$H(t) = -B(e/2mc)\mathbf{n}(t) \cdot \vec{\sigma}$, with $\vec{\sigma}$ the triple of Pauli matrices. The parameter space has the topology of the unit sphere S^2 . It is not possible to assign coordinates to all point in S^2 with a single patch. One needs at least two of them, which requires introducing two vector potentials, one for each patch. They are related to one another by a gauge transformation, i.e., their difference is a gradient. The corresponding curvature three-vector $\mathbf{F} = \nabla \times \mathbf{A}$ is given by $\mathbf{F} = -\mathbf{e}_r/2r^2$, with \mathbf{e}_r the unit radial vector. We note in passing that $\mathbf{F} = -\mathbf{e}_r/2r^2$ looks like a Coulomb field, while $\mathbf{F} = \nabla \times \mathbf{A}$ looks like a magnetic field. This hints at a formal connection between Berry's phase and Dirac's magnetic monopoles. In this case, $\gamma_n(C) = \int_S \mathbf{F} \cdot d\mathbf{S} = \int_S F_r r^2 \sin\theta d\theta d\varphi = -\int_S d\Omega/2$, so that

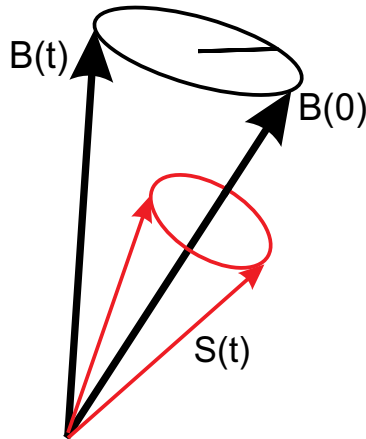

Fig. 1. A spin-1/2 subjected to a variable magnetic field $\mathbf{B}(t)$ that describes a closed trajectory. When the field changes slowly in the time scale of the spin dynamics, then the spin \mathbf{S} can follow the field adiabatically. After a period, the spin state has accumulated a geometric phase in addition to the dynamical one.

$$\gamma_n(C) = -\Omega(C)/2, \quad (22)$$

$\Omega(C)$ being the solid angle enclosed by C . This important result can be generalized to arbitrary dimensions, as we shall see below.

We have introduced Berry's phase by considering a unitary, cyclic and adiabatic evolution. This was Berry's original approach. It was generalized to the non-adiabatic case by Aharonov and Anandan (Y. Aharonov, 1987), as already said, and by Samuel and Bhandari (J. Samuel, 1988) to the noncyclic case. A purely kinematic approach showed that it is unnecessary to invoke unitarity of the evolution. Such an approach was developed by Mukunda and Simon (N. Mukunda, 1993) and is the subject of the next Section.

3. The kinematic approach: total, geometric, and dynamical phases

Let us start by considering a Hilbert space \mathcal{H} . We define $\mathcal{H}_0 \subset \mathcal{H}$ as the set of normalized, nonzero vectors $|\psi\rangle \in \mathcal{H}$. A curve \mathcal{C}_0 in \mathcal{H}_0 is defined through vectors $|\psi(s)\rangle$ that continuously depend on some parameter $s \in [s_1, s_2]$. Because $|\psi(s)\rangle$ is normalized, $\langle\psi(s)|\dot{\psi}(s)\rangle + \langle\dot{\psi}(s)|\psi(s)\rangle = 0$. Then, $\text{Re}\langle\psi(s)|\dot{\psi}(s)\rangle = 0$, and

$$\langle \psi(s) | \dot{\psi}(s) \rangle = i \text{Im} \langle \psi(s) | \dot{\psi}(s) \rangle. \quad (23)$$

Now, consider the initial $|\psi(s_1)\rangle$ and the end point $|\psi(s_2)\rangle$ of C_0 . Following Pancharatnam, we define the total phase between these states as $\Phi_{tot}(C_0) = \arg\langle \psi(s_1) | \psi(s_2) \rangle$. Under a gauge transformation $|\psi(s)\rangle \rightarrow |\psi'(s)\rangle = \exp(i\alpha(s)) |\psi(s)\rangle$, we have that $C_0 \rightarrow C'_0$, $\Phi_{tot}(C_0) \rightarrow \Phi'_{tot}(C_0) = \Phi_{tot}(C_0) + \alpha(s_2) - \alpha(s_1)$ and $\text{Im}\langle \psi(s) | \dot{\psi}(s) \rangle \rightarrow \text{Im}\langle \psi'(s) | \dot{\psi}'(s) \rangle = \text{Im}\langle \psi(s) | \dot{\psi}(s) \rangle + \dot{\alpha}(s)$. From these properties it is easy to see that we can construct the following quantity, the “geometric phase”, which is gauge-invariant:

$$\Phi_g(C_0) = \arg\langle \psi(s_1) | \psi(s_2) \rangle - \text{Im} \int_{s_1}^{s_2} \langle \psi(s) | \dot{\psi}(s) \rangle ds. \quad (24)$$

Besides being re-parametrization invariant, $\Phi_g(C_0)$ is, most importantly, also gauge invariant. This means that despite being defined in terms of $|\psi(s)\rangle$ and C_0 , Φ_g effectively depends on equivalence classes of $|\psi(s)\rangle$ and C_0 , respectively. Indeed, the set $\{|\psi'\rangle = \exp(i\alpha)|\psi\rangle\}$ constitutes an equivalence class. The space spanned by such equivalence classes is called the “ray space” \mathcal{R}_0 . Instead of working with equivalence classes we can work with projectors: $|\psi\rangle\langle\psi|$. The set $\{|\psi'\rangle = \exp(i\alpha)|\psi\rangle\}$ projects onto the object $|\psi\rangle\langle\psi|$ by means of a projection map $\pi : \mathcal{H}_0 \rightarrow \mathcal{R}_0$. In particular, the curves C_0, C'_0 which are interrelated by a gauge transformation, are also members of an equivalence class. Under π , they project onto a curve $C_0 \subset \mathcal{R}_0$. What we have seen above is that Φ_g is in fact a functional not of C_0 , but of C_0 , the curve defined by $|\psi(s)\rangle\langle\psi(s)|$. This is the reason why we call Φ_g the “geometric phase” associated with the curve $C_0 \subset \mathcal{R}_0$. We should then better write $\Phi_g(C_0)$, though its actual calculation requires that we choose what is called a “lift” of C_0 ; that is, any curve \tilde{C}_0 such that $\pi(\tilde{C}_0) = C_0$. Thus, $\Phi_g(C_0)$ is defined in terms of two phases, see Eq.(24):

$$\Phi_{tot}(C_0) = \arg\langle \psi(s_1) | \psi(s_2) \rangle, \quad (25)$$

$$\Phi_{dyn}(C_0) = \text{Im} \int_{s_1}^{s_2} \langle \psi(s) | \dot{\psi}(s) \rangle ds. \quad (26)$$

$\Phi_{tot}(C_0)$ is, as already said, the *total* or the Pancharatnam phase of C_0 . It is the argument α of the complex number $\langle \psi(s_1) | \psi(s_2) \rangle = |\langle \psi(s_1) | \psi(s_2) \rangle| e^{i\alpha}$. Later on, we will discuss the physical meaning of this phase in the context of polarized states, the case addressed by Pancharatnam. $\Phi_{dyn}(C_0)$ is the *dynamical phase* of C_0 . We see that even though both $\Phi_{tot}(C_0)$ and $\Phi_{dyn}(C_0)$ are functionals of C_0 , their difference Φ_g is a functional of $C_0 = \pi(C_0)$:

$$\Phi_g(C_0) = \Phi_{tot}(C_0) - \Phi_{dyn}(C_0). \quad (27)$$

Let us stress that this definition of the geometric phase does not rest on the assumptions originally made by Berry. $\Phi_g(C_0)$ has been introduced in terms of a given evolution of state vectors $|\psi(s)\rangle$. This evolution does not need to be unitary, nor adiabatic. Furthermore, the path C_0 could be open: no cyclic property is invoked. Given a $C_0 \subset \mathcal{R}_0$, we may choose different lifts to calculate $\Phi_g(C_0)$ and exploit this freedom to express $\Phi_g(C_0)$ according to our needs. For example, we can always make $\Phi_{tot}(C_0) = 0$, by properly choosing the phase of, say, $|\psi(s_2)\rangle$. In that case, $\Phi_g(C_0) = -\Phi_{dyn}(C_0)$. Alternatively, we can make $\Phi_{dyn}(C_0) = 0$, so that $\Phi_g(C_0) = \Phi_{tot}(C_0)$, by choosing a so-called “horizontal lift”, one which satisfies

$Im\langle\psi(s)|\dot{\psi}(s)\rangle = 0$. Because $Re\langle\psi(s)|\dot{\psi}(s)\rangle = 0$, in this case $\langle\psi(s)|\dot{\psi}(s)\rangle = 0$. In order to obtain a horizontal lift we can submit, if necessary, any lift $|\psi(s)\rangle$ to a gauge transformation: $|\psi(s)\rangle \rightarrow |\psi'(s)\rangle = \exp(i\alpha(s))|\psi(s)\rangle$, so that $Im\langle\psi(s)|\dot{\psi}(s)\rangle \rightarrow Im\langle\psi'(s)|\dot{\psi}'(s)\rangle = Im\langle\psi(s)|\dot{\psi}(s)\rangle + \dot{\alpha}(s)$. We then require $Im\langle\psi'(s)|\dot{\psi}'(s)\rangle = 0$, which yields

$$\alpha(s) = -Im \int_{s_1}^s \langle\psi(s)|\dot{\psi}(s)\rangle ds, \quad (28)$$

assuming $\alpha(s_1) = 0$, i.e., fixing $|\psi'(s_1)\rangle = |\psi(s_1)\rangle$ by proper choice of the initial phase. As $\Phi_g(C_0)$ depends only on ray-space quantities, it should be possible to get an expression reflecting this fact. Such an expression can be obtained by considering the operator $K(s) = \dot{\rho}(s) = d(|\psi(s)\rangle\langle\psi(s)|)/ds$, whose action on $|\psi(s)\rangle$ gives

$$K(s)|\psi(s)\rangle = |\dot{\psi}(s)\rangle - \langle\psi(s)|\dot{\psi}(s)\rangle|\psi(s)\rangle. \quad (29)$$

$K(s)$ is obviously gauge invariant; hence, Eq.(29) holds also for gauge-transformed quantities. By choosing a horizontal lift, $\langle\psi(s)|\dot{\psi}(s)\rangle = 0$, Eq.(29) reads

$$\frac{d}{ds}|\psi(s)\rangle = \dot{\rho}(s)|\psi(s)\rangle. \quad (30)$$

The solution of Eq.(30) can be formally given as a Dyson series: $|\psi(s)\rangle = P\left(\exp\int_{s_1}^s \dot{\rho}(s)ds\right)|\psi(s_1)\rangle$, with P the "parameter-ordering" operator: it rearranges a product of parameter-labelled operators according to, e. g., $P(\dot{\rho}(s_1)\dot{\rho}(s_2)\dot{\rho}(s_3)) = \dot{\rho}(s_3)\dot{\rho}(s_2)\dot{\rho}(s_1)$, for $s_3 \geq s_2 \geq s_1$. Having a horizontal lift, the geometric phase reduces to $\Phi_g(C_0) = \Phi_{tot}(C_0) = \arg\langle\psi(s_1)|\psi(s_2)\rangle$. Now, $\langle\psi(s_1)|\psi(s_2)\rangle = Tr|\psi(s_2)\rangle\langle\psi(s_1)|$, so that setting $|\psi(s_2)\rangle = P\left(\exp\int_{s_1}^{s_2} \dot{\rho}(s)ds\right)|\psi(s_1)\rangle$ we have

$$\Phi_g(C_0) = \arg Tr \left\{ P \left(\exp \int_{s_1}^{s_2} \dot{\rho}(s)ds \right) \rho(s_1) \right\}. \quad (31)$$

Eq.(31) gives the desired expression of $\Phi_g(C_0)$ in terms of ray-space quantities. C_0 is any smooth curve in ray space. If C_0 is closed, $\rho(s_2) = \rho(s_1)$, and $|\psi(s_2)\rangle$ must be equal to $|\psi(s_1)\rangle$ up to a phase factor: $|\psi(s_2)\rangle = e^{i\alpha}|\psi(s_1)\rangle$, with $\alpha = \arg\langle\psi(s_2)|\psi(s_1)\rangle$. For the horizontal lift we are considering, $\alpha = \arg\langle\psi(s_2)|\psi(s_1)\rangle = \Phi_g(C_0)$, and we can thus write

$$|\psi(s_2)\rangle = P \left(\exp \int_{s_1}^{s_2} \dot{\rho}(s)ds \right) |\psi(s_1)\rangle = \exp(i\Phi_g(C_0)) |\psi(s_1)\rangle, \quad (32)$$

in accordance with our previous results.

3.1 Geodesics

We introduce now the concept of geodesics in both Hilbert-space and ray-space, with the help of Eq.(29). Notice that $K(s)|\psi(s)\rangle$ is orthogonal to $|\psi(s)\rangle$, that is, $\langle\psi(s)|K(s)|\psi(s)\rangle = 0$. In general, $\langle\psi(s)|\dot{\psi}(s)\rangle \neq 0$; i.e., the curve $C_0 = \{|\psi(s)\rangle\}$ has a tangent vector $|\dot{\psi}(s)\rangle$ which is generally not orthogonal to C_0 . By letting $K(s)$ act on $|\psi(s)\rangle$ we get the component of $|\dot{\psi}(s)\rangle$ that is orthogonal to the curve. Such a component is obtained from $|\dot{\psi}(s)\rangle$ by subtracting its projection on $|\psi(s)\rangle$, i.e., we construct $|\dot{\psi}(s)\rangle - |\psi(s)\rangle\langle\psi(s)|\dot{\psi}(s)\rangle$. Let us denote this component by $|\dot{\psi}(s)\rangle_{\perp} = K(s)|\psi(s)\rangle$. Under a gauge transformation, $|\psi(s)\rangle \rightarrow |\psi'(s)\rangle = \exp(i\alpha(s))|\psi(s)\rangle$ and because $K'(s) = K(s)$, it follows $|\dot{\psi}'(s)\rangle_{\perp} = \exp(i\alpha(s))|\dot{\psi}(s)\rangle_{\perp}$. The

modulus of $|\dot{\psi}(s)\rangle_{\perp}$ is the quantity in terms of which we can define the “length” of a curve. To make our definition parameter invariant, we take the square root of said modulus and define the length of C_0 as

$$\mathcal{L}(C_0) = \int_{s_1}^{s_2} \sqrt{\langle \dot{\psi}(s) | \dot{\psi}(s) \rangle_{\perp}} ds. \quad (33)$$

Geodesics are defined as curves making $\mathcal{L}(C_0)$ extremal. By applying the tools of variational calculus one obtains (N. Mukunda, 1993)

$$\left(\frac{d}{ds} - \langle \psi(s) | \dot{\psi}(s) \rangle \right) \frac{|\dot{\psi}(s)\rangle_{\perp}}{\sqrt{\langle \dot{\psi}(s) | \dot{\psi}(s) \rangle_{\perp}}} = f(s) |\psi(s)\rangle, \quad (34)$$

with $f(s)$ an arbitrary, real function. Although Eq.(34) depends on the lifted curve C_0 , it must be gauge and re-parametrization invariant, because it follows from Eq.(33). We may therefore change both the lift and the parametrization in Eq.(34). We choose a horizontal lift: $\langle \psi(s) | \dot{\psi}(s) \rangle = 0$, which implies that $|\dot{\psi}(s)\rangle_{\perp} = |\dot{\psi}(s)\rangle$. Furthermore, because of re-parametrization freedom we may take s such that $\langle \dot{\psi}(s) | \dot{\psi}(s) \rangle$ is constant along C_0 . This fixes s up to linear inhomogeneous changes, i.e., up to affine transformations. Then, Eq.(34) reads

$$\frac{d^2}{ds^2} |\psi(s)\rangle = \sqrt{\langle \dot{\psi}(s) | \dot{\psi}(s) \rangle} f(s) |\psi(s)\rangle. \quad (35)$$

Now, by deriving twice the equation $\langle \psi(s) | \psi(s) \rangle = 1$, we obtain $\sqrt{\langle \dot{\psi}(s) | \dot{\psi}(s) \rangle} f(s) + \langle \dot{\psi}(s) | \dot{\psi}(s) \rangle = 0$, which fixes $f(s)$ to

$$f(s) = -\sqrt{\langle \dot{\psi}(s) | \dot{\psi}(s) \rangle}. \quad (36)$$

Thus, Eq.(35) reads finally

$$\frac{d^2}{ds^2} |\psi(s)\rangle = -\omega^2 |\psi(s)\rangle, \quad (37)$$

with $\omega^2 \equiv \langle \dot{\psi}(0) | \dot{\psi}(0) \rangle$. This equation holds for geodesics that are horizontal lifts from the geodesic C_0 in ray space, and with s rendering $\langle \dot{\psi}(s) | \dot{\psi}(s) \rangle$ constant. Eq.(37) is thus of second order and its general solution depends on two vectors. It can be solved, e.g., for the initial conditions $|\psi(0)\rangle = |\phi_1\rangle$ and $|\dot{\psi}(0)\rangle = \omega |\phi_2\rangle$, i.e., $\langle \phi_1 | \phi_1 \rangle = 1$, $\langle \phi_1 | \phi_2 \rangle = 0$, and $\langle \phi_2 | \phi_2 \rangle = 1$. The solution reads

$$|\psi(s)\rangle = \cos(\omega s) |\phi_1\rangle + \sin(\omega s) |\phi_2\rangle. \quad (38)$$

We see that $\langle \psi(0) | \psi(s) \rangle = \langle \phi_1 | \psi(s) \rangle = \cos(\omega s)$. Because s has been fixed only up to an affine transformation, we can generally choose it such that $\cos(\omega s) \geq 0$ for $s \in [s_1, s_2]$, so that $\arg\langle \psi(0) | \psi(s) \rangle = 0$. But because our lift is horizontal, $\Phi_g(C_0) = \arg\langle \psi(0) | \psi(s) \rangle$, so that

$$\Phi_g(C_0) = 0 \quad \text{for a geodesic } C_0. \quad (39)$$

Eq.(38) shows that geodesics are arcs of circles in a space with orthonormal basis $\{|\phi_1\rangle, |\phi_2\rangle\}$. We are thus effectively dealing with a two-level system. The geodesic $|\psi(s)\rangle$ of Eq.(38) projects onto a geodesic in ray-space $\rho(s) = |\psi(s)\rangle\langle\psi(s)|$. Last one can be mapped onto the unit sphere in a well-known manner. Indeed, for a two-level system, $\rho(s)$ has the form

$$\rho(s) = \frac{1}{2} (I + \vec{n}(s) \cdot \vec{\sigma}), \quad (40)$$

with I the identity matrix and $\vec{n} = \text{Tr}(\rho \vec{\sigma})$. Now, any two unit vectors, $|\psi_1\rangle$ and $|\psi_2\rangle$, can always be connected by a geodesic. To show this, we need only note that for any two vectors $|\psi_1\rangle$ and $|\psi_2\rangle$ there are two corresponding vectors \vec{n}_1 and \vec{n}_2 on the unit sphere. These points can be joined by the shortest of the two arcs conforming a great circle. This is the geodesic arc joining ρ_1 and ρ_2 that can be lifted to a geodesic arc joining $|\psi_1\rangle$ and $|\psi_2\rangle$. If necessary, we can submit this curve to a gauge transformation, thereby generally destroying its horizontal but not its geodesic property. Let us discuss this procedure in more detail. Consider two nonparallel vectors $|\psi_1\rangle, |\psi'_2\rangle$. They span a two-dimensional subspace in which we can consider an orthonormal basis $\{|\phi_1\rangle, |\phi_2\rangle\}$. For example, $|\phi_1\rangle = |\psi_1\rangle$ and $|\phi_2\rangle = (|\psi'_2\rangle - |\phi_1\rangle\langle\phi_1|\psi'_2\rangle) / \sqrt{1 - |\langle\phi_1|\psi'_2\rangle|^2}$. In such a basis, we can express $|\psi'_2\rangle$ in the form $|\psi'_2\rangle = e^{i\alpha}|\psi_2\rangle \equiv e^{i\alpha} [\cos(\theta/2)|\phi_1\rangle + e^{i\varphi} \sin(\theta/2)|\phi_2\rangle]$. We start by considering first the case in which the initial and final vectors are $|\phi_1\rangle = |\psi_1\rangle$ and $|\psi_2\rangle$, respectively. Thereafter, we deal with the more general case: $|\psi'_2\rangle = e^{i\alpha}|\psi_2\rangle$. The corresponding projectors $\rho_1 = |\psi_1\rangle\langle\psi_1|$ and $\rho_2 = |\psi_2\rangle\langle\psi_2|$ are given by expressions of the form of Eq.(40) with $\vec{n}_1 = (0, 0, 1)$ and $\vec{n}_2 = (\cos \varphi \sin \theta, \sin \varphi \sin \theta, \cos \theta)$. That is, \vec{n}_1 is the North pole (of the "Bloch sphere") and \vec{n}_2 has coordinates (θ, φ) . In order to bring \vec{n}_1 to \vec{n}_2 along a great circle we can submit \vec{n}_1 to a rotation around $\vec{n} = \vec{n}_1 \times \vec{n}_2 / \sin \theta$. The rotation from \vec{n}_1 to \vec{n}_2 takes $|\psi_1\rangle$ to $|\psi_2\rangle$ by a $SU(2)$ transformation: $U(\theta, \varphi) |\psi_1\rangle = |\psi_2\rangle$, with

$$U(\theta, \varphi) = \exp\left(-i\frac{\theta}{2}\vec{n} \cdot \vec{\sigma}\right) = \cos\left(\frac{\theta}{2}\right) I - i \sin\left(\frac{\theta}{2}\right) \vec{n} \cdot \vec{\sigma} = \cos\left(\frac{\theta}{2}\right) I - i \frac{\vec{n}_1 \times \vec{n}_2}{2 \cos(\theta/2)} \cdot \vec{\sigma}. \quad (41)$$

Setting $|\psi(s)\rangle = U(\theta s, \varphi)|\phi_1\rangle$ we have $|\psi(0)\rangle = |\psi_1\rangle, |\psi(1)\rangle = |\psi_2\rangle$, and the curve $|\psi(s)\rangle, s \in [0, 1]$, is a horizontal geodesic. Indeed, by explicitly writing $U(\theta s, \varphi)$ as

$$U(\theta s, \varphi) = \cos\left(\frac{\theta}{2}s\right) I - i \sin\left(\frac{\theta}{2}s\right) \vec{n}_\varphi \cdot \vec{\sigma}, \quad (42)$$

with $\vec{n}_\varphi = (-\sin \varphi, \cos \varphi, 0)$, we can straightforwardly verify that $|\psi(s)\rangle$ fulfills the defining properties of horizontal geodesics, namely $\langle\dot{\psi}(s)|\dot{\psi}(s)\rangle = 0$, and

$$\frac{d^2}{ds^2} |\psi(s)\rangle = -\langle\dot{\psi}(s)|\dot{\psi}(s)\rangle |\psi(s)\rangle = -\frac{\theta^2}{4} |\psi(s)\rangle. \quad (43)$$

Hence, we have proved that for $|\psi_1\rangle = |\phi_1\rangle$ and $|\psi_2\rangle = \cos(\theta/2)|\phi_1\rangle + e^{i\varphi} \sin(\theta/2)|\phi_2\rangle$, there is a horizontal geodesic $|\psi(s)\rangle = U(\theta s, \varphi)|\phi_1\rangle$ joining these vectors, with $U(\theta s, \varphi)$ as in Eq.(42). Next, we consider a general final vector $|\psi'_2\rangle = e^{i\alpha}|\psi_2\rangle$. In this case we need only change $U(\theta s, \varphi)$ by $e^{-i\alpha s}U(\theta s, \varphi)$ and it follows that the curve $|\psi'(s)\rangle = e^{-i\alpha s}U(\theta s, \varphi)|\phi_1\rangle$, with $|\psi'(0)\rangle = |\psi_1\rangle, |\psi'(1)\rangle = |\psi'_2\rangle$, is still a geodesic; that is, it satisfies Eq.(34) (with $f(s) = \theta/2$) though it is no longer horizontal: $\langle\psi'(s)|\dot{\psi}'(s)\rangle = -i\alpha$. In summary, we have proved that any two vectors, $|\psi_1\rangle$ and $|\psi_2\rangle$, can be connected by a geodesic \mathcal{C}_0 . If this geodesic happens to be horizontal, then its dynamical phase vanishes and so does its total phase $\arg\langle\psi_1|\psi_2\rangle$, see

Eq.(38). Hence, $\Phi_g(C_0) = 0$. This last property is gauge independent. However, if C_0 is not horizontal, then $\Phi_{dyn}(C_0) \neq 0$ and $\arg\langle\psi_1|\psi_2\rangle \neq 0$, but $\Phi_g(C_0) = 0$ anyway.

Eq.(39) leads to an alternative formulation of the geometric phase. It rests upon the concept of Bargmann invariants, for which Eq.(39) plays a central role, together with the total phase $\arg\langle\psi_1|\psi_2\rangle$. When $\arg\langle\psi_1|\psi_2\rangle = 0$ we say that $|\psi_1\rangle$ and $|\psi_2\rangle$ are “in phase”. This generalizes Pancharatnam’s definition for polarization states to the quantal case. As we have seen, $|\psi_1\rangle$ and $|\psi_2\rangle$ are “in phase” when these two vectors can be joined by a horizontal geodesic. Consider a third vector $|\psi_3\rangle$, joined to $|\psi_2\rangle$ by a horizontal geodesic, so that $\arg\langle\psi_2|\psi_3\rangle = 0$ too. Our three vectors are thus joined by a curve made of two geodesic arcs. Can we conclude that $|\psi_3\rangle$ and $|\psi_1\rangle$ are “in phase”? The answer is generally on the negative. Being “in phase” is not a transitive property. The following discussion illustrates this point.

3.2 Bargmann invariants

Consider N points in ray space: $\rho_1, \rho_2, \dots, \rho_N$. As we have seen, each pair can be connected by a geodesic arc. Let us denote by C_0 the curve formed by the $N - 1$ geodesic arcs joining the N points. Let us assume that any two neighboring points are nonorthogonal. That is, for any lift $|\psi_1\rangle, |\psi_2\rangle, \dots, |\psi_N\rangle$, it holds $\langle\psi_i|\psi_{i+1}\rangle \neq 0$, for $i = 1, \dots, N - 1$. The geometric phase $\Phi_g(C_0)$ is given by

$$\Phi_g(C_0) = \Phi_{tot}(C_0) - \Phi_{dyn}(C_0) = \arg\langle\psi_1|\psi_N\rangle - \sum_{k=1}^{N-1} \Phi_{dyn}^{(k,k+1)}, \quad (44)$$

where $\Phi_{dyn}^{(k,k+1)}$ is the dynamical phase for the geodesic joining $|\psi_k\rangle$ with $|\psi_{k+1}\rangle$. Because $\Phi_g^{(k,k+1)} = 0$, we can write $\Phi_{dyn}^{(k,k+1)} = \Phi_{tot}^{(k,k+1)} - \Phi_g^{(k,k+1)} = \arg\langle\psi_k|\psi_{k+1}\rangle$. Now, $\sum_{k=1}^{N-1} \arg\langle\psi_k|\psi_{k+1}\rangle = \arg\prod_{k=1}^{N-1} \langle\psi_k|\psi_{k+1}\rangle$, and $\arg\langle\psi_1|\psi_N\rangle = -\arg\langle\psi_N|\psi_1\rangle$, so that

$$\Phi_g(C_0) = \arg\langle\psi_1|\psi_N\rangle - \arg\prod_{k=1}^{N-1} \langle\psi_k|\psi_{k+1}\rangle = -\arg\left(\prod_{k=1}^{N-1} \langle\psi_k|\psi_{k+1}\rangle\right) \langle\psi_N|\psi_1\rangle, \quad (45)$$

and we can finally write

$$\Phi_g(C_0) = -\arg\langle\psi_1|\psi_2\rangle\langle\psi_2|\psi_3\rangle\dots\langle\psi_N|\psi_1\rangle. \quad (46)$$

Although $\Phi_g(C_0)$ has been derived by joining $|\psi_1\rangle, \dots, |\psi_N\rangle$ with geodesic arcs, the final expression does not depend on these arcs, but only on the vectors they join. Quantities like $\langle\psi_1|\psi_2\rangle\langle\psi_2|\psi_3\rangle\langle\psi_3|\psi_1\rangle$ are called “Bargmann invariants”. They generalize $|\langle\psi_1|\psi_2\rangle|^2$, which is invariant under simultaneous $U(1)$ transformations: $|\psi_1\rangle \rightarrow |\psi'_1\rangle = \exp(i\alpha_1)|\psi_1\rangle$ and $|\psi_2\rangle \rightarrow |\psi'_2\rangle = \exp(i\alpha_2)|\psi_2\rangle$. Quantities that are invariant under $U(1) \otimes U(1) \otimes \dots$ were introduced by Bargmann for studying the difference between unitary and anti-unitary transformations.

The curve C_0 in Eq.(45) was assumed to be open: $\rho_N \neq \rho_1$. However, we can close the curve to \tilde{C}_0 , by completing the $N - 1$ -sided polygon C_0 with a geodesic arc connecting ρ_N with ρ_1 . By repeating the steps leading to Eq.(45), though taking into account that now $\Phi_{tot}(\tilde{C}_0) = 0$ because the final point $|\psi_{N+1}\rangle = |\psi_1\rangle$, we see that $\Phi_g(\tilde{C}_0) = -\Phi_{dyn}(\tilde{C}_0) = -\arg\prod_{k=1}^N \langle\psi_k|\psi_{k+1}\rangle$, so that $\Phi_g(\tilde{C}_0)$ is given again by Eq.(46). In other words, $\Phi_g(\tilde{C}_0) = \Phi_g(C_0)$.

Starting from Eq.(46) it is possible to recover the results previously found for general open curves (N. Mukunda, 1993). One proceeds by approximating a given curve by a polygonal arc made up of $N \rightarrow \infty$ geodesic arcs. By a limiting procedure one recovers then $\Phi_g(C_0) = \Phi_{tot}(C_0) - \Phi_{dyn}(C_0)$ with $\Phi_{tot}(C_0)$ and $\Phi_{dyn}(C_0)$ given by Eqs.(25) and (26), respectively. Also Eq.(31) can be recovered in a similar fashion (N. Mukunda, 1993).

The quantity $\langle \psi_1 | \psi_3 \rangle \langle \psi_3 | \psi_2 \rangle \langle \psi_2 | \psi_1 \rangle$, the three-vertex Bargmann invariant, can be identified as the basic building block of geometric phases. It can be seen as the result of two successive filtering measurements, the first projecting $|\psi_1\rangle$ on $|\psi_2\rangle$, followed by a second projection on $|\psi_3\rangle$. The phase of the final state with respect to the first one is $\Phi_g^\Delta = -\arg\langle \psi_1 | \psi_2 \rangle \langle \psi_2 | \psi_3 \rangle \langle \psi_3 | \psi_1 \rangle = -\arg \text{Tr} \rho_1 \rho_2 \rho_3$. It can be proved (A. G. Wagh, 1999) that $\Phi_g^\Delta = -\Omega_p^\Delta / 2$. Here, Ω_p^Δ is the solid angle subtended by the spherical triangle formed by shorter geodesics between $|\psi_2\rangle$, $|\psi_3\rangle$ and the projection $|\psi_1\rangle^p$ of $|\psi_1\rangle$ on the subspace spanned by the other two vectors. Now, given a closed curve \tilde{C}_0 , by triangulation with infinitesimal geodesic triangles it is possible to express $\Phi_g(\tilde{C}_0)$ as (A. G. Wagh, 1999)

$$\Phi_g(\tilde{C}_0) = -\frac{1}{2} \int_S d\Omega_p, \quad (47)$$

thereby generalizing Eq.(22).

4. Pancharatnam-Berry phase and its measurement by polarimetry and interferometry

4.1 Interferometric arrangement

We introduced the total phase, $\arg\langle \psi_1 | \psi_2 \rangle$, as a generalization of Pancharatnam's definition for the relative phase between two polarized states of light. According to Pancharatnam's definition, we can operationally decide whether two nonorthogonal states are "in phase". Consider two nonorthogonal polarization states, $|i\rangle$ and $|f\rangle \neq |i\rangle$, and let them interfere. Due to the optical-path difference, there is a relative phase-shift ϕ giving rise to an intensity pattern

$$I = \left| e^{i\phi} |i\rangle + |f\rangle \right|^2 \propto 1 + |\langle i | f \rangle| \cos(\phi - \arg\langle i | f \rangle). \quad (48)$$

The maxima of I occur for $\phi = \arg\langle i | f \rangle \equiv \Phi_{tot}$, which is thereby operationally defined as the total (Pancharatnam) phase between $|i\rangle$ and $|f\rangle$. If $\arg\langle i | f \rangle = 0$, the states are said to be "in phase". Polarization states are two-level systems. When they are submitted to the action of intensity-preserving optical elements, like wave-plates, their polarization transformations belong to the group $SU(2)$ (modulo global phase factors). We can exhibit Φ_{tot} by submitting $|i\rangle$ to $U \in SU(2)$, thereby producing a state $|f\rangle = U|i\rangle$. Eq.(48) applies to, say, a Mach-Zehnder array. Alternatively, one could employ polarimetric methods. We will discuss both methods in what follows. Among the different parameterizations of U , the following one is particularly well suited for extracting Pancharatnam's phase:

$$U(\beta, \gamma, \delta) = \exp\left(i\left(\frac{\delta + \gamma}{2}\right)\sigma_z\right) \exp(-i\beta\sigma_y) \exp\left(i\left(\frac{\delta - \gamma}{2}\right)\sigma_z\right) = \begin{pmatrix} e^{i\delta} \cos \beta & -e^{i\gamma} \sin \beta \\ e^{-i\gamma} \sin \beta & e^{-i\delta} \cos \beta \end{pmatrix}. \quad (49)$$

Indeed, taking as initial state $|i\rangle = |+\rangle_z \equiv |+\rangle$, the eigenstate of σ_z for the eigenvalue $+1$, and setting $|f\rangle = U|+\rangle$, we obtain

$$\langle i|f\rangle = \langle +|U(\beta, \gamma, \delta)|+\rangle = e^{i\delta} \cos \beta. \quad (50)$$

Thus, $\Phi_{tot} = \arg \langle i|f\rangle = \delta + \arg(\cos \beta)$, for $\beta \neq (2n+1)\pi/2$. Because $\cos \beta$ takes on positive and negative real values, $\arg(\cos \beta)$ equals 0 or π , and Φ_{tot} is thus given by δ modulo π . In principle, then, we could obtain Φ_P (modulo π) by comparing two interferograms, one taken as a reference and corresponding to $\Phi_P = 0$ ($U = I$), and the other corresponding to the application of U . Their relative shift gives Φ_P . We can implement unitary transformations using quarter-wave plates (Q) and half-wave plates (H). These transformations are of the form $U(\xi, \eta, \zeta) = \exp(-i\xi\sigma_y/2) \exp(i\eta\sigma_z/2) \exp(-i\zeta\sigma_y/2)$. They can be realized with the following gadget (R. Simon, 1990), in which the arguments of Q and H mean the angles of their major axes to the vertical direction:

$$U(\xi, \eta, \zeta) = Q\left(\frac{-3\pi + 2\xi}{4}\right) H\left(\frac{\xi - \eta - \zeta - \pi}{4}\right) Q\left(\frac{\pi - 2\xi}{4}\right). \quad (51)$$

The corresponding interferogram has an intensity pattern given by

$$I_V = \frac{1}{2} \left[1 - \cos\left(\frac{\eta}{2}\right) \cos\left(\frac{\xi + \zeta}{2}\right) \cos(\phi) - \sin\left(\frac{\eta}{2}\right) \cos\left(\frac{\xi - \zeta}{2}\right) \sin(\phi) \right]. \quad (52)$$

I_V refers to an initial state $|+\rangle_z$ that is vertically polarized. This result follows from the parametrization of U given by $U(\xi, \eta, \zeta)$. By using the relationship between this parametrization and that of Eq.(49), i.e., $U(\beta, \gamma, \delta)$, one can show that I_V can be written as

$$I_V = \frac{1}{2} [1 - \cos \beta \cos(\phi - \delta)]. \quad (53)$$

Pancharatnam's phase $\Phi_P = \delta$ is thus given by the shift of the interferogram I_V with respect to a reference interferogram $I = [1 - \cos \beta \cos \phi] / 2$. By recording one interferogram after the other one could measure their relative shift. However, thermal and mechanical disturbances make it difficult to record stable reference patterns, thereby precluding accurate measurements of Φ_P . A way out of this situation follows from observing that the intensity pattern corresponding to an initial, horizontally polarized state $|-\rangle_z$ is given by

$$I_H = \frac{1}{2} [1 - \cos(\beta) \cos(\phi + \delta)]. \quad (54)$$

Hence, the relative shift between I_V and I_H is twice Pancharatnam's phase. If one manages to divide the laser beam into a vertically and a horizontally polarized part, the two halves of the laser beam will be subjected to equal disturbances and one can record two interferograms in a single shot. The relative shift would be thus easily measurable, being robust to thermal and mechanical disturbances. With such an array it is possible to measure Pancharatnam's phase for different unitary transformations. This approach proved to be realizable, using either a beam expander or a polarizing beam displacer (J. C. Loredó, 2009).

A similar approach can be used to measure the geometric phase $\Phi_g = \Phi_P(\mathcal{C}_0) - \Phi_{dyn}(\mathcal{C}_0)$. One can exploit the gauge freedom and choose an appropriate phase factor $\exp(i\alpha(s))$, so as to make $\Phi_{dyn}(\mathcal{C}_0) = 0$ along a curve $\mathcal{C}_0 : |\psi(s)\rangle$, $s \in [s_1, s_2]$ which is traced out by polarization states $|\psi(s)\rangle$ resulting from $U(s)$: $|\psi(s)\rangle = U(s)|\psi(0)\rangle$. Any $U(s)$ can be realized

by making one or more parameters in $U(\xi, \eta, \zeta)$ (see Eq.(51)) functions of s . Setting the corresponding QHQ -gadget on one arm of the interferometer, one lets the polarization state $|\psi(s)\rangle$ follow a prescribed curve. A second QHQ -gadget can be put on the other arm, in order to produce the factor $\exp(i\alpha(s))$ that is needed to make $\Phi_{dyn}(\mathcal{C}_0) = 0$. To fix $\alpha(s)$, one solves $\text{Im}\langle\psi(s)|\dot{\psi}(s)\rangle + \dot{\alpha}(s) = 0$. The corresponding interferometric setup is shown in Fig.(2). It is of the Mach-Zehnder type; but a Sagnac and a Michelson interferometer could be used as well. With the help of this array one can generate geometric phases associated to non-geodesic trajectories on the Poincaré sphere (J. C. Loredo, 2011). In this way, one is not constrained to use special trajectories, along which the dynamical phase identically vanishes (Y. Ota, 2009). The geometric phase is nowadays seen as an important tool for implementing robust quantum gates that can be employed in information processing (E. Sjöqvist, 2008). It appears to be noise resilient, as recent experiments seem to confirm (S. Fillip, 2009).

Ref.(J. C. Loredo, 2011) reports measurements that were obtained with a 30 mW cw He-Ne laser (632.8 nm) and the interferometric array shown in Fig.(2).The interferograms were

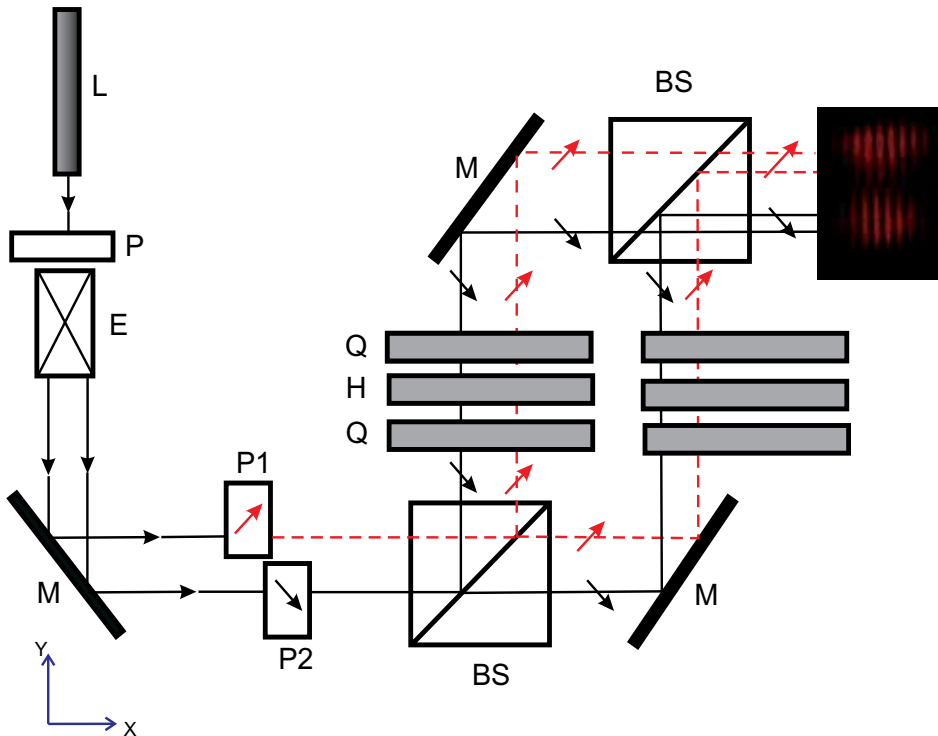

Fig. 2. Mach-Zehnder array for measuring the geometric phase. Quarter (Q) and half (H) wave plates are used for realizing the $SU(2)$ transformations. L: He-Ne laser, P, P₁, P₂: polarizers, E: beam expander, BS: beam-splitter, M: mirror.

recorded with the help of a CCD camera and evaluated using an algorithm that performs a column average of each half of the interferogram. The output was then submitted to a low-pass filter to get rid of noisy features. For each pair of curves the algorithm searches for relative minima and compares their locations. This procedure could be applied to a set

of interferograms corresponding to different choices of $U(\xi, \eta, \zeta)$. Experimental results are shown in Fig. (3), corresponding to the trajectory on the Poincaré sphere shown in Fig. (4). As can be seen, they are in very good agreement with theoretical predictions.

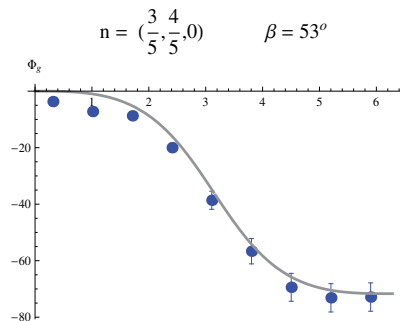

Fig. 3. Geometric phase for a non-geodesic trajectory on the Poincaré sphere. The trajectory is a circle resulting from intersecting a cone with the Poincaré sphere. It is fixed by the axis n of the cone and its aperture angle β .

4.2 Polarimetric arrangement

Some years ago, Wagh and Rakhecha proposed a polarimetric method to measure Pancharatnam’s phase (A. G. Wagh, 1995;b). Such a method is experimentally more demanding than the interferometric one, but it was considered more accurate because it requires a single beam. Both methods were tested in experiments with neutrons (A. G. Wagh, 1997; 2000), whose spins were subjected to $SU(2)$ transformations by applying a magnetic field. Now, it is not obvious that one can extract phase information from a single beam. As we shall see, polarimetry can be understood as “virtual interferometry”, in which a single beam is decomposed in two “virtual” beams.

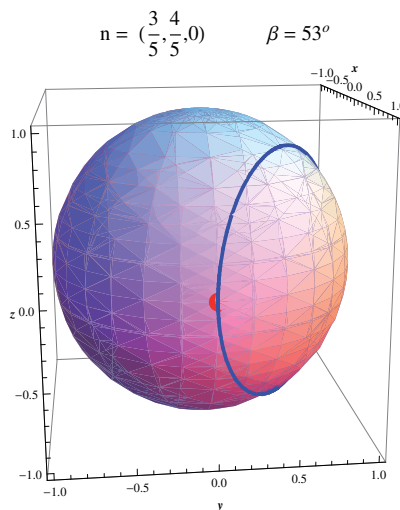

Fig. 4. The trajectory described on the Poincaré sphere. The dynamical phase is simultaneously cancelled by means of a QHQ gadget.

Consider an initial state $|+\rangle \equiv |+\rangle_z$ and let it be submitted to a $\pi/2$ -rotation around the x -axis to produce the circularly polarized state $(|+\rangle - i|-\rangle)/\sqrt{2}$, which is in turn acted upon by $\exp(-i\phi\sigma_z/2)$. The result is $V|+\rangle \equiv \exp(-i\phi\sigma_z/2)\exp(-i\pi\sigma_x/4)|+\rangle$, i.e., the state $(|+\rangle - ie^{i\phi}|-\rangle)/\sqrt{2}$, up to a global phase. We have thereby generated a relative phase-shift ϕ between $|+\rangle$ and $|-\rangle$, as in an interferometer. Applying $U \in SU(2)$ we obtain $UV|+\rangle = e^{-i\phi/2}(U|+\rangle - ie^{i\phi}U|-\rangle)/\sqrt{2} \equiv |\chi_+\rangle + |\chi_-\rangle$. From this state we will extract Pancharatnam's phase. To this end, we project with $V|+\rangle$, so that the intensity of the projected state is

$$I = \left| \langle + | V^\dagger (|\chi_+\rangle + |\chi_-\rangle) \right|^2. \quad (55)$$

Let us write $V|+\rangle = e^{-i\phi/2}(|+\rangle - ie^{i\phi}|-\rangle)/\sqrt{2} \equiv |\varphi_+\rangle + |\varphi_-\rangle$ and take U as given by Eq.(49). Calculating the amplitude $\langle + | V^\dagger (|\chi_+\rangle + |\chi_-\rangle) = (\langle \varphi_+ | + \langle \varphi_- |)(|\chi_+\rangle + |\chi_-\rangle)$ we obtain, using $\langle \varphi_\pm | \chi_\pm \rangle = \exp(\pm i\delta) \cos(\beta)/2$, and $\langle \varphi_\mp | \chi_\pm \rangle = i \exp(\mp i(\gamma + \phi)) \sin(\beta)/2$, that $(\langle \varphi_+ | + \langle \varphi_- |)(|\chi_+\rangle + |\chi_-\rangle) = \cos(\beta) \cos(\delta) + i \sin(\beta) \cos(\gamma + \phi)$ and

$$I = \cos^2(\beta) \cos^2(\delta) + \sin^2(\beta) \cos^2(\gamma + \phi). \quad (56)$$

Eq.(56) contains Pancharatnam's phase $\delta = \Phi_{tot}$. It can be extracted from intensity measurements. Indeed, Eq.(56) yields the minimal and maximal intensity values of the pattern that arises from varying ϕ . They are given by $I_{min} = \cos^2(\beta) \cos^2(\delta)$ and $I_{max} = \cos^2(\beta) \cos^2(\delta) + \sin^2(\beta)$, respectively, so that Pancharatnam's phase follows from

$$\cos^2(\delta) = \frac{I_{min}}{1 - I_{max} + I_{min}}. \quad (57)$$

In order to measure the geometric phase, we make $\Phi_{dyn} = 0$. As we saw before, this can be achieved by using in place of the gauge $|\psi(s)\rangle = U(s)|+\rangle$, the gauge $|\psi(s)\rangle = \exp[i\alpha(s)]U(s)|+\rangle$. In this way we get $\langle \psi(s) | d\psi(s)/ds \rangle = 0$, so that $\Phi_{tot} = \Phi_g$. To be specific, let us assume that we wish to generate circular trajectories corresponding to rotations by an angle s around $\vec{n}(\theta, \varphi)$. The corresponding unitarity is $U(\theta, \varphi, s) = \exp[-is\vec{n}(\theta, \varphi) \cdot \vec{\sigma}]$. In order to make $\Phi_{dyn}(\mathcal{C}_0) = 0$ in this case, we can take $\alpha(s) = \langle + | \vec{n}(\theta, \varphi) \cdot \vec{\sigma} | + \rangle s$.

In an optical arrangement we implement V and U with retarders. Simon and Mukunda (R. Simon, 1989) proposed a gadget realizing $U(\theta, \varphi, s)$, so that the circular trajectory is generated by rotating a single retarder (H) by the angle $s/2$, after having fixed θ and φ . This gadget is

$$U(\theta, \varphi, s) = Q\left(\frac{\pi + \varphi}{2}\right) Q\left(\frac{\theta + \varphi}{2}\right) H\left(\frac{-\pi + \theta + \varphi}{2} + \frac{s}{2}\right) Q\left(\frac{\theta + \varphi}{2}\right) Q\left(\frac{\varphi}{2}\right). \quad (58)$$

As for $V = \exp(-i\phi\sigma_z/2)\exp(-i\pi\sigma_x/4)$, we have $\exp(-i\pi\sigma_x/4) = Q(\pi/4)$ and $\exp(-i\phi\sigma_z/2) = Q(\pi/4)H((\phi - \pi)/4)Q(\pi/4)$. Using $Q^2(\pi/4) = H(\pi/4)$ and $\exp(+i\phi\sigma_z/2) = Q(-\pi/4)H((\phi + \pi)/4)Q(-\pi/4)$ we get

$$U_{tot} \equiv V^\dagger UV = H\left(-\frac{\pi}{4}\right) H\left(\frac{\phi + \pi}{4}\right) Q\left(-\frac{\pi}{4}\right) U Q\left(\frac{\pi}{4}\right) H\left(\frac{\phi - \pi}{4}\right) H\left(\frac{\pi}{4}\right). \quad (59)$$

Inserting for U the corresponding operator, which in the present case is $\exp[i\alpha(s)]U(\theta, \varphi, s)$, we obtain the full arrangement. Applying relations like $Q(\alpha)H(\beta) = H(\beta)Q(2\beta - \alpha)$,

$Q(\alpha)H(\beta)H(\gamma) = Q(\alpha + \pi/2)H(\alpha - \beta + \gamma - \pi/2)$, etc. (R. Simon, 1990), we can reduce the array from elf to seven retarders:

$$U_{tot}(\theta, \varphi, s, \gamma) = Q\left(\frac{\pi}{4} - \frac{\gamma}{2}\right) Q\left(-\pi - \frac{\varphi}{2} - \frac{\gamma}{2}\right) Q\left(\frac{\pi - \theta - \varphi}{2} - \frac{\gamma}{2}\right) \times \quad (60)$$

$$\times H\left(\frac{-s - \theta - \varphi}{2} - \frac{\gamma}{2}\right) Q\left(\frac{\pi - \theta - \varphi}{2} - \frac{\gamma}{2}\right) Q\left(\frac{\pi - \varphi}{2} - \frac{\gamma}{2}\right) Q\left(-\frac{\pi}{4} - \frac{\gamma}{2}\right),$$

with $\gamma \equiv \sigma + \alpha(s) = \sigma + s \sin \theta \cos \varphi$. For each fixed value of s – that is, for each point on the chosen trajectory – one generates an intensity pattern through variation of σ , i.e., by rotating the whole array σ radians over some interval, which should be large enough for recording several maximal and minimal intensity values. From these values one can obtain $\Phi_g(s)$. Indeed, the intensity is given by $I = |\langle + | U_{tot} | + \rangle|^2$, and it can be proved (J. C. Loredó, 2011) that in the present case $I = \cos^2(s) + \sin^2(s) [\cos(\theta) \cos(\sigma - \alpha(s)) - \sin(\theta) \sin(\varphi) \sin(\sigma - \alpha(s))]^2$. From this result one derives the following expression for the geometric phase (J. C. Loredó, 2011):

$$\Phi_g(s) = \arccos\left(\sqrt{I_{\min}}\right) \sqrt{\frac{1 - I_{\max}}{1 - I_{\min}}} - \arctan\left(\sqrt{\frac{1 - I_{\max}}{I_{\min}}}\right). \quad (61)$$

This result has been tested for various trajectories (J. C. Loredó, 2011), confirming theoretical predictions with the expected accuracy. Though all these experiments were performed with a cw He-Ne laser, an alternative setting using single-photon sources should produce similar results. This is so because all the aforementioned results have topological, rather than classical or quantal character.

5. Geometric phase for mixed states

Up to this point, the geometric phase refers to pure states $\rho = |\psi\rangle\langle\psi|$. It is natural to ask whether geometric phases can be defined for mixed states as well. Uhlmann addressed this question (A. Uhlmann, 1986) and introduced a phase based on the concept of parallel transport. When a pure state $|\psi(s)\rangle$ evolves under parallel transport, it remains in phase with $|\psi(s + ds)\rangle$, i.e., the system does not suffer local phase changes. After completing a closed loop, a state may acquire a nontrivial phase, stemming from the curvature of the underlying parameter space. This notion can be extended to mixed states. To this end, Uhlmann considered so-called “purifications” of mixed states. That is, one considers a mixed state as being part of a larger system, which is in a pure state. There are infinitely many possible purifications of a given mixed state. Hence, to a given cyclic evolution there correspond infinitely many evolutions of the purifications. However, one of these evolutions can be singled out as the one which is “maximally parallel” (A. Uhlmann, 1986), and this leads to a definition of geometric phases for mixed states.

An alternative approach was addressed more recently by Sjöqvist *et al.* (E. Sjöqvist, 2000). The starting point is Pancharatnam’s approach; i.e., the interference between two states: $|i\rangle$, to which a phase-shift ϕ is applied, and $|f\rangle = U|i\rangle$, with U unitary. The interference pattern is given by

$$I = \left| e^{i\phi} |i\rangle + U |i\rangle \right|^2 = 2 + 2 |\langle i|U|i\rangle| \cos(\phi - \arg\langle i|U|i\rangle) = 2 + 2v \cos(\phi - \Phi_{tot}), \quad (62)$$

with $v = |\langle i|U|i\rangle|$ being the visibility and $\Phi_{tot} = \arg\langle i|U|i\rangle$ the total phase between $|i\rangle$ and $U|i\rangle$.

Consider now a mixed state $\rho = \sum_i w_i |i\rangle\langle i|$, with $\sum_i w_i = 1$. The intensity profile will now be given by the contributions of all the individual pure states:

$$I = \sum_i w_i \left| e^{i\phi} |i\rangle + U |i\rangle \right|^2 = 2 + 2 \sum_i w_i |\langle i|U|i\rangle| \cos(\phi - \arg\langle i|U|i\rangle). \quad (63)$$

We can write I in a basis-independent form as (E. Sjöqvist, 2000)

$$I = 2 + 2 |\text{Tr}(U\rho)| \cos[\phi - \arg \text{Tr}(U\rho)]. \quad (64)$$

It is then clear that $v = |\text{Tr}(U\rho)|$ and that the total phase can be operationally defined as $\Phi_{tot} = \arg \text{Tr}(U\rho)$, which is the value of the shift ϕ at which maximal intensity is attained. As expected, such a definition reduces to Pancharatnam's for pure states $\rho = |i\rangle\langle i|$.

Let us now address the extension of the *geometric* phase for mixed states. For pure states $|\psi(s)\rangle$ the geometric phase equals Pancharatnam's phase whenever $|\psi(s)\rangle$ evolves under parallel transport: $\langle \psi(s) | \dot{\psi}(s) \rangle = 0$. We can try to extend the notion of parallel transport for mixed states by requiring $\rho(s)$ to be in phase with $\rho(s+ds) = U(s+ds) \rho_0 U^\dagger(s+ds) = U(s+ds) U^\dagger(s) \rho(s) U(s) U^\dagger(s+ds)$. According to our previous definition, the phase difference between $\rho(s)$ and $\rho(s+ds)$ is given by $\arg \text{Tr}(U(s+ds) U^\dagger(s) \rho(s))$ in this case. We say that $\rho(s)$ and $\rho(s+ds)$ are in phase when $\arg \text{Tr}(U(s+ds) U^\dagger(s) \rho(s)) = 0$, i.e., $\text{Tr}(U(s+ds) U^\dagger(s) \rho(s))$ is a positive real number. Now, because $\text{Tr}(\rho(s)) = 1$ and $\rho(s)^\dagger = \rho(s)$, the number $\text{Tr}(\dot{U} U^\dagger \rho)$ is purely imaginary. Hence, a necessary condition for parallel transport is

$$\text{Tr}(\dot{U}(s) U^\dagger(s) \rho(s)) = 0. \quad (65)$$

However, such a condition is not sufficient to fix $U(s)$ for a given $\rho(s)$. Indeed, considering any $N \times N$ matrix representation of the given ρ , Eq.(65) determines U only up to N phase factors. In order to fix these factors we must impose a more stringent condition:

$$\langle k(s) | \dot{U}(s) U^\dagger(s) | k(s) \rangle = 0, \quad k = 1, \dots, N, \quad (66)$$

where $\rho(s) = \sum_k w_k |k(s)\rangle\langle k(s)|$. This gives the desired generalization of parallel transport to the case of mixed states. We can now define a geometric phase for a state that evolves along the curve $C: s \rightarrow \rho(s) = U(s) \rho_0 U^\dagger(s)$, with $s \in [s_1, s_2]$ and $U(s)$ satisfying Eqs.(65) and (66). The dynamical phase $\Phi_{dyn} \equiv -i \int_{s_1}^{s_2} ds \text{Tr}(U^\dagger(s) \dot{U}(s) \rho(0)) = 0$ and we define the geometric phase Φ_g for mixed states as

$$\Phi_g = \arg \text{Tr}(U(s) \rho(0)). \quad (67)$$

Φ_g is gauge and parametrization invariant and has been defined for general paths, open or closed. In special cases, Φ_g can be expressed in terms of a solid angle, as it is the case with Berry's phase. For example, a two-level system can be described by

$$\rho = \frac{1}{2} (I + \vec{r} \cdot \vec{\sigma}) = \frac{1}{2} (I + r \vec{n} \cdot \vec{\sigma}), \quad (68)$$

with $\vec{n} \cdot \vec{n} = 1$ and r constant for unitary evolutions. For pure states $r = 1$, while for mixed states $r < 1$. The unitary evolution of $\rho(s)$ makes $\vec{n}(s)$ to trace out a curve C on the Bloch sphere. If necessary, we close C to \tilde{C} by joining initial and final points with a geodesic arc, so that \tilde{C} subtends a solid angle Ω . Then, the two eigenstates $|\pm; \vec{n} \cdot \vec{\sigma}\rangle$ of $\vec{n} \cdot \vec{\sigma}$ acquire geometric phases $\mp\Omega/2$. Both states have the same visibility $v_0 = |\langle \pm; \vec{n} \cdot \vec{\sigma} | U | \pm; \vec{n} \cdot \vec{\sigma} \rangle|$. The eigenvalues of ρ are $w_{\pm} = (1 \pm r)/2$. The geometric phase thus reads

$$\Phi_g = \arg \left(\frac{1+r}{2} e^{-i\Omega/2} + \frac{1-r}{2} e^{+i\Omega/2} \right) = -\arctan \left(r \tan \left(\frac{\Omega}{2} \right) \right). \quad (69)$$

and the visibility

$$v = v_0 \left| \frac{1+r}{2} e^{-i\Omega/2} + \frac{1-r}{2} e^{+i\Omega/2} \right| = v_0 \sqrt{\cos^2 \left(\frac{\Omega}{2} \right) + r^2 \sin^2 \left(\frac{\Omega}{2} \right)}. \quad (70)$$

Eqs.(69) and (70) reduce for $r = 1$ to $\Phi_g = -\Omega/2$ and $v = v_0$, respectively, the known expressions for pure states. For maximally mixed states, $r = 0$, we obtain $\Phi_g = \arg \cos(\Omega/2)$, $v = |\cos(\Omega/2)|$, and Eq.(64) yields

$$I = 2 + 2 |\cos(\Omega/2)| \cos(\phi - \arg \cos(\Omega/2)) = 2 + 2 \cos(\Omega/2) \cos \phi. \quad (71)$$

We see that for $\Omega = 2\pi$ there is a sign change in the intensity pattern. This was experimentally observed in early experiments testing the 4π symmetry of spin-1/2 particles (H. Rauch, 1975). Much later, theoretical results like those expressed in Eqs.(69,70) have been successfully put to experimental test (M. Ericsson, 2005).

The above extensions of Pancharatnam's and geometric phases assume a unitary evolution $|i\rangle \rightarrow |f\rangle = U|i\rangle$. A non-unitary evolution – reflecting the influence of an environment – can be handled with the help of an ancilla; that is, by replacing the true environment by an environment simulator, a fictitious system being in a pure state $|0_e\rangle\langle 0_e|$, which is appended to the given system. The system plus the environment simulator are then described by $\tilde{\rho} = \rho \otimes |0_e\rangle\langle 0_e|$ and evolve unitarily, $\tilde{\rho} \rightarrow \tilde{\rho}' = U\tilde{\rho}U^\dagger$, in such a way that by tracing over the environment we recover the change of $\rho \rightarrow \rho' = Tr_e \tilde{\rho}'$. Introducing an orthonormal basis $\{|k_e\rangle\}_{k=0,\dots,M}$ for the environment, we can write $Tr_e \tilde{\rho}' = \sum_k K_k \rho K_k^\dagger$, with $K_k \equiv \langle k_e | U | 0_e \rangle$ being so-called Kraus operators (S. Haroche, 2007). Using these tools it is possible to extend total and geometric phases to non-unitary evolutions (J. G. Peixoto, 2002).

6. Thomas rotation in relativity and in polarization optics

In this closing Section we address a well-known effect of special relativity, Thomas rotation, and show its links to geometric phases. We recall that Thomas rotation is a rather surprising effect of Lorentz transformations. These transformations connect to one another the coordinates of two inertial systems, O and O' , by $x'^\mu \rightarrow x^\mu = \Lambda_\nu^\mu x'^\nu$, with $\Lambda_\nu^\mu \eta_{\mu\tau} \Lambda_\sigma^\tau = \eta_{\nu\sigma}$. Here, $\eta_{\mu\nu}$ denotes the Minkowsky metric tensor. Lorentz transformations form a six-parameter Lie group, whose elements can be written as (J. D. Jackson, 1975) $\Lambda = \exp L$, with $L = -\vec{\omega} \cdot \vec{S} - \vec{\zeta} \cdot \vec{K}$. The matrices \vec{S} and \vec{K} are the group generators, while

$\vec{\omega} = (\omega_1, \omega_2, \omega_3)$ and $\vec{\zeta} = (\zeta_1, \zeta_2, \zeta_3)$ are six parameters, those required to fix any group element. The generators form an algebra, the Lie algebra of the group, which in the present case is defined through the following commutators:

$$[S_i, S_j] = \epsilon_{ijk} S_k, \quad (72)$$

$$[S_i, K_j] = \epsilon_{ijk} K_k, \quad (73)$$

$$[K_i, K_j] = -\epsilon_{ijk} S_k \quad (74)$$

In Eq.(72) we recognize the generators of the rotation group. On the other hand, the K_i are generators of “boosts” connecting two systems that move with uniform relative velocity and parallel axes. Intuitively, if O and O' are related by a boost, and so also O' and O'' , then we expect that the same holds true for the transformation relating O and O'' . The surprising discovery of Thomas was that this is not the case. Having parallel axes is not a transitive property within the framework of Lorentz transformations. The product of two boosts is not a boost, but it is instead a product of a boost by a rotation, the Thomas rotation. As almost all relativistic effects, in order to exhibit Thomas rotation we should consider systems whose relative velocity is near the velocity of light. Otherwise, the effect is too small to be observed. However, there is an equivalent effect that appears in the context of geometric phases, whose observation might be realizable with standard equipment. The root of Thomas rotation is the non-transitive property of boosts. As we have seen, Pancharatnam’s connection relates also in a non-transitive way two polarization states. Intensity-preserving transformations of these states form a representation of the rotation group $SU(2)$. But these are only particular transformations among others, more general ones, which include intensity non-preserving transformations. The latter can be realized with the help of, e.g., polarizers, that is, *dichroich* optical elements. These elements provide us with the necessary tools for studying Thomas rotations.

Before we discuss the optical framework, we need some more algebra to build the bridge connecting Lorentz and polarization transformations. To this end, we recall the Dirac equation (J. D. Bjorken, 1964):

$$(i\gamma^\mu \partial_\mu - m)\psi(x) = 0, \quad (75)$$

with $\psi(x)$ denoting a bi-spinor and the γ^μ being the Dirac matrices: $\gamma^\mu \gamma^\nu + \gamma^\nu \gamma^\mu = 2\eta^{\mu\nu}$. Bi-spinor space can be used as a representation-space for the Lorentz group. The Lorentz transformation $\Lambda = \exp L$, which acts in space-time, has a corresponding representation in bi-spinor space that is given by (J. D. Bjorken, 1964)

$$S(\Omega_{\mu\nu}) = \exp\left(-\frac{1}{4}\Omega_{\mu\nu}\gamma^\mu\gamma^\nu\right), \quad (76)$$

with $\Omega_{\mu\nu}(\Lambda) = -\Omega_{\nu\mu}(\Lambda)$ constituting six independent parameters. The commutation properties of the γ^μ allow us to write $S(\Omega_{\mu\nu})$ in terms of Pauli matrices $\vec{\sigma}$. This is so because $S(\Omega_{\mu\nu})$ contains only even products of the γ^μ matrices. Such products conform a subalgebra of the γ^μ , which is isomorphic to the Pauli-algebra. We can then map each 4×4 matrix $S(\Omega_{\mu\nu})$ into a 2×2 matrix

$$T(\vec{\alpha}, \vec{\beta}) = \exp \left[\left(\vec{\alpha} + i \vec{\beta} \right) \cdot \vec{\sigma} \right]. \quad (77)$$

We see that $T(\vec{\alpha}, \vec{\beta})$ is like an element of $SU(2)$, $\exp(i \vec{\delta} \cdot \vec{\sigma})$, but with $\vec{\delta}$ being replaced by a complex three vector $\vec{\alpha} + i \vec{\beta}$ that entails the six real parameters of the Lorentz group. The representation of this group as in Eq.(77) is what we need to establish a connection with polarization optics.

A monochromatic, polarized, plane wave can be represented by Jones vectors with complex components: $|\pi\rangle = \left(\cos \chi, e^{i\phi} \sin \chi \right)^T$. Alternatively, polarization states can be represented by four-component Stokes vectors (s_0, \vec{s}) , corresponding to a representation of pure states by density operators:

$$\rho = |\pi\rangle \langle \pi| = \frac{1}{2} (I + \vec{s} \cdot \vec{\sigma}). \quad (78)$$

In general, the Stokes four-vector $(s_0, \vec{s}) = (Tr\rho, Tr(\rho\sigma_1), Tr(\rho\sigma_2), Tr(\rho\sigma_3))$. The Stokes three-vector \vec{s} that corresponds to the Jones vector $|\pi\rangle = \left(\cos \chi, e^{i\phi} \sin \chi \right)^T$ is given by $\vec{s} = (\cos(\phi) \sin(2\chi), \sin(\phi) \sin(2\chi), \cos(2\chi))$. Vectors \vec{s} span the Poincaré-Bloch sphere. Intensity preserving transformations, like those realized by wave plates, are represented by 2×2 matrices belonging to the $SU(2)$ group. The effect of such a matrix on \vec{s} is to rotate this vector without changing its length. By applying $U = \exp(i\Phi \vec{n} \cdot \vec{\sigma} / 2)$ to an input vector $|\pi_i\rangle$ we obtain an output vector $|\pi_o\rangle = U |\pi_i\rangle$. The corresponding Stokes vectors, \vec{s}_i and \vec{s}_o , are related to one another by the well-known Rodrigues formula (H. Goldstein, 1980) that gives a rotated vector in terms of the rotation angle Φ and axis \vec{n} :

$$\vec{s}_o = \cos(\Phi) \vec{s}_i + [1 - \cos(\Phi)] (\vec{n} \cdot \vec{s}_i) \vec{n} + \sin(\Phi) \vec{s}_i \times \vec{n}. \quad (79)$$

Consider now dichroic optical elements, e.g., a non-ideal polarizer. To encompass optical conventions we use in what follows the Pauli matrices: $\rho_1 = \sigma_3, \rho_2 = \sigma_1, \rho_3 = \sigma_2$. In such a representation $|\pi\rangle = \left(\cos \chi, e^{i\phi} \sin \chi \right)^T$ is x -polarized when $\chi = 0$ and y -polarized when $\chi = \pi/2$. The matrix representing a non-ideal polarizer whose lines of maximal and minimal transmission are along the x - and y -polarization axes, respectively, is given by

$$J_{diag} = \begin{pmatrix} p_x & 0 \\ 0 & p_y \end{pmatrix}. \quad (80)$$

The eigenvectors of J_{diag} , $(1, 0)^T$ and $(0, 1)^T$, are thus polarization vectors along the x and $-x$ directions, respectively, on the Poincaré sphere. The corresponding matrix whose eigenvectors are $|\pi_1\rangle = \left(\cos \chi, e^{i\phi} \sin \chi \right)^T$ and its orthogonal $|\pi_2\rangle = \left(-e^{-i\phi} \sin \chi, \cos \chi \right)^T$, is given by

$$J = \left(\frac{p_x + p_y}{2} \right) I + \left(\frac{p_x - p_y}{2} \right) [(\cos 2\chi) \rho_1 + (\sin 2\chi \cos \phi) \rho_2 + (\sin 2\chi \sin \phi) \rho_3]. \quad (81)$$

Taking x as transmission axis ($p_x > p_y$), writing $p_x = e^{-\alpha_m}$, $p_y = e^{-\alpha_M}$ and setting $\vec{\Gamma} = (\cos 2\chi, \sin 2\chi \cos \phi, \sin 2\chi \sin \phi)$, we obtain, with $\alpha_s = \alpha_m + \alpha_M$ and $\alpha_d = \alpha_M - \alpha_m$,

$$J = \exp\left(-\frac{\alpha_s}{2}\right) \left\{ \cosh\left(\frac{\alpha_d}{2}\right) I + \sinh\left(\frac{\alpha_d}{2}\right) \vec{f} \cdot \vec{\rho} \right\}. \quad (82)$$

We can show that Eq.(77) is just of this form. To this end, we write $T(\vec{\alpha}, \vec{\beta}) = \exp(-\vec{f} \cdot \vec{\rho})$, with $\vec{f} = \vec{\alpha} + i\vec{\beta}$, and observe that $\vec{f} \cdot \vec{\rho}$ has eigenvalues

$$\lambda_{\pm} = \pm \sqrt{\vec{\alpha}^2 - \vec{\beta}^2 + 2i\vec{\alpha} \cdot \vec{\beta}} \equiv \pm z. \quad (83)$$

Denoting by $|\mathbf{f}_{\pm}\rangle$ the eigenvectors of $\vec{f} \cdot \vec{\rho}$; that is, $\vec{f} \cdot \vec{\rho} |\mathbf{f}_{\pm}\rangle = \lambda_{\pm} |\mathbf{f}_{\pm}\rangle$, we have $I = |\mathbf{f}_+\rangle \langle \mathbf{f}_+| + |\mathbf{f}_-\rangle \langle \mathbf{f}_-|$ and $\vec{f} \cdot \vec{\rho} = \lambda_+ |\mathbf{f}_+\rangle \langle \mathbf{f}_+| + \lambda_- |\mathbf{f}_-\rangle \langle \mathbf{f}_-|$. Solving for $|\mathbf{f}_{\pm}\rangle \langle \mathbf{f}_{\pm}|$ we obtain

$$|\mathbf{f}_{\pm}\rangle \langle \mathbf{f}_{\pm}| = \frac{zI \pm \vec{f} \cdot \vec{\rho}}{2z}. \quad (84)$$

Using $\exp A = \sum_n \exp a_n |a_n\rangle \langle a_n|$ with $A = -\vec{f} \cdot \vec{\rho}$ and observing that $\exp(-\vec{f} \cdot \vec{\rho})$ has eigenvectors $|\mathbf{f}_{\pm}\rangle$ and eigenvalues $\exp(\mp z)$, we get

$$\begin{aligned} \exp(-\vec{f} \cdot \vec{\rho}) &= e^{-z} |\mathbf{f}_+\rangle \langle \mathbf{f}_+| + e^z |\mathbf{f}_-\rangle \langle \mathbf{f}_-| = \frac{e^{-z}}{2z} (zI + \vec{f} \cdot \vec{\rho}) + \frac{e^z}{2z} (zI - \vec{f} \cdot \vec{\rho}) \\ &= \left(\frac{e^z + e^{-z}}{2}\right) I - \left(\frac{e^z - e^{-z}}{2z}\right) \vec{f} \cdot \vec{\rho} \\ &= (\cosh z) I - \sinh z \left(\frac{\vec{f}}{z}\right) \cdot \vec{\rho} \end{aligned} \quad (85)$$

It is easy to show from Eq.(85) that a Lorentz transformation $\exp(-\vec{f} \cdot \vec{\rho})$ can generally be written as a product of a boost by a rotation. It is clear from Eq.(77) that a rotation is obtained when $\vec{\alpha} = \vec{0}$ and a boost when $\vec{\beta} = \vec{0}$. A general rotation $U(\xi, \eta, \zeta) \in SU(2)$ can be implemented with the help of three wave-plates, see Eq.(51). A general boost can be implemented with dichroic elements realizing Eq.(82). The global factor there, $\exp(-\alpha_s/2)$, corresponds to an overall intensity attenuation. We can thus in principle realize any transformation of the form $\exp(-\vec{f} \cdot \vec{\rho})$ by using optical elements like wave-plates and dichroic elements. In particular, by letting a polarization state pass through two consecutive dichroic elements – each corresponding to a boost – we could make appear a phase between initial and final states. This is a geometric phase rooted on Thomas rotation, which can thus be exhibited by using the tools of polarization optics. Thus, we have here another example showing the topological root shared by two quite distinct physical phenomena.

7. Conclusion

Berry's phase was initially seen as a surprising result, which contradicted the common wisdom that only dynamical phases would show up when dealing with adiabatically evolving states. But soon after its discovery it brought to light a plethora of physical effects sharing a common topological or geometrical root. Once the initial concept was relatively well understood, people could recognize its manifestation in previously studied cases, like the Aharonov-Bohm effect and the Pancharatnam's prescription for establishing whether two

polarization states of light are in phase. Thanks to the contributions of a great number of researchers, Berry's phase has evolved into a rich subject of study that embraces manifold aspects. There are still several open questions and partially understood phenomena, as well as promising approaches to implement practical applications of geometrical phases, notably those related to quantum information processing. The present Chapter can give but a pale portrait and a limited view of what is a wide and rich subject. However, it is perhaps precisely out of these limitations that it could serve the purpose of awakening the reader's interest for studying in depth such a fascinating subject-matter.

8. References

- M. V. Berry, "Quantal phase factors accompanying adiabatic changes", *Proc. R. Soc. London Ser. A*, vol. 392, pp. 45-57, 1984.
- A. Tomita and R. Y. Chiao, "Observation of Berry's Topological Phase by Use of an Optical Fiber", *Phys. Rev. Lett.*, vol. 57 pp. 937-940, 1986.
- S. Pancharatnam, "Generalized theory of interference and its applications", *Proceedings of the Indian Academy of Science A*, vol. 44, pp. 247-262, 1956.
- Y. Aharonov et al., "Phase change during a cyclic quantum evolution", *Phys. Rev. Lett.*, vol. 58, pp. 1593-1596, 1987.
- J. Samuel and R. Bhandari, "General Setting for Berry's Phase", *Phys. Rev. Lett.*, vol. 60, pp. 2339-2342, 1988.
- H. M. Wong et al., "Quantum Geometric Phase between Orthogonal States", *Phys. Rev. Lett.*, vol. 94, pp. 070406-1-070406-4, 2005.
- A. Uhlmann, "Parallel transport and quantum holonomy along density operators", *Rep. Math. Phys.*, vol. 24, pp. 229-240, 1986.
- E. Sjöqvist et al., "Geometric Phases for Mixed States in Interferometry", *Phys. Rev. Lett.*, vol. 85, pp. 2845-2849, 2000.
- N. Mukunda and R. Simon, "Quantum Kinematic Approach to the Geometric Phase. I. General Formalism", *Ann. Phys. (N. Y.)*, vol. 228, pp. 205-268, 1993.
- A. Bohm et al., *The Geometric Phase in Quantum Systems*, Springer, New York, 2003.
- A. G. Wagh and V. C. Rakhecha, "Gauge-independent formalism for parallel transport, geodesics and geometric phase", *J. Phys. A: Math. Gen.*, vol. 32, 5167-5178, 1999.
- R. Simon and N. Mukunda, "Minimal three-component SU(2) gadget for polarization optics", *Phys. Lett. A*, vol. 143, pp. 165-169, 1990.
- J. C. Loredo et al., "Measurement of Pancharatnam's phase by robust interferometric and polarimetric methods", *Phys. Rev. A* vol. 80, pp. 012113-1-012113-9, 2009.
- J. C. Loredo et al., "Measurement of geometric phases by robust interferometric methods", *J. of Phys.: Conf. Ser.*, vol. 274, pp. 012140-1-012140-9, 2011.
- Y. Ota et al. "Geometric quantum gates in liquid-state NMR based on a cancellation of dynamical phases", *Phys. Rev. Lett.*, vol. 80, pp. 052311-1-052311-4, 2009.
- E. Sjöqvist, "A new phase in quantum computation", *Physics* 1, 35, 2008. Available: <http://link.aps.org/doi/10.1103/Physics.1.35>.
- S. Fillip et al. "Experimental Demonstration of the Stability of Berry's Phase for a Spin-1/2 Particle", *Phys. Rev. Lett.*, vol. 102, pp. 030404-1-030404-4, 2009.
- A. G. Wagh and V. C. Rakhecha, "On measuring the Pancharatnam phase. II. SU(2) polarimetry", *Phys. Lett. A*, vol. 197, pp. 112-115, 1995.

- A. G. Wagh and V. C. Rakhecha, "On measuring the Pancharatnam phase. I. Interferometry", *Phys. Lett. A*, vol. 197, pp. 107-111, 1995.
- A. G. Wagh et al., "Experimental Separation of Geometric and Dynamical Phases Using Neutron Interferometry", *Phys. Rev. Lett.*, vol. 78, pp. 755-759, 1997.
- A. G. Wagh et al., "Neutron polarimetric separation of geometric and dynamical phases", *Phys. Lett. A*, vol. 268, 209-216 (2000).
- R. Simon and N. Mukunda, "Universal SU(2) gadget for polarization optics", *Phys. Lett. A*, vol. 138, pp. 474-480, 1989.
- J. C. Loredo, "Geometric phase in photonics", Master Thesis, Physics Section, Pontificia Universidad Católica del Perú, Lima-Peru, 2011.
- H. Rauch et al., "Verification of coherent spinor rotation of fermions", *Phys. Lett. A*, vol. 54, 425-427, 1975.
- S. Haroche and J-M. Raimond, *Exploring the Quantum*, Oxford University Press, Oxford, 2007.
- M. Ericsson et al. "Measurement of Geometric Phases for Mixed States Using Single Photon Interferometry", *Phys. Rev. Lett.*, vol. 94, pp. 05041-1-04041-4, 2005.
- J. G. Peixoto de Faria et al. "Phases of quantum states in completely positive non-unitary evolution", *Europhys. Lett.*, vol. 62, pp. 782-788, 2002
- J. D. Jackson, *Classical Electrodynamics*, 2nd. Ed., John Wiley and Sons, New York, 1975.
- J. D. Bjorken and S. D. Drell, *Relativistic Quantum Mechanics*, McGraw-Hill, New York, 1964.
- H. Goldstein, *Classical Mechanics*, 2nd. Ed., Addison-Wesley, Reading, Massachusetts, 1980.

Bohmian Trajectories and the Path Integral Paradigm – Complexified Lagrangian Mechanics

Valery I. Sbitnev

*B. P. Konstantinov St.-Petersburg Nuclear Physics Institute,
Russ. Ac. Sci., Gatchina, Leningrad District
Russia*

1. Introduction

All material objects perceivable by our sensations move in real 3D-space. In order to describe such movement in strict mathematical forms we need to realize, first, what does the space represent as a mathematical abstraction and how motion in it can be expressed? Isaac Newton had gave many cogitations with regard to categories of the space and time. Results of these cogitations have been devoted to formulating categories of absolute and relative space and time (Stanford Encyclopaedia, 2004): (a) material body occupies some place in the space; (b) absolute, true, and mathematical space remains similar and immovable without relation to anything external; (c) relative spaces are measures of absolute space defined with reference to some system of bodies or another, and thus a relative space may, and likely will, be in motion; (d) absolute motion is the translation of a body from one absolute place to another; relative motion is the translation from one relative place to another.

Observe, that space coordinates of a body can be attributed to center of mass of the body, and its velocity is measured as a velocity of motion of this center. It means, that a classical body can be replaced ideally by a mathematical point situated in the center of mass of the body. Velocity of the point particle is determined from movement of the center of mass per unit of time. Both point particle coordinates and its velocity are measured exactly. Its behavior can be computed unambiguously from formulas of classical mechanics (Lanczos 1970).

Appearance of quantum mechanics in the early twentieth century brought into our comprehension of reality qualitative revisions (Bohm, 1951). One problem, for example, arises at attempt of simultaneous measurement of the particle coordinate and its velocity. There is no method that could propose such measurements. Quantum mechanics proclaims weighty, nay, unanswerable principle of uncertainty prohibiting such simultaneous measurements. Therefore we can measure these parameters only with some accuracy limited by the uncertainty principle. From here it follows, that formulas of classical mechanics meet with failure as soon as we reach small scales. On these scales the particles behave like waves. It is said, in that case, about the wave-particle duality (Nikolić, 2007).

It would be interesting to note here, that as far back as 5th century, B. C., ancient philosopher Democritus, (Stanford Encyclopaedia, 2010), held that everything is composed of "atoms", which are physically indivisible smallest entities. Between atoms lies empty space. In such a view it means that the atoms move in the empty space. And only collisions of the atoms can effect on their future motions. One more standpoint on Nature, other than atomistic, originates from ancient philosopher Aristotle (Stanford Encyclopaedia, 2008). Among his fifth elements (Fire, Earth, Air, Water, and Aether), composing the Nature, the last element, Aether, has a particular sense for explanation of wave processes. It provides a good basis for understanding and predicting the wave propagation through a medium.

By adopting wave processes underlying the Nature one can explain of interference phenomena of light. Huygens (Andresse, 2005) gave such an explanation. In contrast to Newtonian corpuscular explanation, Huygens proposed that every point to which a luminous wave reached becomes a source of a spherical wave, and the sum of these secondary waves determines the form of the wave at any subsequent time. His name was coined in the Huygens's wave principle, (Born & Wolf, 1999).

Such a competition of the two standpoints, corpuscular and wave, can provide more insight penetration into problems taking place in the quantum realm. Here we adopt these standpoints as a program for action (Sbitnev, 2009a). The article consists of five sections. Sec. 2 begins from a short review of the classical mechanics methods and ends by Dirac's proposition as the classical action can show itself in the quantum realm. Feynman's path integral is a summit of this understanding. The path integral technique is used in Sec. 3 for computing interference pattern from N -slit gratings. In Sec. 4 the path integral is analyzed in depth. The Schrödinger equation results from this consideration. And as a result we get the Bohmian decomposition of the Schrödinger equation to pair of coupled equations, modified the Hamilton-Jacobi equation and the continuity equation. Sec. 5 studies this coupled pair in depth. And concluding Sec. 6 gives remarks relating to sensing our 3D-space on the quantum level.

2. From classic realm to quantum

A path along which a classical particle moves, Fig. 1, obeys to variational principles of mechanics. A main principle is the principle of least action (Lanczos, 1970). The action S is a scalar function that is inner production of dynamical entities of the particle (its energy, momentum, etc.) to geometrical entities (time, length, etc.). For a particle's swarm moving through the space along some direction, the action is represented as a surface be pierced by their trajectories. Observe that adjoining surfaces are situated in parallel to each other and the trajectories pierce them perpendicularly.

The action S is the time integral of an energy function, that is the Lagrange function, along the path from A (starting from the moment t_0) to B (finishing at the moment t_1):

$$S = \int_{t_0}^{t_1} L(\vec{q}, \dot{\vec{q}}; t) dt . \quad (1)$$

Here $L(\vec{q}, \dot{\vec{q}}; t)$ is the Lagrange function representing difference of kinetic and potential energies of the particle. And \vec{q} and $\dot{\vec{q}}$ are its coordinate and velocity. Scientists proclaim that the action S remains constant along an optimal path of the moving particle. It is the principle

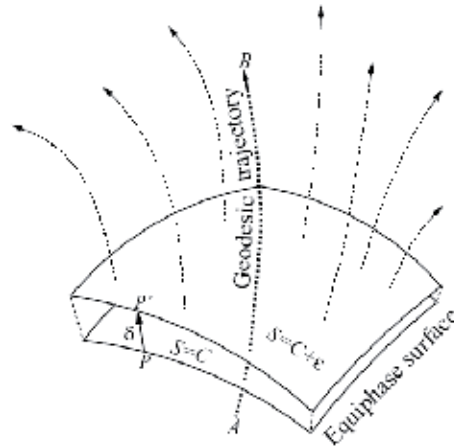

Fig. 1. Particle, at passing from A to B, moves along geodesic trajectory - the trajectory satisfying the principle of least action. All geodesic trajectories intersect equiphasic surfaces, $S=C$, $S = C+\epsilon$, perpendicularly (Lanczos, 1970).

of least action. According to this principle, finding of the optimal path adds up to solution of the extremum problem $\delta S = 0$. The solution leads to establishing the Lagrangian mechanics (Lanczos, 1970). We sum up the Lagrangian mechanics by presenting its main formulas via The Legendre's dual transformations as collected in Table 1:

Variables :	Variables :
Coordinate: $\vec{q} = (q_1, q_2, \dots, q_N)$	Coordinate: $\vec{q} = (q_1, q_2, \dots, q_N)$
Momentum: $\vec{p} = (p_1, p_2, \dots, p_N)$	Velocity: $\dot{\vec{q}} = (\dot{q}_1, \dot{q}_2, \dots, \dot{q}_N)$
Hamiltonian function:	Lagrangian function:
$H(\vec{q}, \vec{p}; t) = \sum_{n=1}^N p_n \dot{q}_n - L(\vec{q}, \dot{\vec{q}}; t)$ $\frac{\partial H}{\partial p_n} = \dot{q}_n$ $\frac{\partial H}{\partial q_n} = -\dot{p}_n$	$L(\vec{q}, \dot{\vec{q}}; t) = \sum_{n=1}^N p_n \dot{q}_n - H(\vec{q}, \vec{p}; t)$ $\frac{\partial L}{\partial \dot{q}_n} = p_n$ $\frac{\partial L}{\partial q_n} = \dot{p}_n$

Table 1. The Legendre's dual transformations

The Hamilton-Jacobi equation (HJ-equation)

$$-\frac{\partial S}{\partial t} = H(\vec{q}, \vec{p}; t), \quad (2)$$

describing behavior of the particle in $2N$ -dimensional phase space is one of main equations of the classical mechanics. Let us glance on Fig. 1. Gradient of the action S can be seen as normal to the equiphase surface $S = \text{const}$. Consider two nearby surfaces $S = C$ and $S = C + \varepsilon$. Let us trace normal from an arbitrary point P of the first surface up to its intersection with the second surface at point P' . Next, make another shift of the surface that is 2ε distant away from the first surface, thereupon on 3ε , and so forth. Until all space will be filled with such secants. Normals drawn from P to P' thereupon from P' to P'' , and so forth, disclose possible trajectory of the particle, since $\nabla S = \varepsilon / \delta$ represents a value of the gradient of S . When ε and δ tend to zero, this relation can be expressed in the vector form

$$\vec{p} = \nabla S. \quad (3)$$

So far as the momentum $\vec{p} = m\vec{v}$ (m is a particle mass) has a direction tangent to the trajectory, then the following statement is true (Lanczos, 1970): *trajectory of a moving particle is perpendicular to the surface $S = \text{const}$* . Dotted curves in Fig. 1 show bundle of trajectories intersecting the surfaces S perpendicularly.

The particle's swarm moving through space can be dense enough. It is appropriate to mention therefore the Liouville theorem, that adds to the conservation law of energy one more a conservation law. Meaning of the law is that a trajectory density is conserved independently of deformations of the surface that encloses these trajectories. Mathematically, this law is expressed in a form of the continuity equation

$$\frac{\partial \rho}{\partial t} + (\vec{v} \cdot \nabla \rho). \quad (4)$$

Here ρ is a density of moving mechanical points with the velocity $\vec{v} = \vec{p} / m$.

Thus we have two equations, the HJ-equation (2) and the continuity equation (4) that give mathematical description of moving classical particles undergoing no noise. Draw attention here, that the continuity equation depends on solutions of the HJ-equation via the term $\vec{v} = \nabla S / m$. On the other hand we see, that the HJ-equation does not depend on solutions of the continuity equation. This is essential moment at description of moving ensemble of the classical objects.

Starting from a particular role of the action, which it has in classical mechanics, Paul Dirac drew attention in 1933 (Dirac, 1933) that the action can play a crucial role in quantum mechanics also. The action can exhibit itself in expressions of type $\exp\{iS / \hbar\}$. It is appropriate to notice the following observation: the action here plays a role of a phase shift. According to the principle of least action, we can guess that the phase shift should be least along an optimal path of the particle. In 1945 Paul Dirac emphasize once again, that the classical and quantum mechanics have many general points of crossing (Dirac, 1945). In particular, he had written in this article: "We can use the formal probability to set up a quantum picture rather close to the classical picture in which the coordinates q of a dynamical system have definite values at any time. We take a number of times t_1, t_2, t_3, \dots following closely one after another and set up the formal probability for the q 's at each of these times lying within specified small ranges, this being permissible since the q 's at any time all commute. We then get a formal probability for the trajectory of the system in quantum mechanics lying within certain limits. This enables us to speak of some trajectories being improbable and others being likely".

Next, Richard Feynman undertook successful search of acceptable mathematical apparatus (Feynman, 1948) for description of evolution of quantum particles traveling through an experimental device. The term

$$\exp\{iS/\hbar\} = \exp\{iL\delta t/\hbar\} \quad (5)$$

plays a decisive role in this approach. Idea is that this term executes mapping of a wave function from one state to another spaced on a small time interval δt . And L is Lagrangian describing current state of the quantum object.

Feynman's insight has resulted in understanding that the integral kernel (so called propagator) of the time-evolution operator can be expressed as a sum over all possible paths (not just over the classical one) connecting the outgoing and ingoing points, q_a and q_b , with the weight factor $\exp\{iS(q_a, q_b; t)/\hbar\}$ (Grosche, 1993; MacKenzie, 2000) :

$$K(q_a, q_b) = \sum_{\text{all paths}} A \exp\{iS(q_a, q_b; T)/\hbar\}, \quad (6)$$

where A is an normalization constant.

Observe that The Einstein-Smoluchowski equation which describes the Brownian motion of classical particles within some volume (Kac, 1957), served him as an example. As follows from idea of the path integral (6), there are many possible trajectories, that can be traced from a source to a detector. But only one trajectory, submitting to the principle of least action, may be real. The others cancel each other because of interference effects. Such an interpretation is extremely productive at generating intuitive imagination for more perfect understanding quantum mechanics.

It is instructive further to consider some quantum tasks by using the Feynman path integral. Here we will compute interference patterns as a result of incidence of particles on N -slit gratings.

3. Interference pattern from an N -slit grating

Let a beam of coherent particles spreads through a grating. The grating shown in Fig. 2 has a set of narrow slits sliced in parallel. Width of the slits is sufficient in order that even large molecules could pass they through. Here we face with the uncertainty principle, $\Delta r \Delta p \geq \hbar/2$.

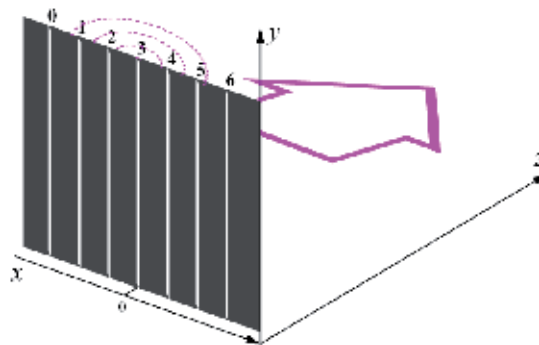

Fig. 2. Interference experiment in cylindrical geometry. Slit grating with $n=0, 1, \dots, N-1$ slits is situated in a plane (x, y) . Propagation of particles occurs along axis z .

It means, if diameter of the molecule is close to width of the slit then direction of its escape from the slit is uncertain. One can draw, as commonly, cylindrical waves that are divergent from each slit, as shown in this illustration on the slit 3. They illustrate equally probable outcomes from slits in different directions. In other words, a particle may fly out in any direction with equal probability.

3.1 Passing through a slit

Before we will analyze interference on the N -slit grating, let us consider a particle passing through a single slit. The problem has been considered in detail in (Feynman & Hibbs, 1965). We will study migration of the free particle in transversal direction, let it be axis x , at passing along z with a constant velocity, see Fig. 3. Lagrangian is as follows

$$L = m \frac{\dot{x}^2}{2} + \text{const} . \quad (7)$$

Here m is mass of the particle and \dot{x} is its transversal velocity. By translating a particle's position on a small value $\delta x = (x_b - x_a) \ll 1$, being performed for a small time $\delta t = (t_b - t_a) \ll 1$, we find that a weight factor, see (5), is as follows

$$e^{iL\delta t/\hbar} = \exp \left\{ \frac{im(x_b - x_a)^2}{2\hbar(t_b - t_a)} \right\} . \quad (8)$$

Pay attention on the following situation: so far as argument of the exponent contains multiplication of the Lagrangian L by δt , as shown in Eq. (5), we obtain result $(x_b - x_a)^2$ divided by $(t_b - t_a)$. Next we will see, that the weight factor (8) plays an important role. By means of such small increments let us trace passing the particle from a source through the slit, Fig. 3.

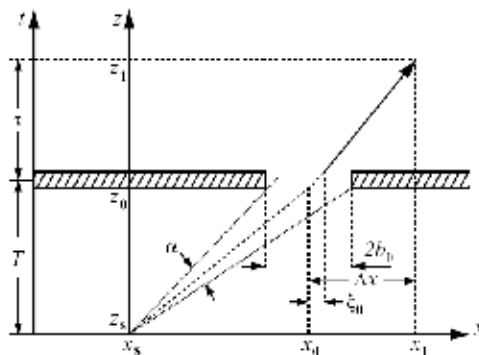

Fig. 3. A particle, being emitted from a source that is localized at a point (x_s, z_s) passes through a slit with width $2b_0$. It may undergo deflection from a straight direction at passing through the slit (Feynman & Hibbs, 1965).

We suppose, that at the time $t = 0$ the particle leaves a source localized at a point (x_s, z_s) . Let we know, that after a time T the particle enters to the vicinity $x_0 \pm b$ of a point x_0 , see Fig. 3. The question is: what is the probability to disclose the particle after a time τ at a point x_1 remote from the point x_0 at a distance $\Delta x = (x_1 - x_0)$? Let the particle outgoing from the point

x_s at the time $t=0$ passes a slit between the points $x_0 - b$ and x_0+b at the time $t=T$. Let us compute the probability of discovering the particle at some point x_1 after the time τ , i.e., at $t=T+\tau$. Because of existence of an opaque barrier a direct path to the point x_1 can be absent. In order to reach the point x_1 the particle should pass through the slit, maybe with some deflection from the direct path. In this connection, we partition the problem into two parts. Each part relates to movement of the free particle. In the first part we consider the particle which begins movement from the point x_s at the initial moment $t = 0$ and reaches to a point $x = x_0+\xi$, at the moment $t = T$, where $|\xi| \leq b$. In the second part we consider the same particle that after passing the point $x=x_0+\xi$ at the time $t=T$ moves to the point x_1 and reach it at the time $t=T+\tau$. A full probability amplitude is equal to integral convolution of two kernels, each describing movement of the free particle:

$$\psi(x_1, x_0, x_s) = \int_{-b}^b K(x_1, T + \tau; x_0 + \xi, T) K(x_0 + \xi, T; x_s, 0) d\xi. \quad (9)$$

Here the kernel reads

$$K(x_b, t_b; x_a, t_a) = \left[\frac{2\pi i \hbar (t_b - t_a)}{m} \right]^{-1/2} \exp \left\{ \frac{im(x_b - x_a)^2}{2\hbar(t_b - t_a)} \right\}. \quad (10)$$

It describes a transition amplitude from x_a to x_b for a time interval $(t_b - t_a)$ (Feynman & Hibbs, 1965). Consequently, the integral (9) computes the probability amplitude of transition from the source x_s to the point x_1 through the all possible intermediate points ξ situated within the interval $(x_0 - b, x_0 + b)$.

The expression (9) is written in accordance with a rule of summing amplitudes for successive events in time. The first event is the moving particle from the source to the slit. The second event is the movement of the particle from the slit to the point x_1 . The slit has a finite width. Passage through the slit is conditioned by different alternative possibilities. For that reason, we need to integrate along all over the slit width in order to get a right result. All particles, moving through the slit, are free particles and their corresponding kernels are given by the expression (10). By substituting this kernel to the integral (9) we get the following detailed form

$$\psi(x_1, x_0, x_s) = \int_{-b}^b \left(\frac{2\pi i \hbar \tau}{m} \right)^{-1/2} \exp \left\{ \frac{im(\Delta x - \xi)^2}{2\hbar \tau} \right\} \left(\frac{2\pi i \hbar T}{m} \right)^{-1/2} \exp \left\{ \frac{im(x_0 - x_s + \xi)^2}{2\hbar T} \right\} d\xi. \quad (11)$$

Integration here is fulfilled along the slit of a width $a=2b$, i.e., from $-b$ to $+b$.

Formally, range of the integration can be broadened from $-\infty$ to $+\infty$. But in this case, we need to introduce the step function $G(\xi)$ equal to unit in the interval $[-b, +b]$ and equal to zero outside this interval. In principle, we can approximate hard edged slits by series of the Gaussian functions, each with narrow halfwidth (Sbitnev, 2010). For sake of simplicity however, we confine ourselves by a single Gaussian form-factor

$$G(\xi) = \exp \left\{ -\xi^2 / 2b^2 \right\}. \quad (12)$$

It simulates slits with fuzzy edges. Effective width of this curve is conditioned by a parameter b . For such a form-factor roughly two thirds of all its area is situated between the

points $-b$ and $+b$. If the particles would move by classical way, then we can anticipate, that after the time τ a distribution of the particles will be similar to the distribution existing at T , see Fig. 4. New center x_1 of the distribution is shifted on a value Δx from the point x_0 . Width b_1 of the new distribution is also broadened. The both parameters, x_1 and b_1 , are determined from expressions

$$x_1 = x_0 \left(1 + \frac{\tau}{T} \right), \quad b_1 = b \left(1 + \frac{\tau}{T} \right). \tag{13}$$

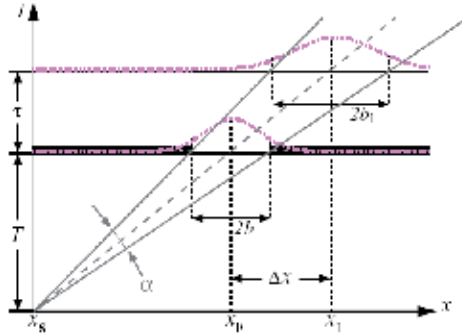

Fig. 4. Trajectories of particles passing through the Gaussian slit (Feynman & Hibbs, 1965), form a ray with an angle α of the divergent particle beam emanating from the source x_s .

Observe that quantum particles, in contrast to the classical ones, at scattering on the slit behave themselves like waves. The wavelike nature manifests itself via phase shifts of the moving particles in an observation point because of the de Broglie wavelength as innate character of quanta. According to the above stated remarks, Eq. (11) with inserted the form-factor of the slit, $G(\xi)$, now can be rewritten in the following form

$$\psi(x_1, x_0, x_s) = \int_{-\infty}^{\infty} \frac{mG(\xi)}{2\pi i \hbar \sqrt{T\tau}} \cdot \exp \left\{ \frac{im}{2\hbar} \left[\frac{(x_1 - x_0 - \xi)^2}{\tau} + \frac{(x_0 - x_s + \xi)^2}{T} \right] \right\} d\xi. \tag{14}$$

By substituting $G(\xi)$ from Eq. (12) to this expression and integrating it we obtain

$$\psi(x_1, x_0, x_s) = \sqrt{\frac{m}{2\pi i \hbar T}} \left(1 + \frac{\tau}{T} + i \frac{\hbar \tau}{mb^2} \right)^{-1/2} \exp \left\{ \frac{im}{2\hbar} \left(\frac{(x_1 - x_0)^2}{\tau} + \frac{(x_0 - x_s)^2}{T} - \frac{((x_1 - x_0)/\tau - (x_0 - x_s)/T)^2 \tau}{(1 + \tau/T + i \hbar \tau / mb^2)} \right) \right\}. \tag{15}$$

At integrating Eq. (14) we use a standard integral

$$\int_{-\infty}^{\infty} e^{\alpha \xi^2 + \beta \xi + \gamma} d\xi = \sqrt{\frac{\pi}{-\alpha}} e^{-\beta^2 / 4\alpha + \gamma}. \tag{16}$$

Before we will write out a final expression let us fulfill a series of replacements.

3.1.1 Series of replacements

First we define an effective slit's half-width $\sigma_0 = b/\sqrt{2}$. And further we define a complex time-dependent spreading

$$\sigma_\tau = \sigma_0 + i \frac{\hbar \tau}{2m\sigma_0(1 + \tau/T)}, \quad (17)$$

which has been defined in works (Sanz & Miret-Artés, 2007, 2008). More one step is to replace flight times T and τ by flight distances $(z_0 - z_s)$ and $(z_1 - z_0)$, namely, $T = (z_0 - z_s)/v_z$ and $\tau = (z_1 - z_0)/v_z$. Here v_z is a particle velocity along the axis z . We note that $mv_z = p_z$ is z -component of the particle momentum. This component is not changed at passing through the grating. Next, we introduce the de Broglie wavelength $\lambda_{dB} = h/p_z$, where $h=2\pi\hbar$ is the Planck constant. Rewrite in this view the complex time-dependent spreading (17) as the complex distance-dependent spreading

$$\sigma_{\tau \rightarrow z_1} = \sigma_0 + i \frac{\lambda_{dB}(z_1 - z_0)}{4\pi\sigma_0 \left(\frac{z_1 - z_s}{z_0 - z_s} \right)}. \quad (18)$$

Define now a dimensionless complex distance-dependent spreading as follows

$$\Sigma_{z_1} = \frac{z_1 - z_s}{z_0 - z_s} + i \frac{\lambda_{dB}(z_1 - z_0)}{4\pi\sigma_0^2} \quad (19)$$

and a dimensionless parameter characterizing remoteness of the source

$$\Xi_0 = 1 - \frac{(x_0 - x_s)(z_1 - z_0)}{(z_0 - z_s)(x_1 - x_0)}, \quad (20)$$

which tends to 1 as $z_s \rightarrow -\infty$.

Now we can use the above parameters, the dimensionless complex distance-dependent spreading Σ_{z_1} and the remoteness of the source Ξ_0 , in order to write out the wave function behind the slit. By rewriting Eq. (15) via these parameters we obtain

$$\psi(x, x_0, x_s, z) = \sqrt{\frac{m}{2\pi i \hbar T \Sigma_z}} \exp \left\{ i\pi \left[\frac{(x - x_0)^2}{\lambda_{dB}(z - z_0)} \left(1 - \frac{\Xi_0^2}{\Sigma_z} \right) + \frac{(x_0 - x_s)^2}{\lambda_{dB}(z_0 - z_s)} \right] \right\}. \quad (21)$$

Here we have removed the subscript 1 at the variables, x , z , and Σ_z , since they relate to every points of the space behind the slit. In particular, at removing the source to infinity, $z_s \rightarrow -\infty$, the parameter Ξ_0 tends to 1 and the wave function reduces down to the paraxial approximation

$$\psi(x, x_0, z) = A \exp \left\{ i\pi \frac{(x - x_0)^2}{\lambda_{dB}(z - z_0)} \left(1 - \frac{1}{\Sigma_z} \right) \right\}. \quad (22)$$

Here a normalization factor A reads

$$A = \sqrt{\frac{m}{2\pi i \hbar T \Sigma_z}}. \quad (23)$$

One can see it vanishes at $T \rightarrow \infty$. It means, as the source moves away to infinity its intensity tends to zero. In the paraxial approximation we need to ignore this expression and consider the parameter A simply as a factor that normalizes the wave function.

Further, for the sake of simplicity, we will deal with the paraxial approximation.

3.2 Matter waves behind the grating

Let us have a screen, on which an incident monochromatic beam of the particles is scattered. It has N slits ($n=0,1,2, \dots, N-1$) located at equal distance from each other, as shown in Fig. 2. Origin of coordinates is placed in the center of the slit grating. In this frame of reference, n -th slit has a position $x_0 = (n - (N-1)/2)d$, where d is a spacing between slits. The spacing is measured in units multiple to the wavelength λ_{dB} .

We need now to compute contributions of all paths that pass from the source through all slits in the screen and farther to a point of observation (x,z) . Per se, we should superpose in the observation point all wave functions (22) from all slits $n=0,1,2, \dots, N-1$. Such a superposition reads

$$|\Psi(x, z)\rangle = \frac{1}{N} \sum_{n=0}^{N-1} \psi \left(x, \left(n - \frac{N-1}{2} \right) d, z \right) \quad (24)$$

and probability density in the vicinity of the observation point (x,z) is

$$p(x, z) = \langle \Psi(x, z) | \Psi(x, z) \rangle. \quad (25)$$

3.2.1 Far-field diffraction

Before we will take up interference effects in the near-field region, let us consider an asymptotic limit of the formula (25) in the far-field region, Fig. 5. With this aim in mind, we replace the term $(n - (N-1)/2)d$ in Eq. (24) by kd , where k runs from $-(N-1)/2$ to $(N-1)/2$. Next, at summation we will neglect contribution of coefficients at $k^2 d^2$ emergent at decomposition $(x - kd)^2 = x^2 - 2xkd + k^2 d^2$. The point is that the terms with $k^2 d^2$ lead to phases muddled up on infinity. Because of it sum of all these exponents gives zero contribution. Other sums containing coefficients at x^2 and $2xkd$ can be easily computed. Next, at summation we use the mathematical equality

$$\sum_{k=-(N-1)/2}^{(N-1)/2} \exp\{ikx\} = \frac{\sin(Nx/2)}{\sin(x/2)}. \quad (26)$$

Intensity of the particle beam in the far-field region computed according to the above approximation is as follows

$$I(x, z) = I_0(x, z) \frac{\sin\left(\frac{N\zeta(x, z)}{2}\right)^2}{\sin\left(\frac{\zeta(x, z)}{2}\right)^2}. \quad (27)$$

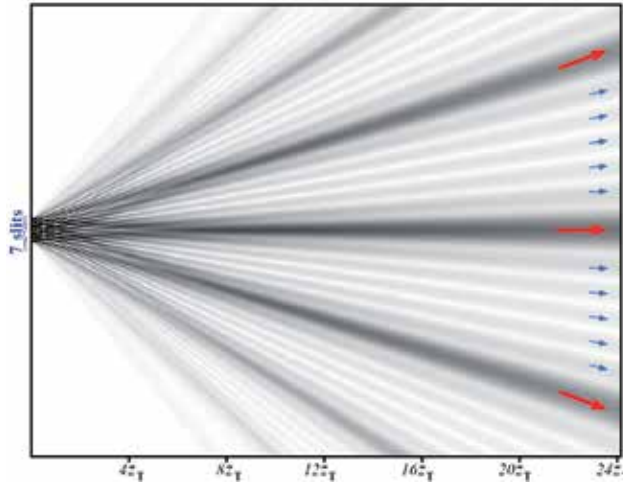

Fig. 5. Diffraction in the far-field zone at simulation of scattering thermal neutrons ($\lambda_{dB}=0.5$ nm) on $N=7$ slits grating. Width of slits $a=2\lambda_{dB}$, spacing $d=10\lambda_{dB}$, and the Talbot length $z_T=2d^2/\lambda_{dB}=200\lambda_{dB}$. Directions of principal and subsidiary maxima are pointed out by big red arrows and small blue arrows, respectively.

Here terms $\zeta(x,z)$ and $I_0(x,z)$ read

$$\left\{ \begin{array}{l} \zeta(x,z) = \frac{xd \frac{z\lambda_{dB}}{4\pi\sigma_z^2}}{2\sigma_z^2}, \\ I_0(x,z) = \frac{A^2}{N^2\sigma_z} \exp\left\{-\frac{x^2}{2\sigma_z^2}\right\}. \end{array} \right. \quad (28)$$

The parameter A is the normalization factor, see Eq. (23), and σ_z has the following form

$$\sigma_z = \sigma \sqrt{1 + \left(\frac{z\lambda_{dB}}{4\pi\sigma^2}\right)}. \quad (29)$$

This parameter is equivalent to the instantaneous Gaussian width presented in (Sanz and Miret-Artés, 2007).

Fig. 6 shows diffraction in the far-field zone from the grating having $N=7$ slits. Distance to the observation screen is $z=10^7 z_T=1$ m, where $z_T=2d^2/\lambda_{dB}=200\lambda_{dB}$ is the Talbot length. It will be explained below. It is seen, that the principal maxima are partitioned from each other by $N-2=5$ subsidiary maxima.

3.2.2 Near-field interference

Above we have considered a coherent flow of thermal neutrons, $\lambda_{dB}=0.5$ nm. Radius of these particles is 10^{-15} m. It is much smaller the de Broglie wavelength $\lambda_{dB} = 5 \cdot 10^{-10}$ m. For this reason, these particles can be considered as point particles, in contrast to enormous fullerene molecules shown in Fig 7.

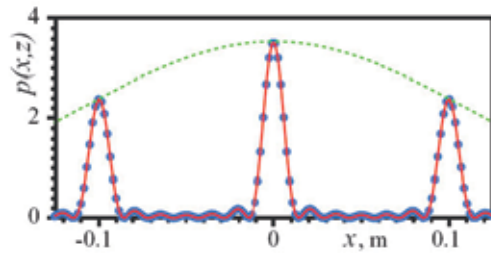

Fig. 6. Diffraction of thermal neutrons ($\lambda_{dB}=0.5$ nm) in the far-field zone from grating having $N=7$ slits. Distance to observation screen is $z=1$ m. Blue circles relate to the probability density calculated by Eqs. (24)–(25). Intensity (27) is drawn by red solid curve. Dotted green curve draws envelope $I_0(x,z) N^2$.

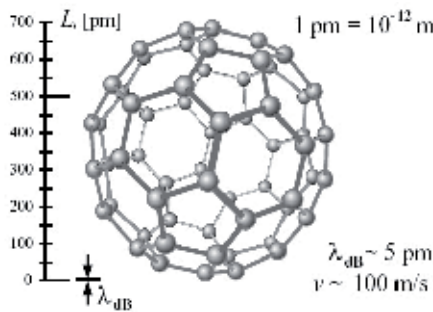

Fig. 7. The fullerene molecule C_{60} consists of 60 carbon atoms. Its radius is about 700 pm. At a flight velocity from a source $v=100$ m/s de Broglie wavelength of the fullerene molecule, λ_{dB} , is about 5 pm.

Here we consider interference phenomena in the near-field created by the fullerene molecules. Interest to such heavy molecules, having masses about 100 amu and more (Arndt et al., 2005; Brezger et al., 2002, 2005; Gerlich et al., 2011; Hackermüller et al., 2003, 2004; Nairz et al., 2003) is due to the fact that under ordinary circumstances they behave almost as classical objects. Indeed, diameter of the fullerene molecule C_{60} , see Fig. 7, is about 700 pm (Yanov & Leszczynski, 2004), but de Broglie wavelength is ~ 5 pm (Hackermüller et al., 2003; Juffmann et al., 2009). There is a problem to observe quantum interference for such large molecules having minuscule wavelengths.

At small distances from the grating we need in a acceptable scale in order to partition interference patterns on characteristic zones. Such a scale parameter is the Talbot length

$$z_T = 2 \frac{d^2}{\lambda_{dB}}. \quad (30)$$

This length starts from Henry Fox Talbot who discovered in 1836 a beautiful interference pattern (Talbot, 1836), that carries his name. Here d is the spacing between slits and λ_{dB} is the de Broglie wavelength of particles under consideration. Figs. 8 and 9 show emergence of such interference patterns in the near-field.

Fig. 8 shows the density distribution function (25) in a transient region from near-field to far-field (it is shown in gray color). The Talbot length ranges from 0 to $8z_T = 0.8$ m. The

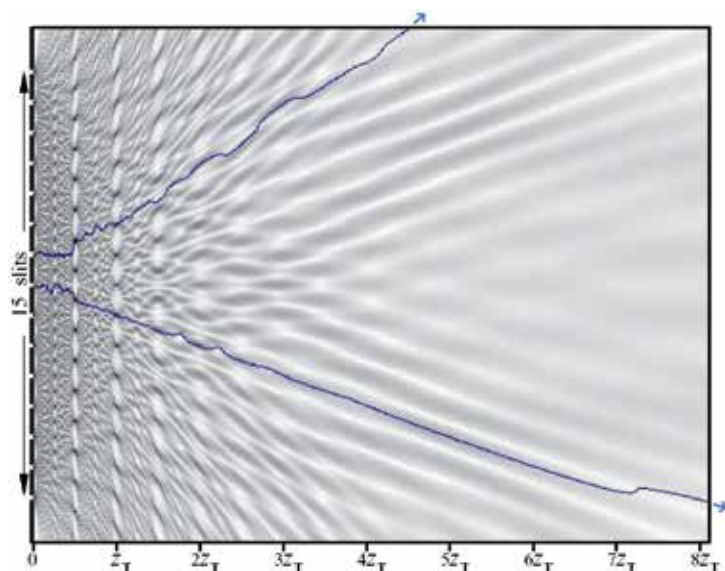

Fig. 8. Interference pattern of matter waves. The wave is presented by coherent fullerene molecule beam incident to a grating having $N = 15$ slits. De Broglie wavelength of the fullerene molecules is $\lambda_{dB} = 5$ pm. Spacing between slits $d = 500$ nm and slit width $a = 2b = 10$ nm. The Talbot length $z_T = 0.1$ m. Two Bohmian trajectories divergent from central area of the grating are shown in blue as examples.

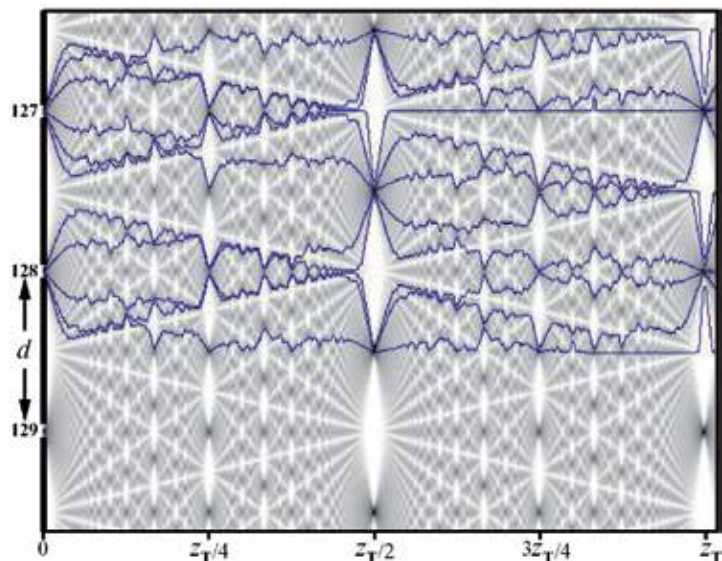

Fig. 9. Talbot carpet in the near-field of the grating having $N = 255$ slits. The pattern has been captured from central part of the grating. De Broglie wavelength of the fullerene molecules is $\lambda_{dB} = 5$ pm. Spacing between slits $d = 500$ nm and slit width $a = 2b = 10$ nm. The Talbot length $z_T = 0.1$ m. Some of the Bohmian trajectories passing by zigzag through spots with high density distribution are shown in blue as examples.

interference pattern emergent has been calculated for heavy particles, fullerene molecules, Fig. 7, incident on the grating containing $N = 15$ slits. Spacing between slits is $d = 500$ nm and slit width $a = 2b = 10$ nm. Mass of the fullerene molecules is about $m_{C60} \approx 1.2 \cdot 10^{-24}$ kg. And at average velocity about 100 m/s (Juffmann et al., 2009) the de Broglie wavelength is 5 pm. The Talbot length is about $z_T = 0.1$ m. One can easily evaluate that ratio of the Talbot length to the spacing between slits is equal to $2 \cdot 10^5$. So, a stripe between two slits extending from the grating up to the first Talbot length is extremely narrow. We can see that nearby the grating there exists a relatively perfect interference pattern. It decays with removing from the grating. And far from the grating characteristic rays divergent from it arise, as shown, for example, in Fig. 5

More fascinating picture arises at observation of the Talbot carpet as a peculiar manifestation of interference in near-field, see Fig. 9. The Talbot carpets arise if three conditions, Berry's conditions (Berry, 1996, 1997; Berry & Klein, 1996; Berry et al., 2001), are fulfilled: (a) paraxial beam; (b) arbitrary small ratio λ_{dB}/d ; (c) arbitrary large number of slits. In a strict sense, in the limits $N \rightarrow \infty$ and $\lambda_{dB}/d \rightarrow 0$ the Talbot carpet should transform to fractal interference pattern. It would look like δ -peaks everywhere densely populating the probability density distribution function $p(x,z)$, as shown, for example, in Fig. 10.

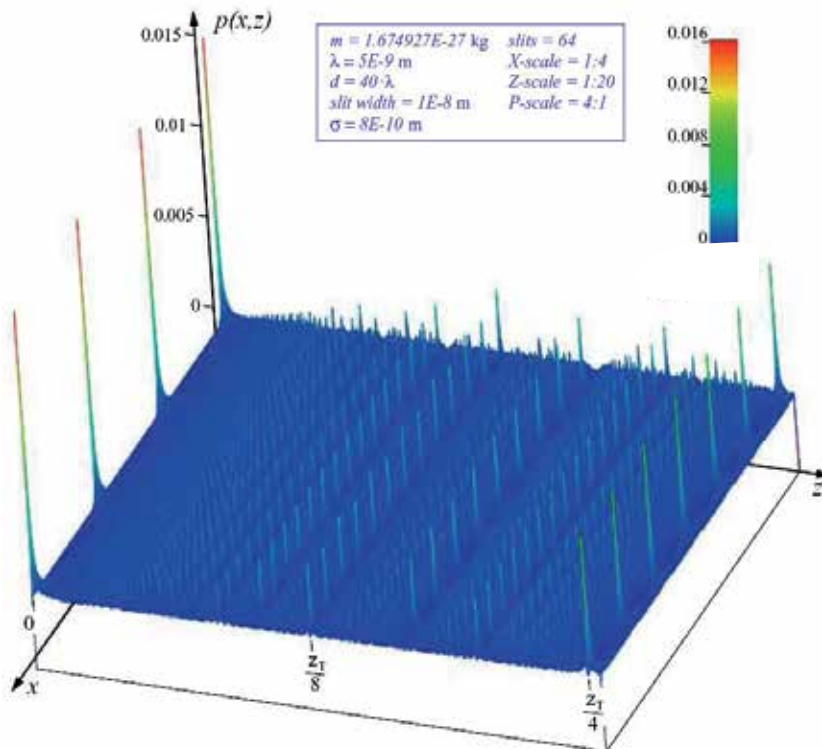

Fig. 10. Probability density distribution approaches infinite set of δ -functions as λ_{dB}/d tends to zero. Parameters here are as follows $N = 64$, $\lambda_{dB} = 0.5$ nm (thermal neutrons), $d = 20$ nm, $z_T = 6400$ nm (Sbitnev, 2009b).

In order to reach the Berry's conditions, we take number of slits as many as possible. The ratio λ_{dB}/d should be as small as possible, as well. Given $\lambda_{dB} = 5$ pm and $d = 500$ nm we have the ratio $\lambda_{dB}/d = 10^{-5}$. It is in good agreement with the condition (b). As for number of slits, as seen in Fig. 8 the interference patterns are washed away on first some Talbot lengths. It means, that number of the slits $N = 15$ is insufficient for observing of the Talbot carpet. Fig. 9 shows emergence of the Talbot carpet in the near-field in central part of the grating having 255 slits. As seen, $N = 255$ is sufficient number to get the Talbot carpet with perfect organization of alternation of high and low values of the density distribution.

3.3 Bohmian trajectories

How does particle pass through the slits? Answer to this problem is proposed in the Bohmian mechanics (Bohm, 1952a, 1952b; Bohm & Hiley, 1982; Hiley, 2002). In the next section we will consider this solution in detail. Here we show only some particular solutions. Two divergent Bohmian trajectories drawn in blue are shown in Fig. 8. They prefer to go along dark plots (high values of the density distribution) and avoid light-colored plots (low values of the density distribution). Fig. 9 also shows in blue a family of the Bohmian trajectories. In contrast to the trajectories shown in previous figure, here they demonstrate complex zigzag movements. The Bohmian trajectories result from solution of the guidance equation (Wyatt & Bittner, 2003; Nikolić, 2007; Sanz & Miret-Artés, 2007, 2008; Struyve & Valentini, 2009)

$$v_x = \dot{x} = \frac{\nabla S}{m} = \frac{\hbar}{m} \text{Im} \left(|\Psi\rangle^{-1} \nabla |\Psi\rangle \right). \quad (31)$$

According to the equation (31), position (x, z) of the particle in 2D space is given as follows

$$x(t) = x_0 + \int_0^t v_x d\tau, \quad z(t) = z_0 + v_z t. \quad (32)$$

Since we believe that longitudinal momentum, p_z , is constant in contrast to the transversal momentum p_x , the component z here is calculated by simple multiplication of v_z by t . In turn, velocity v_x , as seen from Eq. (31), is (a) proportional to gradient of the wave function; and (b) inversely proportional to the same wave function. It means: (a) a trajectory undergoes greatest variations in plots, where the wave function has slopes; and (b) the trajectory avoid areas, where the wave function tends to zero.

One could think that the Bohmian trajectories are physical artifacts, since they enter into a rough contradiction with the Heisenberg uncertainty principle, because of prediction in each time moment of exact values of coordinates and velocities of the particle (Bohm, 1952a, 1952b; Bohm & Hiley 1982). However, there is no here contradiction so far as the uncertainty principle refers to the measurement problem. Whereas the Bohmian trajectories are simply geodesic trajectories. At drawing the density distribution function we could use an orthogonal grid represented by geodesic trajectories and surfaces of equal phases, see, for example, Fig. 1. In the absence of intervention in a particle's history by measuring its parameters, real particle prefer to move along a geodesic trajectory. However, as soon as we undertake measurement of the particle's parameters we destroy its history. For example, if we measure position of the particle, we destroy its future history. If we measure its momentum, then we lose its past history.

The Bohmian trajectories in Fig. 9 are seen to fulfill intricate zigzag dances. One can see, the trajectories pass through areas where the density distribution has high values and avoid areas with low its values. The particles one can guess should perform zigzag motions. However, as was noted above, the ratio z_T to d is about $2 \cdot 10^{-5}$ and the observed pattern is within a very narrow strip. Consequently, these zigzags have very small curvatures. Vacuum fluctuations can provoke emergence of such deviations.

4. Variational computations

What could cause the particle to perform such a wavy and zigzag behaviors, as shown in the figures above? Possible answer could be as follows: a family of ordered slits in the screen poses itself as a quantum object that polarizes vacuum in the near-field region. The polarization, in turn, induces formation of a virtual particle's escort around of a flying real particle through the space. The escort corrects movement of the particle depending on the environment by interference of virtual particles with each other (Feynman & Hibbs, 1965).

4.1 Wave-particle duality, the Schrödinger equation

In contrast to classical mechanics where a single trajectory connecting the initial and final points submits to the principle of least action, in the quantum mechanics we need to consider all possible trajectories connecting these points in order to obtain clear answer. They pass through all intermediate points belonging to a transitional set \mathcal{R}^3 . All these paths should be evaluated jointly. Such a description goes back to the integral Chapman-Kolmogorov equation (Ventzel, 1975):

$$p(x, z; t + \tau) = \int_{\mathcal{R}^n} p(x, y; t) p(y, z, \tau) dy \quad (33)$$

which gives transitional probability densities of a Markovian sequence.

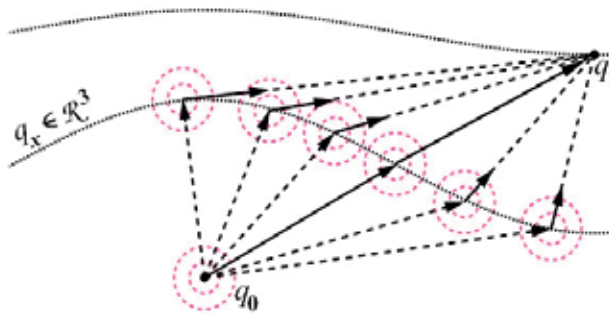

Fig. 11. Computation of all possible paths that pass from point q_0 to point q_1 through possible intermediate points $q_x \in \mathcal{R}^3$ represents a core of the path integral method. Pink circles conditionally represent radiation of Huygens waves.

Essential difference from the classical probability theory is that instead of the probabilities quantum mechanics deals with probability amplitudes containing imaginary terms. They bear information about phase shifts accumulated along paths. In that way, a transition from an initial state \vec{q}_0 to a final state \vec{q}_1 through all intermediate positions \vec{q}_x given on a conditional set \mathcal{R}^3 (see Fig. 11) is represented by the following path integral

$$\psi(\bar{q}_1, \bar{q}_0, t + \delta t) = \int_{\mathcal{R}^3} K(\bar{q}_1, \bar{q}_x; t + \delta t, t) \psi(\bar{q}_x, \bar{q}_0, t) \mathcal{D}^3 q_x \quad (34)$$

in the limit $\delta t \rightarrow 0$ and $\bar{q}_1 \rightarrow \bar{q}_x$. Here symbol $\mathcal{D}^3 q_x$ represents a differential element of volume in the set \mathcal{R}^3 .

Circular waves pictured by dotted circumferences in Fig. 11 illustrate working of the Huygens-Fresnel principle (Landsberg, 1957; Longhurst, 1970). The principle proclaims that each point \bar{q}_x at an advanced wave front is, in fact, the center of a fresh disturbance and it is the source of a new wave radiation. The advancing wave as a whole may be regarded as the sum of all the secondary waves arising from points in the medium already traversed by the wave. All the secondary waves are coherent, since they are activated from the one source given in \bar{q}_0 .

It is important to note, that all rays from such secondary sources represent virtual trajectories emanating from the source at \bar{q}_0 up to the point \bar{q}_1 . Along with the other virtual trajectories generated by the other secondary sources, all together they create in the point \bar{q}_1 an averaged effect of contribution of these secondary sources. This averaged effect shows whether a real particle passes by this route and what probability of this event can be.

We suppose that the integral kernel

$$K(\bar{q}_1, \bar{q}_x; t + \delta t, t) = \frac{1}{A} \exp \left\{ \frac{i}{\hbar} L(\bar{q}_x, \dot{\bar{q}}_x) \delta t \right\} \quad (35)$$

has a standard form of the Lagrangian (Feynman & Hibbs, 1965)

$$L(\bar{q}_x, \dot{\bar{q}}_x) = \frac{m}{2} \left(\frac{\bar{q}_1 - \bar{q}_x}{\delta t} \right)^2 - U(\bar{q}_x). \quad (36)$$

Here $U(\bar{q}_x)$ is a potential energy of the particle localized at the point $\bar{q}_x \in \mathcal{R}^3$. And $(\bar{q}_1 - \bar{q}_x) / \delta t$ is a velocity $\dot{\bar{q}}_x$ attached to the same point \bar{q}_x and oriented in the direction of the point \bar{q}_1 .

The next step is to expand terms, ingoing into the integral (34), into Taylor series. The wave function written at the left is expanded up to the first term

$$\psi(\bar{q}_1, \bar{q}_0, t + \delta t) \approx \psi(\bar{q}_1, \bar{q}_0, t) + \frac{\partial \psi}{\partial t} \delta t. \quad (37)$$

As for the terms under the integral, here we preliminarily make some transformations. We define a small increment

$$\bar{\xi} = \bar{q}_1 - \bar{q}_x \Rightarrow \mathcal{D}^3 q_x = -\mathcal{D}^3 \xi. \quad (38)$$

The Lagrangian (36) is written as

$$L(\bar{q}_x, \dot{\bar{q}}_x) = \frac{m}{2} \frac{\xi^2}{\delta t^2} - U(\bar{q}_1 - \bar{\xi}). \quad (39)$$

Here the potential energy $U(\bar{q}_1 - \bar{\xi})$ is subjected to expansion into the Taylor series by the small parameter $\bar{\xi}$. The under integral wave function $\psi(\bar{q}_x, \bar{q}_0, t) = \psi(\bar{q}_1 - \bar{\xi}, \bar{q}_0, t)$ is subjected to expansion into the Taylor series up to the second terms of the expansion

$$\psi(\bar{q}_1 - \bar{\xi}, \bar{q}_0, t) \approx \psi(\bar{q}_1, \bar{q}_0, t) - (\nabla \psi \cdot \bar{\xi}) + \nabla^2 \psi \cdot \xi^2 / 2. \quad (40)$$

Taking into account the expressions (37)-(40) and substituting theirs into Eq. (34) we get

$$\psi(\bar{q}_1, \bar{q}_0, t) + \frac{\partial \psi}{\partial t} \delta t = -\frac{1}{A} \int_{\mathcal{R}^3} \exp \left\{ \frac{i m \xi^2}{\hbar 2 \delta t} \right\} \left(1 - \frac{i}{\hbar} (U(\bar{q}_1) - (\nabla U \cdot \bar{\xi}) + \Delta U \cdot \xi^2 / 2) \delta t \right) \left(\psi(\bar{q}_1, \bar{q}_0, t) - (\nabla \psi \cdot \bar{\xi}) + \nabla^2 \psi \cdot \xi^2 / 2 \right) \mathcal{D}^3 \xi \quad (41)$$

One can see that the term $\psi(\bar{q}_1, \bar{q}_0, t)$ is presented from both the left side and from the right side. These both term can remove each other, if the right part will satisfy the following condition

$$-\frac{1}{A} \int_{\mathcal{R}^3} \exp \left\{ \frac{i m \xi^2}{\hbar 2 \delta t} \right\} \mathcal{D}^3 \xi = -\frac{1}{A} \left(\frac{2\pi i \hbar \delta t}{m} \right)^{3/2} = 1 \quad (42)$$

From here it follows

$$A = - \left(\frac{2\pi i \hbar \delta t}{m} \right)^{3/2}. \quad (43)$$

The power 3 arises here because that the integration is fulfilled on the 3-dimensional set \mathcal{R}^3 . It would be desirable also to integrate the terms $(\nabla \psi \cdot \bar{\xi})$ and $\nabla^2 \psi \cdot \xi^2 / 2$ existing in the integral (41). With this aim in the mind, we mention the following two integrals (Feynman & Hibbs, 1965)

$$\frac{1}{A} \int_{\mathcal{R}^3} \exp \left\{ \frac{i m \xi^2}{\hbar 2 \delta t} \right\} \bar{\xi} \mathcal{D}^3 \xi = 0 \quad (44)$$

and

$$\frac{1}{A} \int_{\mathcal{R}^3} \exp \left\{ \frac{i m \xi^2}{\hbar 2 \delta t} \right\} \xi^2 \mathcal{D}^3 \xi = \frac{i \hbar}{m} \delta t. \quad (45)$$

In accordance with the first integral, contributions of the terms $\nabla \psi$ and ∇U in the expression (41) disappear. Whereas, the terms with multiplier $\xi^2 / 2$ gains the factor $(i \hbar \delta t / m) / 2$.

Taking into account the above stated expressions, let us rewrite Eq.(41)

$$\frac{\partial \psi}{\partial t} \delta t = i \frac{\hbar \delta t}{2m} \Delta \psi - i \frac{\delta t}{\hbar} U(\bar{q}_1) \psi(\bar{q}_1, \bar{q}_0, t) + \frac{\delta t^2}{2m} \Delta U(\bar{q}_1) \psi(\bar{q}_1, \bar{q}_0, t). \quad (46)$$

The last term contains the factor δt^2 due to which contribution of this term to this equation is abolished in contrast with other terms as $\delta t \rightarrow 0$. By omitting this term, we come to the Schrödinger equation

$$i\hbar \frac{\partial \psi}{\partial t} = -\frac{\hbar^2}{2m} \Delta \psi + U(\vec{q}_1) \psi. \quad (47)$$

describing the function ψ , wave function, in the configuration space \mathcal{R}^3 . The subscript 1 here can be dropped.

4.2 The Bohmian decomposition

Let us examine the Schrödinger equation (47) by substituting the wave function ψ in the following form:

$$\psi(\vec{q}, \vec{p}, t) = \sqrt{\rho(\vec{q}, \vec{p}, t)} \exp\{iS(\vec{q}, \vec{p}, t) / \hbar\} = R(\vec{q}, \vec{p}, t) \exp\{iS(\vec{q}, \vec{p}, t) / \hbar\}. \quad (48)$$

Here functions $S(\vec{q}, \vec{p}, t)$ and $\rho(\vec{q}, \vec{p}, t)$ are real functions of their variables \vec{q} , \vec{p} , and t . The first function is the action which was mentioned earlier. And the second function is the probability density distribution defined as follows

$$\rho(\vec{q}, \vec{p}, t) = |\psi|^2 = \psi^* \psi. \quad (49)$$

Here we will consider the decomposition in a general view, i.e., the variables $\vec{q} = (q_1, q_2, \dots, q_N)$ and $\vec{p} = (p_1, p_2, \dots, p_N)$ are those representing the quantum system in $2N$ -dimensional phase space. It means, in particular, that there are several particles which can be considered in this space as one generalized particle.

By substituting the wave function $\psi(\vec{q}, \vec{p}, t)$ into the Schrödinger equation (47) we obtain

$$\begin{aligned} & \underbrace{-\frac{\partial S}{\partial t}}_{(a)} \cdot \psi + i\hbar \underbrace{\frac{1}{2\rho} \frac{\partial \rho}{\partial t}}_{(b)} \cdot \psi = \underbrace{\frac{1}{2m} (\nabla S)^2 \cdot \psi + U(\vec{q}) \cdot \psi}_{(a)} \\ & \underbrace{-\frac{i\hbar}{2m} \nabla^2 S \cdot \psi - \frac{i\hbar}{2m} \left(\frac{1}{\rho} \nabla \rho \right) (\nabla S) \cdot \psi}_{(b)} - \underbrace{\frac{\hbar^2}{2m} \left(\frac{1}{2\rho} \nabla^2 \rho \right) \cdot \psi + \frac{\hbar^2}{2m} \left(\frac{1}{2\rho} \nabla \rho \right)^2 \cdot \psi}_{(c)} \end{aligned} \quad (50)$$

Operators of gradient, ∇ , and laplacian, ∇^2 , read

$$\nabla = \left\{ \frac{\partial}{\partial q_1} i_1, \frac{\partial}{\partial q_2} i_2, \dots, \frac{\partial}{\partial q_N} i_N \right\}, \quad \nabla^2 = \left\{ \frac{\partial^2}{\partial q_1^2} + \frac{\partial^2}{\partial q_2^2} + \dots + \frac{\partial^2}{\partial q_N^2} \right\}. \quad (51)$$

A set $\{ i_1, i_2, \dots, i_N \}$ represents orthonormal basis of N -dimensional state space \mathcal{S}^N . The orthonormality means that $i_k \cdot i_j = \delta_{k,j}$ for all k, j ranging 1 to N .

Collecting together real terms (a) and (c), and separately imaginary terms (b) in Eq. (50) we obtain two coupled equations for real functions $S(\vec{q}, \vec{p}, t)$ and $\rho(\vec{q}, \vec{p}, t)$

$$-\frac{\partial S}{\partial t} = \frac{1}{2m} (\nabla S)^2 + U(\vec{q}) - \underbrace{\frac{\hbar^2}{2m} \left[\frac{\nabla^2 \rho}{2\rho} - \left(\frac{\nabla \rho}{2\rho} \right)^2 \right]}_{(c)}, \quad (52)$$

$$-\frac{\partial \rho}{\partial t} = \nabla \left(\rho \frac{\nabla S}{m} \right). \quad (53)$$

A term

$$Q = -\frac{\hbar^2}{2m} \left[\frac{\nabla^2 \rho}{2\rho} - \left(\frac{\nabla \rho}{2\rho} \right)^2 \right] = -\frac{\hbar^2}{2m} \frac{\nabla^2 R}{R} \quad (54)$$

enveloped by brace (c) in Eq. (52) is the quantum potential. It evaluates a measure of curvature of the N -dimensional state space induced by a prepared physical scene consisting of sources, detectors, and other experimental devices. Equations, (52) and (53), are seen to be the coupled pair of nonlinear partial differential equations. The first of the two equations, Eq. (52), is the Hamilton-Jacobi equation modified by the quantum potential $Q(\vec{q}, t)$. The second equation, Eq. (53), is the continuity equation. In the above equations we define the following computations

$$\vec{p} = m\vec{v} = \nabla S, \quad (55)$$

and

$$\frac{1}{2m}(\nabla S)^2 = \frac{1}{2m}p^2. \quad (56)$$

Here \vec{p} is momentum of the particle, \vec{v} is its velocity, and the last equation represents kinetic energy of the particle.

Equation (52) states that total particle energy is the sum of the kinetic energy, potential energy, and the quantum potential (Hiley, 2002). Equation (53), in turn, is interpreted as the continuity equation for probability density $\rho(\vec{q}, \vec{p}, t)$. It says that all individual trajectories demonstrate collective behavior like a liquid flux (Madelung, 1926; Wyatt, 2005), perhaps, superconductive one. We shall see further, that the quantum potential $Q(\vec{q}, \vec{p}, t)$ introduces corrections both in the kinetic energy and in the potential energy of the particle.

4.2.1 The quantum potential as an information channel

According to the observation

$$\rho^{-1} \nabla \rho = \nabla \ln(\rho) \quad (57)$$

we can rewrite the quantum potential by the following way

$$Q(\vec{q}, t) = \frac{\hbar^2}{2m} \left[\left(\frac{1}{2\rho} \nabla \rho \right)^2 - \frac{1}{2} \left(\frac{1}{\rho} \nabla \left(\rho \cdot \frac{1}{\rho} \nabla \rho \right) \right) \right] = -\frac{\hbar^2}{2m} \left(\frac{1}{2} \nabla \ln(\rho) \right)^2 - \frac{\hbar^2}{2m} \left(\frac{1}{2} \nabla^2 \ln(\rho) \right). \quad (58)$$

Define a logarithmic function

$$S_Q(\vec{q}, \vec{p}, t) = -\frac{1}{2} \ln(\rho(\vec{q}, \vec{p}, t)) \quad (59)$$

to be called further *quantum entropy*. It is like to the Boltzmann entropy. However if the Boltzmann entropy characterizes degree of order and chaos of classical gases, the quantum entropy evaluates analogous quality of the quantum liquid mentioned above. To be more defined, one can imagine the quantum liquid as ensemble of partially ordered virtual vortices (particle-antiparticle pairs) within vacuum. For example, such virtual vortices may be presented by spinning electron-positron pairs.

Substituting (59) into Eq. (58) we find that the quantum potential can be expressed in terms of this function

$$Q(\bar{q}, \bar{p}, t) = -\underbrace{\frac{\hbar^2}{2m}(\nabla S_Q)^2}_{(a)} + \underbrace{\frac{\hbar^2}{2m}\nabla^2 S_Q}_{(b)}. \quad (60)$$

It should be noted, that the term $-S_Q$ (negative S_Q) is named C-amplitude in (Bittner, 2003; Wyatt, 2005; Wyatt & Bittner, 2003). Here the term enveloped by brace (a) is viewed as the quantum corrector of the kinetic energy. And the term enveloped by brace (b) corrects the potential energy. Namely, substituting into Eq. (52) we obtain

$$-\frac{\partial S}{\partial t} = \frac{1}{2m}(\nabla S)^2 - \underbrace{\frac{\hbar^2}{2m}(\nabla S_Q)^2}_{(a)} + \underbrace{U(\bar{q}) + \frac{\hbar^2}{2m}\nabla^2 S_Q}_{(b)}. \quad (61)$$

In this equation the terms enveloped by brace (a) relate to the kinetic energy of the particle, and those enveloped by brace (b) relate to its potential energy.

Substituting also S_Q in the continuity equation (53) instead of ρ we obtain the entropy balance equation

$$\frac{\partial S_Q}{\partial t} = -(\bar{v} \cdot \nabla S_Q) + \frac{1}{2}(\nabla \bar{v}). \quad (62)$$

Here $\bar{v} = \nabla S / m$ is a particle speed. The rightmost term, $(\nabla \bar{v})$, describes a rate of the entropy flow produced by spatial divergence of the speed due to curvature of the N -dimensional state space. This term is nonzero in regions where the particle changes direction of movement.

5. Beyond the Bohm's insight into QM

Pair of the equations, the modified HJ equation (61) and the entropy balance equation (62), describes behavior of the quantum particle, subject to influence of the quantum entropy. Let us now multiply Eq. (62) by the factor $-i\hbar$ and add the result to Eq. (61). We obtain

$$-\frac{\partial \mathbf{S}}{\partial t} = \frac{1}{2m}(\nabla S)^2 + i\hbar \underbrace{\frac{1}{m}(\nabla S \cdot \nabla S_Q)}_{(a)} - \underbrace{\frac{\hbar^2}{2m}(\nabla S_Q)^2 + U(\bar{q}) - i\hbar \frac{1}{2}(\nabla \bar{v}) + \frac{\hbar^2}{2m}\nabla^2 S_Q}_{(b)}. \quad (63)$$

Here \mathbf{S} is sum of the action S and the quantum entropy S_Q (*complexified action*)

$$\mathbf{S} = S + i\hbar S_Q. \quad (64)$$

Terms enveloped by brace (a) can be rewritten as gradient of the squared complexified action

$$\frac{1}{2m}(\nabla\mathbf{S})^2 = \frac{1}{2m}(\nabla S)^2 + i\hbar\frac{1}{m}(\nabla S \cdot \nabla S_Q) - \frac{\hbar^2}{2m}(\nabla S_Q)^2. \quad (65)$$

As for the terms enveloped by brace (b) they could stem from expansion into the Taylor's series of the potential energy extended previously to a complex space, like a complex extension, for example, in (Poirier, 2008). In our case, the potential function is extended in the complex space, which has a small broadening into imaginary sector. Let us expand into the Taylor's series the potential function that has a complex argument

$$U(\bar{q} + i\varepsilon) \approx U(\bar{q}) + i(\bar{\varepsilon} \cdot \nabla U(\bar{q})) - \frac{\varepsilon^2}{2}\nabla^2 U(\bar{q}) + \dots \quad (66)$$

Now we will examine the last two terms. Here a small vector $\bar{\varepsilon}$ has dimensionality of length. But it should contain also the Planck constant, \hbar , in order to reproduce the second and third terms enveloped by brace (b) in Eq. (63). A minimal representation of this vector can be as follows

$$\bar{\varepsilon} = \frac{\hbar}{2m}s_B\bar{n}. \quad (67)$$

Here \bar{n} is unit vector pointing direction of the small increment, m is the particle mass, and s_B is universal constant, "reverse velocity",

$$s_B = 4\pi\varepsilon_0\frac{\hbar}{e^2} \approx 4.57 \times 10^{-7} \text{ [s/m]}. \quad (68)$$

Here $e \approx -1.6 \times 10^{-19}$ [C] is the elementary charge carried by a single electron and $\varepsilon_0 \approx 8.854 \times 10^{-12}$ [C²N⁻¹m⁻²] is the vacuum permittivity. The reverse velocity measures time required for traversing unit of a distance. Such a distance can be perimeter of orbit (Poluyan, 2005) at oscillating electron around. Observe that $r_B = s_B\hbar/m = 4\pi\varepsilon_0\hbar^2/me^2$ is value of the electron radius under its travelling on first orbit around the nucleus (Dirac, 1982). In our case it can be an effective radius of electron-positron pair under their virtual revolution about the mass center on the first orbit. From the above it follows, that $v_B = 1/s_B \approx 2.188 \times 10^6$ m/s is the Bohr velocity of electron oscillating on the first orbit about the mass center, and $r_B = \hbar/mv_B \approx 0.529 \times 10^{-10}$ m is the Bohr radius of this orbit. Here mv_B is the electron momentum.

In light of these remarks, we can rewrite the expansion (66) in the following form

$$\begin{aligned} U(\bar{q} + i\varepsilon) &\approx U(\bar{q}) + \underbrace{i\hbar\left(\bar{n} \cdot \left(\frac{s_B}{2m}\nabla U(\bar{q})\right)\right)}_{(b_1)} - \underbrace{\frac{\hbar^2}{2m}\left(\frac{s_B}{2m}\nabla^2 U(\bar{q})\right)}_{(b_2)} \\ &= U(\bar{q}) + \underbrace{\frac{i}{2}(\bar{n}r_B \cdot \nabla U(\bar{q}))}_{(b_1)} - \underbrace{\frac{1}{4}r_B^2\nabla^2 U(\bar{q})}_{(b_2)} \end{aligned} \quad (69)$$

A term enveloped by brace (b₁) contains unit vector \bar{n} that points out direction of the imaginary broadening. A force $\bar{F} = -\nabla U(\bar{q})$ multiplied by $\bar{n}r_B$ is elementary work performed at displacement on a length r_B along direction \bar{n} . The elementary work divided into \hbar is a rate of variation of the particle velocity per unit length, i.e., it represents divergence of the velocity, $\nabla \bar{v}$. So, the term enveloped by brace (b₁) can be rewritten in the following form

$$(b_1): \frac{1}{\hbar}(\bar{n}r_B \cdot \nabla U(\bar{q})) = -(\nabla \cdot \bar{v}). \quad (70)$$

As for the term $(s_B^2 / 2m) \cdot U(\bar{q}) = (1 / 2mv_B^2) \cdot U(\bar{q})$ which is placed over brace (b₂) in Eq. (69) it is dimensionless. Accurate to an additive dimensionless function $a\bar{q}^2 + (b\bar{q}) + c$ this term is comparable with S_Q , i.e., with $\ln(\rho)$. Taking into account that $s_B = 1/v_B$ we proclaim

$$(b_2): -\left(\frac{1}{2mv_B^2} \nabla^2 U(\bar{q})\right) = \frac{1}{2mv_B^2} (\nabla \bar{F}) = \nabla^2 S_Q. \quad (71)$$

Thus, a value of the Laplacian of $U(\bar{q})$ at the point \bar{q} can be interpreted as the density of sources (sinks) of the potential vector field $\bar{F} = -\nabla U(\bar{q})$ at this point. Accurate to the denominator $2mv_B^2$, it is proportional to the Laplacian of the quantum entropy S_Q .

We have defined the corrections (70) and (71) by extending coordinates of the real 3D space into imaginary domain on the value ε . It is equal to about the Bohr radius of the first orbit of the electron-positron virtual pair, $r_B \approx 5.292 \times 10^{-11}$ m. Energy of this pair is much smaller of the energy creating two real particles from the vacuum. Therefore such a shift, $\varepsilon = r_B/2$, can be considered as a virtual small shift to the imaginary domain.

Now we can define complexified momentum

$$\bar{\mathcal{P}} = m \dot{\bar{Q}} = \nabla S = \nabla S + i\hbar \nabla S_Q \quad (72)$$

and complexified coordinate

$$\bar{Q} = \bar{q} + i\varepsilon \quad (73)$$

as extended representations of the real vectors \bar{p} and \bar{q} . The complexified momentum \bar{P} differs from momentum \bar{p} by additional imaginary term $\hbar \nabla S_Q$. And the complexified coordinate \bar{Q} differs from real coordinate \bar{q} by the small imaginary vector (67). Now we can rewrite Eq. (63) as complexified the Hamilton-Jacobi equation:

$$-\frac{\partial S}{\partial t} = \frac{1}{2m} (\nabla S)^2 + U(\bar{q} + i\varepsilon) = \mathcal{H}(\bar{Q}, \bar{P}; t). \quad (74)$$

Here $H(\bar{Q}, \bar{P}; t)$ is a complexified Hamiltonian.

The total derivative of the complex action reads

$$\frac{dS}{dt} = \frac{\partial S}{\partial t} + \sum_{n=1}^N \frac{\partial S}{\partial Q_n} \frac{dQ_n}{dt} = \frac{\partial S}{\partial t} + \sum_{n=1}^N \mathcal{P}_n \dot{Q}_n \quad (75)$$

where complex derivative is (see Ch.2 in (Titchmarsh, 1976))

$$\frac{\partial \mathbf{S}}{\partial Q_n} = \frac{\partial S}{\partial q_n} + i\hbar \frac{\partial S_Q}{\partial q_n} = \mathcal{P}_n . \quad (76)$$

Combining Eq. (75) with (76) we come to the Legendre's dual transformation (Lanczos, 1970) that binds the Hamiltonian \mathcal{H} and the Lagrangian \mathcal{L} , and conversely:

$$\frac{d\mathbf{S}}{dt} = -\mathcal{H}(\bar{Q}, \bar{P}; t) + \sum_{n=1}^N \mathcal{P}_n \dot{Q}_n = \mathcal{L}(\bar{Q}, \dot{\bar{Q}}; t) . \quad (77)$$

We summarize this section by collecting formulas of the complexified Hamiltonian and Lagrangian mechanics via the Legendre's dual transformations in Table 2:

Variables :	Variables :
Coordinate: $\bar{Q} = \bar{q} + i\frac{\hbar}{2mv_B}\bar{n}$	Coordinate: $\bar{Q} = \bar{q} + i\bar{\varepsilon} = \bar{q} + i\frac{\hbar}{2mv_B}\bar{n}$
Momentum: $\bar{P} = \bar{p} + i\hbar\nabla S_Q$	Velocity: $\dot{\bar{Q}} = \dot{\bar{q}} + i\dot{\bar{\varepsilon}} = \dot{\bar{q}} + i\frac{\hbar}{2mv_B}\dot{\bar{n}}$
Hamiltonian function:	Lagrangian function:
$H(\bar{Q}, \bar{P}, t) = \sum_{n=1}^N \mathcal{P}_n \dot{Q}_n - L(\bar{Q}, \dot{\bar{Q}}, t)$	$L(\bar{Q}, \dot{\bar{Q}}, t) = \sum_{n=1}^N \mathcal{P}_n \dot{Q}_n - H(\bar{Q}, \bar{P}, t)$
$\frac{\partial H}{\partial P_n} = \dot{Q}_n$	$\frac{\partial L}{\partial \dot{Q}_n} = P_n$
$\frac{\partial H}{\partial Q_n} = -\dot{P}_n$	$\frac{\partial L}{\partial Q_n} = \dot{P}_n$

Table 2. The Legendre's dual transformations.

The Lagrangian equations of motions and the Legendre's transformations are invariant under the above fulfilled imaginary extension of the real momenta, p_n , and the real velocities, v_n , $n=1,2, \dots, N$. It should be noted, that the Hamiltonian function is quadratic in the momenta, \mathcal{P}_n , and the Lagrangian function is quadratic in the velocities, \dot{Q}_n . A conservation law in this case unifies conservation of energy represented by real part, $\text{Re}[\mathcal{H}(\bar{Q}, \bar{P}; t)]$, and the entropy balance (62) represented by imaginary part, $\text{Im}[\mathcal{H}(\bar{Q}, \bar{P}; t)]$. One can see from definition of the complexified velocity presented in this table, that tip of the small vector $\dot{\bar{\varepsilon}}$ performs rotating movements on the sphere of the Bohr radius $r_B = \hbar/2mv_B$. This radius is about 5.3×10^{-11} m for the electron-positron pair dancing on the first, virtual, orbit. Energy of this pair, $E = \hbar v_B/r_B e = 27$ V, lies much below energy of the

electron-positron creation, $E = \hbar c / \lambda_C e = \hbar(v_B a^{-1}) / (r_B a) e = 511 \text{ kV}$. Here e is the electric charge, c is the speed of light, λ_C is the Compton wavelength, and $\alpha \approx 1/137$ is the fine structure constant. From here it is seen, that there is a wide scope of energies for correcting movement of real particle by virtual ones.

6. Concluding remarks

Classical mechanics supposes a principle possibility of simultaneous measuring both coordinates (x, y, z) of material objects and their relative velocities (v_x, v_y, v_z) . In the beginning of 20th century scientists call in question such simultaneous measurements. Methods of the classical mechanics cease to give correct results on microscopic level. Instead of the classical equations describing behavior of a classical body, equations of quantum mechanics deal with wave functions that encompass behavior of any particle belonging to the same ensemble of coherent particles. The wave function bears information about distribution of particles that populate a space-time prepared by experimenter. It is said in that case, that it is a guidance function. It contains both the action S and a quantum entropy S_Q (logarithm of the density distribution with negative sign) in the following manner

$$|\Psi(\bar{Q}, \bar{P}, t)\rangle = \exp\{iS/\hbar - S_Q\}. \quad (78)$$

In contrast to the classical mechanics here the action traces all routes weighted with the factor proportional to the density distribution $\rho = \exp\{-S_Q\}$.

Wave functions within the same physical scene (the scene is represented by particle sources, detectors, and different physical devices placed between them) obey to superposition principle. Namely, sum of the wave functions is again a wave function that bears information about organization of the physical scene. At measurements we detect interference effects that are conditioned by a specific physical scene. There is no collapse of a wave function at the moment of detecting particle. Information relating to the physical scene exists until destruction of the scene happens. It can be picked up by a new particle again as soon as the particle will be generated by the source. The physical scene prepared by experimenter defines a space-time volume in which particles emitted by sources evolve. The Schrödinger equation (Schrödinger, 1926) gives formulas that determine a probable evolution of the particles within the space-time predefined by boundary conditions of a task. Madelung (Madelung, 1926) and then Bohm (Bohm, 1952a, 1952a) have demonstrated that behind this new equation of quantum mechanics (Schrödinger, 1926), classical equations, Hamilton-Jacobi equations together with the continuity equation, can be discerned. In contrast with the classical equations here a new term emerges - the quantum potential. According to the Madelung's views, the wave function simulates laminar flow of a "fluid" along geodesic paths, named further the Bohmian trajectories. Equiphase surfaces, in turn, are represented by secant surfaces of the trajectory's bundles. Because of these findings we cannot nowadays consider the space-time with the same point of view how it was formulated by thinkers of 17th century. The quantum potential compels to expand the 3D coordinate space onto the imaginary sector by unification the action S and the quantum entropy S_Q , that is, by introducing a complex action $S + i \hbar S_Q$. One way to envisage such a complex space is to imagine a hose-pipe. From a long distance it looks like a one dimensional line. But a closer inspection reveals that every point on the line is in fact a *circle*. It determines the unitary group $U(1)$, which generates the term $\exp\{iS/\hbar\}$ - a main term in the Feynman path integral.

7. Acknowledgement

Author thanks Miss Pipa (administrator of Quantum Portal) for preparing programs, that permitted to calculate and prepare Figs. 5, 8, and 9.

8. References

- Andresse, C. D. (2005). *Huygens The Man Behind the Principle*, Cambridge University Press, Cambridge
- Arndt, M., Hackermüller, L. & Reiger, E. (2005). Interferometry with large molecules: Exploration of coherence, decoherence and novel beam methods. *Brazilian Journal of Physics*, Vol. 35(No. 2A), 216–223
- Berry, M. (1996). Quantum fractals in boxes. *J. Phys. A: Math. Gen.*, Vol. 29, 6617–6629
- Berry, M. (1997). Quantum and optical arithmetic and fractals. In: *The Mathematical beauty of Physics*, J.-M. Drouffe & J.-B. Zuber, pp. 281–294, World Scientific, Singapore
- Berry, M. & Klein, S. (1996) Integer, fractional and fractal Talbot effects, *Journal of Modern Optics*, Vol. 43(No. 10), 2139–2164
- Berry, M., Marzoli, L. & Schleich, W. (2001). Quantum carpets, carpets of light. *Physics World*, (6), 39–44
- Bittner, E. R. (2003). Quantum initial value representations using approximate Bohmian trajectories. <http://arXiv.org/abs/quant-ph/0304012>
- Bohm, D. (1951). *Quantum theory*, Prentice Hall, N. Y.
- Bohm, D. (1952a). A suggested interpretation of the quantum theory in terms of "hidden variables", I. *Physical Review*, Vol. 85, 166–179
- Bohm, D. (1952b). A suggested interpretation of the quantum theory in terms of "hidden variables", II. *Physical Review*, Vol. 85, 180–193
- Bohm, D. J. & Hiley, B. J. (1982). The de Broglie pilot wave theory and the further development of new insights arising out of it. *Foundations of Physics*, Vol. 12(No. 10), 1001–1016
- Born, M. & Wolf, E. (1999). *Principles of Optics*, Cambridge University Press, Cambridge
- Brezger, B., Hackermüller, L., Uttenthaler, S., Petschinka, J., Arndt, M. & Zeilinger, A. (2002). Matter-wave interferometer for large molecules. *Phys. Rev. Lett.*, Vol. 88, 100404
- Brezger, B., Arndt, M. & Zeilinger, A. (2003). Concepts for near-field interferometers with large molecules. *J. Opt. B: Quantum Semiclass. Opt.*, Vol. 5(No. 2), S82–S89
- Dirac, P. A. M. (1933). The Lagrangian in quantum mechanics, *Physikalische Zeitschrift der Sowjetunion*, Vol. 3, 64–72
- Dirac, P. A. M. (1945). On the analogy between classical and quantum mechanics, *Phys. Rev. Lett.*, Vol. 17(Nos. 2 & 3), 195–199
- Dirac, P. A. M. (1982). *Principles of Quantum Mechanics*. Oxford University Press, Oxford, 4th edition
- Feynman, R. P. (1948). Space-time approach to non-relativistic quantum mechanics, *Rev. Mod. Phys.*, Vol. 20, 367–387
- Feynman, R. P. & Hibbs, A. (1965). *Quantum mechanics and path integrals*, McGraw Hill, N. Y.
- Gerlich, S., Eibenberger, S., Tomandl, M., Nimmrichter, S., Hornberger, K., Fagan, P. J., Tuxen, J., Mayor, M. & Arndt, M. (2011). Quantum interference of large organic molecules. *Nature Communications*, Vol. 2 (No. 263)

- Grosche, C. (1993). *An introduction into the Feynman path integral*. <http://arXiv.org/abs/hep-th/9302097>
- Hackermüller, L., Hornberger, K., Brezger, B., Zeilinger, A. & Arndt, M. (2003). Decoherence in a Talbot Lau interferometer: the influence of molecular scattering. *Appl. Phys. B*, Vol. 77, 781–787
- Hackermüller, L., Hornberger, K., Brezger, B., Zeilinger, A. & Arndt, M. (2004). Decoherence of matter waves by thermal emission of radiation. *Nature*, Vol. 427, 711–714
- Hiley, B. J. (2002). From the Heisenberg picture to Bohm: a new perspective on active information and its relation to Shannon information. In: *Quantum Theory: reconsideration of foundations, Proc. Int. Conf.*, A. Khrennikov, pp. 1–24, Växjö University Press, June 2001, Sweden
- Juffmann, T., Truppe, S., Geyer, P., Major, A. G., Deachapunya, S., Ulbricht, H. & Arndt, M. (2009). Wave and particle in molecular interference lithography. *Phys. Rev. Lett.*, Vol. 103, 263601.
- Kac, M. (1957). On some connections between probability theory and differential and integral equations, *Proc. Second Berkeley Symposium on Mathematical Statistics and Probability*, pp. 189–215, Berkeley, USA
- Lanczos, C. (1970). *The variational principles of mechanics*, Dover Publ., Inc., N. Y.
- Landsberg, G. S. (1957). *Optika*, Moscow-Leningrad, 4th edition
- Longhurst, R. S. (1970). *Geometrical and Physical Optics*. Longmans, London, 2nd edition
- MacKenzie, R. (2000). *Path integral methods and applications*, <http://arXiv.org/abs/quant-ph/0004090>
- Madelung, E. (1927). Quantumtheorie in hydrodynamische form. *Zts. f. Phys.*, Vol. 40, 322–326
- Nairz, O., Arndt, M. & Zeilinger, A. (2003). Quantum interference experiments with large molecules. *Am. J. Phys.*, Vol. 71(No. 4), 319–325
- Nikolić, H. (2007). Quantum mechanics: Myths and facts, *Found. Phys.*, Vol. 37(No. 11), 1563–1611
- Poirier, B. (2008). On flux continuity and probability conservation in complexified Bohmian mechanics. <http://arXiv.org/abs/0803.0193>
- Poluyan, P. V. (2005). Nonclassical ontology and nonclassical movement. *Kvantovaya Magiya*, Vol. 2(No. 3), 3119–3134.
- Sanz, A. S. & Miret-Artés, S. (2007). A causal look into the quantum Talbot effect, *J. Chem. Phys.*, Vol. 126, 234106
- Sanz, A. S. & Miret-Artés, S. (2008). A trajectory-based understanding of quantum interference, *J. Phys. A: Math. Gen.*, Vol. 41, 435303
- Sbitnev, V. I. (2009a). Bohmian trajectories and the Path Integral Paradigm. Complexified Lagrangian Mechanics. *Int. J. Bifurcation & Chaos*, Vol. 19(No. 9), 2335–2346
- Sbitnev, V. I. (2009b). N-slit interference: fractals in near-field region, Bohmian trajectories. <http://arxiv.org/abs/0907.4638>
- Sbitnev, V. I. (2010). Matter waves in the Talbot-Lau interferometry, <http://arxiv.org/abs/1005.0890>
- Schrödinger, E. (1926). An undulatory theory of the mechanics of atoms and molecules, *Phys. Rev.*, Vol. 28(No. 6), 1049–1070
- Stanford Encyclopaedia of Philosophy, (2004). Newton's Views on Space, Time, and Motion, <http://plato.stanford.edu/entries/newton-stm/>

- Stanford Encyclopaedia of Philosophy, (2008). Aristotle,
<http://plato.stanford.edu/entries/aristotle/>
- Stanford Encyclopaedia of Philosophy, (2010). Democritus,
<http://plato.stanford.edu/entries/democritus/>
- Struyve, W. & Valentini, A. (2009). De Broglie-Bohm guidance equations for arbitrary Hamiltonians. *J. Phys. A: Math. Theor.*, Vol. 42, 035301
- Talbot, H. F. (1836). Facts relating to optical science. *Philos. Mag.*, (No. 9), 401–407
- Titchmarsh, E. C. (1976). *The Theory of Functions*, Oxford Science Publ., Oxford
- Ventzel, A. D. (1975). *The course of stochastic processes theory*, Nauka, Moskow, in Russian
- Wyatt, R. E. (2005). *Quantum Dynamics with Trajectories: Introduction to Quantum Hydrodynamics*, Springer, N. Y.
- Wyatt, R. E. & Bittner, E. R. (2003). Quantum mechanics with trajectories: Quantum trajectories and adaptive grids.
<http://arXiv.org/abs/quant-ph/0302088>
- Yanov, I. & Leszczynski, J. (2004). Computer simulation of fullerenes and fullerites. In: *Computational materials science*, pp. 85–115. Elsevier B. V., Netherlands

A Fully Quantum Model of Big Bang

S. P. Maydanyuk¹, A. Del Popolo^{2,3}, V. S. Olkhovsky¹ and E. Recami^{4,5,6}

¹*Institute for Nuclear Research, National Academy of Sciences of Ukraine*

²*Istituto di Astronomia dell' Università di Catania, Catania*

³*Dipartimento di Matematica, Università Statale di Bergamo, Bergamo*

⁴*INFN-Sezione di Milano, Milan*

⁵*Facoltà di Ingegneria, Università statale di Bergamo, Bergamo*

⁶*DMO/FEEC, UNICAMP, Campinas, SP, Brazil*

¹*Ukraine*

^{2,3,4}*Italy*

1. Introduction

In order to understand what really happens in the formation of the Universe, many people came to the point of view that a quantum consideration of this process is necessary. After the publication of the first paper on the quantum description of Universe formation (DeWitt, 1967; Wheeler, 1968), a lot of other papers appeared in this topic (for example, see Refs. (Atkatz & Pagels, 1984; Hartle & Hawking, 1983; Linde, 1984; Rubakov, 1984; Vilenkin, 1982; 1984; 1986; Zel'dovich & Starobinsky, 1984) and some discussions in Refs. (Rubakov, 1999; Vilenkin, 1994) with references therein).

Today, among all variety of models one can select two approaches which are the prevailing ones: these are the Feynman formalism of path integrals in multidimensional spacetime, developed by the Cambridge group and other researchers, called the "*Hartle-Hawking method*" (for example, see Ref. (Hartle & Hawking, 1983)), and a method based on direct consideration of tunneling in 4-dimensional Euclidian spacetime, called the "*Vilenkin method*" (for example, see Refs. (Vilenkin, 1982; 1984; 1986; 1994)). Here, in the quantum approach we have the following picture of the Universe creation: a closed Universe with a small size is formed from "nothing" (vacuum), where by the word "nothing" one refers to a quantum state without classical space and time. A wave function is used for a probabilistic description of the creation of the Universe and such a process is connected with transition of a wave through an effective barrier. Determination of penetrability of this barrier is a key point in the estimation of duration of the formation of the Universe, and the dynamics of its expansion in the first stage. However, in the majority of these models, with the exception of some exactly solvable models, tunneling is mainly studied in details in the semiclassical approximation (see Refs. (Rubakov, 1999; Vilenkin, 1994)). An attractive side of such an approach is its simplicity in the construction of decreasing and increasing partial solutions for the wave function in the tunneling region, the outgoing wave function in the external region, and the possibility to define and to estimate in an enough simply way the penetrability of the barrier, which can be used to obtain the duration of the nucleation of the Universe. The *tunneling boundary condition*

(Vilenkin, 1994) could seem to be the most natural and clear description, where the wave function should represent an outgoing wave only in the enough large value of the scale factor a . However, is really such a wave free in the asymptotic region? In order to draw attention on the increase of the modulus of the potential with increasing value of the scale factor a and increasing magnitude of the gradient of such a potential, acting on this wave “through the barrier”, then one come to a serious contradiction: *the influence of the potential on this wave increases strongly with a !* Now a new question has appeared: what should the wave represent in general in the cosmological problem? This problem connects with another and more general one in quantum physics — the real importance to define a “free” wave inside strong fields. To this aim we need a mathematical stable tool to study it. It is unclear whether a connection between exact solutions for the wave function at turning point and “free” wave defined in the asymptotic region is correct.

Note that the semiclassical formula of the penetrability of the barrier is constructed on the basis of wave which is defined concerning zero potential at infinity, i.e. this wave should be free outgoing in the asymptotic region. But in the cosmological problem we have opposite case, when the force acting on the wave increases up to infinity in the asymptotic region. At the same time, deformations of the shape of the potential outside the barrier cannot change the penetrability calculated in the framework of the semiclassical approach (up to the second order). An answer to such problem can be found in non-locality of definition of the penetrability in quantum mechanics, which is reduced to minimum in the semiclassical approach (i. e. this is so called “error” of the cosmological semiclassical approach).

The problem of the correct definition of the wave in cosmology is reinforced else more, if one wants to calculate the incident and reflected waves in the internal region. *Even with the known exact solution for the wave function there is uncertainty in determination of these waves!* But, namely, the standard definition of the coefficients of penetrability and reflection is based on them. In particular, we have not found papers where the coefficient of reflection is defined and estimated in this problem (which differs essentially from unity at the energy of radiation close to the height of the barrier and, therefore, such a characteristics could be interesting from a physical point of view). Note that the semiclassical approximation put serious limits to the possibility of its definition at all (Landau & Lifshitz, 1989).

Thus, in order to estimate probability of the formation of the Universe as accurately as possible, we need a fully quantum definition of the wave. Note that the non-semiclassical penetrability of the barrier in the cosmological problems has not been studied in detail and, therefore, a development of fully quantum methods for its estimation is a perspective task.

Researches in this direction exist (Acacio de Barros et al., 2007), and in these papers was estimated the penetrability on the basis of tunneling of wave packet through the barrier. However, a stationary boundary condition has uncertainty that could lead to different results in calculations of the penetrability. The stationary approach could allow to clarify this issue. It is able to give stable solutions for the wave function (and results in Ref. (Maydanyuk, 2008) have confirmed this at zero energy of radiation), using the standard definition of the coefficients of the penetrability and reflection, is more accurate to their estimation.

Aims of this Chapter are: (1) to define the wave in the quantum cosmological problem; (2) to construct the fully quantum (non-semiclassical) methods of determination of the coefficients of penetrability of the barriers and reflection from them on the basis of such a definition of the wave; (3) to estimate how much the semiclassical approach differs in the estimation of the penetrability from the fully quantum one. In order to achieve this goal, we need to construct tools for calculation of partial solutions of the wave function. In order to resolve

the questions pointed out above, we shall restrict ourselves to a simple cosmological model, where the potential has a barrier and internal above-barrier region.

2. Cosmological model in the Friedmann–Robertson–Walker metric with radiation

2.1 Dynamics of Universe in the Friedmann–Robertson–Walker metric

Let us consider a simple model of the homogeneous and isotropic Universe in *Friedmann–Robertson–Walker (FRW) metric* (see Ref. (Weinberg, 1975), p. 438; also see Refs. (Brandenberger, 1999; Linde, 2005; Rubakov, 2005; Trodden & and Carroll, 2003)):

$$ds^2 = -dt^2 + a^2(t) \cdot \left(\frac{dr^2}{h(r)} + r^2(d\theta^2 + \sin^2 \theta d\phi^2) \right), \quad h(r) = 1 - kr^2, \quad (1)$$

where t and r, θ, ϕ are time and space spherical coordinates, the signature of the metric is $(-, +, +, +)$ as in Ref. (Trodden & and Carroll, 2003) (see p. 4), $a(t)$ is an unknown function of time and k is a constant, the value of which equals $+1, 0$ or -1 , with appropriate choice of units for r . Further, we shall use the following system of units: $\hbar = c = 1$. For $k = -1, 0$ the space is infinite (Universe of open type), and for $k = +1$ the space is finite (Universe of closed type). For $k = 1$ one can describe the space as a sphere with radius $a(t)$ embedded in a 4-dimensional Euclidian space. The function $a(t)$ is referred to as the “radius of the Universe” and is called the *cosmic scale factor*. This function contains information of the dynamics of the expansion of the Universe, and therefore its determination is an actual task.

One can find the function $a(t)$ using the Einstein equations taking into account the cosmological constant Λ in this metric (we use the signs according to the chosen signature, as in Ref. (Trodden & and Carroll, 2003) p. 8; the Greek symbols μ and ν denote any of the four coordinates t, r, θ and ϕ):

$$R_{\mu\nu} - \frac{1}{2} g_{\mu\nu} R = 8\pi G T_{\mu\nu} + \Lambda, \quad (2)$$

where $R_{\mu\nu}$ is the Ricci tensor, R is the scalar curvature, $T_{\mu\nu}$ is the energy-momentum tensor, and G is Newton’s constant. From (1) we find the Ricci tensor $R_{\mu\nu}$ and the scalar curvature R :

$$\begin{aligned} R_{tt} &= -3\frac{\ddot{a}}{a}, & R_{rr} &= \frac{a\ddot{a}}{h} + 2\frac{\dot{a}^2}{h} - \frac{h'}{hr} = \frac{2\dot{a}^2 + a\ddot{a} + 2k}{1 - kr^2}, \\ R_{\phi\phi} &= R_{\theta\theta} \sin^2 \theta, & R_{\theta\theta} &= a\ddot{a} r^2 + 2\dot{a}^2 r^2 - h - \frac{h'r}{2} + 1 = 2\dot{a}^2 r^2 + a\ddot{a} r^2 + 2kr^2 \end{aligned} \quad (3)$$

$$R = g^{tt}R_{tt} + g^{rr}R_{rr} + g^{\theta\theta}R_{\theta\theta} + g^{\phi\phi}R_{\phi\phi} = \frac{6\dot{a}^2 + 6a\ddot{a} + 6k}{a^2}. \quad (4)$$

The *energy-momentum tensor* has the form (see (Trodden & and Carroll, 2003), p. 8): $T_{\mu\nu} = (\rho + p) U_\mu U_\nu + p g_{\mu\nu}$, where ρ and p are energy density and pressure. Here, one needs to use the normalized vector of 4-velocity $U^t = 1, U^r = U^\theta = U^\phi = 0$. Substituting the previously calculated components (2) of the Ricci tensor $R_{\mu\nu}$, the scalar curvature (4), the components of the energy-momentum tensor $T_{\mu\nu}$ and including the component $\rho_{\text{rad}}(a)$, describing the radiation in the initial stage (equation of state for radiation: $p(a) = \rho_{\text{rad}}(a)/3$), into the Einstein’s equation (2) at $\mu = \nu = 0$), we obtain the *Friedmann equation* with the cosmological

constant (see p. 8 in Ref. (Trodden & and Carroll, 2003); p. 3 in Ref. (Brandenberger, 1999)):

$$\dot{a}^2 + k - \frac{8\pi G}{3} \left\{ \frac{\rho_{\text{rad}}}{a^2(t)} + \rho_{\Lambda} a^2(t) \right\} = 0, \quad \rho_{\Lambda} = \frac{\Lambda}{8\pi G}, \quad (5)$$

where \dot{a} is derivative a at time coordinate. From here, we write a general expression for the energy density:

$$\rho(a) = \rho_{\Lambda} + \frac{\rho_{\text{rad}}}{a^4(t)}. \quad (6)$$

2.2 Action, lagrangian and quantization

We define the action as

$$S = \int \sqrt{-g} \left(\frac{R}{16\pi G} - \rho \right) dx^4. \quad (7)$$

Substituting the scalar curvature (4), then integrating item at \ddot{a} by parts with respect to variable t , we obtain the *lagrangian*:

$$\mathcal{L}(a, \dot{a}) = \frac{3a}{8\pi G} \left(-\dot{a}^2 + k - \frac{8\pi G}{3} a^2 \rho(a) \right). \quad (8)$$

Considering the variables a and \dot{a} as generalized coordinate and velocity respectively, we find a generalized momentum conjugate to a :

$$p_a = \frac{\partial \mathcal{L}(a, \dot{a})}{\partial \dot{a}} = -\frac{3}{4\pi G} a \dot{a} \quad (9)$$

and then hamiltonian:

$$h(a, p_a) = p \dot{a} - \mathcal{L}(a, \dot{a}) = -\frac{1}{a} \left\{ \frac{2\pi G}{3} p_a^2 + a^2 \frac{3k}{8\pi G} - a^4 \rho(a) \right\}. \quad (10)$$

The passage to the quantum description of the evolution of the Universe is obtained by the standard procedure of canonical quantization in the Dirac formalism for systems with constraints. In result, we obtain the *Wheeler–De Witt (WDW) equation* (see (DeWitt, 1967; Levkov et al., 2002; Wheeler, 1968)), which can be written as

$$\begin{aligned} \left\{ -\frac{\partial^2}{\partial a^2} + V(a) \right\} \varphi(a) &= E_{\text{rad}} \varphi(a), \\ V(a) &= \left(\frac{3}{4\pi G} \right)^2 k a^2 - \frac{3\rho_{\Lambda}}{2\pi G} a^4, \\ E_{\text{rad}} &= \frac{3\rho_{\text{rad}}}{2\pi G}, \end{aligned} \quad (11)$$

where $\varphi(a)$ is wave function of Universe. This equation looks similar to the one-dimensional stationary Schrödinger equation on a semiaxis (of the variable a) at energy E_{rad} with potential $V(a)$. It is convenient to use system of units where $8\pi G \equiv M_{\text{p}}^{-2} = 1$, and to rewrite $V(a)$ in a generalized form as

$$V(a) = A a^2 - B a^4. \quad (12)$$

In particular, for the Universe of the closed type ($k = 1$) we obtain $A = 36$, $B = 12 \Lambda$ (this potential coincides with Ref. (Acacio de Barros et al., 2007)).

2.3 Potential close to the turning points: non-zero energy case

In order to find the wave function we need to know the shape of the potential close to the turning points. Let us find the *turning points* $a_{\text{tp},\text{in}}$ and $a_{\text{tp},\text{out}}$ concerning the potential (12) at energy E_{rad} :

$$a_{\text{tp},\text{in}} = \sqrt{\frac{A}{2B}} \cdot \sqrt{1 - \sqrt{1 - \frac{4BE_{\text{rad}}}{A^2}}}, \quad a_{\text{tp},\text{out}} = \sqrt{\frac{A}{2B}} \cdot \sqrt{1 + \sqrt{1 - \frac{4BE_{\text{rad}}}{A^2}}}. \quad (13)$$

Let us expand the potential $V(a)$ (13) in powers of $q_{\text{out}} = a - a_{\text{tp}}$ (where the point $a_{\text{tp},\text{in}}$ or $a_{\text{tp},\text{out}}$ is used as a_{tp} . Expansion is calculated at these points), where (for small q) we restrict ourselves to the liner term:

$$V(q) = V_0 + V_1 q, \quad (14)$$

where the coefficients V_0 and V_1 are:

$$\begin{aligned} V_0 &= V(a = a_{\text{tp},\text{in}}) = V(a = a_{\text{tp},\text{out}}) = A a_{\text{tp}}^2 - B a_{\text{tp}}^4 = E_{\text{rad}}, \\ V_1^{(\text{out})} &= -2A \cdot \sqrt{\frac{A}{2B} \left(1 - \frac{4BE_{\text{rad}}}{A^2}\right) \left(1 + \sqrt{1 - \frac{4BE_{\text{rad}}}{A^2}}\right)}, \\ V_1^{(\text{int})} &= 2A \cdot \sqrt{\frac{A}{2B} \left(1 - \frac{4BE_{\text{rad}}}{A^2}\right) \left(1 - \sqrt{1 - \frac{4BE_{\text{rad}}}{A^2}}\right)}. \end{aligned} \quad (15)$$

Now eq. (15) transforms into a new form at variable q with potential $V(q)$:

$$-\frac{d^2}{dq^2} \varphi(q) + V_1 q \varphi(q) = 0. \quad (16)$$

3. Tunneling boundary condition in cosmology

3.1 A problem of definition of “free” wave in cosmology and correction of the boundary condition

Which boundary condition should be used to obtain a wave function that describes how the wave function leaves the barrier accurately? A little variation of the boundary condition leads to change of the fluxes concerning the barrier and, as result, it changes the coefficients of penetrability and reflection. So, a proper choice of the boundary condition is extremely important. However before, let us analyze how much the choice of the boundary condition is natural in the asymptotic region.

- In description of collisions and decay in nuclear and atomic physics potentials of interactions tend to zero asymptotically. So, in these calculations, the boundary conditions are imposed on the wave function at infinity. In cosmology we deal with another, different type of potential: its modulus increases with increasing of the scale factor a . The gradient of the potential also increases. Therefore, *here there is nothing common to the free propagation*

of the wave in the asymptotic region. Thus, a direct passage of the application of the boundary condition in the asymptotic region into cosmological problems looks questionable.

- The results in Ref. (Maydanyuk, 2008), which show that when the scale factor a increases the region containing solutions for the wave function enlarges (and its two partial solutions), reinforce the seriousness of this problem. According to Ref. (Maydanyuk, 2008), the scale factor a in the external region is larger, the period of oscillations of each partial solution for the wave function is smaller. One has to decrease the time-step and as a consequence increase the calculation time. This increases errors in computer calculations of the wave function close the barrier (if it is previously fixed by the boundary condition in the asymptotic region). From here a natural conclusion follows on the impossibility to use practically the boundary condition at infinity for calculation of the wave (in supposition if we know it maximally accurately in the asymptotic region), if we like to pass from the semiclassical approach to the fully quantum one. Another case exists in problems of decay in nuclear and atomic physics where calculations of the wave in the asymptotic region are the most stable and accurate.
- One can add a fact that it has not been known yet whether the Universe expands at extremely large value of the scale factor a . Just the contrary, it would like to clarify this from a solution of the problem, however imposing a condition that the Universe expands in the initial stage.

So, we shall introduce the following **definition of the boundary condition** (Maydanyuk, 2010):

The boundary condition should be imposed on the wave function at such value of the scale factor a , where the potential minimally acts on the wave, determined by this wave function.

The propagation of the wave defined in such a way is close to free one for the potential and used value of the scale factor a (we call such a wave conditionally “free”). However, when we want to give a mathematical formulation of this definition we have to answer two questions:

1. What should the free wave represent in a field of a cosmological potential of arbitrary shape? How could it be defined in a correct way close to an arbitrary selected point?
2. Where should the boundary condition be imposed?

To start with, let us consider the second question namely where we must impose the boundary condition on the wave function. One can suppose that this coordinate could be (1) a turning point (where the potential coincides with energy of radiation), or (2) a point where the gradient from the potential becomes zero, or (3) a point where the potential becomes zero. But the clear condition of free propagation of the wave is the minimal influence of the potential on this wave. So, we define these coordinate and force so (Maydanyuk, 2010):

The point in which we impose the boundary condition is the coordinate where the force acting on the wave is minimal. The force is defined as minus the gradient of the potential.

It turns out that according to such a (local) definition the force is minimal at the external turning point $a_{tp, out}$. Also, the force, acting on the wave incident on the barrier in the internal region and on the wave reflected from it, has a minimum at the internal turning point $a_{tp, in}$. Thus, we have just obtain the internal and external turning points where we should impose the boundary conditions in order to determine the waves.

3.2 Boundary condition at $a = 0$: stationary approach versus non-stationary one

A choice of the proper boundary condition imposed on the wave function is directly connected with the question: could the wave function be defined at $a = 0$, and which value should it be equal to at this point in such a case? The wave function is constructed on the basis of its two partial solutions which should be linearly independent. In particular, these two partial solutions can be real (not complex), without any decrease of accuracy in determination of the total wave function. *For any desirable boundary condition imposed on the total wave function, such methods should work.* In order to achieve the maximal linear independence between two partial solutions, we choose one solution to be increasing in the region of tunneling and another one to be decreasing in this tunneling region. For the increasing partial solution we use as starting point a_x the internal turning point $a_{tp, in}$ at $E_{rad} \neq 0$ or zero point $a_x = 0$ at $E_{rad} = 0$. For the second decreasing partial solution the starting point a_x is chosen as the external turning point $a_{tp, out}$. Such a choice of starting points turns out to give us higher accuracy in calculations of the total wave function than starting calculations of both partial solutions from zero or from only one turning point.

In order to obtain the total wave function, we need to connect two partial solutions using one boundary condition, which should be obtained from physical motivations. According to analysis in Introduction and previous section, it is natural not to define the wave function at zero (or at infinity), but to find outgoing wave at finite value of a in the external region, where this wave corresponds to observed Universe at present time. But, in practical calculations, we shall define such a wave at point where forces minimally act on it. This is an initial condition imposed on the outgoing wave in the external region¹.

Let us analyze a question: which value has the wave function at $a = 0$? In the paper the following ideas are used:

- *the wave function should be continuous in the whole spatial region of its definition,*
- *we have outgoing non-zero flux in the asymptotic region defined on the basis of the total wave function,*
- *we consider the case when this flux is constant.*

The non-zero outgoing flux defined at arbitrary point requires the wave function to be complex and non-zero. The condition of continuity of this flux in the whole region of definition of the wave function requires this wave function to be complex and non-zero in the entire region. If we include point $a = 0$ into the studied region, then we should obtain the non-zero and complex wave function also at such point. If we use the above ideas, then we cannot obtain zero wave function at $a = 0$. One can use notions of nuclear physics, field in which the study of such questions and their possible solutions have longer history than in quantum cosmology. As example, one can consider elastic scattering of particles on nucleus (where we have zero radial wave function at $r = 0$, and we have no divergences), and alpha decay of nucleus (where we cannot obtain zero wave function at $r = 0$). *A possible divergence of the radial wave function at zero in quantum decay problem could be explained by existence of source at a point which creates the outgoing flux in the asymptotic region (and is the source of this flux).* Now the picture becomes clearer: any quantum decay could be connected with source at zero. This is why the vanishing of the total wave function at $a = 0$, after introduction of the wall at this point (like in Ref. (Acacio de Barros et al., 2007)), is not obvious and is only one of the possibilities.

If we wanted to study physics at zero $a = 0$, we should come to two cases:

¹ For example, on the basis of such a boundary condition for α -decay problem we obtain the asymptotic region where the wave function is spherical outgoing wave.

- If we include the zero point into the region of consideration, we shall use to quantum mechanics with included sources. In such a case, the condition of constant flux is broken. But a more general integral formula of non-stationary dependence of the fluxes on probability can include possible sources and put them into frameworks of the standard quantum mechanics also (see eq. (19.5) in Ref. (Landau & Lifshitz, 1989), p. 80). Perhaps, black hole could be another example of quantum mechanics with sources and sinks.
- We can consider only quantum mechanics with constant fluxes and without sources. Then we should eliminate the zero point $a = 0$ from the region of our consideration. In this way, the formalism proposed in this paper works and is able to calculate the penetrability and reflection coefficients without any lost of accuracy.

This could be a stationary picture of interdependence between the wave function at zero and the outgoing flux in the asymptotic region. In order to study the non-stationary case, then we need initial conditions which should define also the evolution of the Universe. In such a case, after defining the initial state (through set of parameters) it is possible to connect zero value of wave packet at $a = 0$ (i. e. without singularity at such a point) with non-zero outgoing flux in the asymptotic region. In such direction different proposals have been made in frameworks of semiclassical models in order to describe inflation, to introduce time or to analyze dynamics of studied quantum system (for example, see (Finelli et al., 1998; Tronconi et al., 2003)).

4. Direct fully quantum method

4.1 Wave function of Universe: calculations and analysis

The wave function is known to oscillate above the barrier and increase (or decrease) under the barrier without any oscillations. So, in order to provide an effective linear independence between two partial solutions for the wave function, we look for a first partial solution increasing in the region of tunneling and a second one decreasing in this tunneling region. To start with, we define each partial solution and its derivative at a selected starting point, and then we calculate them in the region close enough to this point using the *method of beginning of the solution* presented in Subsection 4.4.1. Here, for the partial solution which increases in the barrier region, as starting point we use the internal turning point $a_{tp,in}$ at non-zero energy E_{rad} or equals to zero $a = 0$ at null energy E_{rad} , and for the second partial solution, which decreases in the barrier region, we choose the starting point to be equal to the external turning point $a_{tp,out}$. Then we calculate both partial solutions and their derivatives in the whole required range of a using the *method of continuation of the solution* presented in Subsection 4.4.2, which is improvement of the Numerov method with constant step. So, we obtain two partial solutions for the wave function and their derivatives in the whole studied region (Maydanyuk, 2010). In order to clarify how the proposed approach gives convergent (stable) solutions, we compare our results with the paper of (Acacio de Barros et al., 2007). Let us consider the behavior of the wave function. The first partial solution for the wave function and its derivative in my calculation are presented in Fig. 1, which increase in the tunneling region and have been obtained at different values of the energy of radiation E_{rad} . From these figures one can see that the wave function satisfies the rules satisfied by the wave function inside the sub-barrier and in above-barrier regions (Olkhovsky & Recami, 1992; Olkhovskiy et al., 2004; Zakhariyev et al., 1990). Starting from very small a , the wave function has oscillations and its maxima increase monotonously with increasing of a . This corresponds to the behavior of the wave function in the internal region before the barrier (this becomes more obvious after essential increasing of scale, see left panel in Fig. 2). Moreover, for larger values of a , the wave

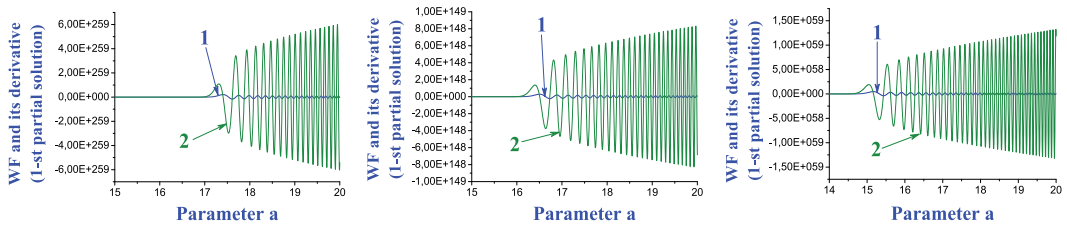

Fig. 1. The first partial solution for the wave function and its derivative at different values of the energy of radiation E_{rad} , increasing in the tunneling region. The blue plot represents the wave function; the green one, the derivative of this wave function): (a) $E_{rad} = 10$; (b) $E_{rad} = 1000$; (c) $E_{rad} = 2000$

function increases monotonously without any oscillation, that points out the transition into the tunneling region (one can see this in a logarithmic presentation of the wave function, see central panel in Fig. 2). A boundary of such a transformation in behavior of the wave function must be the point of penetration of the wave into the barrier, i. e. the internal turning point $a_{tp,in}$. Further, with increasing of a the oscillations appeared in the wave function, which could be possible inside the above barrier region only (in the right panel of Fig. 2 one can see that such a transition is extremely smooth, thing that characterizes the accuracy of the method positively). The boundary of such a transformation in the behavior of the wave function should be the external turning point $a_{tp,out}$. Like Ref. (Maydanyuk, 2008), but at arbitrary non-zero energy E_{rad} we obtain monotonous increasing of maximums of the derivative of the wave function and smooth decreasing of this wave function in the external region. One can see that the derivative is larger than the wave function. At large values of a we obtain the smooth continuous solutions up to $a = 100$ (in Ref. (Acacio de Barros et al., 2007) the maximal presented limit is $a = 30$).

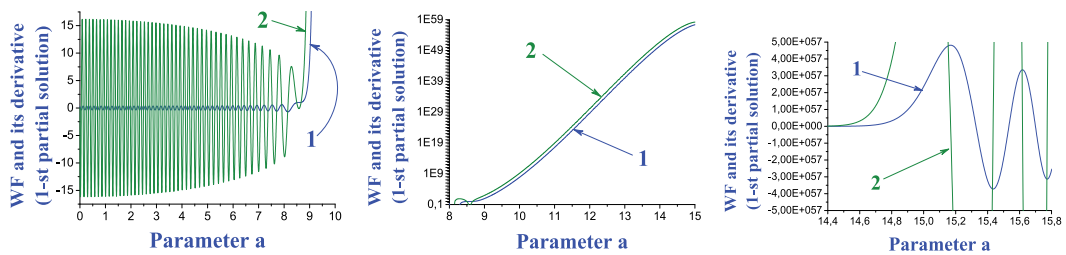

Fig. 2. The first partial solution for the wave function and its derivative at the energy of radiation $E_{rad} = 2000$. The blue line represents the wave function; the green one, the derivative of this wave function)

In Fig. 3, it is presented the second partial solution of the wave function and its derivative at different values of the energy of radiation E_{rad} . According to the analysis, this solution close to the turning points, in the tunneling region, in the sub-barrier and above-barrier regions looks like the first partial solution, but with the difference that now the maxima of the wave function and their derivatives are larger essentially in the external region in a comparison with the internal region, and amplitudes in the tunneling region decrease monotonously.

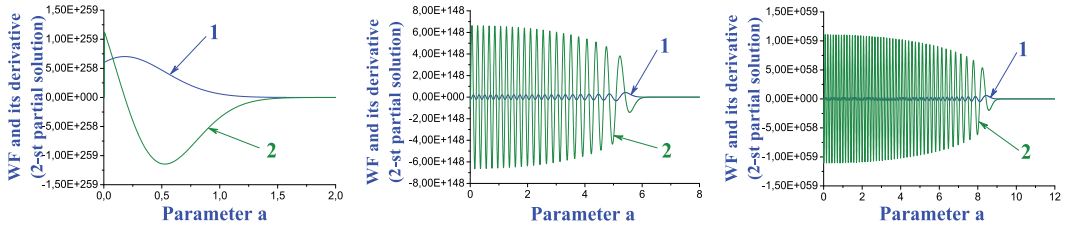

Fig. 3. The second partial solution for the wave function and its derivative at different values of the energy of radiation E_{rad} , decreasing in the tunneling region (the blue line represents the wave function; the green one represents the derivative of this wave function): (a) $E_{\text{rad}} = 10$; (b) $E_{\text{rad}} = 1000$; (c) $E_{\text{rad}} = 2000$

Comparing the previous pictures of the wave function with the results of Ref. (Acacio de Barros et al., 2007), one can see that the wave function, in this approach, is essentially more continuous, has no divergencies and its behavior is everywhere clear. From here we conclude that *the developed method for the determination of the wave function and its derivative at arbitrary energy of radiation is essentially more quick, more stable and accurate in comparison with the non-stationary quantum approach in Ref. (Acacio de Barros et al., 2007)*. Note that:

- With increasing a , the period of the oscillations, both for the wave function and its derivative, decreases uniformly in the external region and increases uniformly in the internal region (this result was partially obtained earlier in Ref. (Maydanyuk, 2008) at $E_{\text{rad}} = 0$).
- At larger distance from the barrier (i. e. for increasing values of a , in the external region, and at decreasing value of a , in the internal region) it becomes more difficult to get the convergent continuous solutions for the wave function and its derivative (this result was partially obtained earlier in Ref. (Maydanyuk, 2008) at $E_{\text{rad}} = 0$).
- *A number of oscillations of the wave function in the internal region increases with increasing of the energy of radiation E_{rad} (this is a new result).*

4.2 Definition of the wave minimally interacting with the potential

Now we shall be looking for a form of the wave function in the external region, which describes accurately the wave, whose propagation is the closest to the “free” one in the external region at the turning point $a_{\text{tp, out}}$ and is directed outside. Let us return back to eq. (16) where the variable $q = a - a_{\text{tp, out}}$ has been introduced. Changing this variable to

$$\xi = |V_1^{(\text{out})}|^{1/3} q, \quad (17)$$

this equation is transformed into

$$\frac{d^2}{d\xi^2} \varphi(\xi) + \xi \varphi(\xi) = 0. \quad (18)$$

From quantum mechanics we know two linearly independent exact solutions for the function $\varphi(\xi)$ in this equation — these are the *Airy functions* $\text{Ai}(\xi)$ and $\text{Bi}(\xi)$ (see Ref. (Abramowitz & Stegun, 1964), p. 264–272, 291–294). Expansions of these functions into power series at small ξ ,

their asymptotic expansions at large $|\xi|$, their representations through Bessel functions, zeroes and their asymptotic expansions are known. We have some integrals of these functions, and also the form of the Airy functions in the semiclassical approximation (which can be applied at large $|\xi|$). In some problems of the analysis of finite solutions $\varphi(\xi)$ in the whole range of ξ it is convenient to use the integral representations of the Airy functions (see eq. (10.4.32) in Ref. (Abramowitz & Stegan, 1964), p. 265. In eq. (10.4.1) we took into account the sign and $a = 1/3$):

$$\begin{aligned} \text{Ai}(\pm\xi) &= \frac{1}{\pi} \int_0^{+\infty} \cos\left(\frac{u^3}{3} \mp \xi u\right) du, \\ \text{Bi}(\pm\xi) &= \frac{1}{\pi} \int_0^{+\infty} \left[\exp\left(-\frac{u^3}{3} \mp \xi u\right) + \sin\left(\frac{u^3}{3} \mp \xi u\right) \right] du. \end{aligned} \quad (19)$$

Furthermore, we shall be interested in the solution $\varphi(\xi)$ which describes the *outgoing wave* in the range of a close to the a_{tp} point. However, it is not clear what the wave represents in general near the point a_{tp} , and which linear combination of the $\text{Ai}(\xi)$ and $\text{Bi}(\xi)$ functions defines it in the most accurate way.

The clearest and most natural understanding of the outgoing wave is given by the semiclassical consideration of the tunneling process. However, at the given potential the semiclassical approach allows us to define the outgoing wave in the asymptotic region only (while we can join solutions in the proximity of a_{tp} by the Airy functions). But it is not clear whether the wave, defined in the asymptotic region, remains outgoing near the a_{tp} . During the whole path of propagation outside the barrier the wave interacts with the potential, and this must inevitably lead to a deformation of its shape (like to appearance of a phase shift in the scattering of a wave by a radial potential caused by interaction in scattering theory). Does the cosmological potentials deform the wave more than the potentials used for description of nuclear collisions in scattering theory? Moreover, for the given potential there is a problem in obtaining the convergence in the calculation of the partial solutions for the wave function in the asymptotic region. According to our calculations, a small change of the range of the definition of the wave in the asymptotic region leads to a significant increase of errors, which requires one to increase the accuracy of the calculations. Therefore, we shall be looking for a way of defining the outgoing wave not in the asymptotic region, but in the closest vicinity of the point of escape, a_{tp} . In a search of solutions close to the point a_{tp} , i. e. at small enough $|\xi|$, the validity of the semiclassical method breaks down as $|\xi|$ approaches zero. Therefore, we shall not use the semiclassical approach in this paper.

Assuming the potential $V(a)$ to have an arbitrary form, we define the wave at the point a_{tp} in the following way (Maydanyuk, 2010).

Definition 1 (strict definition of the wave). *The wave is a linear combination of two partial solutions of the wave function such that the change of the modulus ρ of this wave function is approximately constant under variation of a :*

$$\left. \frac{d^2}{da^2} \rho(a) \right|_{a=a_{tp}} \rightarrow 0. \quad (20)$$

According to this definition, the real and imaginary parts of the total wave function have the closest behaviors under the same variation of a , and the difference between possible

maximums and minimums of the modulus of the total wave function is the smallest. For some types of potentials (in particular, for a rectangular barrier) it is more convenient to define the wave less strongly.

Definition 2 (weak definition of wave):

The wave is a linear combination of two partial solutions of wave function such that the modulus ρ changes minimally under variation of a :

$$\left. \frac{d}{da} \rho(a) \right|_{a=a_{lp}} \rightarrow 0. \quad (21)$$

According to this definition, the change of the wave function caused by variation of a is characterized mainly by its phase (which can characterize the interaction between the wave and the potential).

Subject to this requirement, we shall look for a solution in the following form:

$$\varphi(\xi) = T \cdot \Psi^{(+)}(\xi), \quad (22)$$

where

$$\Psi^{(\pm)}(\xi) = \int_0^{u_{\max}} \exp \pm i \left(-\frac{u^3}{3} + f(\xi)u \right) du. \quad (23)$$

where T is an unknown normalization factor, $f(\xi)$ is an unknown continuous function satisfying $f(\xi) \rightarrow \text{const}$ at $\xi \rightarrow 0$, and u_{\max} is the unknown upper limit of integration. In such a solution, the real part of the function $f(\xi)$ gives a contribution to the phase of the integrand function, while the imaginary part of $f(\xi)$ deforms its modulus.

Let us find the first and second derivatives of the function $\Psi(\xi)$ (a prime denotes a derivative with respect to ξ):

$$\begin{aligned} \frac{d}{d\xi} \Psi^{(\pm)}(\xi) &= \pm we \int_0^{u_{\max}} f' u \exp \pm i \left(-\frac{u^3}{3} + f(\xi)u \right) du, \\ \frac{d^2}{d\xi^2} \Psi^{(\pm)}(\xi) &= \int_0^{u_{\max}} \left(\pm i f'' u - (f')^2 u^2 \right) \exp \pm i \left(-\frac{u^3}{3} + f(\xi)u \right) du. \end{aligned} \quad (24)$$

From this we obtain:

$$\frac{d^2}{d\xi^2} \Psi^{(\pm)}(\xi) + \xi \Psi^{(\pm)}(\xi) = \int_0^{u_{\max}} \left(\pm i f'' u - (f')^2 u^2 + \xi \right) \exp \pm i \left(-\frac{u^3}{3} + f(\xi)u \right) du. \quad (25)$$

Considering the solutions at small enough values of $|\xi|$, we represent $f(\xi)$ in the form of a power series:

$$f(\xi) = \sum_{n=0}^{+\infty} f_n \xi^n, \quad (26)$$

where f_n are constant coefficients. The first and second derivatives of $f(\xi)$ are

$$\begin{aligned} f'(\xi) &= \frac{d}{d\xi} f(\xi) = \sum_{n=1}^{+\infty} n f_n \xi^{n-1} = \sum_{n=0}^{+\infty} (n+1) f_{n+1} \xi^n, \\ f''(\xi) &= \frac{d^2}{d\xi^2} f(\xi) = \sum_{n=0}^{+\infty} (n+1)(n+2) f_{n+2} \xi^n. \end{aligned} \tag{27}$$

Substituting these solutions into eq. (24), we obtain

$$\begin{aligned} \frac{d^2}{d\xi^2} \Psi^{(\pm)}(\xi) + \xi \Psi^{(\pm)}(\xi) &= \int_0^{u_{\max}} \left\{ (\pm 2iu f_2 - u^2 f_1^2) + \right. \\ &+ (\pm 6iu f_3 - 4u^2 f_1 f_2 + 1) \xi + \left. \sum_{n=2}^{+\infty} [\pm iu (n+1)(n+2) f_{n+2} - \right. \\ &\left. - u^2 \sum_{m=0}^n (n-m+1)(m+1) f_{n-m+1} f_{m+1}] \xi^n \right\} \exp \pm i \left(-\frac{u^3}{3} + fu \right) du. \end{aligned} \tag{28}$$

Considering this expression at small $|\xi|$, we use the following approximation:

$$\exp \pm i \left(-\frac{u^3}{3} + fu \right) \rightarrow \exp \pm i \left(-\frac{u^3}{3} + f_0 u \right). \tag{29}$$

Then from eq. (18) we obtain the following condition for the unknown f_n :

$$\begin{aligned} &\int_0^{u_{\max}} (\pm 2iu f_2 - u^2 f_1^2) \exp \pm i \left(-\frac{u^3}{3} + f_0 u \right) du + \\ &+ \xi \cdot \int_0^{u_{\max}} (\pm 6iu f_3 - 4u^2 f_1 f_2 + 1) \exp \pm i \left(-\frac{u^3}{3} + f_0 u \right) du + \\ &+ \sum_{n=2}^{+\infty} \xi^n \cdot \int_0^{u_{\max}} \left[\pm iu (n+1)(n+2) f_{n+2} - u^2 \sum_{m=0}^n (n-m+1)(m+1) f_{n-m+1} f_{m+1} \right] \times \\ &\quad \times \exp \pm i \left(-\frac{u^3}{3} + f_0 u \right) du = 0. \end{aligned} \tag{30}$$

Requiring that this condition is satisfied for different ξ and with different powers n , we obtain the following system:

$$\begin{aligned} \xi^0 : &\quad \int_0^{u_{\max}} (\pm 2iu f_2 - u^2 f_1^2) \exp \pm i \left(-\frac{u^3}{3} + f_0 u \right) du = 0, \\ \xi^1 : &\quad \int_0^{u_{\max}} (\pm 6iu f_3 - 4u^2 f_1 f_2 + 1) \exp \pm i \left(-\frac{u^3}{3} + f_0 u \right) du = 0, \\ \xi^n : &\quad \int_0^{u_{\max}} \left[\pm iu (n+1)(n+2) f_{n+2} - u^2 \sum_{m=0}^n (n-m+1)(m+1) f_{n-m+1} f_{m+1} \right] \times \\ &\quad \times \exp \pm i \left(-\frac{u^3}{3} + f_0 u \right) du = 0. \end{aligned} \tag{31}$$

Assuming that the coefficients f_0 and f_1 are known, we find the following solutions for the unknown f_2 , f_3 and f_n :

$$f_2^{(\pm)} = \pm \frac{f_1^2}{2i} \cdot \frac{J_2^{(\pm)}}{J_1^{(\pm)}}, f_3^{(\pm)} = \pm \frac{4f_1 f_2^{(\pm)} J_2^{(\pm)} - J_0^{(\pm)}}{6i J_1^{(\pm)}}, \quad (32)$$

$$f_{n+2}^{(\pm)} = \frac{\sum_{m=0}^n (n-m+1)(m+1) f_{n-m+1}^{(\pm)} f_{m+1}^{(\pm)}}{i(n+1)(n+2)} \cdot \frac{J_2^{(\pm)}}{J_1^{(\pm)}}, \quad (33)$$

where the following notations for the integrals have been introduced:

$$J_0^{(\pm)} = \int_0^{u_{\max}} \exp \pm i \left(-\frac{u^3}{3} + f_0 u \right) du, J_1^{(\pm)} = \int_0^{u_{\max}} u \exp \pm i \left(-\frac{u^3}{3} + f_0 u \right) du, \quad (34)$$

$$J_2^{(\pm)} = \int_0^{u_{\max}} u^2 e^{\pm i \left(-\frac{u^3}{3} + f_0 u \right)} du. \quad (35)$$

Thus, we see that the solution (22) taking into account eq. (23) for the function $\varphi(\xi)$ has arbitrariness in the choice of the unknown coefficients f_0 , f_1 and the upper limit of integration, u_{\max} . However, the solutions found, eqs. (32), define the function $f(\xi)$ so as to ensure that the equality (22) is exactly satisfied in the region of a close to the escape point a_{tp} . This proves that the function $\varphi(\xi)$ in the form (22), taking into account eq. (23) for an arbitrary choice of f_0 , f_1 and u_{\max} is the exact solution of the Schrödinger equation near the escape point a_{tp} . In order to write the solution $\Psi(\xi)$ in terms of the well-known Airy functions, Ai (ξ) and Bi (ξ) , we choose

$$f_0 = 0, f_1 = 1. \quad (36)$$

For such a choice of the coefficients f_0 and f_1 , the integrand function in the solution (23) (up to ξ^2) has a constant modulus and a varying phase. Therefore, one can expect that the solution (22) at the turning point a_{tp} describes the wave accurately.

4.3 Total wave function

Having obtained two linearly independent partial solutions $\varphi_1(a)$ and $\varphi_2(a)$, we can write the general solution (a prime is for the derivative with respect to a) as:

$$\varphi(a) = T \cdot (C_1 \varphi_1(a) + C_2 \varphi_2(a)), \quad (37)$$

$$C_1 = \frac{\Psi \varphi_2' - \Psi' \varphi_2}{\varphi_1 \varphi_2' - \varphi_1' \varphi_2} \Big|_{a=a_{tp, out}},$$

$$C_2 = \frac{\Psi' \varphi_1 - \Psi \varphi_1'}{\varphi_1 \varphi_2' - \varphi_1' \varphi_2} \Big|_{a=a_{tp, out}}, \quad (38)$$

where T is a normalization factor, C_1 and C_2 are complex constants found from the boundary condition introduced above: the $\varphi(a)$ function should represent an outgoing wave at turning point $a_{tp, out}$.

Fig. 4 plots the total wave function calculated in this way for the potential (12) with parameters $A = 36$, $B = 12 \Lambda$ at $\Lambda = 0.01$ at different values of the energy of radiation E_{rad} . One can

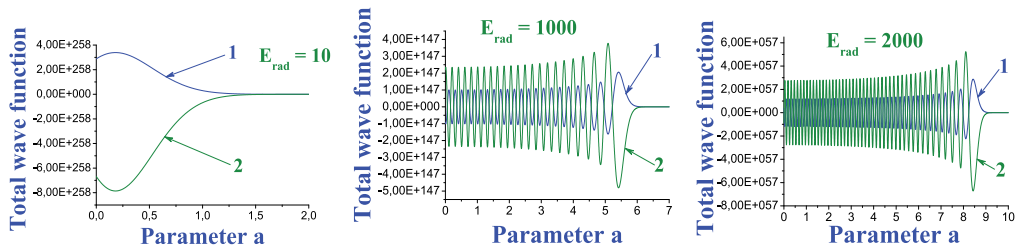

Fig. 4. The wave function at selected values of the energy of radiation E_{rad} (the blue line, represents the real part of the wave function; the green line the imaginary part of the wave function): (a) $E_{\text{rad}} = 10$; (b) $E_{\text{rad}} = 1000$; (c) $E_{\text{rad}} = 2000$

see that the number of oscillations of the wave function in the internal region increases with increasing of the energy of radiation. Another interesting property are *the larger maxima of the wave function in the internal region at smaller distances to the barrier for arbitrary energy* (result found for the first time).

In Fig. 5 it has been shown how the modulus of this wave function changes at selected values of the energy of radiation. From these figures it becomes clear why the coefficient

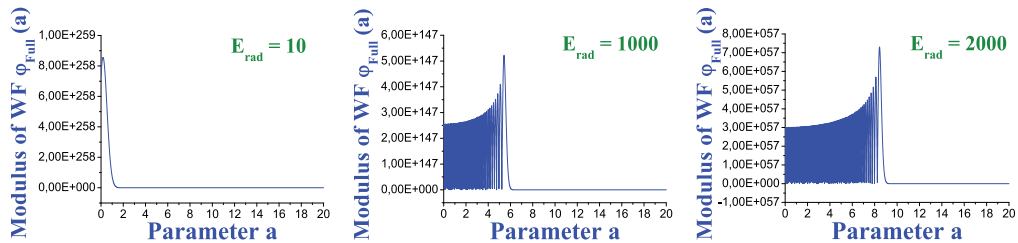

Fig. 5. The behavior of the modulus of the wave function at the selected energies of radiation E_{rad} : (a) $E_{\text{rad}} = 10$; (b) $E_{\text{rad}} = 1000$; (c) $E_{\text{rad}} = 2000$.

of penetrability of the barrier is extremely small (up to the energy $E_{\text{rad}} = 2000$). In order to estimate, how effective is the boundary condition introduced above in building up the wave on the basis of the total wave function close to the external turning point $a_{\text{tp,out}}$, it is useful to see how the modulus of this wave function changes close to this point. In Fig. 6 we plot the modulus of the found wave function close to the turning points at the energy of radiation $E_{\text{rad}} = 2000$ is shown. Here, one can see that the modulus at $a_{\text{tp,out}}$ is practically constant (see left panel in Fig. 6). It is interesting to note that the modulus of the wave function, previously defined, does not change close to the internal turning point $a_{\text{tp,in}}$, and is close to maximum (see right panel in Fig. 6).

4.4 Calculations of the wave function of Universe

4.4.1 Method of calculations of the wave function close to an arbitrary selected point a_x

Here, we look for the regular partial solution of the wave function close to an arbitrary selected point a_x . Let us write the wave function in the form:

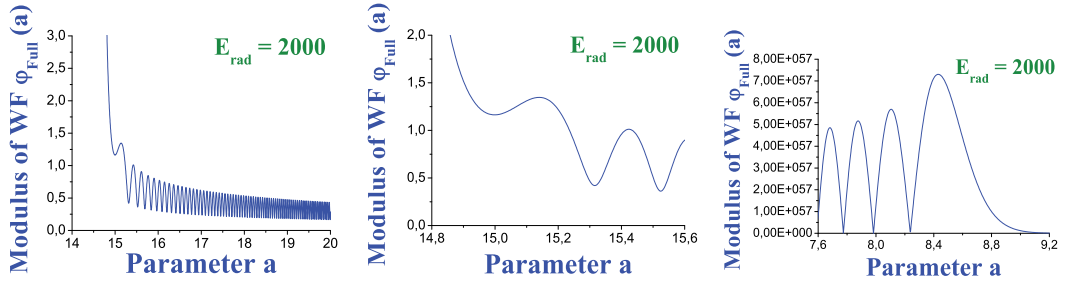

Fig. 6. The behavior of the modulus of the total wave function at the energy of radiation $E_{\text{rad}} = 2000$, close to the turning points (for $a_{\text{tp},\text{in}} = 8.58$, $a_{\text{tp},\text{out}} = 15.04$, see also Table 1): (a) the modulus decreases monotonously in the tunneling region, with increasing of a . It shows maxima and holes connected with the oscillations of the wave function in the external region, but the modulus is not equal to zero (this points out the existence of a non-zero flux); (b) when a increases, the modulus reaches a minimum close to the external turning point $a_{\text{tp},\text{out}}$ (this demonstrates the practical fulfillment of the definition for the wave at such a point); (c) transition close to $a_{\text{tp},\text{in}}$ is shown, where at increasing of a the modulus with maximums and holes is transformed rapidly into a monotonously decreasing function without maximums and holes. This is connected with transition to the region of tunneling.

$$\varphi(a) = c_2 \sum_{n=0}^{+\infty} b_n (a - a_x)^n = c_2 \sum_{n=0}^{+\infty} b_n \bar{a}^n, \quad (39)$$

$$\bar{a} = a - a_x$$

and rewrite the potential through the variable \bar{a} :

$$V(a) = C_0 + C_1 \bar{a} + C_2 \bar{a}^2 + C_3 \bar{a}^3 + C_4 \bar{a}^4, \quad (40)$$

where

$$\begin{aligned} C_0 &= A a_x^2 - B a_x^4, \\ C_1 &= 2a_x(A - B a_x^2) - 2B a_x^3 = 2A a_x - 4B a_x^3, \\ C_2 &= A - B a_x^2 - 4B a_x^2 - B a_x^2 = A - 6B a_x^2, \\ C_3 &= -2B a_x - 2B a_x = -4B a_x, \\ C_4 &= -B. \end{aligned} \quad (41)$$

Substituting the wave function (39), its second derivative and the potential (40) into Schrödinger equation, we obtain recurrent relations for unknown b_n :

$$b_2 = \frac{(C_0 - E) b_0}{2}, \quad b_3 = \frac{(C_0 - E) b_1 + C_1 b_0}{6}, \quad b_4 = \frac{(C_0 - E) b_2 + C_1 b_1 + C_2 b_0}{12}, \quad (42)$$

$$b_5 = \frac{(C_0 - E) b_3 + C_1 b_2 + C_2 b_1 + C_3 b_0}{20}, \quad (43)$$

$$b_{n+2} = \frac{(C_0 - E) b_n + C_1 b_{n-1} + C_2 b_{n-2} + C_3 b_{n-3} + C_4 b_{n-4}}{(n+1)(n+2)} \quad \text{at } n \geq 4. \quad (44)$$

Given the values of b_0 and b_1 and using eqs. (42)–(44) one can calculate all b_n needed. At limit $E_{\text{rad}} \rightarrow 0$ and at $a_x = 0$ all found solutions for b_i transform into the corresponding solutions (40), early obtained in (Maydanyuk, 2008) at $E_{\text{rad}} = 0$. Using $c_2 = 1$, from eqs. (39) we find:

$$b_0 = \varphi(a_x), b_1 = \varphi'(a_x). \quad (45)$$

So, on the basis of the coefficients b_0 and b_1 one can obtain the values of the wave function and its derivative at point a_x . Imposing two different boundary conditions via b_0 and b_1 , we obtain two linearly independent partial solutions $\varphi_1(a)$ and $\varphi_2(a)$ for the wave function. Using the internal turning point $a_{\text{tp},\text{in}}$ as the starting point, we calculate the first partial solution which increases in the barrier region (we choose: $b_0 = 0.1, b_1 = 1$), and using the external turning point $a_{\text{tp},\text{out}}$ as the starting point, we calculate the second partial solution which decreases in the barrier region (we choose: $b_0 = 1, b_1 = -0.1$). Such a choice provides effectively a linear independence between two partial solutions.

4.4.2 Method of continuation of the solution

Let us rewrite equation (18) in such a form²:

$$\varphi''(a) = f(a) \varphi(a). \quad (46)$$

Let $\{a_n\}$ be a set of equidistant points $a_n = a_0 + nh$. Denoting the values of the wave function $\varphi(a)$ at points a_n as φ_n , we have constructed an algorithm of the ninth order to determine φ_{n+1} and φ'_n when φ_n and φ_{n-1} are known:

$$\begin{aligned} \varphi_{n+1} &= \varphi_{n-1} \frac{g_{11} + g_{01}}{g_{01} - g_{11}} + \varphi_n \frac{g_{01} g_{10} - g_{00} g_{11}}{g_{01} - g_{11}} + O(h^9), \\ \varphi'_n &= \varphi_{n-1} \frac{2}{g_{01} - g_{11}} + \varphi_n \frac{g_{10} - g_{00}}{g_{01} - g_{11}} + O(h^9), \end{aligned} \quad (47)$$

where

$$\begin{aligned} g_{00} &= 2 + h^2 f_n + \frac{2}{4!} h^4 (f_n'' + f_n^2) + \frac{2}{6!} h^6 (f_n^{(4)} + 4(f_n')^2 + 7f_n f_n'' + f_n^3) + \\ &+ \frac{2}{8!} h^8 (f_n^{(6)} + 16f_n f_n^{(4)} + 26f_n' f_n^{(3)} + 15(f_n'')^2 + 22f_n^2 f_n'' + 28f_n (f_n')^2 + f_n^4), \\ g_{01} &= \frac{2}{4!} h^4 2f_n' + \frac{2}{6!} h^6 (4f_n^{(3)} + 6f_n f_n') + \frac{2}{8!} h^8 (6f_n^{(5)} + 24f_n f_n^{(3)} + 48f_n' f_n'' + 12f_n^2 f_n'), \\ g_{10} &= \frac{2}{3!} h^3 f_n' + \frac{2}{5!} h^5 (f_n^{(3)} + 4f_n f_n') + \frac{2}{7!} h^7 (f_n^{(5)} + 11f_n f_n^{(3)} + 15f_n' f_n'' + 9f_n^2 f_n'), \\ g_{11} &= 2h + \frac{2}{3!} h^3 f_n + \frac{2}{5!} h^5 (3f_n'' + f_n^2) + \frac{2}{7!} h^7 (5f_n^{(4)} + 13f_n f_n'' + 10(f_n')^2 + f_n^3). \end{aligned} \quad (48)$$

A local error of these formulas at point a_n equals to:

$$\delta_n = \frac{1}{10!} h^{10} f_n' \varphi_n^{(7)}. \quad (49)$$

² Here, we used the algorithm of (Zaichenko & Kashuba, 2001)

4.5 The penetrability and reflection in the fully quantum approach

Let us analyze whether a known wave function in the whole region of its definition allows us to determine uniquely the coefficients of penetrability and reflection.

4.5.1 Problem of interference between the incident and reflected waves

Rewriting the wave function φ_{total} in the internal region through a summation of incident φ_{inc} wave and reflected φ_{ref} wave:

$$\varphi_{\text{total}} = \varphi_{\text{inc}} + \varphi_{\text{ref}}, \quad (50)$$

we consider the total flux:

$$j(\varphi_{\text{total}}) = i \left[\left(\varphi_{\text{inc}} + \varphi_{\text{ref}} \right) \nabla \left(\varphi_{\text{inc}}^* + \varphi_{\text{ref}}^* \right) - \text{h. c.} \right] = j_{\text{inc}} + j_{\text{ref}} + j_{\text{mixed}}, \quad (51)$$

where

$$\begin{aligned} j_{\text{inc}} &= i \left(\varphi_{\text{inc}} \nabla \varphi_{\text{inc}}^* - \text{h. c.} \right), \\ j_{\text{ref}} &= i \left(\varphi_{\text{ref}} \nabla \varphi_{\text{ref}}^* - \text{h. c.} \right), \\ j_{\text{mixed}} &= i \left(\varphi_{\text{inc}} \nabla \varphi_{\text{ref}}^* + \varphi_{\text{ref}} \nabla \varphi_{\text{inc}}^* - \text{h. c.} \right). \end{aligned} \quad (52)$$

The j_{mixed} component describes interference between the incident and reflected waves in the internal region (let us call it *mixed component of the total flux* or simply *flux of mixing*). From the constancy of the total flux j_{total} we find the flux j_{tr} for the wave transmitted through the barrier, and:

$$j_{\text{inc}} = j_{\text{tr}} - j_{\text{ref}} - j_{\text{mixed}}, \quad j_{\text{tr}} = j_{\text{total}} = \text{const.} \quad (53)$$

Now one can see that *the mixed flux introduces ambiguity in the determination of the penetrability and reflection for the same known wave function*.

4.6 Determination of the penetrability, reflection and interference coefficients

In quantum mechanics the coefficients of penetrability and reflection are defined considering the potential as a whole, including asymptotic regions. However, in the radial calculation of quantum decay such a consideration depends on how the incident and reflected waves are defined inside finite internal region from the left of the barrier. The question is: does the location of such a region influence the penetrability and reflection? In order to obtain these coefficients, we shall include into definitions coordinates where the fluxes are defined (denote them as x_{left} and x_{right}):

$$\begin{aligned} T(x_{\text{left}}, x_{\text{right}}) &= \frac{j_{\text{tr}}(x_{\text{right}})}{j_{\text{inc}}(x_{\text{left}})}, \\ R(x_{\text{left}}) &= \frac{j_{\text{ref}}(x_{\text{left}})}{j_{\text{inc}}(x_{\text{left}})}, \\ M(x_{\text{left}}) &= \frac{j_{\text{mixed}}(x_{\text{left}})}{j_{\text{inc}}(x_{\text{left}})}. \end{aligned} \quad (54)$$

So, the T and R coefficients determine the probability of transmission (or tunneling) and reflection of the wave relatively the region of the potential with arbitrary selected boundaries $x_{\text{left}}, x_{\text{right}}$. When x_{right} tends to the asymptotic limit, the coefficient defined before should transform into standard ones. Assuming that j_{tr} and j_{ref} are directed in opposite directions,

j_{inc} and j_{tr} — in the same directions, from eqs. (53) and (54) we obtain (Maydanyuk, 2010):

$$|T| + |R| - M = 1. \quad (55)$$

Now we see that the condition $|T| + |R| = 1$ has sense in quantum mechanics only if there is no interference between incident and reflected waves, and for this is enough that:

$$j_{\text{mixed}} = 0. \quad (56)$$

A new question appears: *does this condition allow to separate the total wave function into the incident and reflected components in a unique way?* It turns out that the choice of the incident and reflected waves has essential influence on the barrier penetrability, and different forms of the incident φ_{inc} and reflected φ_{ref} waves can give zero flux j_{mix} . Going from the rectangular internal well to the fully quantum treatment of the problem would become more complicated.

4.7 Wave incident on the barrier and wave reflected from it in the internal region

One can define the incident wave to be proportional to the function $\Psi^{(+)}$ and the reflected wave to be proportional to the function $\Psi^{(-)}$:

$$\begin{aligned} \varphi_{\text{total}}(a) &= \varphi_{\text{inc}}(a) + \varphi_{\text{ref}}(a), \\ \varphi_{\text{inc}}(a) &= we \cdot \Psi^{(+)}(a), \\ \varphi_{\text{ref}}(a) &= R \cdot \Psi^{(-)}(a), \end{aligned} \quad (57)$$

where I and R are new constants found from continuity condition of the total wave function φ_{total} and its derivative at the internal turning point $a_{\text{tp,int}}$:

$$\begin{aligned} we &= \frac{\varphi_{\text{total}} \Psi^{(-)'} - \varphi_{\text{total}}' \Psi^{(-)}}{\Psi^{(+)} \Psi^{(-)'} - \Psi^{(+)' } \Psi^{(-)}} \Big|_{a=a_{\text{tp,int}}}, \\ R &= \frac{\varphi_{\text{total}}' \Psi^{(+)} - \varphi_{\text{total}} \Psi^{(+)'}}{\Psi^{(+)} \Psi^{(-)'} - \Psi^{(+)' } \Psi^{(-)}} \Big|_{a=a_{\text{tp,int}}}. \end{aligned} \quad (58)$$

On the basis of these solutions we obtain at the internal turning point $a_{\text{tp,int}}$ the flux incident on the barrier, the flux reflected from it and the flux of mixing. The flux transmitted through the barrier was calculated at the external turning point $a_{\text{tp,ext}}$.

4.8 Penetrability and reflection: fully quantum approach versus semiclassical one

Now we shall estimate through the method described above the coefficients of penetrability and reflection for the potential barrier with parameters $A = 36$, $B = 12\Lambda$, $\Lambda = 0.01$ at different values of the energy of radiation E_{rad} . We shall compare the coefficient of penetrability obtained with the values given by the semiclassical method. In the semiclassical approach we shall consider two definitions of this coefficient:

$$P_{\text{penetrability}}^{\text{WKB}(1)} = \frac{1}{\theta^2}, P_{\text{penetrability}}^{\text{WKB}(2)} = \frac{4}{(2\theta + 1/(2\theta)^2)^2}, \quad (59)$$

where

$$\theta = \exp \int_{a_{\text{tp}}^{(\text{int})}}^{a_{\text{tp}}^{(\text{ext})}} |V(a) - E| da. \quad (60)$$

One can estimate also *the duration of the formation of the Universe*, using by definition (15) in Ref. (Acacio de Barros et al., 2007):

$$\tau = 2 a_{\text{tp, int}} \frac{1}{P_{\text{penetrability}}}. \quad (61)$$

The results are presented in Tabl. 1. In calculations the coefficients of penetrability, reflection and mixing are defined by eqs. (54), the fluxes by eqs. (52) (calculated $P_{\text{penetrability}}^{\text{WKB},(2)}$ coincide with $P_{\text{penetrability}}^{\text{WKB},(1)}$ up to the first 7 digits for energies in range $0 \leq E_{\text{rad}} \leq 2500$).

From this table one can see that inside the entire range of energy, the fully quantum approach gives value for the coefficient of penetrability enough close to its value obtained by the semiclassical approach. This differs essentially from results in the non-stationary approach (Acacio de Barros et al., 2007). This difference could be explained by difference in a choice of the boundary condition, which is used in construction of the stationary solution of the wave function.

4.9 The penetrability in the FRW-model with the Chaplygin gas

In order to connect universe with dust and its accelerating stage, in Ref. (Kamenshchik et al., 2001) a new scenario with the *Chaplygin gas* was proposed. A quantum FRW-model with the Chaplygin gas has been constructed on the basis of equation of state instead of $p(a) = \rho_{\text{rad}}(a)/3$ (where $p(a)$ is pressure) by the following (see also Refs. (Bento et al., 2002; Bilic et al., 2002)):

$$p_{\text{Ch}} = -\frac{A}{\rho_{\text{Ch}}^\alpha}, \quad (62)$$

where A is positive constant and $0 < \alpha \leq 1$. In particular, for the standard Chaplygin gas we have $\alpha = 1$. Solution of equation of state (62) gives the following dependence of density on the scale factor:

$$\rho_{\text{Ch}}(a) = \left(A + \frac{B}{a^{3(1+\alpha)}} \right)^{1/(1+\alpha)}, \quad (63)$$

where B is a new constant of integration. Using the parameter α , this model describes transition between the stage, when Universe is filled with dust-like matter, and its accelerating expanding stage (through scenario of Chaplygin gas applied to cosmology, for details, see Refs. (Bouhmadi-Lopez & Moniz, 2005; Bouhmadi-Lopez et al., 2008; Kamenshchik et al., 2001), also historical paper (Chaplygin, 1904)).

Let us combine expression for density which includes previous forms of matter and the Chaplygin gas in addition. At limit $\alpha \rightarrow 0$ eq. (63) transforms into the ρ_{dust} component plus the ρ_Λ component. From such limit we find

$$A = \rho_\Lambda, B = \rho_{\text{dust}} \quad (64)$$

Energy E_{rad}	Penetrability $P_{\text{penetrability}}$		Time τ		Turning points	
	Direct method	Method WKB	Direct method	Method WKB	$a_{\text{tp,in}}$	$a_{\text{tp,out}}$
1.0	8.7126×10^{-521}	2.0888×10^{-521}	$3.8260 \times 10^{+519}$	$1.5958 \times 10^{+520}$	0.16	17.31
2.0	2.4225×10^{-520}	5.5173×10^{-521}	$1.9460 \times 10^{+519}$	$8.5448 \times 10^{+519}$	0.23	17.31
3.0	6.2857×10^{-520}	1.3972×10^{-520}	$9.1863 \times 10^{+518}$	$4.1326 \times 10^{+519}$	0.28	17.31
4.0	1.5800×10^{-519}	3.4428×10^{-520}	$4.2201 \times 10^{+518}$	$1.9367 \times 10^{+519}$	0.33	17.31
5.0	3.8444×10^{-519}	8.2935×10^{-520}	$1.9392 \times 10^{+518}$	$8.9892 \times 10^{+518}$	0.37	17.31
6.0	9.2441×10^{-519}	1.9701×10^{-519}	$8.8350 \times 10^{+517}$	$4.1455 \times 10^{+518}$	0.40	17.31
7.0	2.1678×10^{-518}	4.5987×10^{-519}	$4.0694 \times 10^{+517}$	$1.9183 \times 10^{+518}$	0.44	17.31
8.0	5.0192×10^{-518}	1.0621×10^{-518}	$1.8790 \times 10^{+517}$	$8.8797 \times 10^{+517}$	0.47	17.31
9.0	1.1604×10^{-517}	2.4316×10^{-518}	$8.6212 \times 10^{+516}$	$4.1140 \times 10^{+517}$	0.50	17.31
10.0	2.6279×10^{-517}	5.5016×10^{-518}	$4.0128 \times 10^{+516}$	$1.9168 \times 10^{+517}$	0.52	17.31
100.0	1.6165×10^{-490}	3.1959×10^{-491}	$2.0717 \times 10^{+490}$	$1.0478 \times 10^{+491}$	1.67	17.23
200.0	8.5909×10^{-465}	1.6936×10^{-465}	$5.5397 \times 10^{+464}$	$2.8100 \times 10^{+465}$	2.37	17.15
300.0	6.8543×10^{-441}	1.3419×10^{-441}	$8.5461 \times 10^{+440}$	$4.3653 \times 10^{+441}$	2.92	17.07
400.0	3.6688×10^{-418}	7.1642×10^{-419}	$1.8531 \times 10^{+418}$	$9.4900 \times 10^{+418}$	3.39	16.98
500.0	2.6805×10^{-396}	5.2521×10^{-397}	$2.8508 \times 10^{+396}$	$1.4550 \times 10^{+397}$	3.82	16.89
600.0	4.1386×10^{-375}	8.0511×10^{-376}	$2.0338 \times 10^{+375}$	$1.0454 \times 10^{+376}$	4.20	16.80
700.0	1.7314×10^{-354}	3.3810×10^{-355}	$5.2806 \times 10^{+354}$	$2.7043 \times 10^{+355}$	4.57	16.70
800.0	2.4308×10^{-334}	4.7497×10^{-335}	$4.0448 \times 10^{+334}$	$2.0701 \times 10^{+335}$	4.91	16.60
900.0	1.3213×10^{-314}	2.5761×10^{-315}	$7.9408 \times 10^{+314}$	$4.0730 \times 10^{+315}$	5.24	16.50
1000.0	3.0920×10^{-295}	6.0272×10^{-296}	$3.5999 \times 10^{+295}$	$1.8468 \times 10^{+296}$	5.56	16.40
1100.0	3.4274×10^{-276}	6.6576×10^{-277}	$3.4289 \times 10^{+276}$	$1.7652 \times 10^{+277}$	5.87	16.29
1200.0	1.9147×10^{-257}	3.7259×10^{-258}	$6.4553 \times 10^{+257}$	$3.3174 \times 10^{+258}$	6.18	16.18
1300.0	5.8026×10^{-239}	1.1253×10^{-239}	$2.2333 \times 10^{+239}$	$1.1516 \times 10^{+240}$	6.47	16.06
1400.0	9.9042×10^{-221}	1.9252×10^{-221}	$1.3683 \times 10^{+221}$	$7.0393 \times 10^{+221}$	6.77	15.93
1500.0	1.0126×10^{-202}	1.9551×10^{-203}	$1.3965 \times 10^{+203}$	$7.2333 \times 10^{+203}$	7.07	15.81
1600.0	6.2741×10^{-185}	1.2155×10^{-185}	$2.3480 \times 10^{+185}$	$1.2119 \times 10^{+186}$	7.36	15.67
1700.0	2.4923×10^{-167}	4.8143×10^{-168}	$6.1488 \times 10^{+167}$	$3.1831 \times 10^{+168}$	7.66	15.53
1800.0	6.4255×10^{-150}	1.2437×10^{-150}	$2.4783 \times 10^{+150}$	$1.2803 \times 10^{+151}$	7.96	15.38
1900.0	1.1189×10^{-132}	2.1580×10^{-133}	$1.4776 \times 10^{+133}$	$7.6619 \times 10^{+133}$	8.26	15.22
2000.0	1.3288×10^{-115}	2.5653×10^{-116}	$1.2914 \times 10^{+116}$	$6.6895 \times 10^{+116}$	8.58	15.04
2100.0	1.1105×10^{-98}	2.1357×10^{-99}	$1.6036 \times 10^{+99}$	$8.3382 \times 10^{+99}$	8.90	14.85
2200.0	6.6054×10^{-82}	1.2690×10^{-82}	$2.7988 \times 10^{+82}$	$1.4567 \times 10^{+83}$	9.24	14.64
2300.0	2.8693×10^{-65}	5.4647×10^{-66}	$6.6952 \times 10^{+65}$	$3.5154 \times 10^{+66}$	9.60	14.41
2400.0	9.1077×10^{-49}	1.7297×10^{-49}	$2.1959 \times 10^{+49}$	$1.1562 \times 10^{+50}$	10.00	14.14
2500.0	2.1702×10^{-32}	4.0896×10^{-33}	$9.6290 \times 10^{+32}$	$5.1098 \times 10^{+33}$	10.44	13.81
2600.0	3.9788×10^{-16}	7.3137×10^{-17}	$5.5322 \times 10^{+16}$	$3.0096 \times 10^{+17}$	11.00	13.37
2610.0	1.6663×10^{-14}	3.0428×10^{-15}	$1.3290 \times 10^{+15}$	$7.2780 \times 10^{+15}$	11.07	13.31
2620.0	6.9240×10^{-13}	1.2606×10^{-13}	$3.2187 \times 10^{+13}$	$1.7678 \times 10^{+14}$	11.14	13.25
2630.0	2.8842×10^{-11}	5.2116×10^{-12}	$7.7789 \times 10^{+11}$	$4.3050 \times 10^{+12}$	11.21	13.19
2640.0	1.2002×10^{-9}	2.1495×10^{-10}	$1.8825 \times 10^{+10}$	$1.0511 \times 10^{+11}$	11.29	13.12
2650.0	4.9881×10^{-8}	8.8401×10^{-9}	$4.5642 \times 10^{+8}$	$2.5754 \times 10^{+9}$	11.38	13.05
2660.0	2.0738×10^{-6}	3.6263×10^{-7}	$1.1068 \times 10^{+7}$	$6.3303 \times 10^{+7}$	11.47	12.97
2670.0	8.7110×10^{-5}	1.4836×10^{-5}	$2.6596 \times 10^{+5}$	$1.5615 \times 10^{+6}$	11.58	12.87
2680.0	3.6953×10^{-3}	6.0519×10^{-4}	$6.3369 \times 10^{+3}$	$3.8693 \times 10^{+4}$	11.70	12.76
2690.0	1.5521×10^{-1}	2.4634×10^{-2}	$1.5293 \times 10^{+2}$	$9.3602 \times 10^{+2}$	11.86	12.61

Table 1. The penetrability $P_{\text{penetrability}}$ of the barrier and the duration τ of the formation of the Universe defined by eq. (61) in the fully quantum and semiclassical approaches

and obtain the following generalized density:

$$\rho(a) = \left(\rho_\Lambda + \frac{\rho_{\text{dust}}}{a^{3(1+\alpha)}} \right)^{1/(1+\alpha)} + \frac{\rho_{\text{rad}}}{a^4(t)}. \tag{65}$$

Now we have:

$$\dot{a}^2 + k - \frac{8\pi G}{3} \left\{ a^2 \left(\rho_\Lambda + \frac{\rho_{\text{dust}}}{a^{3(1+\alpha)}} \right)^{1/(1+\alpha)} + \frac{\rho_{\text{rad}}}{a^2(t)} \right\} = 0. \tag{66}$$

After quantization we obtain the Wheeler-De Witt equation

$$\left\{ -\frac{\partial^2}{\partial a^2} + V_{\text{Ch}}(a) \right\} \varphi(a) = E_{\text{rad}} \varphi(a), \quad E_{\text{rad}} = \frac{3\rho_{\text{rad}}}{2\pi G}, \tag{67}$$

where

$$V_{\text{Ch}}(a) = \left(\frac{3}{4\pi G} \right)^2 k a^2 - \frac{3}{2\pi G} a^4 \left(\rho_\Lambda + \frac{\rho_{\text{dust}}}{a^{3(1+\alpha)}} \right)^{1/(1+\alpha)}. \tag{68}$$

For the Universe of closed type (at $k = 1$) at $8\pi G \equiv M_p^{-2} = 1$ we have (see eqs. (6)–(7) in Ref. (Bouhmadi-Lopez & Moniz, 2005)):

$$V_{\text{Ch}}(a) = 36 a^2 - 12 a^4 \left(\Lambda + \frac{\rho_{\text{dust}}}{a^{3(1+\alpha)}} \right)^{1/(1+\alpha)}, \quad E_{\text{rad}} = 12 \rho_{\text{rad}}. \tag{69}$$

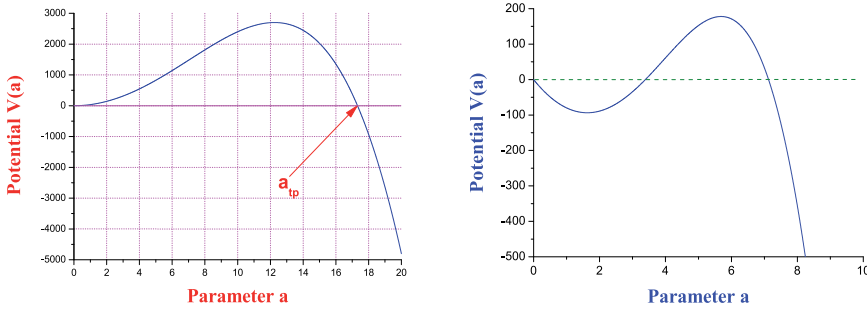

Fig. 7. Cosmological potentials with and without Chaplygin gas: Left panel is for potential $V(a) = 36 a^2 - 12 \Lambda a^4$ with parameter $\Lambda = 0.01$ (turning point $a_{tp} = 17.320508$ at zero energy $E_{\text{rad}} = 0$), Right panel is for potential (69) with parameters $\Lambda = 0.01, \rho_{\text{dust}} = 30, \alpha = 0.5$ (minimum of the hole is -93.579 and its coordinate is 1.6262 , maximum of the barrier is 177.99 and its coordinate is 5.6866).

Let us expand the potential (69) close to arbitrary selected point \bar{a} by powers of $q = a - \bar{a}$ and restrict ourselves to linear terms:

$$V_{\text{Ch}}(q) = V_0 + V_1 q. \tag{70}$$

For coefficients V_0 and V_1 we find:

$$\begin{aligned} V_0 &= V_{\text{Ch}}(a = \bar{a}), \\ V_1 &= \left. \frac{dV_{\text{Ch}}(a)}{da} \right|_{a=\bar{a}} = 72a + 12a^3 \left\{ -4\Lambda - \frac{\rho_{\text{dust}}}{a^3(1+\alpha)} \right\} \cdot \left(\Lambda + \frac{\rho_{\text{dust}}}{a^3(1+\alpha)} \right)^{-\alpha/(1+\alpha)} \end{aligned} \quad (71)$$

and eq. (67) has the form:

$$-\frac{d^2}{dq^2} \varphi(q) + (V_0 - E_{\text{rad}} + V_1 q) \varphi(q) = 0. \quad (72)$$

After the change of variable

$$\zeta = |V_1|^{1/3} q, \quad \frac{d^2}{dq^2} = \left(\frac{d\zeta}{dq} \right)^2 \frac{d^2}{d\zeta^2} = |V_1|^{2/3} \frac{d^2}{d\zeta^2} \quad (73)$$

eq. (72) becomes:

$$\frac{d^2}{d\zeta^2} \varphi(\zeta) + \left\{ \frac{E_{\text{rad}} - V_0}{|V_1|^{2/3}} - \frac{V_1}{|V_1|} \zeta \right\} \varphi(\zeta) = 0. \quad (74)$$

After the new change

$$\tilde{\zeta} = \frac{E_{\text{rad}} - V_0}{|V_1|^{2/3}} - \frac{V_1}{|V_1|} \zeta \quad (75)$$

we have

$$\frac{d^2}{d\tilde{\zeta}^2} \varphi(\tilde{\zeta}) + \tilde{\zeta} \varphi(\tilde{\zeta}) = 0. \quad (76)$$

From eqs. (73) and (75) we have:

$$\tilde{\zeta} = \frac{E_{\text{rad}} - V_0}{|V_1|^{2/3}} - \frac{V_1}{|V_1|^{2/3}} q. \quad (77)$$

Using such corrections after inclusion of the density component of the Chaplygin gas, we have calculated the wave function and on its basis the coefficients of penetrability, reflection and mixing by the formalism presented above. Now following the method of Sec. 3.1, we have defined the incident and reflected waves relatively to a new boundary which is located in the minimum of the hole in the internal region. Results are presented in Tabl. 3. One can see that penetrability changes up to 100 times, in such a coordinate, in dependence on the location of the boundary or in the internal turning point (for the same barrier shape and energy E_{rad})! This confirms that the coordinate where incident and reflected waves are defined has essential influence on estimation of the coefficients of penetrability and reflection. This result shows that the method proposed in the present paper has physical sense. In the next Tabl. 4, we demonstrate the fulfillment of the property (55) inside the entire energy range, which is calculated on the basis of the coefficients of penetrability, reflection and mixing obtained before.

5. Multiple internal reflections fully quantum method

5.1 Passage to non-stationary WDW equation: motivations

Tunneling is a pure quantum phenomenon characterized by the fact that a particle crosses through a classically-forbidden region of the barrier. By such a reason, the process of incidence of the particle on the barrier and its further tunneling and reflection are connected by unite

cause-effect relation. So, the dynamical consideration of the tunneling process through cosmological barriers is a natural one (Aharonov, 2002; Esposito, 2003; Jakiel et al., 1999; Olkhovsky & Recami, 1992; Olkhovsky et al., 1995; 2004; 2005; Olkhovsky & Recami, 2008; Olkhovsky, 2011; Recami, 2004). The rejection of the dynamical consideration of tunneling from quantum cosmology limits the possible connection between initial stage, when the wave is incident on the barrier, and next propagation of this wave. This leads to uncertainties in determination of penetrability and rates. According to quantum mechanics, a particle is a quantum object having properties both particle and wave. In the classically forbidden regions the wave properties of the studied object are evident. So, the wave description of tunneling is natural.

So, we define a non-stationary generalization of WDW equation as

$$\left(\frac{\partial^2}{\partial a^2} - V_{\text{eff}}(a)\right)\Psi(a, \tau) = -i \frac{\partial}{\partial \tau} \Psi(a, \tau), \quad (78)$$

where τ is a new variable describing dynamics of evolution of the wave function being analog of time. According to quantum mechanics, the penetrability and reflection are stationary characteristics, and such characteristics, obtained in the following, are independent on the parameter τ . Note that all these characteristics are solutions of stationary WDW equation, while non-stationary consideration of multiple packets moving along barrier gives clear understanding of the process.

In order to give a basis to readers to estimate ability of the approach developed in this paper, let us consider results in (Monerat et al., 2007) (see eq. (19)). Here was studied the non-stationary WDW equation

$$\left(\frac{1}{12} \frac{\partial^2}{\partial a^2} - V_{\text{eff}}(a)\right)\Psi(a, \tau) = -i \frac{\partial}{\partial \tau} \Psi(a, \tau) \quad (79)$$

with the potential for the closed FRW model with the included generalized Chaplygin gas.

$$V_{\text{eff}}(a) = 3a^2 - \frac{a^4}{\pi} \sqrt{\bar{A} + \frac{\bar{B}}{a^6}} \quad (80)$$

After change of variable $a_{\text{new}} = a_{\text{old}} \sqrt{12}$ the non-stationary eq. (79) transforms into our eq. (78) since the V_{eff} potential is independent on the τ variable (such a choice allows a correspondence between energy levels, convenient in comparative analysis). The potential (79) after such a transformation is shown in figs. 8. We shall analyze the behavior of the wave function.

5.2 Tunneling of the packet through a barrier composed from arbitrary number of rectangular steps

Now let us come to another more difficult problem, namely that a packet penetrating through the radial barrier of arbitrary shape in a cosmological problem. In order to apply the idea of multiple internal reflections for study the packet tunneling through the real barrier, we have to generalize the formalism of the multiple internal reflections presented above (Maydanyuk, 2011). We shall assume that the total potential has successfully been approximated by finite

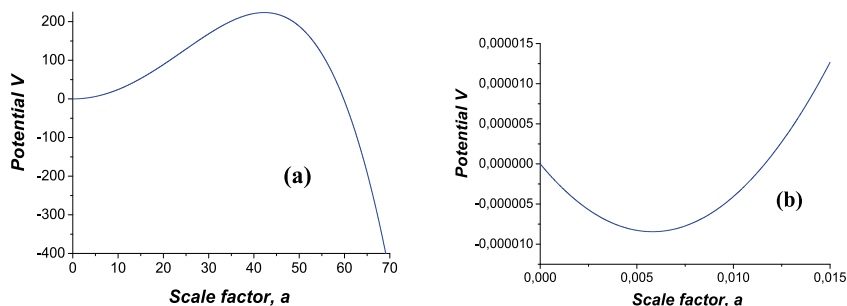

Fig. 8. Behavior of the potential (80) after change $a_{\text{new}} = a_{\text{old}} \sqrt{12}$ at $\bar{A} = 0.001$ and $\bar{B} = 0.001$ (choice of parameters see in fig. 1, tables I and II in (Monerat et al., 2007)): (a) shape of the barrier ($V_{\text{max}} = 223.52$ at $a = 42.322$); (b) there is a little internal well close to zero ($V_{\text{min}} = -8.44$ at $a = 0.00581$)

number N of rectangular steps:

$$V(a) = \begin{cases} V_1, & \text{at } a_{\text{min}} < a \leq a_1 & \text{(region 1),} \\ V_2, & \text{at } a_1 < a \leq a_2 & \text{(region 2),} \\ \dots & \dots & \dots \\ V_N, & \text{at } a_{N-1} < a \leq a_{\text{max}} & \text{(region N),} \end{cases} \quad (81)$$

where V_i are constants ($i = 1 \dots N$). Let us assume that the packet starts to propagate outside inside the region with some arbitrary number M (for simplicity, we denote its left boundary a_{M-1} as a_{start}) from the left of the barrier. We are interested in solutions for energies above that of the barrier while the solution for tunneling could be obtained after by change $i \zeta_i \rightarrow k_i$. A general solution of the wave function (up to its normalization) has the following form:

$$\varphi(a) = \begin{cases} \alpha_1 e^{ik_1 a} + \beta_1 e^{-ik_1 a}, & \text{at } a_{\text{min}} \leq a \leq a_1 & \text{(region 1),} \\ \dots & \dots \\ \alpha_{M-1} e^{ik_{M-1} a} + \beta_{M-1} e^{-ik_{M-1} a}, & \text{at } a_{M-2} \leq a \leq a_{M-1} & \text{(region } M-1), \\ e^{ik_M a} + A_R e^{-ik_M a}, & \text{at } a_{M-1} < a \leq a_M & \text{(region } M), \\ \alpha_{M+1} e^{ik_{M+1} a} + \beta_{M+1} e^{-ik_{M+1} a}, & \text{at } a_M \leq a \leq a_{M+1} & \text{(region } M+1), \\ \dots & \dots \\ \alpha_{n-1} e^{ik_{n-1} a} + \beta_{n-1} e^{-ik_{n-1} a}, & \text{at } a_{N-2} \leq a \leq a_{N-1} & \text{(region } N-1), \\ A_T e^{ik_N a}, & \text{at } a_{N-1} \leq a \leq a_{\text{max}} & \text{(region } N), \end{cases} \quad (82)$$

where α_j and β_j are unknown amplitudes, A_T and A_R are unknown amplitudes of transmission and reflection, $k_i = \frac{1}{\hbar} \sqrt{2m(E - V_i)}$ are complex wave numbers. We have fixed

the normalization so that the modulus of the starting wave $e^{ik_M a}$ equals to one. We look for a solution of such a problem by the approach of the multiple internal reflections.

Let us consider the initial stage when the packet starts to propagate to the right in the region with number M . According to the method of the multiple internal reflections, propagation of the packet through the barrier is considered by steps of its propagation relatively to each boundary (see (Cardone et al., 2006; Maydanyuk et al., 2002a; Maydanyuk, 2003; Maydanyuk & Belchikov, 2011), for details). Each next step in such a consideration of propagation of the packet will be similar to the first $2N - 1$ steps. From analysis of these steps recurrent relations are found for calculation of all unknown amplitudes $A_T^{(n)}$, $A_R^{(n)}$, $\alpha_j^{(n)}$ and $\beta_j^{(n)}$ for arbitrary step n (for region with number j), summation of these amplitudes are calculated. We shall look for the unknown amplitudes, requiring the wave function and its derivative to be continuous at each boundary. We shall consider the coefficients $T_1^\pm, T_2^\pm \dots$ and $R_1^\pm, R_2^\pm \dots$ as additional factors to amplitudes $e^{\pm ik a}$. Here, the bottom index denotes the number of the region, upper (top) signs “+” and “-” denote directions of the wave to the right or to the left, correspondingly. To begin with, we calculate $T_1^\pm, T_2^\pm \dots T_{N-1}^\pm$ and $R_1^\pm, R_2^\pm \dots R_{N-1}^\pm$:

$$\begin{aligned} T_j^+ &= \frac{2k_j}{k_j + k_{j+1}} e^{i(k_j - k_{j+1})a_j}, & T_j^- &= \frac{2k_{j+1}}{k_j + k_{j+1}} e^{i(k_j - k_{j+1})a_j}, \\ R_j^+ &= \frac{k_j - k_{j+1}}{k_j + k_{j+1}} e^{2ik_j a_j}, & R_j^- &= \frac{k_{j+1} - k_j}{k_j + k_{j+1}} e^{-2ik_{j+1} a_j}. \end{aligned} \quad (83)$$

Analyzing all possible “paths” of the propagations of all possible packets inside the barrier and internal well, we obtain (Maydanyuk, 2011):

$$\begin{aligned} \sum_{n=1}^{+\infty} A_{\text{inc}}^{(n)} &= 1 + \tilde{R}_M^+ \tilde{R}_{M-1}^- + \tilde{R}_M^+ \tilde{R}_{M-1}^- \cdot \tilde{R}_M^+ \tilde{R}_{M-1}^- + \dots = \\ &= 1 + \sum_{m=1}^{+\infty} (\tilde{R}_M^+ \tilde{R}_{M-1}^-)^m = \frac{1}{1 - \tilde{R}_M^+ \tilde{R}_{M-1}^-}, \\ \sum_{n=1}^{+\infty} A_T^{(n)} &= \left(\sum_{n=1}^{+\infty} A_{\text{inc}}^{(n)} \right) \cdot \left\{ \tilde{T}_{N-2}^+ T_{N-1}^+ + \right. \\ &\quad \left. + \tilde{T}_{N-2}^+ \cdot R_{N-1}^+ \tilde{R}_{N-2}^- \cdot T_{N-1}^+ + \dots \right\} = \\ &= \left(\sum_{n=1}^{+\infty} A_{\text{inc}}^{(n)} \right) \cdot \tilde{T}_{N-1}^+, \quad (84) \\ \sum_{n=1}^{+\infty} A_R^{(n)} &= \tilde{R}_M^+ + \tilde{R}_M^+ \cdot \tilde{R}_{M-1}^- \tilde{R}_M^+ + \\ &\quad + \tilde{R}_M^+ \cdot \tilde{R}_{M-1}^- \tilde{R}_M^+ \cdot \tilde{R}_{M-1}^- \tilde{R}_M^+ + \dots = \\ &= \tilde{R}_M^+ \cdot \left(1 + \sum_{m=1}^{+\infty} (\tilde{R}_{M-1}^- \tilde{R}_M^+)^m \right) = \\ &= \frac{\tilde{R}_M^+}{1 - \tilde{R}_{M-1}^- \tilde{R}_M^+} = \left(\sum_{n=1}^{+\infty} A_{\text{inc}}^{(n)} \right) \cdot \tilde{R}_M^+, \end{aligned}$$

where

$$\begin{aligned}
 \tilde{R}_{j-1}^+ &= R_{j-1}^+ + T_{j-1}^+ \tilde{R}_j^+ T_{j-1}^- \left(1 + \sum_{m=1}^{+\infty} (\tilde{R}_j^+ R_{j-1}^-)^m \right) = \\
 &= R_{j-1}^+ + \frac{T_{j-1}^+ \tilde{R}_j^+ T_{j-1}^-}{1 - \tilde{R}_j^+ R_{j-1}^-}, \\
 \tilde{R}_{j+1}^- &= R_{j+1}^- + T_{j+1}^- \tilde{R}_j^- T_{j+1}^+ \left(1 + \sum_{m=1}^{+\infty} (R_{j+1}^+ \tilde{R}_j^-)^m \right) = \\
 &= R_{j+1}^- + \frac{T_{j+1}^- \tilde{R}_j^- T_{j+1}^+}{1 - R_{j+1}^+ \tilde{R}_j^-}, \\
 \tilde{T}_{j+1}^+ &= \tilde{T}_j^+ T_{j+1}^+ \left(1 + \sum_{m=1}^{+\infty} (R_{j+1}^+ \tilde{R}_j^-)^m \right) = \frac{\tilde{T}_j^+ T_{j+1}^+}{1 - R_{j+1}^+ \tilde{R}_j^-}.
 \end{aligned}
 \tag{85}$$

Choosing as starting points, the following:

$$\begin{aligned}
 \tilde{R}_{N-1}^+ &= R_{N-1}^+, \\
 \tilde{R}_M^- &= R_M^-, \\
 \tilde{T}_M^+ &= T_M^+,
 \end{aligned}
 \tag{86}$$

we calculate the coefficients $\tilde{R}_{N-2}^+ \dots \tilde{R}_M^+, \tilde{R}_{M+1}^- \dots \tilde{R}_{N-1}^-$ and $\tilde{T}_{M+1}^+ \dots \tilde{T}_{N-1}^+$. We shall consider propagation of all packets in the region with number M , to the left. Such packets are formed in result of all packets reflections from the right part of potential, starting from the boundary a_M . In the previous section to describe their reflection from the left boundary R_0 to the right one, we used coefficient R_0^- . Now since we want to pass from simple boundary a_{M-1} to the left part of the potential well starting from this point up to a_{\min} , we generalize the coefficient R_{M-1}^- to \tilde{R}_{M-1}^- . The middle formula in (85) is applicable when we use eqs. (83) for definition of T_i^\pm and R_i^\pm . Finally, we determine coefficients α_j and β_j :

$$\begin{aligned}
 \sum_{n=1}^{+\infty} \alpha_j^{(n)} &= \tilde{T}_{j-1}^+ \left(1 + \sum_{m=1}^{+\infty} (R_j^+ \tilde{R}_{j-1}^-)^m \right) = \\
 &= \frac{\tilde{T}_{j-1}^+}{1 - R_j^+ \tilde{R}_{j-1}^-} = \frac{\tilde{T}_j^+}{T_j^+}, \\
 \sum_{n=1}^{+\infty} \beta_j^{(n)} &= \tilde{T}_{j-1}^+ \left(1 + \sum_{m=1}^{+\infty} (\tilde{R}_j^+ \tilde{R}_{j-1}^-)^m \right) R_j^+ = \\
 &= \frac{\tilde{T}_{j-1}^+ R_j^+}{1 - \tilde{R}_j^+ \tilde{R}_{j-1}^-} = \frac{\tilde{T}_j^+ R_j^+}{T_j^+},
 \end{aligned}
 \tag{87}$$

the amplitudes of transmission and reflection:

$$\begin{aligned}
 A_T &= \sum_{n=1}^{+\infty} A_T^{(n)}, \quad A_R = \sum_{n=1}^{+\infty} A_R^{(n)}, \\
 \alpha_j &= \sum_{n=1}^{+\infty} \alpha_j^{(n)} = \frac{\tilde{T}_j^+}{T_j^+}, \quad \beta_j = \sum_{n=1}^{+\infty} \beta_j^{(n)} = \alpha_j \cdot R_j^+
 \end{aligned}
 \tag{88}$$

and coefficients T and R describing penetration of the packet from the internal region outside and its reflection from the barrier

$$\begin{aligned} T_{MIR} &\equiv \frac{k_N}{k_M} |A_T|^2 = |A_{\text{inc}}|^2 \cdot T_{\text{bar}}, & T_{\text{bar}} &= \frac{k_N}{k_M} |\tilde{T}_{N-1}^+|^2, \\ R_{MIR} &\equiv |A_R|^2 = |A_{\text{inc}}|^2 \cdot R_{\text{bar}}, & R_{\text{bar}} &= |\tilde{R}_M^+|^2. \end{aligned} \quad (89)$$

Choosing $a_{\text{min}} = 0$, we assume full propagation of the packet through such a boundary (with no possible reflection) and we have $R_0^- = -1$ (it could be interesting to analyze results with varying R_0^-). We use the test:

$$\frac{k_N}{k_M} |A_T|^2 + |A_R|^2 = 1 \quad \text{or} \quad T_{MIR} + R_{MIR} = 1. \quad (90)$$

Now if energy of the packet is located below then height of one step with number m , then the following change

$$k_m \rightarrow i \tilde{\zeta}_m \quad (91)$$

should be used to describe the transition of this packet through such a barrier with its tunneling. In the case of a barrier consisting from two rectangular steps of arbitrary heights and widths we have already obtained coincidence between amplitudes calculated by method of MIR and the corresponding amplitudes found by standard approach of quantum mechanics up to first 15 digits. Even increasing the number of steps up to some thousands has the right accuracy to fulfill the property (90).

In particular, we reconstruct completely the pictures of the probability and reflection presented in figs. 9 (a) and (b), figs. 10 (a) and (b), figs. 11 (b), but using such a standard technique. So, the *result concerning the oscillating dependence of the penetrability on the position of the starting point a_{start} in such figures is independent on the fully quantum method chosen for calculations.*

This is an important test which confirms reliability of the method MIR. So, we have obtained full coincidence between all amplitudes, calculated by method MIR and by standard approach of quantum mechanics. This is why we generalize the method MIR for description of tunneling of the packet through potential, consisting from arbitrary number of rectangular barriers and wells of arbitrary sizes (Maydanyuk, 2011).

5.3 Results

We have applied the above method to analyze the behavior of the packet tunneling through the barrier (80) (we used $a_{\text{new}} \rightarrow \sqrt{12} a_{\text{old}}$). The first interesting result is *a visible change of the penetrability on the displacement of the starting point $a_{\text{min}} \leq a \leq a_1$, where we put the packet.* Using the possibility of decreasing the width of intervals up to an enough small value (and choosing, for convenience, the width of each interval to be the same), we choose a_{min} as *starting point* (and denote it as a_{start}), from where the packet begins to propagate outside. We have analyzed how the position of such a point influences the penetrability. In fig. 9 (a) one can see that the penetrability strongly changes in dependence of a_{start} for arbitrary values of energy of radiation E_{rad} : it has oscillating behavior (Maydanyuk, 2011). Difference between its minimums and maximums is minimal at a_{start} in the center of the well (i. e. its change tends to zero in the center of the well), this difference increases with increasing value of a_{start} and achieves the maximum close to the turning point. With this result, we may conclude that *exists a dependence of penetrability on the starting point a_{start} of the packet.* The coefficients of

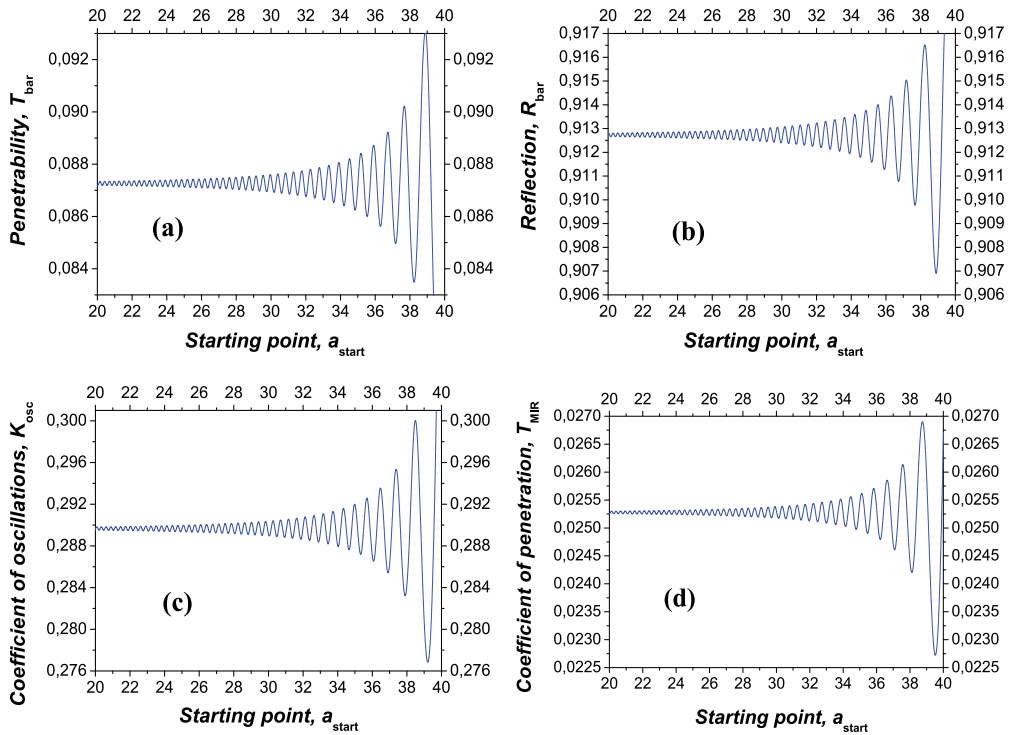

Fig. 9. Dependencies of the coefficients of the penetrability T_{bar} (a), reflection R_{bar} (b), coefficient of oscillations K_{osc} (c) and coefficient of penetration T_{MIR} (d) in terms of the position of the starting point a_{start} for the energy $E = 220$ ($A = 0.001$, $B = 0.001$, $a_{\text{max}} = 70$). The total number of intervals is 2000, for all presented cases the achieved accuracy is $|T_{\text{bar}} + R_{\text{bar}} - 1| < 10^{-15}$. These figures clearly demonstrate oscillating (*i.e.* not constant) behavior of all considered coefficients on a_{start} .

reflection, oscillations and penetration on the position of the starting point a_{start} are presented in next figs. 9 (b), (c), (d) and have similar behavior.

Usually, in cosmological quantum models the penetrability is determined by the barrier shape. In the non-stationary approach one can find papers where the role of the initial condition is analyzed in calculations of rates, penetrability etc.³ But, the stationary limit does not give us any choice on which to work. We conclude: (a) the penetrability should be connected with the initial condition (not only in non-stationary consideration, but also in the stationary one). (b) Even in the stationary consideration, the penetrability of the barrier should be determined in dependence on the initial condition.

The first question is how much these results are reliable. In particular, how stable will such results be if we shift the external boundary outside? The results of such calculations are presented in fig. 10, where it is shown how the penetrability changes with a_{max} (for clearness sake, we have fixed the starting point $a_{\text{start}} = 10$, (Maydanyuk, 2011)). One can see that

³ Such papers are very rare and questions about dynamics have not been studied deeply.

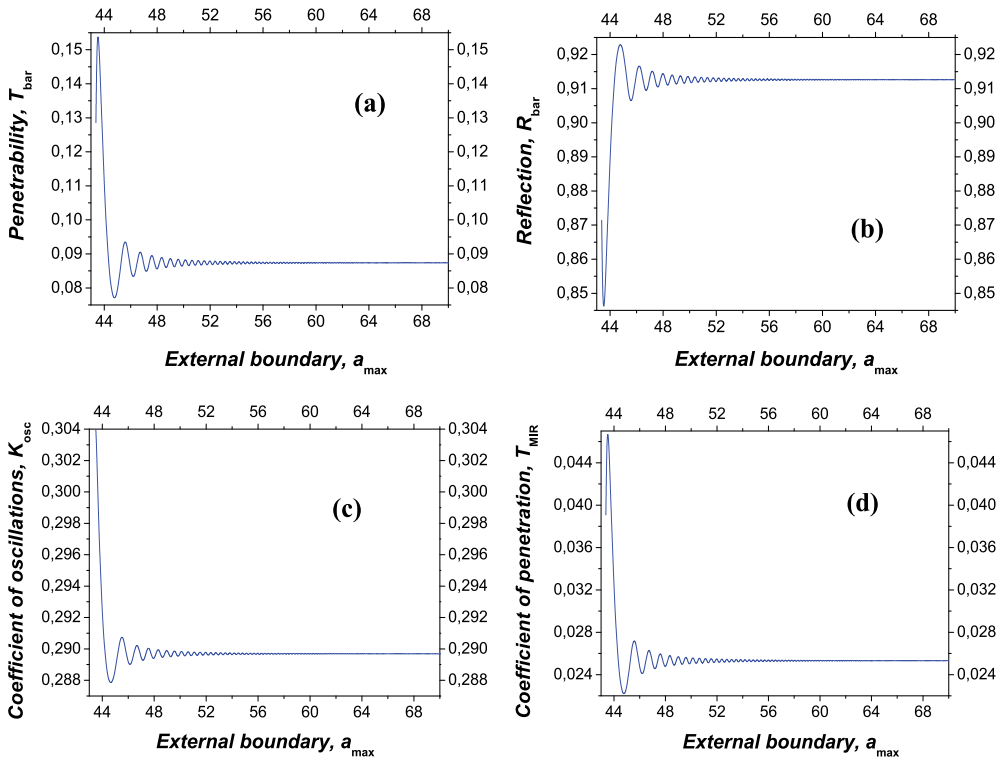

Fig. 10. Dependencies of the coefficients of penetrability (a), reflection (b), oscillations (c) and penetration (d) on the position of the external region, a_{\max} for the energy $E = 223$ ($A = 0.001, B = 0.001$). For all presented values we have achieved accuracy $|T_{\text{bar}} + R_{\text{bar}} - 1| < 1 \cdot 10^{-15}$ (the maximum number of intervals is 2000).

all calculations are well convergent, that confirms efficiency of the method of the multiple internal reflections. On the basis of such results we choose $a_{\max} = 70$ for further calculations. However, one can see that inclusion of the external region can change the coefficients of penetrability and penetration up to 2 times for the chosen energy level.

The second question is how strong this affects the calculations of the penetrability. If it was small than, the semiclassical approaches would have enough good approximation. From figs. 9 it follows that the penetrability is not strongly changed in dependence on shift of the starting point. However, such small variations are connected with relatively small height of the barrier and depth of the well, while they would be not small for another choice of parameters (the coefficient of oscillation and penetration turn out to change at some definite energies of radiation, see below). So, this effect is supposed to be larger at increasing height of the barrier and depth of the well, and also for near-barrier energies (i. e. for energies comparable with the barrier height, and above-barrier energies of radiation).

We have analyzed how these characteristics change in dependence on the energy of radiation. We did not expect the results that we got (see figs. 11). The coefficient of penetration has oscillations with peaks clearly shown (Maydanyuk, 2011). These peaks are separated by

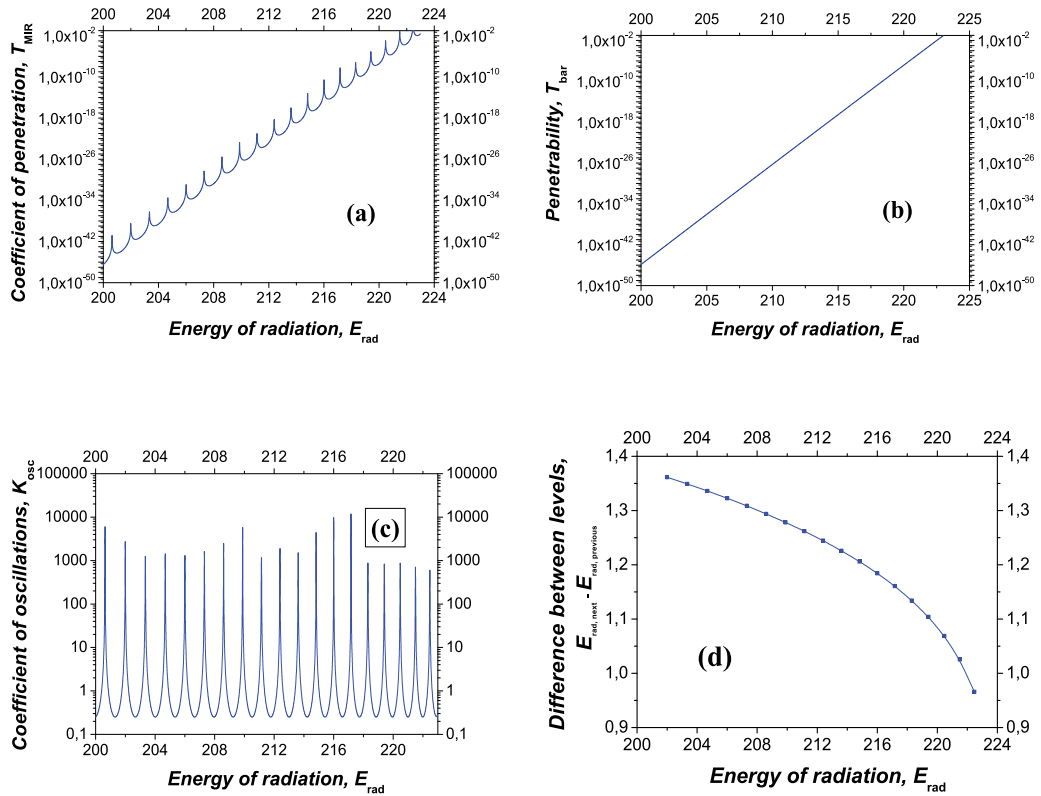

Fig. 11. Dependencies of the coefficient of the coefficient of penetration T_{MIR} (a), the coefficient of the penetrability T_{bar} (b), coefficient of oscillations K_{osc} (c) and difference $E_{\text{res,next}} - E_{\text{res,previous}}$ between two closest energy peaks (d) on the E_{rad} energy (we have choose: $A = 0.001$ and $B = 0.001$, $a_{\text{start}} = 10$, $a_{\text{max}} = 70$, number of intervals inside the scale axis a 1000, number of intervals of energy 100000). Inside the energy region $E_{\text{rad}} = 200 - 223$ we observe 19 resonant peaks in the dependencies of coefficients T_{MIR} and K_{osc} while the penetrability increases monotonously with increasing the E_{rad} energy.

similar distances and could be considered as resonances in energy scale. So, by using the fully quantum approach we observed for the first time clear pictures of resonances which could be connected with some early unknown quasi-stationary states. At increasing energy of radiation the penetrability changes monotonously and determines a general tendency of change of the coefficient of penetration, while the coefficient of oscillations introduces the peaks. Now the reason of the presence of resonances has become clearer: oscillations of the packet inside the internal well produce them, while the possibility of the packet to penetrate through the barrier (described by the penetrability of the barrier) has no influence on them. In general, we observe 134 resonant levels inside energy range $E_{\text{rad}} = 0-200$, and else 19 levels inside $E_{\text{rad}} = 200-223$.

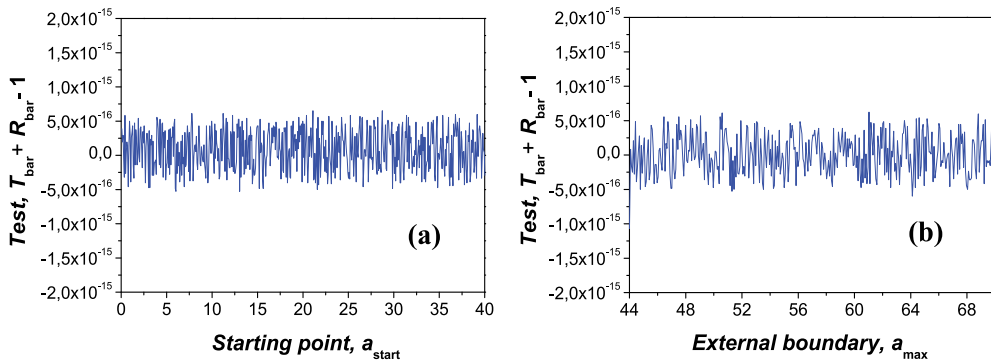

Fig. 12. Accuracy of the obtained penetrability T_{bar} and reflection R_{bar} for the energy $E = 220$ used in previous figs. 9 and 10. As a test, we calculate $T_{\text{bar}} + R_{\text{bar}} - 1$ in dependence on the position of the starting point a_{start} (a) and the external boundary a_{max} (b) ($A = 0.001, B = 0.001$, total number of intervals is 2000).

In the last fig. 12 one can see that we have achieved $|T_{\text{bar}} + R_{\text{bar}} - 1| < 10^{-15}$ inside whole region of changes of a_{start} and a_{max} (such data were used in the previous figs. 9 and 10). This is the accuracy of the method of the multiple internal reflections in obtaining T_{bar} and R_{bar} .

5.4 The fully quantum penetrability versus semiclassical one in cosmology: a quick comparison

Does the penetrability, determined according to the semiclassical theory by a shape of the barrier between two turning points, give exhaustive answers and the best estimations of rates of evolution of universe? If we look at figs. 9 (a), we shall see that this is not the case. The penetrability is depended on the position (coordinate) of maximum of the packet which begins to propagate outside at time moment $t = 0$. So, the penetrability should be a function of some parameters of the packet at beginning. For the first time, it has been demonstrated the difference between the fully quantum approach and the semiclassical one. However, let us perform a general analysis (Maydanyuk, 2011).

(1) If we wanted to check the semiclassical approach, we should miss some of the parameters. One can use test of $T + R = 1$ (where T and R are the penetrability through the barrier and reflection from it). But, note that the semiclassical approximation neglects the reflected waves in quantum mechanics (see (Landau & Lifshitz, 1989), eq. (46.10), p. 205, p. 221–222). Therefore, we cannot use the test above for checking T in the semiclassical theory.

(2) If we would like to determine the reflection coefficient, then we should find a more accurate semiclassical approximation (in order to take into account both decreasing and increasing components of the wave function in the tunneling region). In such a case, we shall face another problem, namely the presence of a non-zero interference between the incident and reflected waves. Now the relation $T + R = 1$ cannot be used as test, and one needs to take the third component M of interference into account (see (Maydanyuk, 2010)). If we improperly separate the exactly known full wave function in the incident and reflected waves⁴, the interference component should increase without limit. In such a case, the penetrability and reflection

⁴ However, the semiclassical approaches have no apparatus for such an analysis.

can freely exceed unit and increase without limit. What is now the general meaning of the penetrability?

(3) We shall give only some examples from quantum mechanics. (i) If we consider two-dimensional penetration of the packet through the simplest rectangle barrier (with finite size), we shall see that the penetrability is directly dependent on direction of tunneling of the packet. So, the penetrability is not a single value but a function. (ii) If we consider one-dimensional tunneling of the packet through the simplest rectangular barrier, we shall obtain “interference picture” of its amplitude in the transmitted region, which is dependent on time and space coordinates and is an exact analytical solution. Of course, the stationary part of such a result exactly coincides with well known stationary solutions (Maydanyuk, 2003).

(4) A tunneling boundary condition (Vilenkin, 1994) seems to be natural and clear, where the wave function should represent an outgoing wave at large scale factor a . However, is such a wave free? In contrast to problems of quantum atomic and nuclear physics, in cosmology we deal with potentials, which modules increase with increasing the scale factor a (their gradients increase, which have sense of force acting on the wave). Therefore, in quantum cosmology we should define the boundary condition on the basis of the waves propagating inside strong fields (see (Maydanyuk, 2010)).

These points destroy the semiclassical basis of the cosmological models. Now the statement concerning reliability of the semiclassical approach become a question of “faith” (note that this is widespread (Maydanyuk, 2010; 2011)). The semiclassical approach could be compared with “black box”, where deeper and more detailed information about the dynamics of the universe is hidden.

6. A brief review on the problems of the Universe origin

In the science history and in the science philosophy of XX-XXI cc. (especially in the field of the natural sciences, beginning from physics) there has been a lot of interesting things, which had not obtained a sufficiently complete elucidation and analysis yet. Firstly, under the influence of scientific and technological progress a great attention has been paid to the justification of such direction in the science philosophy as the scientific realism (i.e. the correspondence of the science to the reality), which has successively acquired three forms: the naive realism, the usual realism and the critical science realism. Secondly, some new important problems of physics (especially the problem of the essentially probabilistic description of the reality of the microscopic world, the problem of the essential influence of the observer on the reality, the collapse of the wave function) had been revealed in the development of quantum mechanics, *the continuously complicated interpretation of the Universe origin and the expansion after the Big Bang*, and also no succeeded attempt in explaining the origin of the biological life in terms of physics and other natural sciences, all being with a variety of interpretation versions, connected with the world-views of the researchers.

As to “great” and “grand” problems of natural sciences: There is an extensive introduction in the large number of open problems in many fields of physics, published by the Russian physicist V. Ginzburg in (Ginzburg, 1999) which is rather interesting to study. Inside this large list of open problems of modern physics (and in a certain degree of modern natural sciences), represented by V. Ginzburg repeatedly in Russian editions, some of them are marked him “great” or “grand” problems. Between namely these problems we would like to underline three of them.

a) *The problem of interpretation and comprehension of quantum mechanics (even of the non-relativistic quantum theory) remains still topical.* The majority of critics of quantum mechanics are unsatisfied with the probabilistic nature of its predictions. One can add here also the questions and paradoxes of the theory of quantum measurements theory, especially like the wave-function reduction. The appearance of quantum mechanics, and, in particular, the discussion of N. Bohr with A. Einstein (lasting many years), had seriously undermined the traditional forms of the naive realism in the philosophy of the scientific realism and had strongly influenced (and are continuing to influence) not only on physics but also on other kinds of knowledge in the sense of the dependence of the reality on the observer and, moreover, on our understanding of the human knowledge at all. More lately the new interpretation of quantum mechanics is appeared: in it the hypothesis of many universes, which are the exactly same as ours, permits to avoid the wave-function reduction.

b) *The relationship between physics and biology and, specifically, the problem of reductionism.* The main problem, according to V. Ginzburg, is connected with the explanation of the origin of the biologic life and the origin of the human abstract thinking (but the second one is connected not with biology but with the origin of the human spiritual life which is far beyond natural sciences). V. Ginzburg assumes that for a possible explanation of the origin of the biologic life one can naturally imagine a certain jump which is similar to some kind of phase transition (or, may be, certain synergetic process). But there are other points of view too.

c) *The cosmological problem* (in other words, *the problem of the Universe origin*). According to V. Ginzburg, it is also a grand problem, or strictly speaking, a great complex of cosmic problems many of which is far from the solution.

We did also analyzed in (Olkhovsky, 2010) these three problems in the context of other aspects, first of all regarding the increasing discussions between the supporters of two different meta-theoretical, meta-philosophical doctrines: either the beginning of the Universe formation from vacuum (“nothing”) is either a result of the irrational randomness after passing from other space-time dimensions or from other universe, caused by some unknown process, or a result of the creation of the expanding Universe (together with the laws of its functioning) by the supreme intelligent design from *nigilo*.

6.1 Schematic description of the problems connected with the Universe origin and expansion

Earlier, after Enlightenment till approximately 1920, scientists in the natural sciences did usually consider the Universe as eternally existing and eternally moving. Now the most convincing arguments against the model of the eternally existing Universe are:

- (a) the second law of thermodynamics which does inevitably bring to heat death of Universe,
- (b) the observed cosmic microwave background.

The most surprising conclusion of the revealed non-stationary state of the Universe is the existence of the “beginning”, under which the majority of physicists understand the beginning of the Universe expansion.

The cosmologic problem as the problem of the origin and evolution of the Universe has initiated to be analyzed by A. Einstein (after 1917) and now it is connected with papers of many other physicists. The first several authors had been G. Lemaitre (who proposed what became known as the Big Bang theory of the origin of the Universe, although he called it his “hypothesis of the primeval atom”), A. Friedman and G. Gamow.

And what namely had been in the “beginning”? Gamow had assumed in 1921 that the expansion had initiated from the super-condensed hot state as a result of the Big Bang,

to which he and others had ascribed the time moment $t = 0$, i.e. the beginning of the Universe history. The initial state in this model is in fact postulated. The nature of the initial super-condensed hot Universe state is not known. Such initial point (or super-small region), in which the temperature, pressure, energy density etc had reached the anomalous huge (almost infinite) values, can be considered as a particular point, where the “physical” processes cannot be described by physical equations and in fact are excluded from the model analysis. Under these conditions the theory of grand unification (or superunification) of all four known interactions (strong, weak, electromagnetic and gravitational) is assumed to act. But no satisfactory superunification has yet been constructed. The superstring theory claims the role of such superunification, but this goal has not yet been achieved (Ginzburg, 1999). Strictly speaking, namely in the region of this point (from $t = 0$ till $t_0 = 10^{-44}$ sec., where t_0 is the Planck time) is arising the general problem of the world origin and also the choice dilemma: the beginning of the Universe formation from vacuum (“nothing”) is either a result of the irrational randomness after passing from other space-time dimensions or from other universe, caused by some unknown process, or a result of the creation of the expanding Universe (together with the laws of its functioning) by the supreme intelligent design from nighilo.

The framework for the standard cosmologic model relies on Einstein’s general relativity and on simplifying assumptions (such as homogeneity and isotropy of space). There are even non-standard alternative models. Now there are many supporters of Big Bang models. The number of papers and books on standard versions of the cosmologic Big Bang models is too enormous for citing in this short paper (it is possible to indicate, only for instance, (Hartle & Hawking, 1983; Kragh, 1996; Peacock, 1999; Vilenkin, 1994) for the initial reading in cosmology of the Universe and in the different quasi-classical and quantum approaches in cosmology for description of the creation and the initial expansion of the Universe). However, there is no well-supported model describing the Universe history prior to 10^{-15} sec. or so. Apparently a new unified theory of quantum gravitation is needed to break this barrier but the theory of quantum gravitation is only schematically constructed in the quasilinear approximation. Understanding this earliest era in the history of the Universe is currently one of the most important unsolved problems in physics. Further, over the time interval 10^{-35} sec., which is much larger than the Planck time and so can still be considered classically, the Universe was expanding (inflating) much more rapidly than in the known Friedman models. After the inflation, the Universe had been as though developing in accord with the Friedman’s scenario (Ginzburg, 1999). It may be possible to deduce what happened before inflation through observational tests yet to be discovered, and a crucial role at the inflation stage could be played the so-called Λ -term added to the Einstein equations of the General Relativity.

A lot of observations testify that there is exists non-luminous matter in the Universe which manifests itself owing to its gravitational interaction and is present everywhere — both in the galaxies and in the intergalactic space. And what is the nature of dark mass? According to the very popular hypothesis, the role of dark matter is played by the hypothetical WIMPs (Weakly Interacting Massive Particles) with masses higher than protons (Ginzburg, 1999). There are also exist some other candidates for the role of dark matter (for instance, pseudoscalar particles — axions) (Ellis, 1998). Cosmic strings can be also mentioned (Ginzburg, 1999).

The possibility of the existence of the above-mentioned Λ -term in equations of the General Relativity is now frequently referred to as “dark energy” or quintessence. For $\Lambda > 0$ it “works” as “antigravity” (against the normal gravitational attraction) and testifies to the

acceleration of the Universe expansion in our epoch (Armendariz-Picon et al., 2000; Ginzburg, 1999).

Moreover, it is worth to underline that many physicists consider that the second law of thermodynamics is universal for all closed systems, including also our Universe as a whole (which is closed in naturalistic one-world view). Therefore the heat death is inevitable (see, for instance, (Ginzburg, 1999) and especially (Adams & Laughlin, 1997)).

There are also versions of the non-standard versions of the cosmologic Big Bang models (Albrecht & Magueijo, 1999; Moffat, 1993; Petit, 1988; Petit & Vitor, 1989; Setterfield & Norman, 1987; Troitskii, 1987). We shall shortly refer to these models, noting that at least one of them (by B. Setterfield and T. Norman (Setterfield & Norman, 1987)) clearly speaks on the young Universe: They indicate that after the Big Bang the light speed had been gradually decreased approximately $10^6 - 10^7$ times and it was deduced that the velocities of the electromagnetic and radioactive decays had been gradually decreased near 10^7 times too. In (Setterfield & Norman, 1987; Troitskii, 1987) it was deduced that after the inflation the Universe had not been really expanding.

6.2 On the anthropic principle

From 1973 (and particularly after eighties) the term "*anthropic principle*", introduced by B. Carter, has become to acquire in the science and out of the science a certain popularity (Barrow & Tipler, 1986; Carter, 1974). Carter and other authors had been noted that physical constants must have values in the very narrow interval in order the existence of the biologic life can become possible, and that the measured values of these constants are really found in this interval. In other words, the Universe seems to be exactly such as it is necessary for the origin of the life. If physical constants would be even slightly other, then the life could be impossible. After meeting such testimonies, a number of scientists had formulated several interpretations of anthropic principle each of which brings the researchers to the worldview choice in its peculiar way. We shall consider here two of them. According to the *weak anthropic principle (WAP)*, the observed values of physical and cosmological constants caused by the necessary demand that the regions, where the organic life would be developed, ought to be possible. And in the context of WAP there is the possibility of choice between two alternatives:

1. Either someone does irrationally believe that there are possible an infinity of universes, in the past, in the present and in the future, and we exist and are sure in the existence of our Universe namely because the unique combination of its parameters and properties could permit our origin and existence.
2. Or someone does (also irrationally) believe that our unique Universe is created by Intelligent Design of a Creator (God) and the human being is also created by Creator in order to govern the Universe.

According to the *strong anthropic principle (SAP)*, the Universe has to have such properties which permit earlier or later the development of life. This form of the anthropic principle does not only state that the universe properties are limited by the narrow set of values, compatible with the development of the human life, but does also state that this limitation is necessary for such purpose. So, one can interpret such tuning of the universe parameters as the testimony of the supreme intelligent design of a certain creative basis. There is also a rather unexpected interpretation of SAP, connected with the eastern philosophy, but it is not widely known.

7. Conclusions and perspectives

In this Chapter the closed Friedmann–Robertson–Walker model with quantization in the presence of a positive cosmological constant and radiation was studied. We have solved it numerically and have determined the tunneling probability for the birth of an asymptotically de-Sitter, inflationary Universe as a function of the radiation energy. Note the following.

1. A fully quantum definition of the wave which propagates inside strong field and which interact minimally with them, has been formulated for the first time, and approach for its determination has been constructed.
2. A new stationary approach for the determination of the incident, reflected and transmitted waves relatively to the barrier has been constructed. The tunneling boundary condition has been corrected.
3. A quantum stationary method of determination of coefficients of penetrability and reflection relatively to the barrier with analysis of uniqueness of solution has been developed, where for the first time non-zero interference between the incident and reflected waves has been taken into account and for its estimation the coefficient of mixing has been introduced.
4. In this chapter a development of the method of multiple internal reflections is presented (see Refs. (Cardone et al., 2006; Maydanyuk et al., 2002a;b; Maydanyuk, 2003; Olkhovskiy & Maydanyuk, 2000), also Refs. (Anderson, 1989; Fermor, 1966; McVoy et al., 1967)). When the barrier is composed from arbitrary number n of rectangular potential steps, the exact analytical solutions for amplitudes of the wave function, the penetrability T_{bar} through the barrier and the reflection R_{bar} from it are found. At $n \rightarrow \infty$ these solutions can be considered as exact limits for potential with the barrier and well of arbitrary shapes.

In such a quantum approach the penetrability of the barrier for the studied quantum cosmological model with parameters $A = 36$, $B = 12 \Lambda$ ($\Lambda = 0.01$) has been estimated with a comparison with results of other known methods. Note the following.

1. The modulus of the coefficient of mixing is less 10^{-19} . This points out that *there is no interference between the found incident and reflected waves close to the internal turning point.*
2. On the basis of the calculated coefficients we reconstruct a property (55) inside the whole studied range of energy of radiation (see Fig. 12).
3. The probability of penetration of the packet from the internal well outside with its tunneling through the barrier of arbitrary shape is determined. We call such coefficient as *coefficient of penetration. This coefficient is separated on the penetrability and a new coefficient, which characterizes oscillating behavior of the packet inside the internal well and is called coefficient of oscillation. The formula found, seems to be the fully quantum analogue of the semiclassical formula of Γ width of decay in quasistationary state proposed in Ref. (Gurvitz & Kälbermann, 1987).* Here, the coefficient of oscillations is the fully quantum analogue for the semiclassical F factor of formation and the coefficient of penetration is analogue for the semiclassical Γ width.
4. The penetrability of the barrier visibly changes in dependence of the position of the starting point R_{start} inside the internal well, where the packet begins to propagate (see figs. 9). We note the following peculiarities: the penetrability has oscillating behavior, difference between its minimums and maximums is minimal at R_{start} in the center of the well, with increasing R_{start} this difference increases achieving to maximum near the turning

- point. The coefficients of reflection, oscillations and penetration have similar behavior. We achieve coincidence (up to the first 15 digits) between the amplitudes of the wave function obtained by such a method, and the corresponding amplitudes obtained by the standard approach of quantum mechanics (see Appendix B in (Maydanyuk & Belchikov, 2011) where solutions for amplitudes were calculated in general quantum decay problem). This confirms that this result does not depend on a choice of the fully quantum method applied for calculations. Such a peculiarity is shown in the fully quantum considerations and it is hidden after imposing the semiclassical restrictions.
5. The coefficient of penetration has oscillating dependence on the energy of radiation. Here, peaks are clearly shown. They are localized at similar distances (see figs. 11). So, for the first time we have obtained in the fully quantum approach a clear and stable picture of resonances, which indicate the presence of some early unknown quasistationary states. If the energy of radiation increases, the penetrability is monotonously changed. It describes a general tendency of behavior of the coefficient of penetration, while the coefficient of oscillations gives peaks. Now the reason of existence of resonances becomes clear: oscillations of the packet inside the internal well give rise to them. In particular, we establish 134 such resonant levels inside range $E_{\text{rad}} = 0-223$ for the barrier (8) with parameters $A = 0.001$ and $B = 0.001$.
 6. A dependence of the penetrability on the starting point has maxima and minima. This allows to predict some definite initial values of the scale factor, when the universe begins to expand. Such initial data is direct result of quantization of the cosmological model.
 7. The modulus of the wave function in the internal and external regions has minima and maxima which were clearly established in (Maydanyuk, 2008; 2010). This indicates, in terms of values of the scale factor, where the probable "appearance" of the universe is maximal or minimal. So, the radius of the universe during its expansion changes not continuously, but consequently passes through definite discrete values connected with these maxima. It follows that space-time of universe on the first stage after quantization seems to be rather discrete than continuous. According to results (Maydanyuk, 2008; 2010; 2011), difference between maxima and minima is slowly smoothed with increasing of the scale factor a . In this way, we obtain the continuous structure of the space-time at latter times. The discontinuity of space-time is direct result of quantization of cosmological model. This new phenomenon is the most strongly shown on the first stage of expansion and disappears after imposition of the semiclassical approximations.

8. Acknowledgments

One of us [ER] acknowledges partial support by INFN, and a fellowship by CAPES.

9. References

- Spravochnik po spetsialnim funktsiyam s formulami, grafikami we matematicheskimi tablitsami*, Pod redaktsiei Abramowitza M. we Stegan I. A. (Nauka, Moskva, 1979), 832 p.. — [in Russian; eng. variant: *Handbook of mathematical functions with formulas, graphs and mathematical tables*, Edited by Abramowitz M. and Stegan I. A., National bureau of standards, Applied math. series – 55, 1964].
- Acacio de Barros, J., Correa Silva, E. V., Monerat, G. A., Oliveira-Neto, G., Ferreira Filho, L. G. & Romildo Jr., P. (2007). Tunneling probability for the birth of an asymptotically de Sitter universe, *Phys. Rev.* Vol. D75: 104004. URL: gr-qc/0612031.

- Adams, F. C. & Laughlin, G. (1997). A Dying Universe: the Long-Term Fate and Evolution of Astrophysical Objects, *Rev. Mod. Phys.* Vol. 69: 337–372.
- Aharonov, Y., Erez, N. & Resnik, B. (2002). Superoscillations and tunneling times, *Phys. Rev.* Vol. A65: 052124.
- Albrecht, A. & Magueijo, J. (1999). A time varying speed of light as a solution to cosmological puzzles, *Phys. Rev.* Vol. D59: 043516. URL: astro-ph/9811018.
- Anderson, A. (1989). Multiple scattering approach to one-dimensional potential problems, *Am. Journ. Phys.* Vol. 57 (No. 3): 230–235.
- Armendariz-Picon, C., Mukhanov, V. & Steinhardt, P. J. (2000). Dynamical solution to the problem of a small cosmological constant and late-time cosmic acceleration, *Phys. Rev. Lett.* Vol. 85: 4438.
- Atkatz, D. & Pagels, H. (1982). Origin of the Universe as a quantum tunneling effect, *Phys. Rev.* Vol. D 25 (No. 8): 2065–2073.
- Barrow, J. D. & Tipler, F. J. (1986). *The Anthropic Cosmological Principle*, Clarendon Press, Oxford, 1986.
- Bento, M. C., Bertolami, O. & Sen, A. A. (2002). *Phys. Rev.* Vol. D 66: 043507. URL: gr-qc/0202064.
- Bilic, N., Tupper, G. B. & Viollier, R. D. (2002). *Phys. Lett.* Vol. B535: 17. URL: astro-ph/0111325.
- Bouhmadi-Lopez, M. & Moniz, P. V. (2005). FRW quantum cosmology with a generalized Chaplygin gas, *Phys. Rev.* Vol. D71 (No. 6): 063521 [16 pages]. URL: gr-qc/0404111.
- Bouhmadi-López, M., González-Díaz, P. F. & Martín-Moruno, P. (2008). On the generalised Chaplygin gas: worse than a big rip or quieter than a sudden singularity? *Int. Journ. Mod. Phys.* Vol. D17 (No. 4): 2269–2290. URL: arXiv:0707.2390.
- Brandenberger, R. H. (2000). Inflationary cosmology: progress and problems, *Lectures at the International School on Cosmology* (Kish Island, Iran, Jan. 22 — Feb. 4 1999; Proceedings: Kluwer, Dordrecht): p. 48. URL: hep-ph/9910410.
- Cardone, F., Maidanyuk, S. P., Mignani, R. & Olkhovsky, V. S. (2006). Multiple internal reflections during particle and photon tunneling, *Found. Phys. Lett.* Vol. 19 (No. 5): 441–457.
- Carter, B. (1974). Large number coincidences and the anthropic principle in cosmology, *IAU Symposium 63: Confrontation of cosmological theories with observational data*, Dordrecht, Reidel.
- Casadio, R., Finelli, F., Luzzi, M. & Venturi, G. (2005). Improved WKB analysis of cosmological perturbations, *Phys. Rev.* Vol. D71 (No. 4): 043517 [12 pages]. URL: gr-qc/0410092.
- Casadio, R., Finelli, F., Luzzi, M. & Venturi, G. (2005). Improved WKB analysis of slow-roll inflation, *Phys. Rev.* Vol. D72 (No. 10): 103516 [10 pages]. URL: gr-qc/0510103.
- Chaplygin, S. (1904). *Sci. Mom. Moskow Univ. Math. Phys.* Vol. 21: 1.
- DeWitt, B. S. (1967). Quantum theory of gravity. I. The canonical theory, *Phys. Rev.* Vol. 160 (No. 5): 1113–1148.
- Ellis, J. (1998). Particle components of dark matter, *Proc. Natl. Acad. Sci. USA* Vol. 95: 53.
- Esposito, S. (2003). Multibarrier tunneling, *Phys. Rev.* Vol. E67 (No. 1): 016609. URL: quant-ph/0209018.
- Fermor, J. H., (1966). Quantum-mechanical tunneling, *Am. Journ. Phys.* Vol. 34: 1168–1170.
- Finelli, F., Vacca, G. P. & Venturi, G. (1998). Chaotic inflation from a scalar field in nonclassical states, *Phys. Rev.* Vol. D58: 103514 [14 pages].

- Ginzburg, V. L. (1999). What problems of physics and astrophysics seem now to be especially important and interesting (30 years later, already on the verge of XXI century), *Physics - Uspekhi* Vol. 42: 353–272.
- Gurvitz, S. A. & Kälbermann, G. (1987). Decay width and the shift of a quasistationary state, *Phys. Rev. Lett.* Vol. 59: 262–265.
- Hartle, J. B. & Hawking, S. W. (1983). Wave function of the Universe, *Phys. Rev.* Vol. D28 (No. 12): 2960–2975.
- Jakiel, J., Olkhovskiy, V. S. & Recami, E. (1999). Validity of the Hartman effect for all kinds of mean tunnelling times, in *Mysteries, Puzzles and Paradoxes in Quantum Mechanics*, edited by Bonifacio R. (Am. Inst. Phys.; Woodbury, N. Y.), pp. 299–302.
- Kamenshchik, A. Y., Moschella, U. & Pasquier, V. (2001). *Phys. Lett.* Vol. B511: 265. URL: gr-qc/0103004.
- Kragh, H. (1996). *Cosmology and Controversy*, Princeton University Press (NJ, ISBN 0-691-02623-8).
- Landau, L. D. & Lifshitz, E. M. *Quantum mechanics, course of Theoretical Physics*, Vol. 3 (Nauka, Moscow, 1989), p. 768 — [in Russian; eng. variant: Oxford, UK, Pergamon, 1982].
- Levkov, D., Rebbi, C. & Rubakov, V. A. (2002). Tunneling in quantum cosmology: numerical study of particle creation, *Phys. Rev.* Vol. D66 (No. 8): 083516. URL: gr-qc/0206028.
- Linde, A. (1984). Quantum creation of the inflationary Universe, *Lett. Nuov. Cim.* Vol. 39 (No. 2): 401–405.
- Linde, A. (1990). Particle physics and inflationary cosmology (Harwood, Chur, Switzerland): 362 pp.; *Contemporary Concepts in Physics*, v. 5. URL: hep-th/0503203.
- Luzzi, M. (2007). Semiclassical Approximations to Cosmological Perturbations, *Ph. D. thesis* (Advisor: Prof. Giovanni Venturi, University of Bologna): 148 pages. URL: arXiv:0705.3764.
- Maydanyuk, S. P., Olkhovskiy, V. S. & Zaichenko A. K., (2002). The method of multiple internal reflections in description of tunneling evolution of nonrelativistic particles and photons, *Journ. Phys. Stud.* Vol. 6 (No. 1): 1–16. URL: nucl-th/0407108.
- Maydanyuk, S. P., Olkhovskiy V. S. & Belchikov S. V., (2002). The method of multiple internal reflections in description of nuclear decay, *Probl. At. Sci. Tech. (Voprosi atomnoi nauki we tehniki, RFNC-VNIIEF, Sarov, Russia)* Vol. 1: 16–19. URL: nucl-th/0409037.
- Maydanyuk, S. P. (2003). Time analysis of tunneling processes in nuclear collisions and decays, *Ph. D. dissertation* (Supervisor: Prof. V. S. Olkhovskiy, Kiev), p. 147 [in Ukrainian].
- Maydanyuk, S. P. (2008). Wave function of the Universe in the early stage of its evolution, *Europ. Phys. Journ.* Vol. C57 (No. 4): 769–784. URL: arxiv.org:0707.0585.
- Maydanyuk, S. P. (2010). A fully quantum method of determination of penetrability and reflection coefficients in quantum FRW model with radiation, *Int. Journ. Mod. Phys.* Vol. D19 (No. 4): 392–435. URL: arXiv:0812.5081.
- Maydanyuk, S. P. (2011). Resonant structure of space-time of early universe, *Europ. Phys. Journ. Plus* Vol. 126 (No. 8): 76. URL: arXiv:1005.5447.
- Maydanyuk, S. P. & Belchikov, S. V. (2011). Problem of nuclear decay by proton emission in fully quantum consideration: calculations of penetrability and role of boundary conditions, *Journ. Mod. Phys.* Vol. 2: 572–585.
- McVoy, K. W., Heller, L. & Bolsterli, M. (1967). Optical analysis of potential well resonances, *Rev. Mod. Phys.* Vol. 39 (No. 1): 245–258.
- Moffat, J. (1993). Superluminary universe: A possible solution to the initial value problem in cosmology, *Int. J. Mod. Phys.* Vol. D2 (No. 3): 351–366. URL: gr-qc/9211020.

- Monerat, G. A., Oliveira-Neto, G., Correa Silva, E. V. et al. (2007). Dynamic of the early universe and the initial condition for inflation in a model with radiation and a Chaplygin gas, *Phys. Rev. D* Vol. D76: 024017 [11 pages].
- Olkhovsky, V. S. & Recami, E. (1992). Recent developments in the time analysis of tunnelling processes, *Physics Reports* Vol. 214 (No. 214): 339–357.
- Olkhovsky, V. S., Recami, E., Raciti, F. & Zaichenko, A. K. (1995). Tunnelling times, the dwell time, and the “Hartman effect”, *J. de Phys. (France) I* Vol. 5: 1351–1365.
- Olkhovsky, V. S. & Maydanyuk, S. P. (2000). Method of multiple internal reflections in description of tunneling evolution through barriers, *Ukr. Phys. Journ.* Vol. 45 (No. 10): 1262–1269. URL: nucl-th/0406035.
- Olkhovsky, V. S., Recami, E. & Salesi, G. (2002). Tunneling through two successive barriers and the Hartman effect, *Europhysics Letters* Vol. 57: 879–884. URL: quant-ph/0002022.
- Olkhovsky, V. S., Recami, E. & Jakiel, J. (2004). Unified time analysis of photon and nonrelativistic particle tunnelling, *Phys. Rep.* Vol. 398: 133–178.
- Olkhovsky, V. S., Recami, E. & Zaichenko, A. K. (2005). Resonant and non-resonant tunneling through a double barrier, *Europhysics Letters* Vol. 70: 712–718. URL: quant-th/0410128.
- Olkhovsky, V. S. & Recami, E. (2008). New developments in the study of time as a quantum observable, *Int. J. Mod. Phys.* Vol. B22: 1877–1897.
- Olkhovsky, V. S. (2010). A retrospective view on the history of the natural sciences in XX-XXI, *Natural Science* Vol. 2 (No. 3): 228–245.
- Olkhovsky, V. S. (2011). On time as a quantum observable canonically conjugate to energy, *Physics – Uspekhi* Vol. 54 (No. 11): 829–835.
- Peacock, J. (1999). *Cosmological Physics*, Cambridge University Press (ISBN 0521422701).
- Petit, J. P. (1988). An interpretation of cosmological model with variable light velocity, *Mod. Phys. Lett.* Vol. A3 (No. 16): 1527–1532.
- Petit, J. P. & Viton, M. (1989). Gauge cosmological model with variable light velocity. Comparizon with QSO observational data, *Mod. Phys. Lett.* Vol. A4: 2201–2210.
- Recami, E. (2004). Superluminal tunneling through successive barriers. Does QM predict infinite group-velocities? *Journal of Modern Optics* Vol. 51: 913–923.
- Rubakov, V. A. (1984). Quantum mechanics in the tunneling universe, *Phys. Lett.* Vol. B 148 (No. 4–5): 280–286.
- Rubakov, V. A. (1999). Quantum cosmology, Proceedings: *Structure formation in the Universe* (Edited by R. G. Crittenden and N. G. Turok, Kluwer): 63–74. URL: gr-qc/9910025.
- Rubakov, V. A. (2005). Introduction to cosmology (RTN Winter School of Strings, Supergravity and Gauge Theories, January 31 – February 4, SISSA, Trieste, Italy): 58 p. URL: pos.sissa.it
- Setterfield, B. & Norman, T. (1987). *The atomic constants, light and time*, Paper for SRI International.
- Trodden, M. & Carroll, S. M. (2003) *TASI Lectures: Introduction of cosmology*, Lectures at the Theoretical Advanced Study Institutes in elementary particle physics (TASI-2003, *Recent Trends in String Theory*, University of Colorado at Boulder, 1–27 Jun 2003; Edited by J. M. Maldacena; Hackensack, World Scientific, 2005; 548 pp.), 82 pp. URL: astro-ph/0401547.
- Troitskii, V. S. (1987). *Astrofizika i kosmicheskaya nauka* Vol. 139: 389–411 [in Russian].
- Tronconi, A., Vacca, G. P. & Venturi, G. (2003). Inflaton and time in the matter-gravity system, *Phys. Rev. D* Vol. D67: 063517 [8 pages].

- Vilenkin, A. (1982). Creation of universes from nothing, *Phys. Lett.* Vol. B117 (No. 1–2): 25–28.
- Vilenkin, A. (1984). Quantum creation of universes, *Phys. Rev.* Vol. D 30 (No. 2): 509–511.
- Vilenkin, A. (1986). Boundary conditions in quantum cosmology, *Phys. Rev.* Vol. D 33 (No. 12): 3560–3569.
- Vilenkin, A. (1994). Approaches to quantum cosmology, *Phys. Rev.* Vol. D 50 (No. 12): 2581–2594. URL: gr-qc/9403010.
- Weinberg, S. *Gravitatsiya we kosmologiya: printsipi we prilozheniya obschei teorii otnositel'nosti* (Mir, Moskva, 1975), 696 p.. — [in Russian; eng. variant: Weinberg, S. *Gravitation and cosmology: principles and applications of the General theory of relativity*, MIT, John Wiley and Sons, New York - London - Sydney - Toronto, 1972].
- Wheeler, J. A. (1968). *Batelle Rencontres*, Benjamin, New York.
- Zaichenko, A. K. & Kashuba, I. E. (2001). Evaluation of the parabolic cylinder function in the context of nuclear physics, Kyiv, 14 p. (Preprint/ National Academy of Sciences of Ukraine. Institute for Nuclear Research; KINR-01-3).
- Zakhariev, B. N., Kostov, N. A. & Plehanov, E. B. (1990). Exactly solvable one- and manychannel models (Quantum intuition lessons), *Physics of elementary particles and atomic nuclei* Vol. 21 (Iss. 4): 914–962. — [in Russian].
- Zel'dovich, Ya. B., & Starobinsky, A. A. (1984). Quantum creation of a universe in a nontrivial topology, *Sov. Astron. Lett.* Vol. 10 (No. 3): 135.

Spontaneous Supersymmetry Breaking, Localization and Nicolai Mapping in Matrix Models

Fumihiko Sugino
Okayama Institute for Quantum Physics
Japan

1. Introduction

Supersymmetry (SUSY) is a symmetry between bosons and fermions. It leads to degeneracies of mass spectra between bosons and fermions. Although such degeneracies have not been observed yet, there is a possibility for SUSY being realized in nature as a spontaneously broken symmetry. From a theoretical viewpoint, SUSY provides a unified framework describing physics in high energy regime beyond the standard model (Sohnius, 1985). Spontaneous breaking of SUSY is one of the most interesting phenomena in quantum field theory. Since in general SUSY cannot be broken by radiative corrections at the perturbative level, its spontaneous breaking requires understanding of nonperturbative aspects of quantum field theory (Witten, 1981). In particular, recent developments in nonperturbative aspects of string theory heavily rely on the presence of SUSY. Thus, in order to deduce predictions to the real world from string theory, it is indispensable and definitely important to investigate a mechanism of spontaneous SUSY breaking in a nonperturbative framework of strings. Since one of the most promising approaches of nonperturbative formulations of string theory is provided by large- N matrix models (Banks et al., 1997; Dijkgraaf et al., 1997; Ishibashi et al., 1997), it will be desirable to understand how SUSY can be spontaneously broken in the large- N limit of simple matrix models as a first step. Analysis of SUSY breaking in simple matrix models would help us find a mechanism which is responsible for possible spontaneous SUSY breaking in nonperturbative string theory.

For this purpose, it is desirable to treat systems in which spontaneous SUSY breaking takes place in the path-integral formalism, because matrix models are usually defined by the path integrals, namely integrals over matrix variables. In particular, IIB matrix model defined in zero dimension can be formulated only by the path-integral formalism (Ishibashi et al., 1997). Motivated by this, we discuss in the next section the path-integral formalism for (discretized) SUSY quantum mechanics, which includes cases that SUSY is spontaneously broken. Analogously to the situation of ordinary spontaneous symmetry breaking, we introduce an external field to choose one of degenerate broken vacua to detect spontaneous SUSY breaking. The external field plays the same role as a magnetic field in the Ising model introduced to detect the spontaneous magnetization. For the supersymmetric system, we deform the boundary condition for fermions from the periodic boundary condition (PBC) to a twisted boundary condition (TBC) with twist α , which can be regarded as such an external

field. If a supersymmetric system undergoes spontaneous SUSY breaking, the partition function with the PBC for all the fields, Z_{PBC} , which usually corresponds to the Witten index, is expected to vanish (Witten, 1982). Then, the expectation values of observables, which are normalized by Z_{PBC} , would be ill-defined or indefinite. By introducing the twist, the partition function is regularized and the expectation values become well-defined. It is an interesting aspect of our external field for SUSY breaking, which is not seen in spontaneous breaking of ordinary (bosonic) symmetry.

Notice that our argument can be applied to systems in less than one-dimension, for example discretized SUSY quantum mechanics with a finite number of discretized time steps. Spontaneous SUSY breaking is observed even in such simple systems with lower degrees of freedom. Also, we give some argument that an analog of the Mermin-Wagner-Coleman theorem (Coleman, 1973; Mermin & Wagner, 1966) does not hold for SUSY. Thus, cooperative phenomena are not essential to cause spontaneous SUSY breaking, which makes a difference from spontaneous breaking of the ordinary (bosonic) symmetry.

In this setup, we compute an order parameter of SUSY breaking such as the expectation value of an auxiliary field in the presence of the external field. If it remains nonvanishing after turning off the external field, it shows that SUSY is spontaneously broken because it implies that the effect of the infinitesimal external field we have introduced at the beginning remains. Here, it should be noticed that, if we are interested in the large- N behavior of SUSY matrix models, we have to take the large- N limit before turning off the external field, which is reminiscent of the thermodynamic limit of the Ising model taken before turning off the magnetic field in detecting the spontaneous Z_2 breaking.

In view of this, it is quite important to calculate the partition function in the presence of the external field in the path integral for systems which spontaneously break SUSY. Especially it would be better to calculate it in matrix models at finite N in order to observe breaking/restoration of SUSY in the large- N limit. We address this problem by utilizing two methods: localization and Nicolai mapping (Nicolai, 1979) in sections 3 and 4, respectively.

As for the localization, in section 3 we make change of integration variables in the path integral, which is always possible whether or not the SUSY is explicitly broken (the external field is on or off). It is investigated in detail how the integrand of the partition function with respect to the integral over the auxiliary field behaves as the auxiliary field approaches to zero. It plays a crucial role to understand the localization from the change of variables. For SUSY matrix models with Q -SUSY preserved, the path integral receives contributions only from the fixed points of Q -transformation, which are nothing but the critical points of superpotential, i.e. zeros of the first derivative of superpotential. However, in terms of eigenvalues of matrix variables, an interesting phenomenon arises. Localization attracts the eigenvalues to the critical points of superpotential, while the square of the Vandermonde determinant arising from the measure factor prevents the eigenvalues from collapsing. The dynamics of the eigenvalues is governed by balance of attractive force from the localization and repulsive force from the Vandermonde determinant. Without the external field, contribution to the partition function from each eigenvalue distributed around some critical point is derived for a general superpotential.

In the case that the external field is turned on, computation is still possible, but in section 4 we find that a method by the Nicolai mapping is more effective. Interestingly, the Nicolai mapping works for SUSY matrix models even in the presence of the external field which explicitly breaks SUSY. It enables us to calculate the partition function at least in the leading nontrivial order of an expansion with respect to the small external field for finite N . We can

take the large- N limit of our result before turning off the external field and detect whether SUSY is spontaneously broken or not in the large- N limit. For illustration, we obtain large- N solutions for a SUSY matrix model with double-well potential.

Section 5 is devoted to summarize the results and discuss future directions.

This chapter is mainly based on the two papers (Kuroki & Sugino, 2010; 2011).

2. Preliminaries on SUSY quantum mechanics

As a preparation to discuss large- N SUSY matrix models, in this section we present some preliminary results on SUSY quantum mechanics.

Let us start with a system defined by the Euclidean (Wick-rotated) action:

$$S^{\text{QM}} = \int_0^\beta dt \left[\frac{1}{2} B^2 + iB (\dot{\phi} + W'(\phi)) + \bar{\psi} (\dot{\psi} + W''(\phi)\psi) \right], \quad (1)$$

where ϕ is a real scalar field, $\psi, \bar{\psi}$ are fermions, and B is an auxiliary field. The dot means the derivative with respect to the Euclidean time $t \in [0, \beta]$. For a while, all the fields are supposed to obey the PBC. $W(\phi)$ is a real function of ϕ called superpotential, and the prime ($'$) represents the ϕ -derivative.

S^{QM} is invariant under one-dimensional $\mathcal{N} = 2$ SUSY transformations generated by Q and \bar{Q} . They act on the fields as

$$Q\phi = \psi, \quad Q\psi = 0, \quad Q\bar{\psi} = -iB, \quad QB = 0, \quad (2)$$

and

$$\bar{Q}\phi = -\bar{\psi}, \quad \bar{Q}\bar{\psi} = 0, \quad \bar{Q}\psi = -iB + 2\dot{\phi}, \quad \bar{Q}B = 2i\dot{\psi}, \quad (3)$$

with satisfying the algebra

$$Q^2 = \bar{Q}^2 = 0, \quad \{Q, \bar{Q}\} = 2\partial_t. \quad (4)$$

Note that S^{QM} can be written as the Q - or $Q\bar{Q}$ -exact form:

$$S^{\text{QM}} = Q \int dt \bar{\psi} \left\{ \frac{i}{2} B - (\dot{\phi} + W'(\phi)) \right\} \quad (5)$$

$$= Q\bar{Q} \int dt \left(\frac{1}{2} \bar{\psi}\psi + W(\phi) \right). \quad (6)$$

For demonstration, let us consider the case of the derivative of the superpotential

$$W'(\phi) = g(\phi^2 - \mu^2) \quad \text{with} \quad g, \mu^2 \in \mathbf{R}. \quad (7)$$

For $\mu^2 < 0$, the classical minimum is given by the static configuration $\phi = 0$, with its energy $E_0 = \frac{1}{2}g^2\mu^4 > 0$ implying spontaneous SUSY breaking. Then, $B = ig\mu^2 \neq 0$ from the equation of motion, leading to $Q\bar{\psi}, \bar{Q}\psi \neq 0$, which also means the SUSY breaking.

For $\mu^2 > 0$, the classical minima $\phi = \pm\sqrt{\mu^2}$ are zero-energy configurations. It is known that the quantum tunneling (instantons) between the minima resolves the degeneracy giving positive energy to the ground state. SUSY is broken also in this case.

Next, let us consider quantum aspects of the SUSY breaking in this model. For later discussions on matrix models, it is desirable to observe SUSY breaking via the path-integral formalism, that is, by seeing the expectation value of some field. We take $\langle B \rangle$ (or $\langle B^n \rangle$)

($n = 1, 2, \dots$) as such an order parameter. Whichever μ^2 is positive or negative, the SUSY is broken, so the ground state energy E_0 is positive. Then, for each of the energy levels E_n ($0 < E_0 < E_1 < E_2 < \dots$), the SUSY algebra¹

$$\{Q, \bar{Q}\} = 2E_n, \quad Q^2 = \bar{Q}^2 = 0 \quad (8)$$

leads to the SUSY multiplet formed by bosonic and fermionic states

$$|b_n\rangle = \frac{1}{\sqrt{2E_n}} \bar{Q}|f_n\rangle, \quad |f_n\rangle = \frac{1}{\sqrt{2E_n}} Q|b_n\rangle. \quad (9)$$

As a convention, we assume that $|b_n\rangle$ and $|f_n\rangle$ have the fermion number charges $F = 0$ and 1 , respectively. Since the Q -transformation for B in (2) is expressed as $[Q, B] = 0$ in the operator formalism, we can see that

$$\langle b_n|B|b_n\rangle = \langle f_n|B|f_n\rangle \quad (10)$$

holds for each n . Then, it turns out that the unnormalized expectation value of B vanishes²:

$$\begin{aligned} \langle B \rangle' &\equiv \int_{\text{PBC}} d(\text{fields}) B e^{-S^{\text{QM}}} = \text{Tr} \left[B (-1)^F e^{-\beta H} \right] \\ &= \sum_{n=0}^{\infty} (\langle b_n|B|b_n\rangle - \langle f_n|B|f_n\rangle) e^{-\beta E_n} = 0. \end{aligned} \quad (11)$$

This observation shows that, in order to judge SUSY breaking from the expectation value of B , we should choose either of the SUSY broken ground states ($|b_0\rangle$ or $|f_0\rangle$) and see the expectation value with respect to the chosen ground state. The situation is somewhat analogous to the case of spontaneous breaking of ordinary (bosonic) symmetry.

However, differently from the ordinary case, when SUSY is broken, the supersymmetric partition function vanishes:

$$Z_{\text{PBC}}^{\text{QM}} = \int_{\text{PBC}} d(\text{fields}) e^{-S^{\text{QM}}} = \text{Tr} \left[(-1)^F e^{-\beta H} \right] \quad (12)$$

$$= \sum_{n=0}^{\infty} (\langle b_n|b_n\rangle - \langle f_n|f_n\rangle) e^{-\beta E_n} = 0, \quad (13)$$

where the normalization $\langle b_n|b_n\rangle = \langle f_n|f_n\rangle = 1$ was used. So, the expectation values normalized by $Z_{\text{PBC}}^{\text{QM}}$ could be ill-defined (Kanamori et al., 2008a;b).

2.1 Twisted boundary condition

To detect spontaneous breaking of ordinary symmetry, some external field is introduced so that the ground state degeneracy is resolved to specify a single broken ground state. The external field is turned off after taking the thermodynamic limit, then we can judge whether spontaneous symmetry breaking takes place or not, seeing the value of the corresponding order parameter. (For example, to detect the spontaneous magnetization in the Ising model, the external field is a magnetic field, and the corresponding order parameter is the expectation value of the spin operator.)

¹ In the operator formalism, $\bar{Q}, \bar{\psi}$ are regarded as hermitian conjugate to Q, ψ , respectively.

² Furthermore, $\langle B^n \rangle' = 0$ ($n = 1, 2, \dots$) can be shown.

We will do a similar thing also for the case of spontaneous SUSY breaking. For this purpose, let us change the boundary condition for the fermions to the TBC:

$$\psi(t + \beta) = e^{i\alpha}\psi(t), \quad \bar{\psi}(t + \beta) = e^{-i\alpha}\bar{\psi}(t), \quad (14)$$

then the twist α can be regarded as an external field. Other fields remain intact. As seen shortly in section 2.1.1, the partition function with the TBC corresponds to the expression (12) with $(-1)^F$ replaced by $(-e^{-i\alpha})^F$:

$$Z_\alpha^{\text{QM}} \equiv -e^{-i\alpha} \int_{\text{TBC}} d(\text{fields}) e^{-S^{\text{QM}}} = \text{Tr} \left[(-e^{-i\alpha})^F e^{-\beta H} \right] \quad (15)$$

$$= \sum_{n=0}^{\infty} \left(\langle b_n | b_n \rangle - e^{-i\alpha} \langle f_n | f_n \rangle \right) e^{-\beta E_n} = \left(1 - e^{-i\alpha} \right) \sum_{n=0}^{\infty} e^{-\beta E_n}. \quad (16)$$

Then, the normalized expectation value of B under the TBC becomes

$$\begin{aligned} \langle B \rangle_\alpha &\equiv \frac{1}{Z_\alpha^{\text{QM}}} \text{Tr} \left[B (-e^{-i\alpha})^F e^{-\beta H} \right] \\ &= \frac{1}{Z_\alpha^{\text{QM}}} \sum_{n=0}^{\infty} \left(\langle b_n | B | b_n \rangle - e^{-i\alpha} \langle f_n | B | f_n \rangle \right) e^{-\beta E_n} \\ &= \frac{\sum_{n=0}^{\infty} \langle b_n | B | b_n \rangle e^{-\beta E_n}}{\sum_{n=0}^{\infty} e^{-\beta E_n}} = \frac{\sum_{n=0}^{\infty} \langle f_n | B | f_n \rangle e^{-\beta E_n}}{\sum_{n=0}^{\infty} e^{-\beta E_n}}. \end{aligned} \quad (17)$$

Note that the factors $(1 - e^{-i\alpha})$ in the numerator and the denominator cancel each other, and thus $\langle B \rangle_\alpha$ does not depend on α even for finite β . As a result, $\langle B \rangle_\alpha$ is equivalent to the expectation value taken over one of the ground states and its excitations $\{|b_n\rangle\}$ (or $\{|f_n\rangle\}$). The normalized expectation value of B under the PBC was of the indefinite form $0/0$, which is now regularized by introducing the parameter α . The expression (17) is well-defined. On the other hand, from the Q -transformation $\psi = [Q, \phi]$, we have

$$\langle b_n | \phi | b_n \rangle = \langle f_n | \phi | f_n \rangle + \frac{1}{\sqrt{2E_n}} \langle f_n | \psi | b_n \rangle. \quad (18)$$

The second term is a transition between bosonic and fermionic states via the fermionic operator ψ , which does not vanish in general. Thus, differently from $\langle B \rangle_\alpha$, the expectation value of ϕ becomes

$$\begin{aligned} \langle \phi \rangle_\alpha &= \frac{1}{Z_\alpha^{\text{QM}}} \text{Tr} \left[\phi (-e^{-i\alpha})^F e^{-\beta H} \right] \\ &= \frac{1}{Z_\alpha^{\text{QM}}} \sum_{n=0}^{\infty} \left(\langle b_n | \phi | b_n \rangle - e^{-i\alpha} \langle f_n | \phi | f_n \rangle \right) e^{-\beta E_n} \\ &= \frac{\sum_{n=0}^{\infty} \langle f_n | \phi | f_n \rangle e^{-\beta E_n}}{\sum_{n=0}^{\infty} e^{-\beta E_n}} + \frac{1}{1 - e^{-i\alpha}} \frac{\sum_{n=0}^{\infty} \langle f_n | \psi | b_n \rangle \frac{1}{\sqrt{2E_n}} e^{-\beta E_n}}{\sum_{n=0}^{\infty} e^{-\beta E_n}}. \end{aligned} \quad (19)$$

When $\langle f_n | \psi | b_n \rangle \neq 0$ for some n , the second term is α -dependent and diverges as $\alpha \rightarrow 0$. The divergence comes from the transition between $|b_n\rangle$ and $|f_n\rangle$. Since the two states are transformed to each other by the (broken) SUSY transformation, we can say that they should belong to the separate superselection sectors, in analogy to spontaneous breaking of ordinary (bosonic) symmetry. Thus, the divergence of $\langle \phi \rangle_\alpha$ as $\alpha \rightarrow 0$ implies that the superselection rule does not hold in the system.

2.1.1 Partition function with the twist α

We here show that the partition function with the TBC for the fermions (14) can be expressed in the form (15).

Let \hat{b}, \hat{b}^\dagger be annihilation and creation operators of the fermions:

$$\hat{b}^2 = (\hat{b}^\dagger)^2 = 0, \quad \{\hat{b}, \hat{b}^\dagger\} = 1, \quad (20)$$

and they are represented on the Fock space $\{|0\rangle, |1\rangle\}$ as

$$\hat{b}|0\rangle = 0, \quad \hat{b}^\dagger|0\rangle = |1\rangle. \quad (21)$$

We assume that $|0\rangle, |1\rangle$ have the fermion numbers $F = 0, 1$, respectively.

The coherent states $|\psi\rangle, \langle\bar{\psi}|$ satisfying

$$\hat{b}|\psi\rangle = \psi|\psi\rangle, \quad \langle\bar{\psi}|\hat{b}^\dagger = \langle\bar{\psi}|\bar{\psi} \quad (22)$$

($\psi, \bar{\psi}$ are Grassmann numbers, and anticommute with \hat{b}, \hat{b}^\dagger .) are explicitly constructed as

$$|\psi\rangle = |0\rangle - \psi|1\rangle = e^{-\psi\hat{b}^\dagger}|0\rangle, \quad \langle\bar{\psi}| = \langle 0| - \langle 1|\bar{\psi} = \langle 0|e^{-\hat{b}\bar{\psi}}. \quad (23)$$

Also,

$$|0\rangle = \int d\psi \psi|\psi\rangle, \quad \langle 0| = \int d\bar{\psi} \langle\bar{\psi}|\bar{\psi}, \quad |1\rangle = -\int d\psi |\psi\rangle, \quad \langle 1| = \int d\bar{\psi} \langle\bar{\psi}|. \quad (24)$$

Thus, we can obtain

$$\begin{aligned} \text{Tr} \left[(-e^{-i\alpha})^F e^{-\beta H} \right] &= \langle 0|e^{-\beta H}|0\rangle - e^{-i\alpha} \langle 1|e^{-\beta H}|1\rangle \\ &= \int d\bar{\psi} d\psi (e^{-i\alpha} + \psi\bar{\psi}) \langle\bar{\psi}|e^{-\beta H}|\psi\rangle \\ &= e^{-i\alpha} \int d\bar{\psi} d\psi \exp(e^{i\alpha} \psi\bar{\psi}) \langle\bar{\psi}|e^{-\beta H}|\psi\rangle. \end{aligned} \quad (25)$$

Since the bosonic part of H is obvious, below we focus on the fermionic part $H_F = \hat{b}^\dagger W'' \hat{b}$. Dividing the interval β into M short segments of length ε : $\beta = M\varepsilon$ in (25) and applying the relations

$$\langle\bar{\psi}|\psi\rangle = e^{\bar{\psi}\psi}, \quad 1 = \int d\bar{\psi} d\psi |\psi\rangle e^{\bar{\psi}\psi} \langle\bar{\psi}| \quad (26)$$

to each segment, we have the following expression:

$$\text{Tr} \left[(-e^{-i\alpha})^F e^{-\beta H_F} \right] = -e^{-i\alpha} \int \left(\prod_{j=1}^M d\psi_j d\bar{\psi}_j \right) \exp \left[-\varepsilon \sum_{j=1}^M \bar{\psi}_j \left(\frac{\psi_{j+1} - \psi_j}{\varepsilon} + W'' \psi_j \right) \right] \quad (27)$$

with

$$\psi_{M+1} = e^{i\alpha} \psi_1, \quad (28)$$

or

$$\text{Tr} \left[(-e^{-i\alpha})^F e^{-\beta H_F} \right] = -e^{-i\alpha} \int \left(\prod_{j=1}^M d\psi_j d\bar{\psi}_j \right) \exp \left[-\varepsilon \sum_{j=1}^M \left(-\frac{\bar{\psi}_j - \bar{\psi}_{j-1}}{\varepsilon} + \bar{\psi}_j W'' \right) \psi_j \right] \quad (29)$$

with

$$\bar{\psi}_0 = e^{i\alpha} \bar{\psi}_M. \quad (30)$$

Since (28) and (30) correspond to (14) in the continuum limit $\varepsilon \rightarrow 0, M \rightarrow \infty$ with $\beta = M\varepsilon$ fixed, we find that the formula (15) holds.

2.2 Discretized SUSY quantum mechanics

In this subsection, we consider a discretized system of (1), namely the Euclidean time is discretized as $t = 1, \dots, T$. The action is written as

$$S^{\text{dQM}} = Q \sum_{t=1}^T \bar{\psi}(t) \left\{ \frac{i}{2} B(t) - (\phi(t+1) - \phi(t) + W'(\phi(t))) \right\} \quad (31)$$

$$= \sum_{t=1}^T \left[\frac{1}{2} B(t)^2 + iB(t) \{ \phi(t+1) - \phi(t) + W'(\phi(t)) \} \right. \\ \left. + \bar{\psi}(t) \{ \psi(t+1) - \psi(t) + W''(\phi(t)) \psi(t) \} \right], \quad (32)$$

where the Q -SUSY is of the same form as in (2). As is seen by the Q -exact form (31), the action is Q -invariant and the Q -SUSY is preserved upon the discretization (Catterall, 2003). On the other hand, the \bar{Q} -SUSY can not be preserved by the discretization in the case of $T \geq 2$.

When T is finite, the partition function or various correlators are expressed as a finite number of integrals with respect to field variables. So, at first sight, one might expect that spontaneous breaking of the SUSY could not take place, because of a small number of the degrees of freedom. In what follows, we will demonstrate that the expectation is not correct, and that the SUSY can be broken even in such a finite system.

Expressing as S_α^{dQM} the action (32) under the TBC

$$\phi(T+1) = \phi(1), \quad \psi(T+1) = e^{i\alpha} \psi(1), \quad (33)$$

the partition function

$$Z_\alpha^{\text{dQM}} \equiv \left(\frac{-1}{2\pi} \right)^T \int \prod_{t=1}^T (dB(t) d\phi(t) d\psi(t) d\bar{\psi}(t)) e^{-S_\alpha^{\text{dQM}}} \quad (34)$$

is computed to be

$$Z_\alpha^{\text{dQM}} = (-1)^T (1 - e^{i\alpha}) C_T, \quad (35)$$

$$C_T \equiv \int \left(\prod_{t=1}^T \frac{d\phi(t)}{\sqrt{2\pi}} \right) \exp \left[-\frac{1}{2} \sum_{t=1}^T (\phi(t+1) - \phi(t) + W'(\phi(t)))^2 \right]. \quad (36)$$

Here we used

$$\int \left(\prod_{t=1}^T \frac{d\phi(t)}{\sqrt{2\pi}} \right) \left[\prod_{t=1}^T (-1 + W''(\phi(t))) - (-1)^T \right] \\ \times \exp \left[-\frac{1}{2} \sum_{t=1}^T (\phi(t+1) - \phi(t) + W'(\phi(t)))^2 \right] = 0 \quad (37)$$

for the superpotential (7), which is derived from the Nicolai mapping (Nicolai, 1979). (Note the factor $\left[\prod_{t=1}^T (-1 + W''(\phi(t))) - (-1)^T \right]$ is equal to the fermion determinant under the PBC.) Also, C_T is positive definite.

Similarly, for the normalized expectation value

$$\langle B(t) \rangle_\alpha \equiv \frac{1}{Z_\alpha^{\text{dQM}}} \left(\frac{-1}{2\pi} \right)^T \int \prod_{t=1}^T (dB(t) d\phi(t) d\psi(t) d\bar{\psi}(t)) B(t) e^{-S_\alpha^{\text{dQM}}}, \quad (38)$$

we use the Nicolai mapping to have

$$\begin{aligned} \langle B(t) \rangle_\alpha &= \frac{1}{Z_\alpha^{\text{dQM}}} (-1)^T (1 - e^{i\alpha}) \int \left(\prod_{t=1}^T \frac{d\phi(t)}{\sqrt{2\pi}} \right) (-i) (\phi(t+1) - \phi(t) + W'(\phi(t))) \\ &\quad \times \exp \left[-\frac{1}{2} \sum_{t=1}^T (\phi(t+1) - \phi(t) + W'(\phi(t)))^2 \right] \\ &= \frac{1}{C_T} \int \left(\prod_{t=1}^T \frac{d\phi(t)}{\sqrt{2\pi}} \right) (-i) (\phi(t+1) - \phi(t) + W'(\phi(t))) \\ &\quad \times \exp \left[-\frac{1}{2} \sum_{t=1}^T (\phi(t+1) - \phi(t) + W'(\phi(t)))^2 \right]. \end{aligned} \quad (39)$$

The factor $(-1)^T (1 - e^{i\alpha})$ was canceled, and $\langle B(t) \rangle_\alpha$ does not depend on α , again. The result (39) is finite and well-defined. By using the Nicolai mapping, it is straightforward to generalize this result to the case of W' being a general polynomial

$$W'(\phi) = g_p \phi^p + g_{p-1} \phi^{p-1} + \dots + g_0. \quad (40)$$

We find that (39) holds and it is finite and well-defined for even p , and that $\lim_{\alpha \rightarrow 0} \langle B(t) \rangle_\alpha = 0$ for odd p .

2.2.1 No analog of Mermin-Wagner-Coleman theorem for SUSY

As claimed in the Mermin-Wagner-Coleman theorem (Coleman, 1973; Mermin & Wagner, 1966), continuous bosonic symmetry cannot be spontaneously broken at the quantum level in the dimensions of two or lower. In dimensions $D \leq 2$, although the symmetry might be broken at the classical level, in computing quantum corrections to a classical (nonzero) value of a corresponding order parameter, one encounters infrared (IR) divergences from loops of a massless boson. It indicates that the conclusion of the symmetry breaking from the classical value is not reliable at the quantum level any more. It is a manifestation of the Mermin-Wagner-Coleman theorem.

Here, we consider whether an analog of the Mermin-Wagner-Coleman theorem for SUSY holds or not. Naively, since loops of a massless fermion ("would-be Nambu-Goldstone fermion") would be dangerous in the dimension one or lower, we might be tempted to expect that SUSY could not be spontaneously broken at the quantum level in the dimension of one or lower. However, this expectation is not correct. Because the twist α in our setting can also be regarded as an IR cutoff for the massless fermion, the finiteness of (39) shows that $\langle B(t) \rangle_\alpha$ is free from IR divergences and well-defined at the quantum level for less than one-dimension. (For one-dimensional case, (17) has no α -dependence, thus no IR divergences.)

We can see it more explicitly in perturbative calculations. Let us consider the superpotential (7) with $\mu^2 < 0$, where the classical configuration $\phi(t) = 0$ gives $B(t) = ig\mu^2$. If the theorem held, quantum corrections should modify this classical value to zero, and

there we should come across IR divergences owing to a massless fermion. Although we have obtained the finite result (39), the following perturbative analysis would clarify a role played by the massless fermion. We evaluate quantum corrections to the classical value of $B(t)$ perturbatively. Under the mode expansions

$$\begin{aligned}\phi(t) &= \frac{1}{\sqrt{T}} \sum_{n=-(T-1)/2}^{(T-1)/2} \tilde{\phi}_n e^{i2\pi nt/T} \quad \text{with} \quad \tilde{\phi}_n^* = \tilde{\phi}_{-n}, \\ \psi(t) &= \frac{1}{\sqrt{T}} \sum_{n=-(T-1)/2}^{(T-1)/2} \tilde{\psi}_n e^{i(2\pi n + \alpha)t/T}, \\ \bar{\psi}(t) &= \frac{1}{\sqrt{T}} \sum_{n=-(T-1)/2}^{(T-1)/2} \tilde{\bar{\psi}}_n e^{-i(2\pi n + \alpha)t/T},\end{aligned}\tag{41}$$

free propagators are

$$\begin{aligned}\langle \tilde{\phi}_{-n} \tilde{\phi}_m \rangle_{\text{free}} &= \frac{\delta_{nm}}{4 \sin^2 \left(\frac{\pi n}{T} \right) + M^2}, \\ \langle \tilde{\psi}_n \tilde{\bar{\psi}}_m \rangle_{\text{free}} &= \frac{\delta_{nm}}{e^{i(2\pi n + \alpha)/T} - 1}\end{aligned}\tag{42}$$

with $M^2 \equiv -2g^2\mu^2$. Here we consider the case of odd T for simplicity of the mode expansion. Note that the boson is massive while the fermion is nearly massless regulated by α . Also, there are three kinds of interactions in S_α^{dQM} (after B is integrated out):

$$\begin{aligned}V_4 &= \sum_{t=1}^T \frac{1}{2} g^2 \phi(t)^4, \\ V_{3B} &= \sum_{t=1}^T g \phi(t)^2 (\phi(t+1) - \phi(t)), \\ V_{3F} &= \sum_{t=1}^T 2g \phi(t) \bar{\psi}(t) \psi(t).\end{aligned}\tag{43}$$

We perturbatively compute the second term of

$$\langle B(t) \rangle_\alpha = ig\mu^2 - i \langle g\phi(t)^2 + \phi(t+1) - \phi(t) \rangle_\alpha\tag{44}$$

up to the two-loop order, and directly see that the nearly massless fermion (“would-be Nambu-Goldstone fermion”) does not contribute and gives no IR singularity. It is easy to see that the tadpole $\langle \phi(t+1) - \phi(t) \rangle_\alpha$ vanishes from the momentum conservation. For $-i \langle g\phi(t)^2 \rangle_\alpha$, the one-loop contribution comes from the diagram (1B) in Figure 1, which consists only of a boson line independent of α . Also, the two-loop diagrams (2BBa), (2BBb), (2BBc) and (2BBd) do not contain fermion lines. The relevant diagrams for the IR divergence at the two-loop order are the last four (2FFa), (2FFb), (2BFa) and (2BFb), which are evaluated

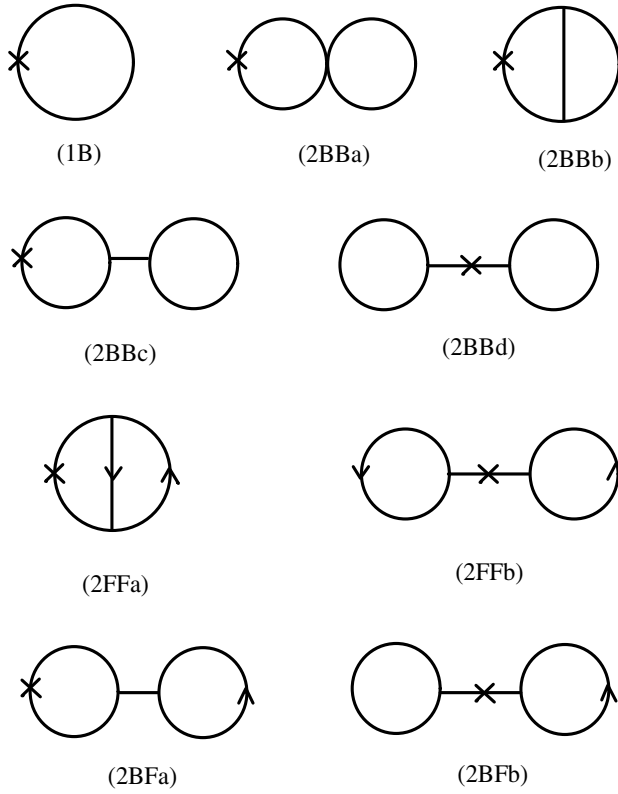

Fig. 1. One- and two-loop diagrams. The crosses represent the insertion of the operator $-ig\phi(t)^2$. The solid lines with (without) arrows mean the fermion (boson) propagators. (1B) is the one-loop diagram, and the other eight are the two-loop diagrams. The diagrams with the name “FF” (“BB”) are constructed by using the interaction vertices V_{3F} twice (V_4 once or V_{3B} twice), and those with “BF” are by using each of V_{3B} and V_{3F} once.

as

$$\begin{aligned}
 (2FFa) &= i \frac{4g^3}{T^2} \sum_{m,k=-(T-1)/2}^{(T-1)/2} \left(\frac{1}{4 \sin^2 \left(\frac{\pi m}{T} \right) + M^2} \right)^2 \frac{1}{e^{i(2\pi k + \alpha)/T} - 1} \frac{1}{e^{i(2\pi(m+k) + \alpha)/T} - 1}, \\
 (2FFb) &= -i \frac{4g^3}{T^2} \frac{1}{M^4} \left(\sum_{m=-(T-1)/2}^{(T-1)/2} \frac{1}{e^{i(2\pi m + \alpha)/T} - 1} \right)^2, \\
 (2BFa) &= -i \frac{4g^3}{T^2} \frac{1}{M^2} \sum_{m=-(T-1)/2}^{(T-1)/2} \left(1 - \frac{M^2}{4 \sin^2 \left(\frac{\pi m}{T} \right) + M^2} \right) \frac{1}{4 \sin^2 \left(\frac{\pi m}{T} \right) + M^2} \\
 &\quad \times \sum_{k=-(T-1)/2}^{(T-1)/2} \frac{1}{e^{i(2\pi k + \alpha)/T} - 1}, \\
 (2BFb) &= -i \frac{4g^3}{T^2} \frac{1}{M^4} \sum_{m=-(T-1)/2}^{(T-1)/2} \left(1 - \frac{M^2}{4 \sin^2 \left(\frac{\pi m}{T} \right) + M^2} \right) \sum_{k=-(T-1)/2}^{(T-1)/2} \frac{1}{e^{i(2\pi k + \alpha)/T} - 1}.
 \end{aligned}
 \tag{45}$$

Each diagram is singular as $\alpha \rightarrow 0$ due to the fermion zero-mode, however it is remarkable that the sum of them vanishes:

$$\begin{aligned} & (2FFa) + (2FFb) + (2BFa) + (2BFb) \\ &= -i \frac{4g^3}{T^2} \frac{1}{M^4} \sum_{m=1}^{T-1} \left[1 - \left(\frac{M^2}{4 \sin^2 \left(\frac{\pi m}{T} \right) + M^2} \right)^2 \right] F(m) \end{aligned} \quad (46)$$

with

$$\begin{aligned} F(m) &\equiv \sum_{k=1}^T \left(1 + \frac{1}{e^{i(2\pi(m+k)+\alpha)/T} - 1} \right) \frac{1}{e^{i(2\pi k+\alpha)/T} - 1} \\ &= \sum_{k=1}^T \frac{1}{e^{i(2\pi k+\alpha)/T} - 1} \left[1 - \frac{e^{-i(2\pi k+\alpha)/T}}{1 - e^{i2\pi m/T}} - \frac{e^{-i(2\pi k+\alpha)/T}}{1 - e^{-i2\pi m/T}} \right] \\ &= \sum_{k=1}^T e^{-i(2\pi k+\alpha)/T} = 0. \end{aligned} \quad (47)$$

Thus, the two-loop contribution turns out to have no α -dependence, and the quantum corrections come only from the boson loops which are IR finite, that is consistent with (39). Since the classical value $ig\mu^2 = -i\frac{M^2}{2g}$ is regarded as $\mathcal{O}(g^{-1})$, and ℓ -loop contributions are of the order $\mathcal{O}(g^{2\ell-1})$, the quantum corrections can not be comparable to the classical value in the perturbation theory. Thus, the conclusion of the SUSY breaking based on the classical value continues to be correct even at the quantum level.

3. Change of variables and localization in SUSY matrix models

As argued in the previous section, in order to discuss spontaneous SUSY breaking in the path-integral formalism of (discretized) SUSY quantum mechanics, we introduce an external field to twist the boundary condition of fermions in the Euclidean time direction and observe whether an order parameter of SUSY breaking remains nonzero after turning off the external field. This motivates us to calculate the partition function in the presence of the external field. In the following, we consider a matrix-model analog of (32)

$$\begin{aligned} S^M &= Q \sum_{t=1}^T N \operatorname{tr} \bar{\psi}(t) \left\{ \frac{i}{2} B(t) - (\phi(t+1) - \phi(t) + W'(\phi(t))) \right\} \\ &= \sum_{t=1}^T N \operatorname{tr} \left[\frac{1}{2} B(t)^2 + iB(t) \{ \phi(t+1) - \phi(t) + W'(\phi(t)) \} \right. \\ &\quad \left. + \bar{\psi}(t) \{ \psi(t+1) - \psi(t) + QW'(\phi(t)) \} \right], \end{aligned} \quad (48)$$

where all variables are $N \times N$ Hermitian matrices. Under the PBC, this action is manifestly invariant under Q -transformation defined in (2). When $N = 1$, it reduces to the discretized SUSY quantum mechanics in section 2.2. We will focus on the simplest case $T = 1$ below. Under the twisted boundary condition (33) with $T = 1$, the action is

$$S_\alpha^M = N \operatorname{tr} \left[\frac{1}{2} B^2 + iBW'(\phi) + \bar{\psi} \left(e^{i\alpha} - 1 \right) \psi + \bar{\psi} QW'(\phi) \right], \quad (49)$$

and the partition function is defined by

$$Z_\alpha^M \equiv (-1)^{N^2} \int d^{N^2} B d^{N^2} \phi \left(d^{N^2} \psi d^{N^2} \bar{\psi} \right) e^{-S_\alpha^M}, \tag{50}$$

where we fix the normalization of the measure as

$$\int d^{N^2} \phi e^{-N \text{tr}(\frac{1}{2} \phi^2)} = \int d^{N^2} B e^{-N \text{tr}(\frac{1}{2} B^2)} = 1, \quad (-1)^{N^2} \int \left(d^{N^2} \psi d^{N^2} \bar{\psi} \right) e^{-N \text{tr}(\bar{\psi} \psi)} = 1. \tag{51}$$

Explicitly, when $W'(\phi)$ is a general polynomial (40), (49) becomes

$$S_\alpha^M = N \text{tr} \left[\frac{1}{2} B^2 + i B W'(\phi) + \bar{\psi} \left(e^{i\alpha} - 1 \right) \psi + \sum_{k=1}^p g_k \sum_{\ell=0}^{k-1} \bar{\psi} \phi^\ell \psi \phi^{k-\ell-1} \right]. \tag{52}$$

Notice the ordering of the matrices in the last term. We see that the effect of the external field remains even after the reduction to zero dimension ($T = 1$). When $\alpha = 0$, $S_{\alpha=0}^M$ is invariant under Q and \bar{Q} :

$$Q\phi = \psi, \quad Q\psi = 0, \quad Q\bar{\psi} = -iB, \quad QB = 0, \tag{53}$$

and

$$\bar{Q}\phi = -\bar{\psi}, \quad \bar{Q}\bar{\psi} = 0, \quad \bar{Q}\psi = -iB, \quad \bar{Q}B = 0, \tag{54}$$

both of which become broken explicitly in S_α^M by introducing the external field α .

Now let us discuss localization of the integration in Z_α^M . Some aspects are analogous to the discretized SUSY quantum mechanics with $T \geq 2$ under the identification $N^2 = T$ from the viewpoint of systems possessing multi-degrees of freedom, while there are also interesting new phenomena specific to matrix models³. We make a change of variables

$$\phi = \tilde{\phi} + \bar{\epsilon} \psi, \quad \bar{\psi} = \tilde{\bar{\psi}} - i\bar{\epsilon} B, \tag{55}$$

where in the second equation, $\tilde{\bar{\psi}}$ satisfies

$$N \text{tr}(B \tilde{\bar{\psi}}) = 0, \tag{56}$$

namely, $\tilde{\bar{\psi}}$ is orthogonal to B with respect to the inner product $(A_1, A_2) \equiv N \text{tr}(A_1^\dagger A_2)$. Let us take a basis of $N \times N$ Hermitian matrices $\{t^a\}$ ($a = 1, \dots, N^2$) to be orthonormal with respect to the inner product: $N \text{tr}(t^a t^b) = \delta_{ab}$. More explicitly, we take

$$\bar{\epsilon} \equiv i \frac{\text{tr}(B \tilde{\bar{\psi}})}{\text{tr} B^2} = \frac{i}{\mathcal{N}_B^2} N \text{tr}(B \tilde{\bar{\psi}}) \tag{57}$$

with $\mathcal{N}_B \equiv ||B|| = \sqrt{N \text{tr}(B^2)}$ the norm of the matrix B . Notice that for general N $\bar{\psi}$ is an $N \times N$ matrix and that $\bar{\epsilon}$ does not have enough degrees of freedom to parametrize the whole space of $\bar{\psi}$. In fact, $\bar{\epsilon}$ is used to parametrize a single component of $\bar{\psi}$ parallel to B .

If we write (50) as

$$Z_\alpha^M = \int d^{N^2} B \Xi_\alpha(B), \quad \Xi_\alpha(B) \equiv (-1)^{N^2} \int d^{N^2} \phi \left(d^{N^2} \psi d^{N^2} \bar{\psi} \right) e^{-S_\alpha^M}, \tag{58}$$

³ Localization in the discretized SUSY quantum mechanics is discussed in appendix A in ref. (Kuroki & Sugino, 2011).

and consider the change of the variables in $\Xi_\alpha(B)$, B may be regarded as an external variable. The measure $d^{N^2}\bar{\psi}$ can be expressed by the measures associated with $\tilde{\psi}$ and $\bar{\epsilon}$ as

$$d^{N^2}\bar{\psi} = \frac{i}{\mathcal{N}_B} d\bar{\epsilon} d^{N^2-1}\tilde{\psi}, \quad (59)$$

where $d^{N^2-1}\tilde{\psi}$ is explicitly given by introducing the constraint (56) as a delta-function:

$$\begin{aligned} d^{N^2-1}\tilde{\psi} &\equiv (-1)^{N^2-1} d^{N^2}\tilde{\psi} \delta\left(\frac{1}{\mathcal{N}_B} N \operatorname{tr}(B\tilde{\psi})\right) \\ &= (-1)^{N^2-1} \left(\prod_{a=1}^{N^2} d\tilde{\psi}^a\right) \frac{1}{\mathcal{N}_B} \sum_{a=1}^{N^2} B^a \tilde{\psi}^a. \end{aligned} \quad (60)$$

$\tilde{\psi}^a$ and B^a are coefficients in the expansion of $\tilde{\psi}$ and B by the basis $\{t^a\}$:

$$\tilde{\psi} = \sum_{a=1}^{N^2} \tilde{\psi}^a t^a, \quad B = \sum_{a=1}^{N^2} B^a t^a. \quad (61)$$

Notice that the measure on the RHS of (59) depends on B . When $B \neq 0$, we can safely change the variables as in (55) and in terms of them the action becomes

$$S_\alpha^M = N \operatorname{tr} \left[\frac{1}{2} B^2 + i B W'(\tilde{\phi}) + \tilde{\psi} \left((e^{i\alpha} - 1) \psi + Q W'(\tilde{\phi}) \right) - (e^{i\alpha} - 1) i \bar{\epsilon} B \psi \right] \quad (62)$$

with $Q\tilde{\phi} = \psi$.

3.1 $\alpha = 0$ case

Let us first consider the case of the PBC ($\alpha = 0$). $S_{\alpha=0}^M$ does not depend on $\bar{\epsilon}$ as a consequence of its SUSY invariance, because (55) reads

$$\phi = \tilde{\phi} + \epsilon Q\tilde{\phi}, \quad \bar{\psi} = \tilde{\psi} + \bar{\epsilon} Q\tilde{\psi}. \quad (63)$$

Therefore, the contribution to the partition function from $B \neq 0$

$$\tilde{Z}_{\alpha=0} = \int_{\|B\| \geq \epsilon} d^{N^2} B \Xi_{\alpha=0}(B) \quad (0 < \epsilon \ll 1) \quad (64)$$

vanishes due to the integration over $\bar{\epsilon}$ according to (59). Namely, when $\alpha = 0$, the path integral of the partition function (50) is localized to $B = 0$.

For the contribution to the partition function from the vicinity of $B = 0$

$$Z_{\alpha=0}^{(0)} = \int_{\|B\| < \epsilon} d^{N^2} B \Xi_{\alpha=0}(B), \quad (65)$$

when $W'(\phi)$ is given by (40) of degree $p \geq 2$, rescaling as

$$\tilde{\phi} = \mathcal{N}_B^{-\frac{1}{p}} \phi', \quad \tilde{\psi} = \mathcal{N}_B^{\frac{p-1}{p}} \tilde{\psi}', \quad (66)$$

we obtain

$$Z_{\alpha=0}^{(0)} = i \left(\frac{-1}{\sqrt{2\pi}} \right)^{N^2} \left(\int_0^\epsilon d\mathcal{N}_B \frac{1}{\mathcal{N}_B^{1+\frac{1}{p}}} e^{-\frac{1}{2}\mathcal{N}_B^2} \right) \int d\Omega_B \int d^{N^2} \phi' e^{-iN \text{tr}(\Omega_B g_p \phi'^p)} \\ \times \int d^{N^2} \psi \int d\bar{\epsilon} d^{N^2-1} \bar{\psi}' e^{-N \text{tr}[\bar{\psi}' g_p \sum_{\ell=0}^{p-1} \phi'^\ell \psi \phi'^{p-\ell-1}]} \left[1 + \mathcal{O}(\epsilon^{1/p}) \right], \quad (67)$$

where the measure of the B -integral was expressed in terms of polar coordinates in \mathbf{R}^{N^2} as

$$d^{N^2} B = \prod_{a=1}^{N^2} \frac{dB^a}{\sqrt{2\pi}} = \left(\frac{1}{2\pi} \right)^{\frac{N^2}{2}} \mathcal{N}_B^{N^2-1} d\mathcal{N}_B d\Omega_B, \quad (68)$$

and $\Omega_B \equiv \frac{1}{\mathcal{N}_B} B$ represents a unit vector in \mathbf{R}^{N^2} . Since the $\bar{\epsilon}$ -integral vanishes while the integration of \mathcal{N}_B becomes singular at the origin, $Z_{\alpha=0}^{(0)}$ takes an indefinite form ($\infty \times 0$). When $W'(\phi)$ is linear ($p = 1$), the $\bar{\phi}$ -integrals in (65) yield

$$Z_{\alpha=0}^{(0)} = i \left(\frac{-1}{|g_1|} \right)^{N^2} \int_{\|B\| < \epsilon} \left(\prod_{a=1}^{N^2} dB^a \right) \frac{1}{\mathcal{N}_B} e^{-\frac{1}{2}\mathcal{N}_B^2} \prod_{a=1}^{N^2} \delta(B^a) \\ \times \int d^{N^2} \psi \int d\bar{\epsilon} d^{N^2-1} \bar{\psi}' e^{-N \text{tr}(\bar{\psi}' g_1 \psi)}, \quad (69)$$

which is also of indefinite form – the B -integrals diverge while $\int d\bar{\epsilon}$ trivially vanishes. The indefinite form reflects that $Z_{\alpha=0}^{(0)}$ possibly takes a nonzero value if it is evaluated in a well-defined manner.

3.1.1 Unnormalized expectation values

Next, let us consider the unnormalized expectation values of $\frac{1}{N} \text{tr} B^n$ ($n \geq 1$):

$$\left\langle \frac{1}{N} \text{tr} B^n \right\rangle' \equiv \int d^{N^2} B \left(\frac{1}{N} \text{tr} B^n \right) \Xi_{\alpha=0}(B). \quad (70)$$

Since contribution from the region $\|B\| \geq \epsilon$ is shown to be zero by the change of variables (55), we focus on the B -integration around the origin ($\|B\| < \epsilon$).

When $W'(\phi)$ is a polynomial (40) of degree $p \geq 2$, after the rescaling (66) we obtain

$$\left\langle \frac{1}{N} \text{tr} B^n \right\rangle' = i \left(\int_0^\epsilon d\mathcal{N}_B \mathcal{N}_B^{n-1-\frac{1}{p}} e^{-\frac{1}{2}\mathcal{N}_B^2} \right) Y_N \left[1 + \mathcal{O}(\epsilon^{1/p}) \right], \\ Y_N \equiv \left(\frac{-1}{\sqrt{2\pi}} \right)^{N^2} \int d\Omega_B \frac{1}{N} \text{tr}(\Omega_B^n) \int d^{N^2} \phi' e^{-iN \text{tr}(\Omega_B g_p \phi'^p)} \\ \times \int d^{N^2} \psi \int d\bar{\epsilon} d^{N^2-1} \bar{\psi}' e^{-N \text{tr}[\bar{\psi}' g_p \sum_{\ell=0}^{p-1} \phi'^\ell \psi \phi'^{p-\ell-1}]} \quad (71)$$

The \mathcal{N}_B -integral is finite, and it is seen that Y_N definitely vanishes. Thus, the change of variables (55) is possible for any B in evaluating $\left\langle \frac{1}{N} \text{tr} B^n \right\rangle'$ to give the result

$$\left\langle \frac{1}{N} \text{tr} B^n \right\rangle' = 0 \quad (n \geq 1). \quad (72)$$

When $W'(\phi)$ is linear, $\left\langle \frac{1}{N} \text{tr} B^n \right\rangle'$ has the same expression as the RHS of (69) except the integrand multiplied by $\frac{1}{N} \text{tr} B^n$. It leads to a finite result of the B -integration for $n \geq 1$, and (72) is also obtained.

Furthermore, it can be similarly shown that the unnormalized expectation values of multi-trace operators $\prod_{i=1}^k \frac{1}{N} \text{tr} B^{n_i}$ ($n_1, \dots, n_k \geq 1$) vanish:

$$\left\langle \prod_{i=1}^k \frac{1}{N} \text{tr} B^{n_i} \right\rangle' = 0. \tag{73}$$

3.1.2 Localization to $W'(\phi) = 0$, and localization versus Vandermonde

Since (73) means

$$\left\langle e^{-N \text{tr} \left(\frac{u-1}{2} B^2 \right)} \right\rangle' = \sum_{n=0}^{\infty} \frac{1}{n!} \left(-N^2 \frac{u-1}{2} \right)^n \left\langle \left(\frac{1}{N} \text{tr} B^2 \right)^n \right\rangle' = \langle 1 \rangle' = Z_{\alpha=0}^M \tag{74}$$

for an arbitrary parameter u , we may compute $\left\langle e^{-N \text{tr} \left(\frac{u-1}{2} B^2 \right)} \right\rangle'$ to evaluate the partition function $Z_{\alpha=0}^M$. It is independent of the value of u , so u can be chosen to a convenient value to make the evaluation easier.

Taking $u > 0$ and integrating B first, we obtain

$$Z_{\alpha=0}^M = (-1)^{N^2} \int d^{N^2} \phi \left(\frac{1}{u} \right)^{\frac{N^2}{2}} e^{-N \text{tr} \left[\frac{1}{2u} W'(\phi)^2 \right]} \int \left(d^{N^2} \psi d^{N^2} \bar{\psi} \right) e^{-N \text{tr} [\bar{\psi} Q W'(\phi)]}. \tag{75}$$

Then, let us consider the $u \rightarrow 0$ limit. Localization to $W'(\phi) = 0$ takes place because

$$\lim_{u \rightarrow 0} \left(\frac{1}{u} \right)^{\frac{N^2}{2}} e^{-N \text{tr} \left[\frac{1}{2u} W'(\phi)^2 \right]} = (2\pi)^{\frac{N^2}{2}} \prod_{a=1}^{N^2} \delta(W'(\phi)^a). \tag{76}$$

It is important to recognize that $W'(\phi)^a = 0$ for all a implies localization to a continuous space. Namely, if this condition is met, $W'(U^\dagger \phi U)^a = 0$ for $\forall U \in SU(N)$. Thus the original $SU(N)$ gauge symmetry in the matrix model makes the localization continuous in nature. This is characteristic of SUSY matrix models.

The observation above suggests that in order to localize the path integral to discrete points, we should switch to a description in terms of gauge invariant quantities. This motivates us to change the expression of ϕ to its eigenvalues and $SU(N)$ angles as

$$\phi = U \begin{pmatrix} \lambda_1 & & \\ & \ddots & \\ & & \lambda_N \end{pmatrix} U^\dagger, \quad U \in SU(N). \tag{77}$$

This leads to an interesting situation, which is peculiar to SUSY matrix models and is not seen in the (discretized) SUSY quantum mechanics. For a polynomial $W'(\phi)$ given by (40), the partition function (75) becomes

$$Z_{\alpha=0}^M = \left(\frac{1}{u} \right)^{\frac{N^2}{2}} \int d^{N^2} \phi e^{-N \text{tr} \left[\frac{1}{2u} W'(\phi)^2 \right]} \det \left[\sum_{k=1}^p g_k \sum_{\ell=0}^{k-1} \phi^\ell \otimes \phi^{k-\ell-1} \right], \tag{78}$$

after the Grassmann integrals. Note that the $N^2 \times N^2$ matrix $\sum_{k=1}^p g_k \sum_{\ell=0}^{k-1} \phi^\ell \otimes \phi^{k-\ell-1}$ has the eigenvalues $\sum_{k=1}^p g_k \sum_{\ell=0}^{k-1} \lambda_i^\ell \lambda_j^{k-\ell-1}$ ($i, j = 1, \dots, N$). Thus, the fermion determinant can be expressed as

$$\begin{aligned} \det \left[\sum_{k=1}^p g_k \sum_{\ell=0}^{k-1} \phi^\ell \otimes \phi^{k-\ell-1} \right] &= \prod_{i,j=1}^N \left[\sum_{k=1}^p g_k \sum_{\ell=0}^{k-1} \lambda_i^\ell \lambda_j^{k-\ell-1} \right] \\ &= \left(\prod_{i=1}^N W''(\lambda_i) \right) \prod_{i>j} \left(\frac{W'(\lambda_i) - W'(\lambda_j)}{\lambda_i - \lambda_j} \right)^2. \end{aligned} \quad (79)$$

The measure $d^{N^2} \phi$ given in (51) can be also recast to

$$d^{N^2} \phi = \tilde{C}_N \left(\prod_{i=1}^N d\lambda_i \right) \Delta(\lambda)^2 dU, \quad (80)$$

where $\Delta(\lambda) = \prod_{i>j} (\lambda_i - \lambda_j)$ is the Vandermonde determinant, and dU is the $SU(N)$ Haar measure normalized by $\int dU = 1$. \tilde{C}_N is a numerical factor depending only on N determined by

$$\frac{1}{\tilde{C}_N} = \int \left(\prod_{i=1}^N d\lambda_i \right) \Delta(\lambda)^2 e^{-N \sum_{i=1}^N \frac{1}{2} \lambda_i^2}. \quad (81)$$

Plugging these into (78), we obtain

$$\begin{aligned} Z_{\alpha=0}^M &= \tilde{C}_N \int \left(\prod_{i=1}^N d\lambda_i \right) \left(\prod_{i=1}^N W''(\lambda_i) \right) \left\{ \prod_{i>j} \frac{1}{u} \left(W'(\lambda_i) - W'(\lambda_j) \right)^2 \right\} \\ &\quad \times \left(\frac{1}{u} \right)^{\frac{N}{2}} e^{-N \sum_{i=1}^N \frac{1}{2u} W'(\lambda_i)^2}. \end{aligned} \quad (82)$$

In this expression, the factor in the second line forces eigenvalues to be localized at the critical points of the superpotential as $u \rightarrow 0$, while the last factor in the first line, which is proportional to the square of the Vandermonde determinant of $W'(\lambda_i)$, gives repulsive force among eigenvalues which prevents them from collapsing to the critical points. The dynamics of eigenvalues is thus determined by balance of the attractive force to the critical points originating from the localization and the repulsive force from the Vandermonde determinant. This kind of dynamics is not seen in the (discretized) SUSY quantum mechanics.

To proceed with the analysis, let us consider the situation of each eigenvalue λ_i fluctuating around the critical point $\phi_{c,i}$:

$$\lambda_i = \phi_{c,i} + \sqrt{u} \tilde{\lambda}_i \quad (i = 1, \dots, N), \quad (83)$$

where $\tilde{\lambda}_i$ is a fluctuation, and $\phi_{c,1}, \dots, \phi_{c,N}$ are allowed to coincide with each other. Then, the partition function (82) takes the form

$$\begin{aligned} Z_{\alpha=0}^M &= \tilde{C}_N \sum_{\phi_{c,i}} \int \left(\prod_{i=1}^N d\tilde{\lambda}_i \right) \prod_{i=1}^N W''(\phi_{c,i}) \prod_{i>j} \left(W''(\phi_{c,i}) \tilde{\lambda}_i - W''(\phi_{c,j}) \tilde{\lambda}_j \right)^2 \\ &\quad \times e^{-N \sum_{i=1}^N \frac{1}{2} W''(\phi_{c,i})^2 \tilde{\lambda}_i^2} + \mathcal{O}(\sqrt{u}). \end{aligned} \quad (84)$$

Although only the Gaussian factors become relevant as $u \rightarrow 0$, there remain $N(N - 1)$ -point vertices originating from the Vandermonde determinant of $W'(\lambda_i)$ which yield a specific effect of SUSY matrix models.

In the case of $W(\phi) = g_1\phi$, where the corresponding scalar potential $\frac{1}{2}W'(\phi)^2$ is Gaussian, the critical point is only the origin: $\phi_{c,1} = \dots = \phi_{c,N} = 0$. Then, (84) is reduced to

$$Z_{\alpha=0}^M = \tilde{C}_N \int \left(\prod_{i=1}^N d\tilde{\lambda}_i \right) g_1^{N^2} \prod_{i>j} (\tilde{\lambda}_i - \tilde{\lambda}_j)^2 e^{-N \sum_{i=1}^N \frac{1}{2} g_1^2 \tilde{\lambda}_i^2}, \tag{85}$$

where no $\mathcal{O}(\sqrt{u})$ term appears since $W'(\phi)$ is linear. By using (81) we obtain

$$Z_{\alpha=0}^M = (\text{sgn}(g_1))^{N^2} = (\text{sgn}(g_1))^N. \tag{86}$$

For a general superpotential, we change the integration variables as

$$\tilde{\lambda}_i = \frac{1}{W''(\phi_{c,i})} y_i, \tag{87}$$

then the integration of $\tilde{\lambda}_i$ becomes $\int_{-\infty}^{\infty} d\tilde{\lambda}_i \dots = \frac{1}{|W''(\phi_{c,i})|} \int_{-\infty}^{\infty} dy_i \dots$. In the limit $u \rightarrow 0$, (84) is computed to be

$$\begin{aligned} Z_{\alpha=0}^M &= \sum_{\phi_{c,i}} \prod_{i=1}^N \frac{W''(\phi_{c,i})}{|W''(\phi_{c,i})|} \left\{ \tilde{C}_N \int_{-\infty}^{\infty} \left(\prod_{i=1}^N dy_i \right) \Delta(y)^2 e^{-N \sum_{i=1}^N \frac{1}{2} y_i^2} \right\} \\ &= \sum_{\phi_{c,i}} \prod_{i=1}^N \text{sgn}(W''(\phi_{c,i})) \\ &= \left[\sum_{\phi_c: W'(\phi_c)=0} \text{sgn}(W''(\phi_c)) \right]^N. \end{aligned} \tag{88}$$

Note that the last factor in the first line of (88) is nothing but the partition function of the Gaussian case with $g_1 = 1$. The last line of (88) tells that the total partition function is given by the N -th power of the degree of the map $\phi \rightarrow W'(\phi)$.

Furthermore, we consider a case that the superpotential $W(\phi)$ has K nondegenerate critical points a_1, \dots, a_K . Namely, $W'(a_I) = 0$ and $W''(a_I) \neq 0$ for each $I = 1, \dots, K$. The scalar potential $\frac{1}{2}W'(\phi)^2$ has K minima at $\phi = a_1, \dots, a_K$. When N eigenvalues are fluctuating around the minima, we focus on the situation that

the first $\nu_1 N$ eigenvalues λ_i ($i = 1, \dots, \nu_1 N$) are around $\phi = a_1$,

the next $\nu_2 N$ eigenvalues $\lambda_{\nu_1 N + i}$ ($i = 1, \dots, \nu_2 N$) are around $\phi = a_2$,

\dots ,

and the last $\nu_K N$ eigenvalues $\lambda_{\nu_1 N + \dots + \nu_{K-1} N + i}$ ($i = 1, \dots, \nu_K N$) are around $\phi = a_K$,

where ν_1, \dots, ν_K are filling fractions satisfying $\sum_{I=1}^K \nu_I = 1$. Let $Z_{(\nu_1, \dots, \nu_K)}$ be a contribution to the total partition function $Z_{\alpha=0}^M$ from the above configuration. Then,

$$Z_{\alpha=0}^M = \sum_{\nu_1 N, \dots, \nu_K N=0}^N \frac{N!}{(\nu_1 N)! \dots (\nu_K N)!} Z_{(\nu_1, \dots, \nu_K)}. \tag{89}$$

(The sum is taken under the constraint $\sum_{I=1}^K \nu_I = 1$.) Since $Z_{(\nu_1, \dots, \nu_K)}$ is equal to the second line of (88) with $\phi_{c,i}$ fixed as

$$\begin{aligned} \phi_{c,1} &= \dots = \phi_{c,\nu_1 N} = a_1, \\ \phi_{c,\nu_1 N+1} &= \dots = \phi_{c,\nu_1 N+\nu_2 N} = a_2, \\ &\dots \\ \phi_{c,\nu_1 N+\dots+\nu_{K-1} N+1} &= \dots = \phi_{c,N} = a_K, \end{aligned} \tag{90}$$

we obtain

$$Z_{(\nu_1, \dots, \nu_K)} = \prod_{I=1}^K Z_{G,\nu_I}, \quad Z_{G,\nu_I} = (\text{sgn}(W''(a_I)))^{\nu_I N}. \tag{91}$$

Z_{G,ν_I} can be interpreted as the partition function of the Gaussian SUSY matrix model with the matrix size $\nu_I N \times \nu_I N$ describing contributions from Gaussian fluctuations around $\phi = a_I$.

3.2 $\alpha \neq 0$ case

In the presence of the external field α , let us consider $\Xi_\alpha(B)$ in (58) with the action (62) obtained after the change of variables (55). Using the explicit form of the measure (59) and (60), we obtain

$$\begin{aligned} \Xi_\alpha(B) &= (e^{i\alpha} - 1) \frac{(-1)^{N^2-1}}{\mathcal{N}_B^2} \int d^{N^2} \tilde{\phi} \left(d^{N^2} \psi d^{N^2} \tilde{\psi} \right) e^{-N \text{tr}[\frac{1}{2} B^2 + i B W'(\tilde{\phi}) + \tilde{\psi} Q W'(\tilde{\phi})]} \\ &\quad \times N \text{tr}(B \tilde{\psi}) N \text{tr}(B \psi) e^{-(e^{i\alpha}-1) N \text{tr}(\tilde{\psi} \psi)}, \end{aligned} \tag{92}$$

which is valid for $B \neq 0$. It does not vanish in general by the effect of the twist $e^{i\alpha} - 1$. This suggests that the localization is incomplete by the twist. Although we can proceed the computation further, it is more convenient to invoke another method based on the Nicolai mapping we will present in the next section.

4. $(e^{i\alpha} - 1)$ -expansion and Nicolai mapping

In the previous section, we have seen that the change of variables is useful to localize the path integral, but in the $\alpha \neq 0$ case the external field makes the localization incomplete and the explicit computation somewhat cumbersome. In this section, we instead compute Z_α^M in an expansion with respect to $(e^{i\alpha} - 1)$. For the purpose of examining the spontaneous SUSY breaking, we are interested in behavior of Z_α^M in the $\alpha \rightarrow 0$ limit. Thus it is expected that it will be often sufficient to compute Z_α^M in the leading order of the $(e^{i\alpha} - 1)$ -expansion for our purpose.

4.1 Finite N

Performing the integration over fermions and the auxiliary field B in (50) with $W'(\phi)$ in (40), we have

$$Z_\alpha^M = \int d^{N^2} \phi \det \left((e^{i\alpha} - 1) \mathbf{1} \otimes \mathbf{1} + \sum_{k=1}^p g_k \sum_{\ell=0}^{k-1} \phi^\ell \otimes \phi^{p-\ell-1} \right) e^{-N \text{tr} \frac{1}{2} W'(\phi)^2}. \tag{93}$$

Hereafter, let us expand this with respect to $(e^{i\alpha} - 1)$ as

$$Z_\alpha^M = \sum_{k=0}^{N^2} (e^{i\alpha} - 1)^k Z_{\alpha,k}, \tag{94}$$

and derive a formula in the leading order of this expansion. The change of variable ϕ as (77) recasts (93) to

$$Z_\alpha^M = \tilde{C}_N \int \left(\prod_{i=1}^N d\lambda_i \right) \Delta(\lambda)^2 \prod_{i,j=1}^N \left(e^{i\alpha} - 1 + \sum_{k=1}^p g_k \sum_{\ell=0}^{k-1} \lambda_i^\ell \lambda_j^{p-\ell-1} \right) e^{-N \sum_{i=1}^N \frac{1}{2} W'(\lambda_i)^2}, \quad (95)$$

after the $SU(N)$ angles are integrated out. Crucial observation is that we can apply the Nicolai mapping (Nicolai, 1979) for each i even in the presence of the external field

$$\Lambda_i = (e^{i\alpha} - 1)\lambda_i + W'(\lambda_i), \quad (96)$$

in terms of which the partition function is basically expressed as an unnormalized expectation value of the Gaussian matrix model

$$Z_\alpha^M = \tilde{C}_N \int \left(\prod_{i=1}^N d\Lambda_i \right) \prod_{i>j} (\Lambda_i - \Lambda_j)^2 e^{-N \sum_i \frac{1}{2} \Lambda_i^2} e^{-N \sum_i (-A\Lambda_i \lambda_i + \frac{1}{2} A^2 \lambda_i^2)}, \quad (97)$$

where $A = e^{i\alpha} - 1$. However, there is an important difference from the Gaussian matrix model, which originates from the fact that the Nicolai mapping (96) is not one to one. As a consequence, λ_i has several branches as a function of Λ_i and it has a different expression according to each of the branches. Therefore, since the last factor of (97) contains $\lambda_i(\Lambda_i)$, we have to take account of the branches and divide the integration region of Λ_i accordingly. Nevertheless, we can derive a rather simple formula at least in the leading order of the expansion in terms of A owing to the Nicolai mapping (96). In the following, let us concentrate on the cases where

$$\Lambda_i \rightarrow \infty \text{ as } \lambda_i \rightarrow \pm\infty, \quad \text{or} \quad \Lambda_i \rightarrow -\infty \text{ as } \lambda_i \rightarrow \pm\infty, \quad (98)$$

i.e. the leading order of $W'(\phi)$ is even. In such cases, we can expect spontaneous SUSY breaking, in which the leading nontrivial expansion coefficient is relevant since the zeroth order partition function vanishes: $Z_{\alpha=0}^M = Z_{\alpha,0} = 0$. Namely, in the expansion of the last factor in (97)

$$e^{-N \sum_{i=1}^N (-A\Lambda_i \lambda_i + \frac{1}{2} A^2 \lambda_i^2)} = 1 - N \sum_{i=1}^N \left(-A\Lambda_i \lambda_i + \frac{1}{2} A^2 \lambda_i^2 \right) + \dots, \quad (99)$$

the first term "1" does not contribute to Z_α^M . It can be understood from the fact that it does not depend on the branches and thus the Nicolai mapping becomes trivial, i.e. The mapping degree is zero. Notice that the second term also gives a vanishing effect. For each i , we have the unnormalized expectation value of $N \left(A\Lambda_i \lambda_i - \frac{1}{2} A^2 \lambda_i^2 \right)$, where the Λ_j -integrals ($j \neq i$) are independent of the branches leading to the trivial Nicolai mapping. Thus, in order to get a nonvanishing result, we need a branch-dependent piece in the integrand for any Λ_i . This immediately shows that in the expansion (94), $Z_{\alpha,k} = 0$ for $k = 0, \dots, N-1$ and that the first possibly nonvanishing contribution starts from $\mathcal{O}(A^N)$ as

$$Z_{\alpha,N} = \tilde{C}_N N^N \int \left(\prod_{i=1}^N d\Lambda_i \right) \prod_{i>j} (\Lambda_i - \Lambda_j)^2 e^{-N \sum_{i=1}^N \frac{1}{2} \Lambda_i^2} \prod_{i=1}^N (\Lambda_i \lambda_i) \Bigg|_{A=0}. \quad (100)$$

Note that the $A(= e^{i\alpha} - 1)$ -dependence of the integrand comes also from λ_i as a function of Λ_i through (96). Although the integration over Λ_i above should be divided into the branches, if we change the integration variables so that we will recover the original λ_i with $A = 0$ (which we call x_i) by

$$\Lambda_i = W'(x_i), \tag{101}$$

then by construction the integration of x_i is standard and runs from $-\infty$ to ∞ . Therefore, we arrive at

$$Z_{\alpha,N} = \tilde{C}_N N^N \int_{-\infty}^{\infty} \left(\prod_{i=1}^N dx_i \right) \prod_{i=1}^N (W''(x_i)W'(x_i)x_i) \prod_{i>j} (W'(x_i) - W'(x_j))^2 \times e^{-N \sum_{i=1}^N \frac{1}{2} W'(x_i)^2}, \tag{102}$$

which does not vanish in general. For example, taking $W'(\phi) = g(\phi^2 - \mu^2)$ we have for $N = 2$

$$Z_{\alpha,2} = 10g^2 \tilde{C}_2 I_0^2 \left[\frac{I_4}{I_0} - \frac{9}{5} \left(\frac{I_2}{I_0} \right)^2 \right], \tag{103}$$

where

$$I_n \equiv \int_{-\infty}^{\infty} d\lambda \lambda^n e^{-g^2(\lambda^2 - \mu^2)^2} \quad (n = 0, 2, 4, \dots). \tag{104}$$

In fact, when $g = 1, \mu^2 = 1$ (double-well scalar potential case) we find

$$I_0 = 1.97373, \quad \frac{I_4}{I_0} - \frac{9}{5} \left(\frac{I_2}{I_0} \right)^2 = -0.165492 \neq 0, \tag{105}$$

hence $Z_{\alpha,2}$ actually does not vanish. In the case of the discretized SUSY quantum mechanics, we have seen in (35) that the expansion of Z_{α}^M with respect to $(e^{i\alpha} - 1)$ terminates at the linear order for any T . Thus, the nontrivial $\mathcal{O}(A^N)$ contribution of higher order can be regarded as a specific feature of SUSY matrix models.

We stress here that, although we have expanded the partition function in terms of $(e^{i\alpha} - 1)$ and (102) is the leading order one, it is an exact result of the partition function for any finite N and any polynomial $W'(\phi)$ of even degree in the presence of the external field. Thus, it provides a firm ground for discussion of spontaneous SUSY breaking in various settings.

4.2 Large- N

As an application of (102), let us discuss SUSY breaking/restoration in the large- N limit of our SUSY matrix models. From (102), introducing the eigenvalue density

$$\rho(x) = \frac{1}{N} \sum_{i=1}^N \delta(x - x_i) \tag{106}$$

rewrites the leading $\mathcal{O}(A^N)$ part of Z_{α}^M as

$$Z_{\alpha,N} = N^N \int \left(\prod_{i=1}^N dx_i \right) \exp(-N^2 F), \tag{107}$$

$$F \equiv - \int dx dy \rho(x)\rho(y) \log |W'(x) - W'(y)| + \int dx \rho(x) \frac{1}{2} W'(x)^2 - \frac{1}{N^2} \log \tilde{C}_N - \frac{1}{N} \int dx \rho(x) \log(W''(x)W'(x)x). \tag{108}$$

In the large- N limit, $\rho(x)$ is given as a solution to the saddle point equation obtained from $\mathcal{O}(N^0)$ part of F as

$$0 = \int dy \rho(y) \frac{W''(x)}{|W'(x) - W'(y)|} - \frac{1}{2} W'(x) W''(x). \quad (109)$$

Plugging a solution $\rho_0(x)$ into F in (108), we get Z_{α}^M in the large- N limit in the leading order of $(e^{i\alpha} - 1)$ -expansion as

$$\begin{aligned} Z_{\alpha, N} &\rightarrow N^N \exp(-N^2 F_0), \\ F_0 &= - \int dx dy \rho_0(x) \rho_0(y) \log |W'(x) - W'(y)| + \int dx \rho_0(x) \frac{1}{2} W'(x)^2 \\ &\quad - \frac{1}{N^2} \log C_N, \end{aligned} \quad (110)$$

where C_N is a factor dependent only on N which arises in replacing the integration over ϕ by the saddle point of its eigenvalue density, thus including \tilde{C}_N . From consideration of the Gaussian matrix model (85), C_N is calculated in appendix B in ref. (Kuroki & Sugino, 2010) as

$$C_N = \exp \left[\frac{3}{4} N^2 + \mathcal{O}(N^0) \right]. \quad (111)$$

In (110) we notice that, if we include $\mathcal{O}(1/N)$ part of F (the last term in (108)) in deriving the saddle point equation, the solution will receive an $\mathcal{O}(1/N)$ correction as $\rho(x) = \rho_0(x) + \frac{1}{N} \rho_1(x)$. However, when we substitute this into (108), $\rho_1(x)$ will contribute to F only by the order $\mathcal{O}(1/N^2)$, because $\mathcal{O}(1/N)$ corrections to F_0 under $\rho_0(x) \rightarrow \rho_0(x) + \frac{1}{N} \rho_1(x)$ vanish as a result of the saddle point equation at the leading order (109) satisfied by $\rho_0(x)$.

4.3 Example: SUSY matrix model with double-well potential

For illustration of results in the previous subsection, let us consider the SUSY matrix model with $W(\phi) = \phi^2 - \mu^2$. The saddle point equation (109) becomes

$$\int dy \frac{\rho(y)}{x-y} + \int dy \frac{\rho(y)}{x+y} = x^3 - \mu^2 x. \quad (112)$$

Let us consider the case $\mu^2 > 0$, where the shape of the scalar potential is a double-well $\frac{1}{2} (x^2 - \mu^2)^2$.

4.3.1 Asymmetric one-cut solution

First, we find a solution corresponding to all the eigenvalues located around one of the minima $\lambda = +\sqrt{\mu^2}$. Assuming the support of $\rho(x)$ as $x \in [a, b]$ with $0 < a < b$, the equation (112) is valid for $x \in [a, b]$.

Following the method in ref. (Brezin et al., 1978), we introduce a holomorphic function

$$F(z) \equiv \int_a^b dy \frac{\rho(y)}{z-y}, \quad (113)$$

which satisfies the following properties:

1. $F(z)$ is analytic in $z \in \mathbf{C}$ except the cut $[a, b]$.

2. $F(z)$ is real on $z \in \mathbf{R}$ outside the cut.
3. For $z \sim \infty$,

$$F(z) = \frac{1}{z} + \mathcal{O}\left(\frac{1}{z^2}\right).$$
4. For $x \in [a, b]$,

$$F(x \pm i0) = F(-x) + x^3 - \mu^2 x \mp i\pi\rho(x).$$

Note that, if we consider the combination (Eynard & Kristjansen, 1995)

$$F_-(z) \equiv \frac{1}{2}(F(z) - F(-z)), \quad (114)$$

then the properties of $F_-(z)$ are

1. $F_-(z)$ is analytic in $z \in \mathbf{C}$ except the two cuts $[a, b]$ and $[-b, -a]$.
2. $F_-(z)$ is odd ($F_-(-z) = -F_-(z)$), and real on $z \in \mathbf{R}$ outside the cuts.
3. For $z \sim \infty$,

$$F_-(z) = \frac{1}{z} + \mathcal{O}\left(\frac{1}{z^3}\right).$$
4. For $x \in [a, b]$,

$$F_-(x \pm i0) = \frac{1}{2}(x^3 - \mu^2 x) \mp i\frac{\pi}{2}\rho(x).$$

These properties are sufficient to fix the form of $F_-(z)$ as

$$F_-(z) = \frac{1}{2}(z^3 - \mu^2 z) - \frac{1}{2}z\sqrt{(z^2 - a^2)(z^2 - b^2)} \quad (115)$$

with

$$a^2 = -2 + \mu^2, \quad b^2 = 2 + \mu^2. \quad (116)$$

Since a^2 should be positive, the solution is valid for $\mu^2 > 2$. The eigenvalue distribution is obtained as

$$\rho_0(x) = \frac{x}{\pi} \sqrt{(x^2 - a^2)(b^2 - x^2)}. \quad (117)$$

From (117), we see that

$$\lim_{\alpha \rightarrow 0} \left(\lim_{N \rightarrow \infty} \left\langle \frac{1}{N} \text{tr} \phi \right\rangle_\alpha \right) = \int_a^b dx x \rho_0(x) \quad (118)$$

is finite and nonsingular, differently from the situation in (19). It can be understood that the tunneling between separate broken vacua is suppressed by taking the large- N limit, and thus the superselection rule works. Note that the large- N limit in the matrix models is analogous to the infinite volume limit or the thermodynamic limit of statistical systems. In fact, this will play an essential role for restoration of SUSY in the large- N limit of the matrix model with a double-well potential.

Using (117), we compute the expectation value of $\frac{1}{N} \text{tr} B$ as

$$\lim_{\alpha \rightarrow 0} \left(\lim_{N \rightarrow \infty} \left\langle \frac{1}{N} \text{tr} B \right\rangle_\alpha \right) = \int_a^b dx (x^2 - \mu^2) \rho_0(x) = 0. \quad (119)$$

Furthermore, all the expectation values of $\frac{1}{N} \text{tr} B^n$ are proven to vanish:

$$\lim_{\alpha \rightarrow 0} \left(\lim_{N \rightarrow \infty} \left\langle \frac{1}{N} \text{tr} B^n \right\rangle_\alpha \right) = 0 \quad (n = 1, 2, \dots). \quad (120)$$

(For a proof, see appendix C in ref. (Kuroki & Sugino, 2010).) Also, the large- N free energy (110) vanishes. These evidences convince us that the SUSY is restored at infinite N .

4.3.2 Two-cut solutions

Let us consider configurations that $\nu_+ N$ eigenvalues are located around one minimum $\lambda = +\sqrt{\mu^2}$ of the double-well, and the remaining $\nu_- N (= N - \nu_+ N)$ eigenvalues are around the other minimum $\lambda = -\sqrt{\mu^2}$.

First, we focus on the Z_2 -symmetric two-cut solution with $\nu_+ = \nu_- = \frac{1}{2}$, where the eigenvalue distribution is supposed to have a Z_2 -symmetric support $\Omega = [-b, -a] \cup [a, b]$, and $\rho(-x) = \rho(x)$. The equation (112) is valid for $x \in \Omega$. Due to the Z_2 symmetry, the holomorphic function $F(z) \equiv \int_{\Omega} dy \frac{\rho(y)}{z-y}$ has the same properties as $F_-(z)$ in section 4.3.1 except the property 4, which is now changed to

$$F(x \pm i0) = \frac{1}{2} (x^3 - \mu^2 x) \mp i\pi\rho(x) \quad \text{for } x \in \Omega. \tag{121}$$

The solution is given by

$$F(z) = \frac{1}{2} (z^3 - \mu^2 z) - \frac{1}{2} z \sqrt{(z^2 - a^2)(z^2 - b^2)}, \tag{122}$$

$$\rho_0(x) = \frac{1}{2\pi} |x| \sqrt{(x^2 - a^2)(b^2 - x^2)}, \tag{123}$$

where a, b coincide with the values of the one-cut solution (116). It is easy to see that, concerning Z_2 -symmetric observables, the expectation values are the same as the expectation values evaluated under the one-cut solution. In particular, we have the same conclusion for the expectation values of $\frac{1}{N} \text{tr} B^n$ and the large- N free energy vanishing.

It is somewhat surprising that the end points of the cut a, b and the large- N free energy coincide with those for the one-cut solution, which is recognized as a new interesting feature of the supersymmetric models and can be never seen in the case of bosonic double-well matrix models. In bosonic double-well matrix models, the free energy of the Z_2 -symmetric two-cut solution is lower than that of the one-cut solution, and the endpoints of the cuts are different between the two solutions (Cicuti et al., 1986; Nishimura et al., 2003).

Next, let us consider general Z_2 -asymmetric two-cut solutions (i.e., general ν_{\pm}). We can check that the following solution gives a large- N saddle point:

The eigenvalue distribution $\rho_0(x)$ has the cut $\Omega = [-b, -a] \cup [a, b]$ with a, b given by (116):

$$\rho_0(x) = \begin{cases} \frac{\nu_+}{\pi} x \sqrt{(x^2 - a^2)(b^2 - x^2)} & (a < x < b) \\ \frac{\nu_-}{\pi} |x| \sqrt{(x^2 - a^2)(b^2 - x^2)} & (-b < x < -a). \end{cases} \tag{124}$$

This is a general supersymmetric solution including the one-cut and Z_2 -symmetric two-cut solutions. The expectation values of Z_2 -even observables under this saddle point coincide with those under the one-cut solution, and the expectation values of $\frac{1}{N} \text{tr} B^n$ and the large- N free energy vanish, again. Thus, we can conclude that the SUSY matrix model with the double-well potential has an infinitely many degenerate supersymmetric saddle points parametrized by (ν_+, ν_-) at large N for the case $\mu^2 > 2$.

4.3.3 Symmetric one-cut solution

Here we obtain a one-cut solution with a symmetric support $[-c, c]$. As before, let us consider a complex function

$$G(z) \equiv \int_{-c}^c dy \frac{\rho(y)}{z-y}, \tag{125}$$

and further define

$$G_-(z) \equiv \frac{1}{2}(G(z) - G(-z)). \quad (126)$$

Then $G_-(z)$ has following properties:

1. $G_-(z)$ is odd, analytic in $z \in \mathbf{C}$ except the cut $[-c, c]$.
2. $G_-(x) \in \mathbf{R}$ for $x \in \mathbf{R}$ and $x \notin [-c, c]$.
3. $G_-(z) \rightarrow \frac{1}{z} + \mathcal{O}(\frac{1}{z^3})$ as $z \rightarrow \infty$.
4. $G_-(x \pm i0) = \frac{1}{2}(x^2 - \mu^2)x \mp i\pi\rho(x)$ for $x \in [-c, c]$.

They lead us to deduce

$$G_-(z) = \frac{1}{2}(z^2 - \mu^2)z - \frac{1}{2}\left(z^2 - \mu^2 + \frac{c^2}{2}\right)\sqrt{z^2 - c^2} \quad (127)$$

with

$$c^2 = \frac{2}{3}\left(\mu^2 + \sqrt{\mu^4 + 12}\right), \quad (128)$$

from which we find that

$$\rho_0(x) = \frac{1}{2\pi}\left(x^2 - \mu^2 + \frac{c^2}{2}\right)\sqrt{c^2 - x^2}, \quad x \in [-c, c]. \quad (129)$$

The condition $\rho_0(x) \geq 0$ tells us that this solution is valid for $\mu^2 \leq 2$, which is indeed the complement of the region of μ^2 where both the two-cut solution and the asymmetric one-cut solution exist. (129) is valid also for $\mu^2 < 0$. Given $\rho_0(x)$, it is straightforward to calculate the large- N free energy as

$$F_0 = \frac{1}{3}\mu^4 - \frac{1}{216}\mu^8 - \frac{1}{216}(\mu^6 + 30\mu^2)\sqrt{\mu^4 + 12} - \log(\mu^2 + \sqrt{\mu^4 + 12}) + \log 6, \quad (130)$$

which is positive for $\mu^2 < 2$. Also, the expectation value of $\frac{1}{N} \text{tr} B$ is computed to be

$$\left\langle \frac{1}{N} \text{tr} B \right\rangle = -i \left[\frac{c^4}{16}(c^2 - \mu^2) - \mu^2 \right] \neq 0 \quad \text{for } \mu^2 < 2. \quad (131)$$

These are strong evidence suggesting the spontaneous SUSY breaking. Also, the μ^2 -derivatives of the free energy,

$$\lim_{\mu^2 \rightarrow 2-0} F_0 = \lim_{\mu^2 \rightarrow 2-0} \frac{dF_0}{d(\mu^2)} = \lim_{\mu^2 \rightarrow 2-0} \frac{d^2F_0}{d(\mu^2)^2} = 0, \quad \lim_{\mu^2 \rightarrow 2-0} \frac{d^3F_0}{d(\mu^2)^3} = -\frac{1}{2}, \quad (132)$$

show that the transition between the SUSY phase ($\mu^2 \geq 2$) and the SUSY broken phase ($\mu^2 < 2$) is of the third order.

5. Summary and discussion

In this chapter, firstly we discussed spontaneous SUSY breaking in the (discretized) quantum mechanics. The twist α , playing a role of the external field, was introduced to detect the SUSY breaking, as well as to regularize the supersymmetric partition function (essentially equivalent to the Witten index) which becomes zero when the SUSY is broken. Differently from spontaneous breaking of ordinary (bosonic) symmetry, SUSY breaking does not require cooperative phenomena and can take place even in the discretized quantum mechanics with a finite number of discretized time steps. There is such a possibility, when the supersymmetric partition function vanishes. In general, some non-analytic behavior is necessary for spontaneous symmetry breaking to take place. For SUSY breaking in the finite system, it can be understood that the non-analyticity comes from the vanishing partition function.

Secondly we discussed localization in SUSY matrix models without the external field. The formula of the partition function was obtained, which is given by the N -th power of the localization formula in the $N = 1$ case (N is the rank of matrix variables). It can be regarded as a matrix-model generalization of the ordinary localization formula. In terms of eigenvalues, localization attracts them to the critical points of superpotential, while the square of the Vandermonde determinant originating from the measure factor gives repulsive force among them. Thus, the dynamics of the eigenvalues is governed by balance of the attractive force from the localization and the repulsive force from the Vandermonde determinant. It is a new feature specific to SUSY matrix models, not seen in the (discretized) SUSY quantum mechanics. For a general superpotential which has K critical points, contribution to the partition function from $\nu_I N$ eigenvalues fluctuating around the I -th critical point ($I = 1, \dots, K$), denoted by $Z_{(\nu_1, \dots, \nu_K)}$, was shown to be equal to the products of the partition functions of the Gaussian SUSY matrix models $Z_{G, \nu_1} \cdots Z_{G, \nu_K}$. Here, Z_{G, ν_I} is the partition function of the Gaussian SUSY matrix model with the rank of matrix variables being $\nu_I N$, which describes Gaussian fluctuations around the I -th critical point. It is interesting to investigate whether such a factorization occurs also for various expectation values.

Thirdly, the argument of the change of variables leading to localization can be applied to $\alpha \neq 0$ case. Then, we found that α -dependent terms in the action explicitly break SUSY and makes localization incomplete. Instead of it, the Nicolai mapping, which is also applicable to the $\alpha \neq 0$ case, is more convenient for actual calculation in SUSY matrix models. In the case that the supersymmetric partition function (the partition function with $\alpha = 0$) vanishes, we obtained an exact result of a leading nontrivial contribution to the partition function with $\alpha \neq 0$ in the expansion of $(e^{i\alpha} - 1)$ for finite N . It will play a crucial role to compute various correlators when SUSY is spontaneously broken. Large- N solutions for the double-well case $W^l(\phi) = \phi^2 - \mu^2$ were derived, and it was found that there is a phase transition between the SUSY phase corresponding to $\mu^2 \geq 2$ and the SUSY broken phase to $\mu^2 < 2$. It was shown to be of the third order.

For future directions, this kind of argument can be expected to be useful to investigate localization in various lattice models for supersymmetric field theories which realize some SUSYs on the lattice. Also, it will be interesting to investigate localization in models constructed in ref. (Kuroki & Sugino, 2008), which couple a supersymmetric quantum field theory to a certain large- N matrix model and cause spontaneous SUSY breaking at large N .

Finally, we hope that similar analysis for super Yang-Mills matrix models (Banks et al., 1997; Dijkgraaf et al., 1997; Ishibashi et al., 1997), which have been proposed as nonperturbative

definitions of superstring/M theories, will shed light on new aspects of spontaneous SUSY breaking in superstring/M theories.

6. Acknowledgements

The author would like to thank Tsunehide Kuroki for collaboration which gives a basis for main contribution to this chapter.

7. References

- Banks, T.; Fischler, W.; Shenker, S. H. & Susskind, L. (1996). M theory as a matrix model: A conjecture, *Physical Review D* 55: 5112-5128.
- Brezin, E.; Itzykson, C.; Parisi, G. & Zuber, J. B. (1978). Planar Diagrams, *Communications in Mathematical Physics* 59 : 35-51.
- Catterall, S. (2003). Lattice supersymmetry and topological field theory, *Journal of High Energy Physics* 0305: 038.
- Cicuti, G. M.; Molinari, L. & Montaldi, E. (1986). Large N Phase Transitions In Low Dimensions, *Modern Physics Letters A* 1: 125-129.
- Coleman, S. R. (1973). There are no Goldstone bosons in two-dimensions, *Communications in Mathematical Physics* 31: 259-264.
- Dijkgraaf, R.; Verlinde, E. P. & Verlinde, H. L. (1997). Matrix string theory, *Nuclear Physics B* 500: 43-61.
- Eynard, B. & Kristjansen, C. (1995). Exact Solution of the $O(n)$ Model on a Random Lattice, *Nuclear Physics B* 455: 577-618.
- Ishibashi, N.; Kawai, H.; Kitazawa, Y. & Tsuchiya, A. (1996). A large- N reduced model as superstring, *Nuclear Physics B* 498: 467-491.
- Kanamori, I.; Suzuki, H. & Sugino, F. (2008). Euclidean lattice simulation for the dynamical supersymmetry breaking, *Physical Review D* 77: 091502.
- Kanamori, I.; Suzuki, H. & Sugino, F. (2008). Observing dynamical supersymmetry breaking with euclidean lattice simulations, *Progress of Theoretical Physics* 119: 797-827.
- Kuroki, T. & Sugino, F. (2008). Spontaneous Supersymmetry Breaking by Large- N Matrices, *Nuclear Physics B* 796: 471-499.
- Kuroki, T. & Sugino, F. (2010). Spontaneous supersymmetry breaking in large- N matrix models with slowly varying potential, *Nuclear Physics B* 830: 434-473.
- Kuroki, T. & Sugino, F. (2011). Spontaneous supersymmetry breaking in matrix models from the viewpoints of localization and Nicolai mapping," *Nuclear Physics B* 844: 409-449.
- Mermin, N. D. & Wagner, H. (1966). Absence of ferromagnetism or antiferromagnetism in one-dimensional or two-dimensional isotropic Heisenberg models, *Physical Review Letters* 17: 1133-1136.
- Nicolai, H. (1979). On A New Characterization Of Scalar Supersymmetric Theories, *Physics Letters B* 89: 341-346.
- Nishimura, J.; Okubo, T. & Sugino, F. (2003). Testing the Gaussian expansion method in exactly solvable matrix models, *Journal of High Energy Physics* 0310: 057.
- Sohnius, M. F. (1985). Introducing Supersymmetry, *Physics Reports* 128: 39-204.
- Witten, E. (1981). Dynamical Breaking Of Supersymmetry, *Nuclear Physics B* 188: 513-554.
- Witten, E. (1982). Constraints On Supersymmetry Breaking, *Nuclear Physics B* 202: 253-316.

Correspondences of Scale Relativity Theory with Quantum Mechanics

Călin Gh. Buzea¹, Maricel Agop² and Carmen Nejneru³

¹*National Institute of Research and Development for Technical Physics*

²*Department of Physics, Technical "Gh. Asachi" University*

³*Materials and Engineering Science, Technical "Gh. Asachi" University
Romania*

1. Introduction

We perform a critical analysis of some quantum mechanical models such as the hydrodynamic model (Madelung's model), de Broglie's theory of double solution etc., specifying both mathematical and physical inconsistencies that occur in their construction.

These inconsistencies are eliminated by means of the fractal approximation of motion (physical objects moving on continuous and non-differentiable curves, i.e. fractal curves) developed in the framework of Scale Relativity (SR) (Nottale, L., 1993; Chaline, J. et al, 2009; Chaline, J. et al, 2000; Nottale, L., 2004; Nottale, L. & Schneider J., 1984; Nottale, L., 1989; Nottale, L., 1996). The following original results are obtained: i) separation of the physical motion of objects in wave and particle components depending on the scale of resolution (differentiable as waves and non-differentiable as particles) - see paragraphs 5-7; ii) solidar motion of the wave and particle (wave-particle duality) - see paragraph 8, the mechanisms of duality (in phase wave-particle coherence, paragraphs 9 and 10 and wave-particle incoherence, see paragraph 11); iii) the particle as a clock, its incorporation into the wave and the implications of such a process - see paragraphs 12 and 13; iv) Lorentz-type mechanisms of wave-particle duality - see paragraph 14.

The original results of this work are published in references (Harabagiu A. et al , 2010; Agop, M. et al, 2008; Harabagiu, A. & Agop, M., 2005; Harabagiu, A. et al, 2009; Agop, M. et al, 2008). Explicitely, Eulerian's approximation of motions on fractal curves is presented in (Agop, M. et al, 2008), the hydrodynamic model in a second order approximation of motion in (Harabagiu, A. & Agop, M., 2005), wave-particle duality for „coherent" fractal fluids with the explanation of the potential gap in (Harabagiu, A. et al, 2009), the physical self-consistence of wave-particle duality in various approximations of motion and for various fractal curves in (Agop, M. et al, 2008). A unitary treatment of both the problems listed above and their various mathematical and physical extensions are developed in (Harabagiu A. et al , 2010).

2. Hydrodynamic model of quantum mechanics (Madelung's model)

Quantum mechanics is substantiated by the Schrödinger wave equation (Țițeica, S., 1984; Felsager, B., 1981; Peres, A., 1993; Sakurai J.J. & San Fu Taun, 1994)

$$i\hbar \frac{\partial \Psi}{\partial t} = U\Psi - \frac{\hbar^2}{2m_0} \Delta \Psi \quad (1)$$

where \hbar is the reduced Planck's constant, m_0 the rest mass of the test particle, U the external scalar field and Ψ the wave-function associated to the physical system. This differential equation is linear and complex.

Starting from this equation, Madelung (Halbwachs, F., 1960; Madelung R., 1927) constructed the following model. One separates real and imaginary parts by choosing Ψ of the form:

$$\Psi(\mathbf{r}, t) = R(\mathbf{r}, t) e^{iS(\mathbf{r}, t)} \quad (2)$$

which induces the velocity field:

$$\mathbf{v} = \frac{\hbar}{m_0} \nabla S \quad (3)$$

and the density of the probability field:

$$\rho(\mathbf{r}, t) = R^2(\mathbf{r}, t) \quad (4)$$

Using these fields one gets the hydrodynamic version of quantum mechanics (Madelung's model)

$$\frac{\partial}{\partial t}(m_0 \rho \mathbf{v}) + \nabla(m_0 \rho \mathbf{v} \mathbf{v}) = -\rho \nabla(U + Q) \quad (5)$$

$$\frac{\partial \rho}{\partial t} + \nabla \cdot (\rho \mathbf{v}) = 0 \quad (6)$$

where

$$Q = -\frac{\hbar^2}{2m_0} \frac{\Delta \sqrt{\rho}}{\sqrt{\rho}} \quad (7)$$

is called the quantum potential. Equation (5) corresponds to the momentum conservation law and equation (6) to the conservation law of the probability's density field (quantum hydrodynamics equations).

We have the following: i) any micro-particle is in constant interaction with an environment called „subquantic medium“ through the quantum potential Q , ii) the „subquantic medium“ is identified with a nonrelativistic quantum fluid described by the equations of quantum hydrodynamics. In other words, the propagation of the Ψ field from wave mechanics is replaced by a fictitious fluid flow having the density ρ and the speed \mathbf{v} , the fluid being in a field of forces $\nabla(U + Q)$. Moreover, the following model of particle states (Bohm D. & Hiley B.J., 1993; Dörr D. et al, 1992; Holland P.R., 1993; Albert D.Z., 1994; Berndl K. et al, 1993; Berndl K. et al, 1994; Bell J.S., 1987; Dörr D. et al, 1993): Madelung type fluid in „interaction“ with its own „shell“ (there is no space limitation of the fluid, though of the particle).

3. DeBroglie's theory of double solution. The need for introducing the model of Bohm and Vigier

One of the key observations that de Broglie left in the development of quantum mechanics, is the difference between the relativistic transformation of the frequency of a wave and that of a clock's frequency (de Broglie L., 1956; de Broglie L., 1957; de Broglie L., 1959; de Broglie L., 1963; de Broglie L., 1964; de Broglie L., 1980). It is well known that, if ν_0 is the frequency of a clock in its own framework, the frequency conferred by an observer who sees it passing with the speed $v = \beta c$ is

$$\nu_c = \nu_0 \sqrt{1 - \beta^2} .$$

This is what is called the phenomenon of "slowing down of horologes". This phenomenon takes place due to the relative motion of horologes. On the contrary, if a wave within a certain reference system is a stationary one, with frequency ν_0 and is noticed in a reference system animated with speed $v = \beta c$, as compared with the first one, it will appear as a progressive wave that propagates in the sense of the relative motion, with frequency

$$\nu = \frac{\nu_0}{\sqrt{1 - \beta^2}}$$

and with the phase speed

$$V = \frac{c}{\beta} = \frac{c^2}{v} .$$

If the corpuscle, according to relation $W = h\nu$, is given an internal frequency

$$\nu_0 = \frac{m_0 c^2}{h}$$

and if we admit that within the appropriate system of the corpuscle the associated wave is a stationary one, with frequency ν_0 , all the fundamental relations of undulatory mechanics

and in particular $\lambda = \frac{h}{p}$, in which p is the impulse of the corpuscle, are immediately

obtained from the previous relations.

Since de Broglie considers that the corpuscle is constantly located in the wave, he notices the following consequence: the motion of the corpuscle has such a nature that it ensures the permanent concordance between the phase of the surrounding wave and the internal phase of the corpuscle considered as a small horologe. This relation can be immediately verified in the simple case of a corpuscle in uniform motion, accompanied by a monochromatic plain wave. Thus, when the wave has the general form

$$\Psi = A(x, y, z, t) e^{\frac{2\pi i}{h} \Phi(x, y, z, t)}$$

in which A and Φ are real, the phase concordance between the corpuscle and its wave requires that the speed of the corpuscle in each point of its trajectory be given by the relation

$$\mathbf{v} = -\frac{1}{m_0} \nabla \Phi$$

Nevertheless it was not enough to superpose the corpuscle with the wave, imposing it to be guided by the propagation of the wave: the corpuscle had to be represented as being incorporated in the wave, i.e. as being a part of the structure of the wave. De Broglie was thus directed to what he himself called the theory of “double solution”. This theory admits that the real wave is not a homogeneous one, that it has a very small area of high concentration of the field that represents the corpuscle and that, besides this very small area, the wave appreciably coincides with the homogeneous wave as formulated by the usual undulatory mechanics.

The phenomenon of guiding the particle by the surrounding undulatory field results from the fact that the equations of the field are not linear ones and that this lack of linearity, that almost exclusively shows itself in the corpuscular area, solidarizes the motion of the particle with the propagation of the surrounding wave (de Broglie L., 1963; de Broglie L., 1964; de Broglie L., 1980).

Nevertheless there is a consequence of “guidance” upon which we should insist. Even if a particle is not submitted to any external field, if the wave that surrounds it is not an appreciably plain and monochromatic one (therefore if this wave has to be represented through a superposition of monochromatic plain waves) the motion that the guidance formula imposes is not rectilinear and uniform. The corpuscle is subjected by the surrounding wave, to a force that curves its trajectory: this “quantum force” equals the gradient with the changed sign of the quantum potential Q given by (7). Therefore, the uniform motion of the wave has to be superposed with a “Brownian” motion having random character that is specific to the corpuscle.

Under the influence of Q , the corpuscle, instead of uniformly following one of the trajectories that are defined by the guidance law, constantly jumps from one of these trajectories to another, thus passing in a very short period of time, a considerably big number of sections within these trajectories and, while the wave remains isolated in a finite area of the space, this zigzag trajectory hurries to explore completely all this region. In this manner, one can justify that the probability of the particle to be present in a volume element dr of the physical space is equal to $|\Psi|^2 dr$. This is what Bohm and Vigier did in their statement: therefore they showed that the probability of repartition in $|\Psi|^2$ must take place very quickly. The success of this demonstration must be correlated with the characteristics of “Markov’s chains.” (Bohm, D., 1952; Bohm D. & Hiley B.J., 1993; Bohm D., 1952; Bohm D., 1953).

4. Comments

In his attempt to build the theory of the double solution, de Broglie admits certain assertions (de Broglie L., 1956; de Broglie L., 1957; de Broglie L., 1959; de Broglie L., 1963; de Broglie L., 1964; de Broglie L., 1980):

- i. the frequency of the corpuscle that is assimilated to a small horologe must be identified with the frequency of the associated progressive wave;
- ii. the coherence of the inner phase of the corpuscle-horologe with the phase of the associated wave;
- iii. the corpuscle must be “incorporated” into the progressive associated wave through the “singularity” state. Thus, the motion of the corpuscle “solidarizes” with the propagation of the associated progressive wave. Nevertheless, once we admit these statements, de Broglie’s theory does not answer a series of problems, such as, for example:

1. What are the mechanisms through which either the undulatory feature or the corpuscular one impose, either both of them in the stationary case as well as in the non stationary one?;
 2. The limits in the wave-corpucle system of the corpuscular component as well as the undulatory one and their correspondence;
 3. How is the "solidarity" between the motion of the corpucle and the one of the associated progressive wave naturally induced?
- iv. What are the consequences of this "solidarity"? And we could continue Moreover, Madelung's theory (Halbwacs, F., 1960; Madelung R., 1927) brings new problems. How can we built a pattern of a corpucle (framework + Madelung liquid) endlessly extended in space?

Here are some of the "drawbacks" of the patterns in paragraphs 2 and 3 which we shall analyze and remove by means of introducing the fractal approximation of the motion.

5. The motion equation of the physical object in the fractal approximation of motion. The Eulerian separation of motion on resolution scales

The fractal approximation of motion refers to the movement of physical objects (wave + corpucle) on continuous and non differentiable curves (fractal curves). This approximation is based on the scale Relativity theory (RS) (Nottalle, L., 1993; Chaline, J. et al, 2009; Chaline, J. et al, 2000; Nottalle, L., 2004, Nottalle, L. & Schneider J., 1984; Nottalle, L., 1989; Nottalle, L., 1996). Thus, the fractal differential operator can be introduced

$$\frac{\hat{d}}{dt} = \frac{\partial}{\partial t} + \hat{\mathbf{V}} \cdot \nabla - i \frac{\lambda^2}{2\tau} \left(\frac{dt}{\tau} \right)^{(2/D_F)-1} \quad (8)$$

where $\hat{\mathbf{V}}$ is the complex speed field

$$\hat{\mathbf{V}} = \mathbf{v} - i\mathbf{u} \quad (9)$$

λ is the scale length, dt is the temporary resolution scale, τ is the specific time to fractal-non fractal transition, and D_F is the arbitrary and constant fractal dimension. Regarding the fractal dimension, we can use any of Hausdorff-Bezicovici, Minkowski-Bouligand or Kolmogoroff dimensions, etc. (Budei, L., 2000; Barnsley, M., 1988; Le Mehante A., 1990; Heck, A. & Perdang, J.M., 1991; Feder, J. & Aharony, A., 1990; Berge, P. et al, 1984; Gouyet J.F., 1992; El Naschie, M.S. et al, 1995; Weibel, P. et al, 2005; Nelson, E., 1985; Nottalle, L., 1993; Chaline, J. et al, 2009; Chaline, J. et al, 2000; Nottalle, L., 2004; Agop, M. et al, 2009). The only restriction refers to the maintaining of the same type of fractal dimension during the dynamic analysis. The real part of the speed field V is differentiable and independent as compared with the resolution scale, while the imaginary scale U is non differentiable (fractal) and depends on the resolution scale.

Now we can apply the principle of scale covariance by substituting the standard time derivate (d/dt) with the complex operator \hat{d}/dt . Accordingly, the equation of fractal space-time geodesics (the motion equation in second order approximation, where second order derivates are used) in a covariant form:

$$\frac{d\hat{\mathbf{V}}}{dt} = \frac{\partial\hat{\mathbf{V}}}{\partial t} + \hat{\mathbf{V}} \cdot \nabla\hat{\mathbf{V}} - i \frac{\lambda^2}{2\tau} \left(\frac{dt}{\tau} \right)^{(2/D_F)-1} \nabla^2\hat{\mathbf{V}} \equiv 0 \quad (10)$$

This means that the sum of the local acceleration $\partial\hat{\mathbf{V}}/\partial t$, convection $\hat{\mathbf{V}} \cdot \nabla\hat{\mathbf{V}}$ and "dissipation" $\nabla^2\hat{\mathbf{V}}$ reciprocally compensate in any point of the arbitrarily fractal chosen trajectory of a physical object.

Formally, (10) is a Navier-Stokes type equation, with an imaginary viscosity coefficient,

$$\eta = i \frac{\lambda^2}{2\tau} \left(\frac{dt}{\tau} \right)^{(2/D_F)-1} \quad (11)$$

This coefficient depends on two temporary scales, as well as on a length scale. The existence of a pure imaginary structured coefficient specifies the fact that "the environment" has rheological features (viscoelastic and hysteretic ones (Chioroiu, V. et al, 2005; Ferry, D. K. & Goodnick, S. M., 2001; Imry, Y., 2002)).

For

$$\frac{\lambda^2}{2\tau} \cdot \left(\frac{dt}{\tau} \right)^{(2/D_F)-1} \rightarrow 0 \quad (12)$$

equation (10) reduces to Euclidian form (Harabagiu A. et al , 2010; Agop, M. et al, 2008):

$$\frac{\partial\hat{\mathbf{V}}}{\partial t} + \hat{\mathbf{V}} \cdot \nabla\hat{\mathbf{V}} \equiv 0 \quad (13)$$

and, hence, separating the real part from the imaginary one

$$\begin{aligned} \frac{\partial\mathbf{V}}{\partial t} + \mathbf{V} \cdot \nabla\mathbf{V} - \mathbf{U} \cdot \nabla\mathbf{U} &= 0 \\ \frac{\partial\mathbf{U}}{\partial t} + \mathbf{U} \cdot \nabla\mathbf{V} + \mathbf{V} \cdot \nabla\mathbf{U} &= 0 \end{aligned} \quad (14a,b)$$

Equation (14a) corresponds to the law of the impulse conservation at differentiable scale (the undulatory component), while (14b) corresponds to the same law, but at a non differentiable scale (corpuscular component). As we will later show, in the case of irrotational movements (14) it will be assimilated to the law of mass conservation.

6. Rotational motions and flow regimes of a fractal fluid

For rotational motions, $\nabla \times \hat{\mathbf{V}} \neq 0$ relation (10) with (9) through separating the real part from the imaginary one, i.e. through separating the motions at a differential scale (undulatory characteristic) and non differential one (corpuscular characteristic), results (Harabagiu A. et al , 2010)

$$\begin{aligned} \frac{\partial\mathbf{V}}{\partial t} + \mathbf{V} \cdot \nabla\mathbf{V} - \mathbf{U} \cdot \nabla\mathbf{U} - \frac{\lambda^2}{2\tau} \left(\frac{dt}{\tau} \right)^{(2/D_F)-1} \Delta\mathbf{U} &= 0 \\ \frac{\partial\mathbf{U}}{\partial t} + \mathbf{U} \cdot \nabla\mathbf{V} + \mathbf{V} \cdot \nabla\mathbf{U} + \frac{\lambda^2}{2\tau} \left(\frac{dt}{\tau} \right)^{(2/D_F)-1} \Delta\mathbf{V} &= 0 \end{aligned} \quad (15a,b)$$

According to the operator relations

$$\begin{aligned}
\mathbf{V} \cdot \nabla \mathbf{V} &= \nabla \left(\frac{\mathbf{V}^2}{2} \right) - \mathbf{V} \times (\nabla \times \mathbf{V}) \\
\mathbf{U} \cdot \nabla \mathbf{U} &= \nabla \left(\frac{\mathbf{U}^2}{2} \right) - \mathbf{U} \times (\nabla \times \mathbf{U}) \\
\mathbf{U} \cdot \nabla \mathbf{V} + \mathbf{V} \cdot \nabla \mathbf{U} &= \nabla(\mathbf{U} \cdot \mathbf{V}) - \mathbf{V} \times (\nabla \times \mathbf{U}) - \mathbf{U} \times (\nabla \times \mathbf{V})
\end{aligned} \tag{16a-c}$$

equations (15) take equivalent forms

$$\begin{aligned}
\frac{\partial \mathbf{V}}{\partial t} + \nabla \left(\frac{\mathbf{V}^2}{2} - \frac{\mathbf{U}^2}{2} \right) - \mathbf{V} \times (\nabla \times \mathbf{V}) - \mathbf{U} \times (\nabla \times \mathbf{U}) - \frac{\lambda^2}{2\tau} \left(\frac{dt}{\tau} \right)^{(2/D_f)-1} \Delta \mathbf{U} &= 0 \\
\frac{\partial \mathbf{U}}{\partial t} + \nabla(\mathbf{V} \cdot \mathbf{U}) - \mathbf{V} \times (\nabla \times \mathbf{U}) - \mathbf{U}(\nabla \times \mathbf{V}) + \frac{\lambda^2}{2\tau} \left(\frac{dt}{\tau} \right)^{(2/D_f)-1} \Delta \mathbf{V} &= 0
\end{aligned} \tag{17a,b}$$

We can now characterize the flow regimes of the fractal fluid at different scales, using some classes of Reynolds numbers. At a differential scale we have

$$R(\text{differential} - \text{nondifferential}) = R(D - N) = \frac{|V \cdot \nabla V|}{D|\Delta U|} \approx \frac{V^2 l^2}{DUL} \tag{18}$$

$$R(\text{nondifferential} - \text{nondifferential}) = R(N - N) = \frac{|U \cdot \nabla U|}{D|\Delta U|} \approx \frac{UL}{D} \tag{19}$$

with

$$D = \frac{\lambda^2}{2\tau} \left(\frac{dt}{\tau} \right)^{(2/D_f)-1} \tag{20}$$

and at nondifferential scale

$$R(\text{differential-non differential-differential transition}) = R(\text{TDN-D}) = \frac{|U \cdot \nabla V|}{D|\Delta V|} \approx \frac{UL}{D} \tag{21}$$

$$R(\text{non differential-differential-differential transition}) = R(\text{TND-D}) = \frac{|V \cdot \nabla U|}{D|\Delta V|} \approx \frac{UL^2}{Dl} \tag{22}$$

In previous relations V, L, D , are the specific parameters, while U, l, D are the parameters of the non differential scale. The parameters V, U are specific speeds, L, l specific lengths and D is a viscosity coefficient. Moreover, the common "element" for $R(D-N)$, $R(N-N)$, $R(\text{TDN-D})$ and $R(\text{TND-D})$ is the "viscosity" which, through (20) is imposed by the resolution scale.

Equations (15) are simplified in the case of the stationary motion for small Reynolds numbers. Thus, equation (15) for small $R(D-N)$ becomes

$$-\mathbf{U} \cdot \nabla \mathbf{U} - \frac{\lambda^2}{2\tau} \left(\frac{dt}{\tau} \right)^{(2/D_f)-1} \Delta \mathbf{U} = 0 \tag{23}$$

and for small R(N-N)

$$-\mathbf{V} \cdot \nabla \mathbf{V} - \frac{\lambda^2}{2\tau} \left(\frac{dt}{\tau} \right)^{(2/D_F)-1} \Delta \mathbf{U} = 0 \quad (24)$$

Equation (15b) for small R(TDN-D) takes the form

$$\mathbf{V} \cdot \nabla \mathbf{U} + \frac{\lambda^2}{2\tau} \left(\frac{dt}{\tau} \right)^{(2/D_F)-1} \Delta \mathbf{V} = 0 \quad (25)$$

and for small R(TND-D)

$$\mathbf{U} \cdot \nabla \mathbf{V} + \frac{\lambda^2}{2\tau} \left(\frac{dt}{\tau} \right)^{(2/D_F)-1} \Delta \mathbf{V} = 0 \quad (26)$$

7. Irrotational motions of a fractal fluid. The incorporation of the associate wave corpuscle through the solidarity of movements and generation of Schrodinger equation

For irrotational motions

$$\nabla \times \hat{\mathbf{V}} = 0 \quad (27)$$

which implies

$$\nabla \times \mathbf{V} = 0, \nabla \times \mathbf{U} = 0 \quad (28 \text{ a,b})$$

equation (10) (condition of solidarity of movements) becomes (Harabagiu A. et al , 2010)

$$\frac{\partial \mathbf{V}}{\partial t} + \nabla \left(\frac{\mathbf{V}^2}{2} \right) - i \frac{\lambda^2}{2\tau} \left(\frac{dt}{\tau} \right)^{(2/D_F)-1} \Delta \mathbf{V} = 0 \quad (29)$$

Since through (27) the complex speed field is expressed by means of a scalar function gradient Φ ,

$$\hat{\mathbf{V}} = \nabla \Phi \quad (30)$$

equation (29) taking into account the operator identities

$$\frac{\partial}{\partial t} \nabla = \nabla \frac{\partial}{\partial t}, \quad \nabla \Delta = \Delta \nabla \quad (31)$$

takes the form

$$\nabla \left[\frac{\partial \Phi}{\partial t} + \frac{1}{2} (\nabla \Phi)^2 - i \frac{\lambda^2}{2\tau} \left(\frac{dt}{\tau} \right)^{(2/D_F)-1} \Delta \Phi \right] = 0 \quad (32)$$

or furthermore, through integration

$$\frac{\partial\Phi}{\partial t} + \frac{1}{2}(\nabla\Phi)^2 - i\frac{\lambda^2}{2\tau}\left(\frac{dt}{\tau}\right)^{(2/D_F)-1} \Delta\Phi = F(t) \quad (33)$$

where $F(t)$ is an arbitrary function depending only on time. In particular, for Φ having the form

$$\Phi = -2i\frac{\lambda^2}{2\tau}\left(\frac{dt}{\tau}\right)^{(2/D_F)-1} \ln\Psi \quad (34)$$

where Ψ is a new complex scalar function, equation (46), with the operator identity

$$\frac{\Delta\Psi}{\Psi} = \Delta\ln\Psi + (\nabla\ln\Psi)^2 \quad (35)$$

takes the form :

$$\frac{\lambda^4}{4\tau^2}\left(\frac{dt}{\tau}\right)^{(4/D_F)-2} \Delta\Psi + i\frac{\lambda^2}{2\tau}\left(\frac{dt}{\tau}\right)^{(2/D_F)-1} \frac{\partial\Psi}{\partial t} + \frac{F(t)}{2}\Psi = 0 \quad (36)$$

The Schrodinger “geodesics” can be obtained as a particular case of equation (36), based on the following hypothesis (conditions of solidarity of the motion, incorporating the associated wave corpuscle):

- i. the motions of the micro-particles take place on fractal curves with the fractal dimension $D_F=2$, i.e. the Peano curves (Nottalle, L., 1993; Nottalle, L., 2004);
- ii. $d_{\pm}\xi^i$ are the Markov-Wiener type stochastic variables (Nottalle, L., 1993; Nottalle, L., 2004) that satisfy the rule

$$\langle d_{\pm}\xi^i d_{\pm}\xi^l \rangle = \pm\delta^{il} \frac{\lambda^2}{\tau} dt \quad (37)$$

- iii. space scale λ and temporary one τ are specific for the Compton scale

$$\lambda = \frac{\hbar}{m_0 c}, \quad \tau = \frac{\hbar}{m_0 c^2} \quad (38)$$

with m_0 the rest mass of the microparticle, c the speed of light in vacuum and \hbar the reduced Planck constant. The parameters (38) should not be understood as “structures” of the standard space-time, but as standards of scale space-time; iv) function $F(t)$ from (36) is null. Under these circumstances, (36) is reduced to the standard form of Schrodinger’s equation (Tițeica, S., 1984; Peres, A., 1993)

$$\frac{\hbar^2}{2m_0} \Delta\Psi + i\hbar \frac{\partial\Psi}{\partial t} = 0 \quad (39)$$

In such a context, the scale potential of the complex speeds plays the role of the wave function.

8. Extended hydrodynamic model of scale relativity and incorporation of associated wave corpuscle through fractal potential. The correspondence with Madelung model

Substituting the complex speed (9) with the restriction (27) and separating the real part with the imaginary one, we obtain the set of differential equations (Harabagiu A. et al , 2010)

$$\begin{aligned} m_0 \frac{\partial \mathbf{V}}{\partial t} + m_0 \nabla \left(\frac{\mathbf{V}^2}{2} \right) &= -\nabla(Q) \\ \frac{\partial \mathbf{U}}{\partial t} + \nabla(\mathbf{V} \cdot \mathbf{U}) + \frac{\lambda^2}{2\tau} \left(\frac{dt}{\tau} \right)^{(2/D_f)-1} \Delta \mathbf{V} &= 0 \end{aligned} \quad (40a,b)$$

where Q is the fractal potential, expressed as follows

$$Q = -\frac{m_0 \mathbf{U}^2}{2} - \frac{m_0}{2} \frac{\lambda^2}{2\tau} \left(\frac{dt}{\tau} \right)^{(2/D_f)-1} \nabla \cdot \mathbf{U} \quad (41)$$

For

$$\Psi = \sqrt{\rho} e^{iS} \quad (42)$$

with $\sqrt{\rho}$ an amplitude and S a phase, then (34) under the form

$$\Phi = -i \frac{\lambda^2}{\tau} \left(\frac{dt}{\tau} \right)^{(2/D_f)-1} \ln(\sqrt{\rho} e^{iS})$$

implies the complex speed fields of components

$$\mathbf{V} = \frac{\lambda^2}{2\tau} \left(\frac{dt}{\tau} \right)^{(2/D_f)-1} \nabla S, \quad \mathbf{U} = \frac{\lambda^2}{2\tau} \left(\frac{dt}{\tau} \right)^{(2/D_f)-1} \nabla \ln \rho \quad (43a,b)$$

From the perspective of equations (43), the equation (40) keeps its form, and the fractal potential is given by the simple expression

$$Q = -m_0 \frac{\lambda^2}{\tau} \left(\frac{dt}{\tau} \right)^{(2/D_f)-1} \frac{\Delta \sqrt{\rho}}{\sqrt{\rho}} \quad (44)$$

Again through equations (43), equation (40b) takes the form:

$$\nabla \left(\frac{\partial \ln \rho}{\partial t} + \mathbf{V} \cdot \nabla \ln \rho + \nabla \cdot \mathbf{V} \right) = 0$$

or, still, through integration with $\rho \neq 0$

$$\frac{\partial \rho}{\partial t} + \nabla \cdot (\rho \mathbf{V}) = T(t) \quad (45)$$

with $T(t)$, an exclusively time dependent function

Equation (40) corresponds to the impulse conservation law at differential scale (the classical one), while the impulse conservation law at non differential scale is expressed through (45) with $T(t) \equiv 0$, as a probability density conservation law

Therefore, equations

$$m_0 \left(\frac{\partial \mathbf{V}}{\partial t} + \mathbf{V} \cdot \nabla \left(\frac{\mathbf{V}^2}{2} \right) \right) = -\nabla(Q) \quad (46a,b)$$

$$\frac{\partial \rho}{\partial t} + \nabla \cdot (\rho \mathbf{V}) = 0$$

with Q given by (41) or (44) forms the set of equations of scale relativity extended hydrodynamics in fractal dimension D_F . We mention that in references (Nottalle, L., 1993; Chaline, J. et al, 2009; Chaline, J. et al, 2000; Nottalle, L., 2004) the model has been extended only for $D_F=2$. The fractal potential (41) or (44) is induced by the non differentiability of space-time.

In an external scalar field U , the system of equations (46) modifies as follows

$$m_0 \left[\frac{\partial \mathbf{V}}{\partial t} + \nabla \left(\frac{\mathbf{V}^2}{2} \right) \right] = -\nabla(Q + U) \quad (47a,b)$$

$$\frac{\partial \rho}{\partial t} + \nabla(\rho \mathbf{V}) = 0$$

Now the quantum mechanics in hydrodynamic formula (Madelung's model (Halbwachs, F., 1960)) is obtained as a particular case of relations (47), using the following hypothesis: i) the motion of the micro-particles takes place on Peano curves with $D_F=2$; ii) $d_{\pm} \xi^i$ are the Markov-Wiener variables (Nottalle, L., 1993; Chaline, J. et al, 2009; Chaline, J. et al, 2000; Nottalle, L., 2004); iii) the time space scale is a Compton one. Then, (38) have the expressions

$$\mathbf{V} = \frac{\hbar}{m_0} \nabla S, \quad \mathbf{U} = \frac{\hbar}{2m_0} \nabla \ln \rho \quad (48)$$

and (41),

$$Q = -\frac{m_0 \mathbf{U}^2}{2} - \frac{\hbar}{2} \nabla \cdot \mathbf{U} \quad (49)$$

9. "Mechanisms" of duality through coherence in corpuscle-wave phase

In the stationary case, the system of equations (46) becomes (Harabagiu A. et al , 2010)

$$\nabla \left(\frac{\mathbf{V}^2}{2} + Q \right) = 0 \quad (50a,b)$$

$$\nabla(\rho \mathbf{V}) = 0$$

or, still, through integration

$$\begin{aligned}\frac{\mathbf{V}^2}{2} + Q &= E = \text{const.} \\ \rho \mathbf{V} &= \text{const.}\end{aligned}\quad (51a,b)$$

Let us choose the null power density in (51b). Then there is no impulse transport at differential scale between corpuscle and wave. Moreover, for $\rho \neq 0$

$$\mathbf{V} = 0 \quad (52)$$

which implies through relation (43)

$$S = \text{const.} \quad (53)$$

In other words, the fluid becomes coherent (the fluid particles have the same phase). Such a state is specific for quantum fluids (Ciuti C. & Camsotto I., 2005; Benoit Deveand, 2007), such as superconductors, superfluids, etc. (Felsager, B., 1981; Poole, C. P. et al, 1995). Under such circumstances, the phase of the corpuscle considered as a small horologe equals the phase of the associated wave (coherence in corpuscle-wave phase).

At non-differential scale, equation (51) , with restriction (52) takes the form

$$\begin{aligned}Q &= -\frac{2m_0 D^2 \Delta \sqrt{\rho}}{\sqrt{\rho}} = -\frac{m_0 \mathbf{U}^2}{2} - m_0 D \nabla \mathbf{U} = E = \text{const} \\ D &= \frac{\lambda^2}{\tau} \left(\frac{dt}{\tau} \right)^{(2/D_f)-1}\end{aligned}\quad (54 a,b)$$

or, still, by applying the gradient operator

$$\mathbf{A} = \nabla(\sqrt{\rho}) \quad (55)$$

$$\Delta \mathbf{A} + \frac{E}{2m_0 D^2} \mathbf{A} = 0 \quad (56)$$

We distinguish the following situations

i. For $E > 0$ and with substitution

$$\frac{1}{\Lambda^2} = \frac{E}{2m_0 D^2} \quad (57)$$

equation (56) becomes

$$\Delta \mathbf{A} + \frac{1}{\Lambda^2} \mathbf{A} = 0 \quad (58)$$

Therefore:

1. the space oscillations of field \mathbf{A} and, therefore the space associated with the motion of coherent fluid particles is endowed with regular non homogeneities (of lattice type). In other words, the field \mathbf{A} crystallizes ("periodicizes") the space. The one dimensional space "crystal" has the constant of the network

$$\Lambda = \frac{\lambda^2 \left(\frac{dt}{\tau} \right)^{(2/D_F)-1} \left(\frac{2m_0}{E} \right)^{1/2}}{2\tau} \quad (59)$$

that depends both on the “viscosity” - η given by (11) and on the energy of the particle;

2. the one dimensional geodesics of the “crystallized” space given by the expression

$$\rho(x) = A^2 \sin^2(kx + \delta) \quad (60)$$

implies both fractal speed

$$U_x = D \frac{d \ln \rho}{dx} = 2Dkctg(kx + \delta) \quad (61)$$

and fractal potential

$$\begin{aligned} Q_x &= -\frac{m_0 U_x^2}{2} - m_0 D \frac{dU_x}{dx} = -2m_0 D^2 k^2 ctg^2(kx + \delta) \\ &+ 2m_0 D^2 k^2 \frac{1}{\sin^2(kx + \delta)} = 2m_0 D^2 k^2 \end{aligned} \quad (62)$$

with A and δ and the integration constants

$$k = \frac{1}{\Lambda} \quad (63)$$

3. for the movements of microparticles on Peano curves ($D_F=2$) at Compton scale

$$D = 2m_0 \hbar ,$$

therefore, through (62) under the form

$$Q_x = 2m_0 D^2 k^2 = \frac{p_x^2}{2m_0}, \quad p_x = 2m_0 Dk \quad (64a,b)$$

de Broglie “quantum” impulse is found

$$p_x = \frac{\hbar}{\Lambda} \quad (65)$$

4. the dominant of the undulatory characteristic is achieved by the “self diffraction” mechanism of the fractal field, ρ , on the one dimensional space “crystal” of constant Λ induced by the same field. Indeed, relation (61) with notations

$$\Phi = kx + \delta, \quad k = \frac{1}{\Lambda} \quad (66a,b)$$

in approximation $\Phi \ll 1$, i.e. for $tg\Phi \approx \sin\Phi$ and using Nottale’s relation (Nottale, L., 1993; Chaline, J. et al, 2009; Chaline, J. et al, 2000; Nottale, L., 2004; Nottale, L. &

Schneider J., 1984; Nottale, L., 1989; Nottale, L., 1996) $2D / U_x \approx n\lambda$ it takes the common form (Bragg's relation)

$$\Lambda \sin \Phi \approx n\lambda; \quad (67)$$

This result is in concordance with the recently expressed opinion in (Mandelis A. et al, 2001; Grössing G., 2008; Mandelis A., 2000);

5. there is impulse transfer on the fractal field between the corpuscle and the wave;
 6. according to Taylor's criterion (Popescu, S., 2004) self-organization (crystallization and self diffraction of the space) appears when the energy of the system is minimal. This can be immediately verified using relation (51a);
- ii. For $E=0$, equations (51a) and (56) have the same form

$$\Delta\sqrt{\rho}=0 \quad \Delta\mathbf{A} = 0 \quad (68)$$

It follows that:

1. the geodesics are expressed through harmonic functions and the particle finds itself in a critical state, i.e. the one that corresponds to the wave-corpuscle transition;
2. in the one -dimensional case, the geodesics have the form

$$\rho(x) = kx + \delta \quad (69)$$

which induces the fractal speed field

$$U_x = \frac{D}{kx + \delta} \quad (70)$$

namely the null value of the fractal potential

$$Q_x = -\frac{m_0}{2} \frac{D^2}{(kx + \delta)^2} + \frac{m_0}{2} \frac{D^2}{(kx + \delta)^2} = 0 \quad (71)$$

3. although the energy is null, there is impulse transfer between corpuscle and wave on the fractal component of the speed field
- iii. For $E<0$ and with notations

$$\frac{1}{\bar{\Lambda}^2} = \frac{\bar{E}}{2m_0D^2}, \quad E = -\bar{E} \quad (72)$$

equation (56) takes the form

$$\Delta\mathbf{A} - \frac{1}{\bar{\Lambda}^2}\mathbf{A} = 0 \quad (73)$$

The following aspects result:

1. field A is expelled from the structure, its penetration depth being

$$\bar{\Lambda} = \frac{\lambda^2}{2\tau} \left(\frac{dt}{\tau} \right)^{(2/D_f)-1} \left(\frac{2m_0}{\bar{E}} \right)^{1/2} \quad (74)$$

2. the one-dimensional geodesics of the space are described through function

$$\rho(x) = \bar{A}^2 sh^2(\bar{k}x + \bar{\delta}) \quad (75)$$

and lead to the fractal speed

$$U_x = 2D\bar{k}cth(\bar{k}x + \bar{\delta}) \quad (76)$$

the fractal potential respectively

$$Q_x = -2m_0D^2\bar{k}^2cth^2(\bar{k}x + \bar{\delta}) + 2m_0D^2\frac{\bar{k}^2}{sh^2(\bar{k}x + \bar{\delta})} = -2m_0D^2\bar{k}^2 \quad (77)$$

where \bar{A} , $\bar{\delta}$ are two integration constants and

$$\bar{k} = \frac{1}{\Lambda} \quad (78)$$

3. the dominant of the corpuscular characteristic is accomplished by means of "self-expulsion" mechanism of the fractal field from its own structure that it generates (that is the corpuscle), the penetration depth being $\bar{\Lambda}$. The identification

$$Q_x = -2m_0D^2\bar{k}^2 = \frac{\bar{p}^2}{2m_0} \quad (79)$$

implies the purely imaginary impulse

$$\bar{p} = -2im_0D\bar{k} \quad (80)$$

that suggests ultra rapid virtual states (ultra rapid motions in the wave field, resulting in the "singularity" of the field, i.e. the corpuscle). As a matter of fact, if we consider de Broglie's original theory (motions on Peano curves with $D_F=2$, at Compton's scale), singularity (the corpuscle) moves "suddenly" and chaotically in the wave field, the wave-corpuscle coupling being accomplished through the fractal potential. The corpuscle "tunnels" the potential barrier imposed by the field of the associate progressive wave, generating particle-antiparticle type pairs (ghost type fields (Bittner E.R., 2000)). Nevertheless this model cannot specify the type of the physical process by means of which we reach such a situation: it is only the second quantification that can do this (Ciuti C. & Camsotto I., 2005; Benoit Deveand Ed., 2007; Mandelis A. et al, 2001; Grössing G., 2008; Mandelis A., 2000; Bittner E.R., 2000);

4. there is an impulse transfer between the corpuscle and the wave on the fractal component of the speed field, so that all the attributes of the differential speed could be transferred on the fractal speed.

All the above results indicate that wave-particle duality is an intrinsic property of space and not of the particle.

10. Wave-corpuscule duality through flowing stationary regimes of a coherent fractal fluid in phase. The potential well

According to the previous paragraph, let us study the particle in a potential well with infinite width and walls. Then the speed complex field has the form (Harabagiu A. et al, 2010; Agop, M. et al, 2008; Harabagiu, A. & Agop, M., 2005; Harabagiu, A. et al, 2009)

$$\hat{V}_x = V_x - iU_x = 0 - 2iD \left(\frac{n\pi}{a} \right) \text{ctg} \left(\frac{n\pi}{a} \right) x \quad (81)$$

and generates the fractal potential (the energy of the structure) under the form of the noticeable

$$Q_n = 2m_0 D^2 \left(\frac{n\pi}{a} \right)^2 = E_n \quad (82)$$

The last relation (82) allows the implementation of Reynold's criterion

$$R(n) = \frac{V_c a}{D} = 2n\pi, \quad V_c = \left(\frac{2E_n}{m_0} \right)^{\frac{1}{2}} \quad (83a,b)$$

For movements on Peano curves ($D_F=2$) at Compton scale ($2m_0 D = \hbar$) (83) with substitutions

$$m_0 V_c = \Delta P_x, \quad a = \Delta x \quad (84a,b)$$

and $n=1$ reduces to Heinsenberg's relation of uncertainty under equal form

$$\Delta p_x \Delta x = \frac{\hbar}{2} \quad (85)$$

while for $n < +\infty$ it implies a Ruelle-Takens' type criterion of evolution towards chaos (Ruelle D. & Takens, F., 1971; Ruelle, D., 1975). Therefore, the wave-corpuscule duality is accomplished through the flowing regimes of a fractal fluid that is coherent in phase. Thus, the laminar flow (small n) induces a dominant ondulatory characteristic, while the turbulent flow (big n) induces a dominant corpuscular characteristic.

11. Wave-corpuscule duality through non-stationary regimes of an incoherent fractal fluid

In the one dimensional case the equations of hydrodynamics (46) take the form

$$m_0 \left(\frac{\partial V}{\partial t} + V \cdot \frac{\partial V}{\partial x} \right) = - \frac{\partial}{\partial x} \left[-2m_0 D^2 \frac{1}{\rho^{1/2}} \frac{\partial^2}{\partial x^2} (\rho^{1/2}) \right]; \quad \frac{\partial \rho}{\partial t} + \frac{\partial}{\partial x} (\rho V) = 0 \quad (86a,b)$$

Imposing the initial conditions

$$V(x, t=0) = c = \text{const} \quad (87a,b)$$

$$\rho(x, t=0) = \frac{1}{\pi^{1/2} a} e^{-\left(\frac{x}{a}\right)^2} = \rho_0$$

and on the frontier

$$\begin{aligned} V(x = ct, t) &= c \\ \rho(x = -\infty, t) &= \rho(x = +\infty, t) = 0 \end{aligned} \quad (88a,b)$$

the solutions of the system (86), using the method in (Munceleanu, C.V. et al, 2010), have the expressions

$$\begin{aligned} \rho(x, t) &= \frac{1}{\pi^{1/2} \left[\alpha^2 + \left(\frac{2D}{\alpha} t \right)^2 \right]^{1/2}} \exp \left[\frac{(x - ct)^2}{\alpha^2 + \left(\frac{2D}{\alpha} t \right)^2} \right] \\ V &= \frac{c\alpha^2 + \left(\frac{2D}{\alpha} \right)^2 tx}{\alpha^2 + \left(\frac{2D}{\alpha} t \right)^2} \end{aligned} \quad (89a,b)$$

The complex speed field is obtained

$$\hat{V} = V - iU = \frac{c\alpha^2 + \left(\frac{2D}{\alpha} \right)^2 tx}{\alpha^2 + \left(\frac{2D}{\alpha} t \right)^2} + 2iD \frac{x - ct}{\alpha^2 + \left(\frac{2D}{\alpha} t \right)^2} \quad (90)$$

and the field of fractal forces

$$F = 4m_0 D^2 \frac{(x - ct)}{\left[\alpha^2 + \left(\frac{2D}{\alpha} t \right)^2 \right]^2} \quad (91)$$

Therefore:

- i. both differential scale speed V and non-differential one U are not homogeneous in x and t . Under the action of fractal force F , the corpuscle is assimilated to the wave, is a part of its structure, so that it joins the movement of the corpuscle with the propagation of the associated progressive wave;
- ii. the timing of the movements at the two scales, $V=U$ implies the space-time homographic dependence

$$x = \frac{c\alpha^2}{2D} \frac{1 + \frac{2D}{\alpha^2} t}{1 - \frac{2D}{\alpha^2} t} \quad (92)$$

in the field of forces

$$F = \frac{2m_0 Dc}{\left(1 - \frac{2D}{\alpha^2}t\right) \left[\alpha^2 + \left(\frac{2D}{\alpha}t\right)^2\right]} \quad (93)$$

Considering that the type (92) changes are implied in gravitational interaction (Ernst, F.J., 1968; Ernst, F.J., 1971), it follows that the solidarity of the corpuscle movement with the movement of the associated progressive wave is accomplished by means of the appropriate gravitational field of the physical object;

- iii. the uniform movement $V=c$ is obtained for null fractal force $F=0$ and fractal speed $U=0$, using condition $x=ct$. The fractal forces in the semi space. $-\infty \leq x \leq \bar{x}$ and $x \leq x \leq +\infty$ are reciprocally compensated.

$$F|_{-\infty}^{\bar{x}} = F|_{\bar{x}}^{+\infty}$$

This means that the corpuscle in "free" motion simultaneously polarizes the "environment" of the wave behind $x \leq ct$ and in front of $x \geq ct$, in such a manner that the resulting force has a symmetrical distribution as compared with the plane that contains the position of the noticeable object $\bar{x} = ct$ at any time moment t . Under such circumstances, the physical object uniformly moves (the corpuscle is located in the field of the associated wave).

12. The corpuscle as a horologe and its incorporation in the associated wave. Consequences

According to de Broglie's theory, the corpuscle must be associated to a horologe having the frequency equal to that of the associated progressive wave. Mathematically we can describe such an oscillator through the differential equation

$$\ddot{q} + \omega^2 q = 0 \quad (94)$$

where ω defines the natural frequency of the oscillator as it is dictated by the environment (the wave), and the point above the symbol refers to the differential as compared with time. The most general solution of equation (94) generally depends not on two arbitrary constants, as it is usually considered, but on three: the initial relevant coordinate, the initial speed and the phase of the harmonic oscillatory within the ensemble that structurally represents the environment (the isolated oscillator is an abstraction !). Such a solution gives the relevant co-ordinate

$$q(t) = h e^{i(\omega t + \Phi)} + \bar{h} e^{-i(\omega t + \Phi)} \quad (95)$$

where \bar{h} refers to the complex conjugate of h and Φ is an initial phase specific to the individual movement of the oscillator. Such a notation allows us to solve a problem that we could name "the oscillators with the same frequency", such as Planck's resonators' ensemble-the basis of the quantum theory arguments in their old shape. That is, given an ensemble of oscillators having the same frequency in a space region, which is the relation between them?

The mathematical answer to this problem can be obtained if we note that what we want here is to find a mean to pass from a triplet of numbers -the initial conditions- of an oscillator

towards the same triplet of another oscillator with the same frequency. This process (passing) implies a simple transitive continuous group with three parameters that can be built using a certain definition of the frequency. We start from the idea that the ratio of two fundamental solutions of equation (94) is a solution of Schwarts' non linear equation (Agop, M. & Mazilu, N., 1989; Agop, M. & Mazilu, N., 2010; Mihăileanu, N., 1972)

$$\frac{d}{dt} \left(\frac{\ddot{\tau}_0}{\dot{\tau}_0} \right) - \frac{1}{2} \left(\frac{\ddot{\tau}_0}{\dot{\tau}_0} \right)^2 = 2\omega^2, \quad \tau_0(t) \equiv e^{-2i\omega t} \quad (96)$$

This equation proves to be a veritable definition of frequency as a general characteristic of an ensemble of oscillators that can be scanned through a continuous group of three parameters. Indeed equation (96) is invariant to the change of the dependent variable

$$\tau(t) = \frac{a\tau_0(t) + b}{c\tau_0(t) + d} \quad (97)$$

which can be verified through direct calculation. Thus, $\tau(t)$ characterizes another oscillator with the same frequency which allows us to say that, starting from a standard oscillator we can scan the whole ensemble of oscillators of the same frequency when we let loose the three ratios a: b: c: d in equation (97). We can make a more precise correspondence between a homographic change and an oscillator, by means of associating to each oscillator a personal $\tau(t)$ through equation

$$\tau_1(t) = \frac{h + \bar{h}k\tau_0(t)}{1 + k\tau_0(t)} \quad k \equiv e^{-2i\Phi} \quad (98)$$

Let us notice that τ_0, τ_1 can be freely used one instead the other, which leads to the next group of changes for the initial conditions

$$h' \rightarrow \frac{ah + b}{ch + d} \quad \bar{h}' \rightarrow \frac{a\bar{h} + b}{c\bar{h} + d} \quad k' \rightarrow k \cdot \frac{c\bar{h} + d}{ch + d} \quad a, b, c, d \in \mathbb{R} \quad (99a-d)$$

This is a simple transitive group: one and only one change of the group (the Barbilian group (Agop, M. & Mazilu, N., 1989; Agop, M. & Mazilu, N., 2010; Barbilian, D., 1935; Barbilian, D., 1935; Barbilian, D., 1938; Barbilian, D., 1971)) corresponds to a given set of values (a/c, b/c, d/c).

This group admits the 1-differential forms, absolutely invariant through the group (Agop, M. & Mazilu, N., 1989)

$$\omega_0 = i \left(\frac{dk}{k} - \frac{dh + d\bar{h}}{h - \bar{h}} \right), \quad \omega_1 = \bar{\omega}_2 = \frac{dh}{k(h - \bar{h})} \quad (100)$$

and the 2- differential form

$$\frac{ds^2}{\alpha^2} = \omega_0^2 - 4\omega_1\omega_2 = - \left(\frac{dk}{k} - \frac{dh - d\bar{h}}{h - \bar{h}} \right)^2 + 4 \frac{dh d\bar{h}}{(h - \bar{h})^2}, \quad \alpha = \text{const.} \quad (101)$$

respectively.

If we restrict the definition of a parallelism of directions in Levi-Civita manner (Agop, M. & Mazilu, N., 1989)

$$d\varphi = -\frac{du}{v} \quad (102)$$

with

$$h = u + iv, \bar{h} = u - iv, k = e^{-i\varphi} \quad (103)$$

Barbilian's group invariates the metrics of Lobacevski's plane (Agop, M. & Mazilu, N., 1989),

$$\frac{ds^2}{\alpha^2} = -\frac{du^2 + dv^2}{v^2} \quad (104)$$

Metrics (104) coincides with the differential invariant that is built with the complex scalar field of the speed,

$$\frac{ds^2}{\alpha^2} \equiv d\phi d\bar{\phi} = (2Dds - iDd\ln\rho)(2Dds + iDd\ln\rho) = 4D^2(ds)^2 + D^2\left(\frac{d\rho}{\rho}\right)^2 \quad (105)$$

which admits the identities

$$\alpha = D, 2ds \equiv d\Phi = -\frac{du}{v}, d\ln\rho \equiv d\ln v \quad (106a-c)$$

Now, through a Matzner-Misner type principle one can obtain Ernst's principle of generating the symmetrical axial metrics (Ernst, F.J., 1968; Ernst, F.J., 1971)

$$\delta \int \frac{\nabla h \nabla \bar{h}}{(h - \bar{h})^2} \gamma^{1/2} d^3x = 0 \quad (106d)$$

where $\gamma = \det \gamma_{\alpha\beta}$ with $\gamma_{\alpha\beta}$ the metrics of the "environment".

Therefore, the incorporation of the corpuscle in the wave, considering that it functions as a horologe with the same frequency as that of the associated progressive wave, implies gravitation through Einstein's vacuum equations (equivalent to Ernst's principle (106d)). On the contrary, when the frequencies do not coincide, there is an induction of Stoler's group from the theory of coherent states (the parameter of the change is the very ratio of frequencies when creation and annihilation operators refer to a harmonic oscillator (Agop, M. & Mazilu, N., 1989)).

Let us note that the homographic changes (99) generalize the result (92). Moreover, if $a, b, c, d \in \mathbb{Z}$ then the Ernst type equations describe supergravitation $N=1$ (Green, M.B. et al, 1998).

13. Informational energy through the fractal potential of complex scalar speed field. The generation of forces

The informational energy of a distribution is defined through the known relation (Mazilu N. & Agop M., 1994),

$$E = -\int \rho \ln \rho dx \quad (107)$$

where $\rho(x)$ is the density of distributions, and we note by x , on the whole, the random variables of the problem, dx being the elementary measure of their field.

This functional represents a measure of the uncertainty degree, when defining the probabilities, i.e. it is positive, it increases when uncertainty also increases taken in the sense of expanding distribution and it is additive for sources that are independent as compared to uncertainty. If we admit the maximum of informational energy in the inference against probabilities, having at our disposal only a partial piece of information this is equivalent to frankly admitting the fact that we cannot know more. Through this, the distributions that we obtain must be at least displaced, as compared to the real ones, because there is no restrictive hypothesis regarding the lacking information. In other words, such a distribution can be accomplished in the highest number of possible modalities. The partial piece of information we have at our disposal, is given, in most cases, in the form of a $f(x)$ function or of more functions.

$$\bar{f} = \int \rho(x)f(x)dx \quad (108)$$

Relation (108), together with the standard relation of distribution density

$$\int \rho(x)dx = 1 \quad (109)$$

are now constraints the variation of the functional (107) has to subject to, in order to offer the distribution density corresponding to the maximum of informational energy. In this concrete case, Lagrange's non determined multipliers method directly leads to the well known exponential distribution

$$\rho(x) = \exp(-x - \mu f(x)) \quad (110)$$

Let us notice that through the fractal component of the complex scalar of speed field

$$\Phi = D \ln \rho \quad (111)$$

expression (107), ignoring the scale factor D , is identical with the average mean of (111)

$$E = -\frac{\bar{\Phi}}{D} = -\int \rho \ln \rho dx \quad (112)$$

In the particular case of a radial symmetry, imposing the constraints

$$\bar{r} = \int \rho(r)rdr \quad (113)$$

$$\int \rho(r)dr \equiv 1 \quad (114)$$

the distribution density $\rho(r)$ through the maximum of informational energy implies the expression

$$\rho(r) = \exp(-\lambda - \mu r), \quad \lambda, \mu = \text{const.} \quad (115)$$

or in notations

$$\exp(-\lambda) \equiv \rho_0, \quad \mu = 2/a \quad (116)$$

$$\rho(r) = \rho_0 e^{-\frac{2r}{a}} \quad (117)$$

Then the fractal speed

$$u = D \frac{d}{dr}(\ln \rho) = -\frac{2D}{a} = \text{const} \quad (118)$$

through the fractal potential

$$Q = -\frac{m_0 u^2}{2} - m_0 D^2 \left[\frac{d^2}{dr^2}(\ln \rho) + \frac{2}{r} \frac{d}{dr}(\ln \rho) \right] = -\frac{2m_0 D^2}{a} \left(\frac{1}{a} - \frac{2}{r} \right) \quad (119)$$

implies the fractal field of central forces

$$F(r) = -\frac{dQ}{dr} = -\frac{4m_0 D^2}{ar^2} \quad (120)$$

Consequently, the fractal "medium" by maximization of the informational energy becomes a source of central forces (gravitational or electric type).

14. Lorenz type mechanism of wave-corpuscule duality in non stationary systems

Impulse conservation law

Let us rewrite the system of equations (15) for an external scalar field U under the form

$$\begin{aligned} \frac{\partial \mathbf{V}}{\partial t} + \mathbf{V} \cdot \nabla \mathbf{V} - \mathbf{U} \cdot \nabla \mathbf{U} - D\Delta \mathbf{U} &= -\nabla U \\ \frac{\partial \mathbf{U}}{\partial t} + \mathbf{V} \cdot \nabla \mathbf{U} + \mathbf{U} \cdot \nabla \mathbf{V} + D\Delta \mathbf{V} &= 0 \end{aligned} \quad (121a,b)$$

with D given by relation (54). Hence, through their decrease and using substitution

$$\bar{\mathbf{V}} = \mathbf{V} - \mathbf{U} \quad (122)$$

we find

$$\frac{\partial \bar{\mathbf{V}}}{\partial t} + \bar{\mathbf{V}} \cdot \nabla \bar{\mathbf{V}} = 2\mathbf{U} \cdot \nabla \mathbf{U} + 2D\Delta \mathbf{U} + D\Delta \bar{\mathbf{V}} - \nabla U \quad (123)$$

Taking into account that the fractal term, $2\mathbf{U} \cdot \nabla \mathbf{U} + 2D\Delta \mathbf{U}$ intervenes as a pressure (for details see the kinetic significance of fractal potential Q (Bohm, D., 1952)) then we can admit the relation

$$2\mathbf{U} \cdot \nabla \mathbf{U} + 2D\Delta \mathbf{U} = -2 \left(-\frac{\mathbf{U}^2}{2} - D\nabla \cdot \mathbf{U} \right) = -2\nabla \left(\frac{Q}{m_0} \right) = -\frac{\nabla p}{\rho} \quad (124)$$

then equation (123) takes the usual form

$$\frac{\partial \mathbf{V}}{\partial t} + \bar{\mathbf{V}} \cdot \nabla \bar{\mathbf{V}} = -\frac{\nabla p}{\rho} - \nabla U + D\Delta \bar{\mathbf{V}} \quad (125)$$

In particular, if $\nabla U = \mathbf{g}$ is a gravitational acceleration (125) becomes

$$\frac{\partial \bar{\mathbf{V}}}{\partial t} + \bar{\mathbf{V}} \cdot \nabla \bar{\mathbf{V}} = -\frac{\nabla p}{\rho} - \mathbf{g} + D\Delta \bar{\mathbf{V}} \quad (126)$$

Energy conservation law

Energy conservation law, ε in the case of movements on fractal curves of fractal dimension D_F is written under the form

$$\frac{\hat{d}\varepsilon}{dt} = \frac{d\varepsilon}{dt} + \hat{\mathbf{V}} \cdot \nabla \varepsilon - iD\Delta \varepsilon = 0 \quad (127)$$

or, still, by separating the real part from the imaginary one

$$\frac{\partial \varepsilon}{\partial t} + \mathbf{V} \cdot \nabla \varepsilon = 0, \quad -\mathbf{U} \cdot \nabla \varepsilon = D\Delta \varepsilon \quad (128)$$

Hence, through addition and taking into account relation (122), we obtain the expression

$$\frac{\partial \varepsilon}{\partial t} + \bar{\mathbf{V}} \cdot \nabla \varepsilon = D\Delta \varepsilon \quad (129)$$

In particular, for $\varepsilon = 2m_0D\Omega$ with Ω the wave pulsation (for movements on Peano curves with $D_F=2$ at Compton scale $\varepsilon = \hbar\Omega$) the previous relation becomes

$$\frac{\partial \Omega}{\partial t} + \bar{\mathbf{V}} \cdot \nabla \Omega = D\Delta \Omega \quad (130)$$

Lorenz type "mechanism"

For an incompressible fractal fluid, the balance equations of the "impulse" -see (126), of the energy -see (129) and "mass" - see (46) with $\rho = \text{const.}$ and $\nabla \cdot \mathbf{U} = 0$ become

$$\begin{aligned} \frac{\partial \bar{\mathbf{V}}}{\partial t} + \bar{\mathbf{V}} \cdot \nabla \bar{\mathbf{V}} &= -\frac{\nabla p}{\rho} - \mathbf{g} + D\Delta \bar{\mathbf{V}} \\ \frac{\partial \varepsilon}{\partial t} + \bar{\mathbf{V}} \cdot \nabla \varepsilon &= D\Delta \varepsilon \\ \nabla \bar{\mathbf{V}} &= 0 \end{aligned} \quad (131a-c)$$

Let us take into account the following simplifying hypothesis:

- i. constant density, $\rho = \rho_0 = \text{const.}$ excepting the balance equation of the impulse where density is disturbed according to relation

$$\rho = \rho_0 + \delta\rho \quad (132)$$

ii. the energy “expansion” is a linear one

$$\rho = \rho_0 [1 - \alpha(\varepsilon - \varepsilon_0)] \quad (133)$$

with α the energy “dilatation” constant.

Under such circumstances, system (131) becomes

$$\begin{aligned} \rho_0 \left(\frac{\partial \bar{\mathbf{V}}}{\partial t} + \bar{\mathbf{V}} \cdot \nabla \bar{\mathbf{V}} \right) + \nabla p &= (\rho_0 + \delta\rho) \mathbf{g} + \rho_0 D\Delta \bar{\mathbf{V}} \\ \frac{\partial \varepsilon}{\partial t} + \bar{\mathbf{V}} \cdot \nabla \varepsilon &= D\Delta \varepsilon \\ \nabla \bar{\mathbf{V}} &= 0 \end{aligned} \quad (134a-c)$$

In order to study the dynamics of system (134), our description closely follows the approach in (Bârzu, A. et al, 2003).

The convection in the fractal fluid takes place when the ascending force that results from energy “dilatation” overcomes the viscous forces. Then we can define the Rayleigh number

$$R = \frac{|F_{asc}|}{|F_{visc}|} \approx \frac{\left| \frac{\delta\rho g}{\rho_0} \right|}{|D\Delta \bar{\mathbf{V}}|} \quad (135)$$

The variation of the density satisfies through (133) the relation

$$\frac{\delta\rho}{\rho_0} \approx \alpha\Delta\varepsilon \quad (136)$$

and the “energy” balance equation (134c) implies

$$\bar{\mathbf{V}} \approx \frac{D}{d} \quad (137)$$

where d is the thickness of the fractal fluid level. Substituting (136) and (137) in (135) we obtain Rayleigh’s number under the form

$$R = \frac{\alpha\beta g d^4}{D^2} \quad (138)$$

where $\beta = \Delta\varepsilon / d < 0$ is the energy gradient between the superior and inferior frontiers of fluid layer. In the case of convection, Rayleigh’s number plays the role of control parameter and takes place for

$$R > R_{critic}$$

In general, R is controlled through the gradient β of the energy.

As reference state, let us choose the stationary rest state ($\bar{\mathbf{V}} = 0$), for which equations (134a-c) take the form

$$\begin{cases} \nabla p_S = -\rho_S g \hat{z} = -\rho_0 [1 - \alpha(\varepsilon_S - \varepsilon_0)] g \hat{z} \\ \Delta \varepsilon_S = 0 \end{cases} \quad (139a,b)$$

where \hat{z} represents the versor of vertical direction. We take into account that pressure and ε vary only in vertical direction due to the considered symmetry. For ε the conditions on the frontier are

$$\varepsilon(x, y, 0) = \varepsilon_0, \quad \varepsilon(x, y, d) = \varepsilon_1 \quad (140a,b)$$

Integrating equation (139b) with these conditions on the frontier, it will follow that in the reference rest state, the profile of ε on vertical direction is linear.

$$\varepsilon_S = \varepsilon_0 - \beta z \quad (141)$$

Substituting (141) in (139) and integrating, we obtain

$$p_S(z) = p_0 - \rho_0 g \left(1 + \frac{\alpha \beta z}{2} \right) z \quad (142)$$

The features of the system in this state do not depend on coefficient D that appears in balance equations.

We study now the stability of the reference state using the method of small perturbations (Bârzu, A. et al, 2003). The perturbed state is characterized by

$$\begin{cases} \varepsilon = \varepsilon_S(z) + \theta(r, t) \\ \rho = \rho_S(z) + \delta \rho(r, t) \\ p = p_S(z) + \delta p(r, t) \\ \bar{\mathbf{V}} = \delta \bar{\mathbf{V}}(r, t) = (u, v, w) \end{cases} \quad (143a-d)$$

One can notice that the perturbations are time and position functions. Substituting (143) in equations (134) and taking into account (141) and (142) the following equations for perturbations (in linear approximation) are obtained:

$$\begin{aligned} \nabla \cdot \delta \bar{\mathbf{V}} &= 0 \\ \frac{\partial \theta}{\partial t} &= \beta w + D \nabla^2 \theta \\ \frac{\partial \delta \bar{\mathbf{V}}}{\partial t} &= -\frac{1}{\rho_0} \nabla \delta p + D \nabla^2 \delta \bar{\mathbf{V}} + g \alpha \theta \hat{z} \end{aligned} \quad (144a-d)$$

We introduce adimensional variables $\bar{\mathbf{r}}', t', \theta', \delta \bar{\mathbf{V}}', \delta p'$ through the changes

$$\mathbf{r}' = \frac{\mathbf{r}}{d}; \quad t' = \frac{t}{d^2/D}; \quad \theta' = \frac{\theta}{\left(\frac{D^2}{g \alpha d^3} \right)}; \quad \delta \bar{\mathbf{V}}' = \frac{\delta \bar{\mathbf{V}}}{D/d}; \quad \delta p' = \frac{\delta p}{\left(\rho_0 \frac{D^2}{d^2} \right)}$$

Replacing these changes and renouncing, for simplicity, at the prime symbol, the adimensional perturbations satisfy the equations

$$\begin{aligned}\frac{\partial \bar{\mathbf{V}}}{\partial t} + \bar{\mathbf{V}} \cdot \nabla \bar{\mathbf{V}} &= -\nabla p + \theta \hat{z} + \nabla^2 \bar{\mathbf{V}} \\ \frac{\partial \theta}{\partial t} + (\bar{\mathbf{V}} \cdot \nabla) \theta &= R w + \nabla^2 \theta \\ \nabla \cdot \bar{\mathbf{V}} &= 0\end{aligned}\quad (145)$$

where R is Rayleigh's number.

For $R > R_c$, the reference state becomes unstable, and the convection "patterns" appear. We consider them as being parallel therefore the speed vector will be always perpendicular to their axis. We assume the patterns parallel to the y axis, i.e., the speed component along this direction is zero.

The incompressibility condition becomes

$$u_x + w_z = 0 \quad (146)$$

Equation (146) is satisfied if and only if

$$u = -\psi_z; \quad w = \psi_x \quad (147)$$

where $\psi(x, y, z)$ defines Lagrange's current function. The speed field must satisfy the conditions on frontiers (the inferior and superior surfaces)

$$w|_{z=\pm 1/2} = 0 \quad (148)$$

If the frontiers are considered free (the superficial tension forces are neglected), the "shear" component of the pressure tensor is annulated

$$\frac{\partial u}{\partial z} \Big|_{z=\pm 1/2} = 0 \quad (149)$$

Using Lagrange's function, $\psi(x, y, z)$ the limit conditions (148) and (149) become

$$\begin{aligned}\Psi_x|_{z=\pm 1/2} &= 0 \\ \Psi_{zz}|_{z=\pm 1/2} &= 0\end{aligned}$$

Let us choose ψ with the form

$$\psi(x, z, t) = \psi_1(t) \cos(\pi z) \sin(qx)$$

According to (147), the components of the speed field are

$$\begin{cases} u = \pi \psi_1(t) \sin(\pi z) \sin(qx) \\ w = q \psi_1(t) \cos(\pi z) \cos(qx) \end{cases}$$

The impulse conservation equation (for equation (145)) for directions x and z becomes

$$\begin{aligned}(u_t + uu_x + ww_z) &= -p_x + \Delta u \\ (w_t + uw_x + ww_z) &= -p_z + \Delta w + \theta\end{aligned}\quad (150a,b)$$

We derive (150 a) according to z and (150) according to x . One finds

$$\begin{aligned} \left[u_{tz} + \frac{\partial}{\partial z}(uu_x + wu_z) \right] &= -p_{xz} + \frac{\partial}{\partial z}(\Delta u) \\ \left[w_{tz} + \frac{\partial}{\partial x}(uw_x + ww_z) \right] &= -p_{zx} + \frac{\partial}{\partial x}(\Delta w) + \frac{\partial \theta}{\partial x} \end{aligned}$$

Through the sum we obtain

$$\left[-(\Delta \Psi)_t + \frac{\partial}{\partial z}(uu_x + wu_z) - \frac{\partial}{\partial x}(uw_x + ww_z) \right] = -\Delta^2 \Psi - \theta_x \quad (151)$$

The value ε being fixed on the two frontiers, we shall have

$$\theta|_{z=\pm 1/2} = 0$$

We consider θ having the form

$$\theta(x, z, t) = \theta_1(t) \cos(\pi z) \cos(qx) + \theta_2(t) \sin(2\pi z) \quad (152)$$

If we consider in (151) the expressions for u , w , θ and ψ it follows that

$$\dot{\psi}_1 = \frac{q\theta_1}{\pi^2 + q^2} - (\pi^2 + q^2)\psi_1 \quad (153)$$

The balance equation for the energy becomes

$$\begin{aligned} \dot{\theta}_1 &= -\pi q \psi_1 \theta_2 + q R \psi_1 - (\pi^2 + q^2) \theta_1 \\ \dot{\theta}_2 &= \frac{1}{2} \pi q \psi_1 \theta_1 - 4\pi^2 \theta_2 \end{aligned} \quad (154)$$

In (153) and (154) we change the variables

$$\begin{aligned} t' &= (\pi^2 + q^2)t; \quad X = \frac{\pi q}{\sqrt{2}(\pi^2 + q^2)} \psi_1 \\ Y &= \frac{\pi q^2}{\sqrt{2}(\pi^2 + q^2)^3} \theta_1; \quad Z = \frac{\pi q^2}{(\pi^2 + q^2)^3} \theta_2 \end{aligned}$$

We obtain the Lorenz type system

$$\begin{aligned} \dot{X} &= (Y - X) \\ \dot{Y} &= -XZ + rX - Y \\ \dot{Z} &= XY - bZ \end{aligned} \quad (155)$$

where

$$r = \frac{q^2}{(\pi^2 + q^2)^3} R, \quad b = \frac{4\pi^2}{\pi^2 + q^2}$$

The Lorenz system

$$\begin{aligned}\dot{X} &= \sigma(Y - X) \\ \dot{Y} &= -XZ + rX - Y \\ \dot{Z} &= XY - bZ\end{aligned}$$

reduces to (155) for $\sigma \equiv 1$.

Characteristics of Lorenz type system. Transitions towards chaos.

We consider the evolution equations of Lorenz type system (155) with the notation

$$\begin{aligned}\dot{x} &= (y - x) \\ \dot{y} &= rx - y - xz \\ \dot{z} &= xy - bz\end{aligned}\tag{156}$$

The system is a dissipative one, since the divergence (for details see (Bărză, A. et al, 2003))

$$\nabla \cdot F = \frac{\partial F_x}{\partial x} + \frac{\partial F_y}{\partial y} + \frac{\partial F_z}{\partial z} = -2 - b < 0$$

since $b > 0$.

Therefore, the phase volume exponentially diminishes in time, as the system tends towards the attractor. For any value of the control parameter r , the system (156) admits as a fixed point the origin

$$x_0 = y_0 = z_0 = 0\tag{157}$$

The characteristic equation is

$$\begin{vmatrix} -1 - \omega & 1 & 0 \\ r - z_0 & -1 - \omega & -x_0 \\ y_0 & x_0 & -b - \omega \end{vmatrix} = 0\tag{158}$$

For the fixed point (157), it takes the form

$$\begin{vmatrix} -1 - \omega & 1 & 0 \\ r & -1 - \omega & 0 \\ 0 & 0 & -b - \omega \end{vmatrix} = 0$$

from where we find

$$(b + \omega)[\omega^2 + 2\omega - (r - 1)] = 0\tag{159}$$

Since parameters b and r are positive ones, it follows that the first eigenvalue $\omega_1 = -b$ is negative for any values of the parameters. The other two eigenvalues ω_2 and ω_3 satisfy the relations

$$\begin{cases} \omega_2 + \omega_3 = -2 < 0 \\ \omega_2 \omega_3 = -(r - 1) \end{cases}\tag{160}$$

According to (160), if $0 < r < 1$ the sum of the two eigenvalues is negative and the product is positive. Therefore, all the eigenvalues are negative and the origin is a stable node. For $r > 1$, according to (160), the origin becomes unstable and two new fixed points appear in a fork bifurcation. These points are noted with C^+ and C^- which corresponds to patterns

$$(C^+) \begin{cases} x_0 = y_0 = \sqrt{b(r-1)} \\ z_0 = r-1 \end{cases}, \quad (C^-) \begin{cases} x_0 = y_0 = -\sqrt{b(r-1)} \\ z_0 = r-1 \end{cases} \quad (161)$$

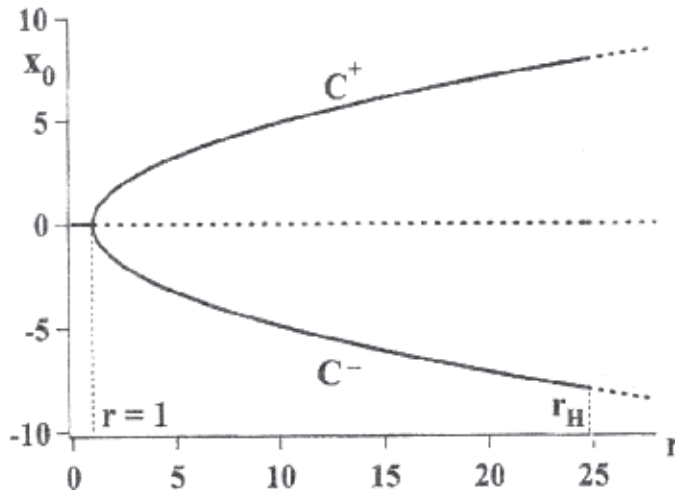

Fig. 1. (according to (Bärzu, A. et al, 2003))

Let us study their stability. Replacing the values that correspond to the branch (C^+) in (158), the characteristic equation becomes

$$\begin{vmatrix} -1-\omega & 1 & 0 \\ 1 & -1-\omega & -\sqrt{b(r-1)} \\ \sqrt{b(r-1)} & \sqrt{b(r-1)} & -b-\omega \end{vmatrix} = 0$$

from where it follows that

$$\omega^3 + \omega^2(b+2) + \omega b(1+r) + 2b(r-1) = 0 \quad (162)$$

If the fixed points (161) will bear a Hopf bifurcation, for a value of control parameter $r_H > 1$, there will be two complex conjugated purely imaginary eigenvalues. Replacing $\omega = i\beta$ in (162) we obtain

$$-i\beta^3 - \beta^2(b+2) + i\beta b(1+r) + 2b(r-1) = 0 \quad (163)$$

Separating the real part from the imaginary one in (163) we obtain the system

$$\begin{aligned} -\beta^3 + \beta b(1+r) &= 0 \\ -\beta^2(b+2) + 2b(r-1) &= 0 \end{aligned} \quad (164a,b)$$

From equation (164a) it follows that $\beta^2 = b(1+r)$. Replacing this value in equation (164), Hopf bifurcation takes place in

$$r_H = -\frac{b+4}{b} \tag{165}$$

Considering that $r_H > 1$ the condition for b results

$$b \leq 4 \tag{166}$$

For this value of the control parameter, the two fixed points C^+ and C^- lose their stability in a subcritical Hopf bifurcation. Beyond the bifurcation point all the periodical orbits are unstable and the system has a chaotic behavior. Figures 2a-c to 8a-c show the trajectories, the time evolutions, the phase portraits and the Fourier transform for the different values of the parameters. It follows that when the value of the parameter r increases, there is a complicated succession of chaotic regimes with certain periodicity windows. The limit cycle appears through a reverse subharmonic cascade and loses stability through intermittent transition towards a new chaotic window.

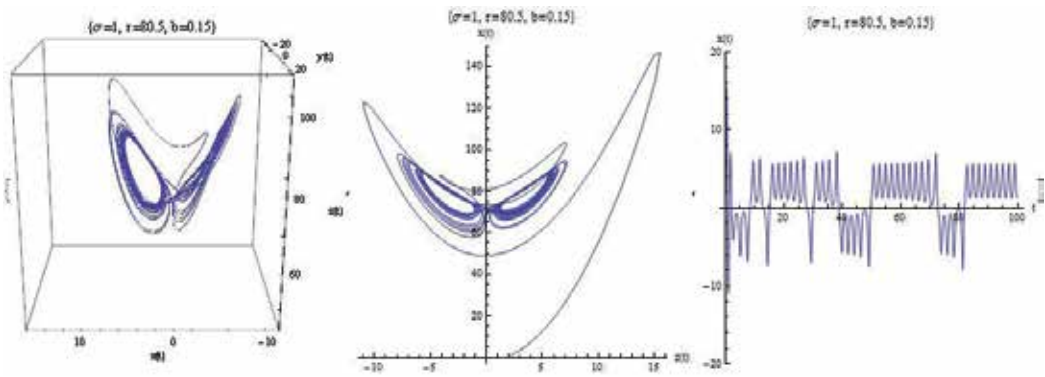

Fig. 2. a) Trajectory b) time evolution c) phase pattern for r=80, b=0.15

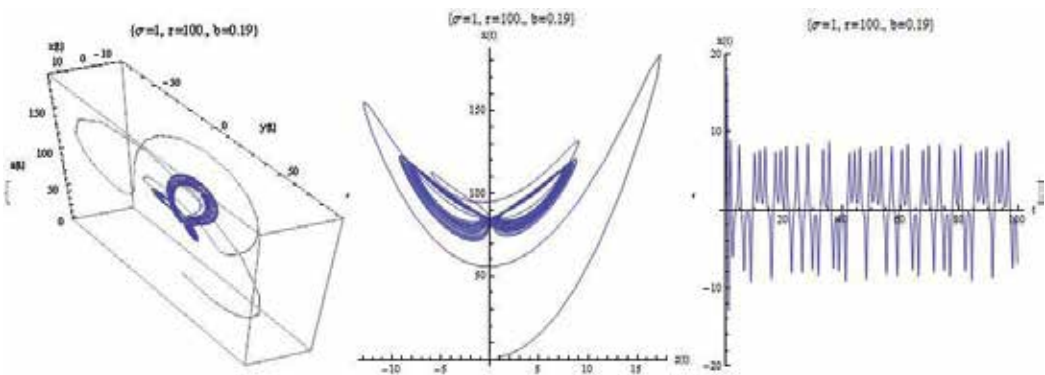

Fig. 3. a) Trajectory b) time evolution c) phase pattern for r=100, b=0.19

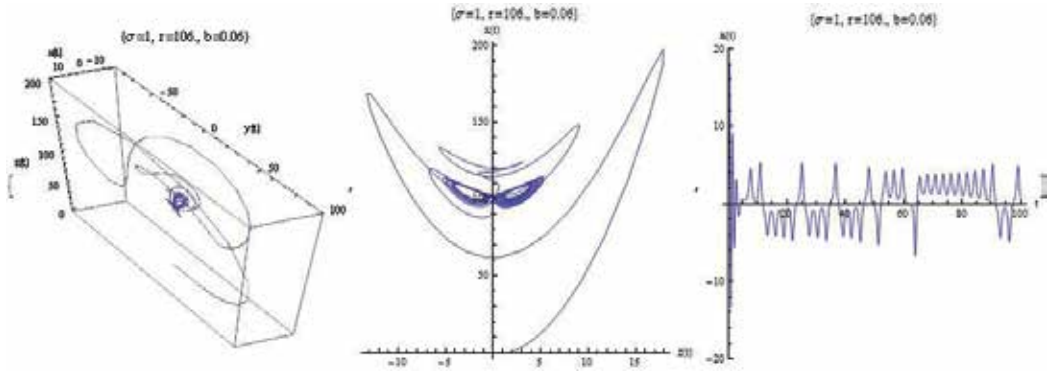

Fig. 4. a) Trajectory b) time evolution c) phase pattern for $r=100$, $b=0.06$

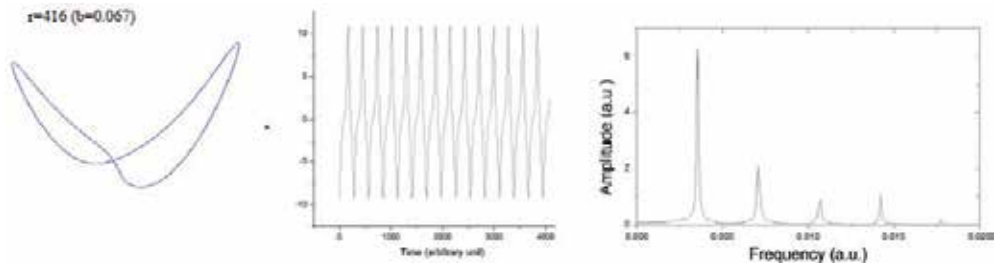

Fig. 5. a) Time evolution b) phase portrait c) the Fourier transform for $r=416$, $b=0.067$

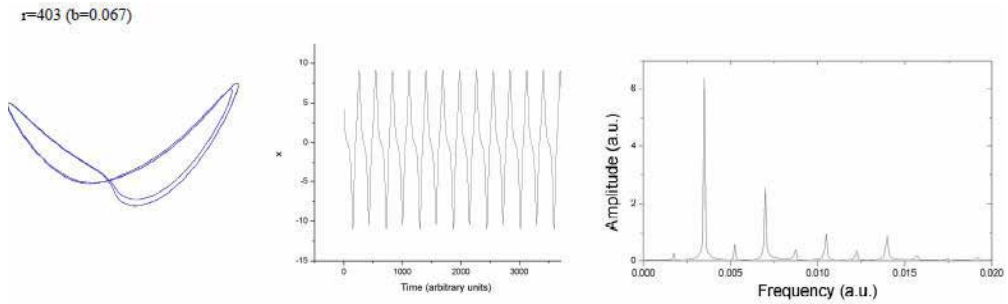

Fig. 6. a) Time evolution b) phase portrait c) the Fourier transform for $r=403$, $b=0.067$

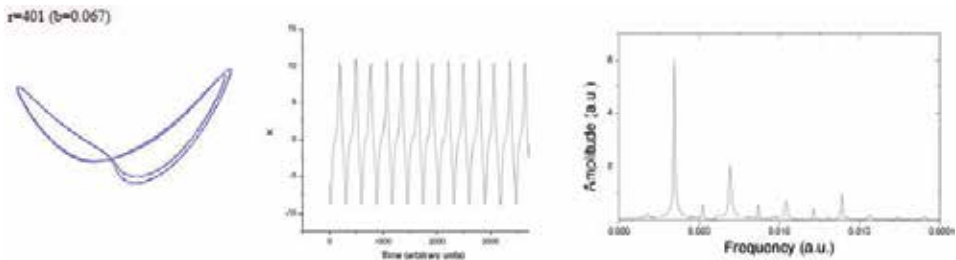

Fig. 7. a) Time evolution b) phase portrait c) the Fourier transform for $r=401$, $b=0.067$

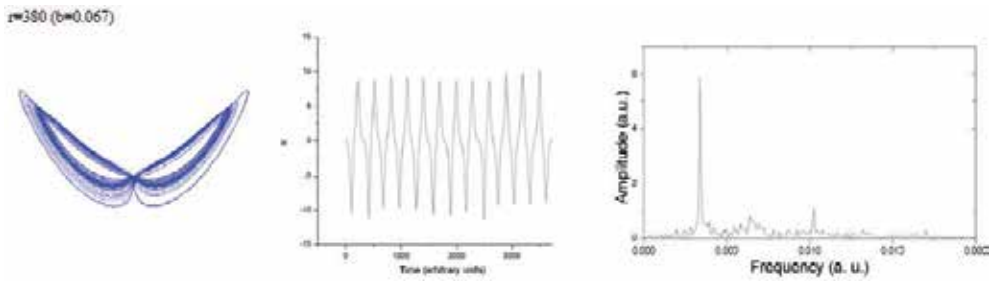

Fig. 8. a) Time evolution b) phase portrait c) the Fourier transform for $r=380$, $b=0.067$

In Fig.9 we present the map of the Lyapunov exponent with the value $\sigma = 1$ (the coordinates of the light points represent the pairs of values $(x,y) = (b,r)$ for which the probability of entering in a chaotic regime is very high).

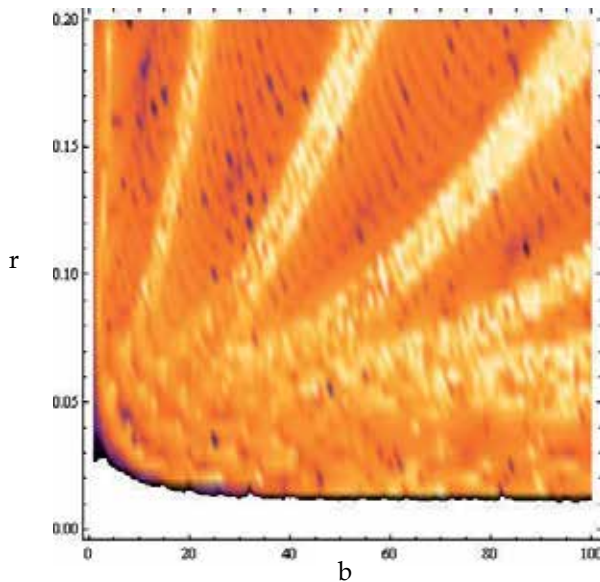

Fig. 9. The Lyapunov exponent map for value $\sigma = 1$ of the Lorenz system

Correspondences with quantum mechanics

The previous analysis states the following:

- i. a model of a physical object can be imagined. This model is built from a Madelung type fluid limited by two carcasses that are submitted to an energy "gradient", from the inferior carcasse towards the superior one;
- ii. for small energy gradients, i.e. $R < R_C$ the reference state is a stable one. The ascending force resulting from energy "dilatation" is much smaller than the dissipative one.
- iii. for energy gradients that impose restriction $R > R_C$ the reference state becomes unstable through the generation of convective type "rolls". The ascensional force is bigger than the dissipative one;
- iv. the increase of energy gradient destroys the convective type "patterns" and induces turbulence;

- v. this behavior of fractal fluid can correspond to a Lorenz type “mechanism”: limit cycles the convective type “rolls”, intermitences (“jumps” between limit cycles) with the “destroy” of the convective type “rolls”, chaos with “turbulence” of the convective type state etc.;
- vi. the stability of solutions corresponds to the dominant undulatory feature, the wave-corpucle duality can be correlated with the Lorenz type mechanism: self-organization of the structure through the generation of convective type “rolls” implies the wave-corpucle transition, while the “jumps” among limit cycles, i.e. the intermitences induce a critical state that corresponds to chaos transition, thus ensuring the dominance of corpucular effect.

15. Conclusions

Finally we can display the conclusions of this chapter as follows:

- a critical analisys of the hydrodinamic model of Madelung and of the double solution theory of de Broglie’s theory of double solution was performed – departing from here, we built a fractal approximation of motion;
- we got the equation of motion of the physical object in the fractal approximation and the Eulerian case was studied;
- the flowing regimes of a rotational fractal fluid were studied;
- we studied the irrotational regime of a fractal fluid and the incorporation of the particle into the associated wave by generating a Schrödinger equation;
- the extended hydrodinamic model of scale relativity was built and the role of the fractal potential in the process of incorporation of the particle into the wave, specified;
- we indicated the mechanisms of wave-particle duality by their in phase coherences;
- we studied the wave-particle duality by stationary flow regimes of a fractal fluid which is coherent in phase, and by non-stationary flow regimes of an incoherent fractal fluid by means of a „polarization” type mechanism;
- considering the particle as a singularity in the wave, we showed that its incorporation into the associated wave resulted in Einstein’s equations in vacuum - contrary, its non-incorporation led to the second quantification;
- we established a relation between the informational energy and the fractal potential of the complex speed field - it resulted that the generation of forces implies the maximum of the information energy principle;
- we showed that a particle model in a fractal approximation of motion induced a Lorenz type mechanism.

16. References

- Agop, M.; Mazilu, N. (1989). *Fundamente ale fizicii moderne*, Ed. Junimea, Iasi
- Agop, M.; Chicoș, L.; Nica, P.; Harabagiu A. (2008). *Euler’s fluids and non-differentiable space-time*, Far East Journal of Dynamical systems 10, 1, 93-106.
- Agop, M.; Harabagiu, A.; Nica, P.(2008). *Wave-Particle duality through a hydrodynamic modul of the fractal space time theory*, Acta physica Polonica A, 113, 6, 1557-1574
- Agop, M.; Colotin, M.; Păun, V. (2009). *Haoticitate, fractalitate și câmpuri*, Elemente de teorie a fractalilor I. Gottlieb și C. Mociuțchi, paginile 12-46, Editura ArsLonga Iași

- Agop, M.; Mazilu, N. (2010). *La răscrucea teoriilor. Între Newton și Einstein – Universul Barbilian*, Ed. Ars Longa, Iași
- Albert D.Z.(1994). *Bohm's alternative to quantum mechanics*. Scientific American, 270:32-39
- Barbilian, D.(1935). *Apolare und Uberpolare Simplexe*, Mathematica (Cluj), Vol. 11, pp.1-24, (retipărit în opera matematică vol I)
- Barbilian, D. (1935). *Die von Einer Quantika Induzierte Riemannsche Metrik*, Comptes rendus de l'Academie Roumaine de Sciences, vol. 2, p.198 (retipărit în Opera Matematica vol. I)
- Barbilian, D. (1938). *Riemannsche Raum Cubischer Binarformen*, Comptes rendus de l'Academie Roumanie des Sciences, vol. 2, pg. 345, (retipărit în Opera Matematica vol. I)
- Barbilian, D. (1971). *Algebră elementară*, în Opera didactică vol II, Ed. Tehnică București
- Barnsley, M. (1988). *Fractals Everywhere. Deterministic Fractal Geometry*, Boston
- Bârzu, A.; Bourceanu, G.; Onel, L. (2003). *Dinamica neliniară*, Editura Matrix-Rom, București
- Bell J.S. (1987). *Speakable and unspeakable in quantum mechanics*. Cambridge University Press, Cambridge
- Benoit Deveand Ed., (2007) *Physics of Semiconductor microcavities from fundamentals to nano-scale decretes*, Wiley-VCH Verlag GmbH Weinheim Germany
- Berge, P. ; Pomeau Y. & Vidal Ch.(1984). *L'Ordre dans le chaos*, Hermann
- Berndl K.; Dörr D.; Goldstein S.; Peruzzi G. and Zanchi N. (1993) *Existance of Trajectories for Bohmian Mechanics*. International Journal of Theoretical Physics, 32: 2245-2251
- Berndl K.; Dörr D.; Goldstein S. and Zanchi N.(1994). *Selfadjointness and the Existance of Deterministic Trajectories in Quantum Theory*, In On three Levels: Micro-, Meso-, and Macroscopic Approches in Physics, (NATO ASI Series B: Physics, Volume 324, Plenum, New-York) pp. 429-434
- Bittner E.R.,(2000). *Quantum Tunneling dynamics using hydrodynamic trajectories*, Journal of Chiminal - Physics, 112, 9703
- Bohm, D. (1952). *A Suggested Interpretation of Quantum Theory in Terms of „Hidden” Variables I*, Phys. Rev. 85 166-179
- Bohm D.; Hiley B.J. (1993). *The Undivided Universe: An Ontological Interpretation of Quantum Theory*. Routledge and Kegan Paul, London.
- Bohm D. (1952). *A suggested interpretation of quantum theory in terms of „hidden variables”: Part II*. Physical Review, 85: 180-193
- Bohm D. (1953). *Proof that probability density approaches $|\psi^2|$ in causal interpretation of quantum theory*, Physical Review, 89: 458-466
- de Broglie L.(1956). *Un tentative d'interprétation causale et non linéaire de la Mécanique ondulatoire: la theorie de la double solution*, Gauthier-Villars, Paris
- de Broglie L. (1957). *La theoree de la Mesure on Mécanique ondulatoire*, Gauthier-Villars, Paris
- de Broglie L. (1959). *L'interprétation de la Mécanique ondulatoire*, J. Phys. Rad, 20, 963
- de Broglie L. (1963). *Étude critique des bases de l'interprétation actuelle de la Mécanique ondulatoire*, Gauthier-Villars, Paris
- de Broglie L. (1964). *La Thermodynamique de la particule isolée (Thermodynamique cachée des particules)*, Gauthier-Villars, Paris
- de Broglie L. (1980). *Certitudinile și incertitudinile științei*, Editura Politică, București
- Budei, L. (2000). *Modele cu fractali. Aplicații în arhitectura mediului*, Editura Univ. "Gh. Asachi", Iași

- Chaline, J.; Nottale, L. ; Grou, P. (2000). *Les arbres d'évolution: Univers S, Vie, Societes*, Edition Hachette
- Chaline, J. ; Nottale, L. ; Grou, P. (2009). *Des fleurs pour Schrödinger: La relativité d'échelle et ses applications* Editura Ellipses Marketing
- Chioroiu, V. ; Munteanu, L. ; Ştiucă, P. ; Donescu, Ş. (2005). *Introducere în nanomecanică*, Editura Academiei Române, Bucureşti
- Ciuti C. ; Camsotto I. (2005). *Quantum fluids effects and parametric instabilities in microcavities*, Physica Status Solidi B, 242, 11, 2224
- Dörr D. ; Goldstein S. ; Zanghi N. (1992). *Quantum Mechanics, Randomness and deterministic Reality*. Physics Letters A, 172 : 6-12
- Dörr D.; Goldstein S. and Zanchi N. (1993). *A Global Equilibrium as the Foundation of Quantum Randomness*, Foundations of Physics, 23: 712-738
- Ernst, F.J. (1968). *New formulation of the Axially Symmetric Gravitational Field Problem I*, Phys Rev. 167, 1175, *New formulation of the Axially Symmetric Gravitational Field Problem II*, Phys Rev. 168, p.1415
- Ernst, F.J. (1971). *Exterior Algebraic Derivation of Einstein Field Equation Employing a Generalized Basis*, J. Math. Phys. , 12, 2395
- Feder, J. & Aharony, A. (Eds) (1990). *Fractals in Physics* North - Holland, Amsterdam
- Felsager, B. (1981). *Geometry, Particles and fields*. Odense Univ. Press
- Ferry, D. K.; Goodnick, S. M. (2001). *Transport in Nanostructures*, Cambridge University Press
- Gouyet JF. (1992). *Physique et Structures Fractals*, Masson Paris
- Green, M. B.; Schwarz, J. H.; Witten, E. (1998). *Superstring Theory* vol I, II. Cambridge University, Press, Cambridge
- Grössing G. (2008). *Diffusion waves in sub-quantum thermodynamics: Resolution of Einstein's "Particle-in-a-box" objection*, (in press) <http://arxiv.org/abs/0806.4462>
- Halbwachs, F. (1960). *Theorie relativiste des fluids a spin*, Gauthier-Villars, Paris
- Harabagiu, A.; Agop, M. (2005). *Hydrodynamic model of scale relativity theory*, Buletinul Institutului Politehnic Iaşi, tomul LI (LV) Fasc. 3-4, 77-82, secţia Matematică, Mecanică teoretică, Fizică
- Harabagiu, A.; Niculescu, O.; Colotin, M.; Bibere, T. D.; Gottlieb, I.; Agop, M. (2009). *Particle in a box by means of fractal hydrodynamic model*, Romanian Reports in Physics, 61, 3, 395-400
- Harabagiu A. ; Magop, D. ; Agop, M. (2010). *Fractalitate şi mecanică cuantică*, Editura Ars Longa Iaşi
- Heck, A. & Perdang, JM. (Eds) (1991). *Applying Fractals in Astronomy*; Springer Verlag
- Holland P.R. (1993). *The Quantum Theory of Motion*. Cambridge University Press, Cambridge
- Imry, Y. (2002). *Introduction to Mesoscopic Physics*, Oxford University Press, Oxford
- Madelung R. (1927). Zs f. Phys.40, 322
- Mandelis A.; Nicolaides L.; Chen Y. (2001). *Structure and the reflectionless/refractionless nature of parabolic diffusion-wave fields*, Phys. Rev. Lett. 87, 020801
- Mandelis A. (2000). *Diffusion waves and their uses*, Phys. Today 53, 29
- Mazilu N.; Agop M. (1994). *Fizica procesului de măsură*, Ed. Ştefan Procopiu, Iaşi
- Le Mehante A. (1990). *Les Geometries Fractales*, Hermes, Paris
- Mihăileanu, N. (1972). *Geometrie analitică, proiectivă şi diferenţială*, Complementary Editura Didactică şi Pedagogică, Bucureşti

- Munceanu, C.V.; Magop D.; Marin C. ; Agop, M (2010). *Modele fractale în fizica polimerilor*, Ars Longa
- El Naschie, MS ; Rössler, OE ; Prigogine, I. (Eds.) (1995) *Quantum mechanics, diffusion and chaotic fractals*, Oxford: Elsevier
- Nelson, E. (1985). *Quantum Fluctuations*, Princeton University Press, Princeton, New York
- Nottale, L.; Schneider J. (1984). *Fractals and non-standard analysis*; J. Math. Phys. 25,12, 96-300
- Nottale, L. (1989). *Fractals and the quantum theory of space-time* Int. J. Mod. Phys. A4 50 47-117
- Nottale, L. (1993). *Fractal Space-Time and Microphysics. Towards a Theory of Scale Relativity*, World Scientific
- Nottale, L. (1996). *Scale relativity and fractal space-time: Applications to quantum physics, cosmology and chaotic systems*. Chaos, Solitons & Fractals 7 :877
- Nottale, L. (2004). *The theory of scale relativity: Nondifferentiable geometry, Fractal space-time and Quantum Mechanics*, Computing Anticipatory systems: CASYS' 03-33 Sixth International Conference, AIP Conference Proceedings vol 718, pag. 68-95
- Peres, A. (1993). *Quantum theory: Concepts and methods*, Kluwer Acad. Publ., Boston
- Poole, C. P.; Farach, K. A.; Creswick, R. (1995). *Superconductivity*, San Diego, Academic Press
- Popescu, S. (2004). *Probleme actuale ale fizicii sistemelor autoorganizate*, Editura Tehnopress, Iasi
- Ruelle D.; Takens, F. (1971). *On the Nature of Turbulence*, Commun. Math. Phys., 20, 167, 23, 343
- Ruelle, D. (1975). *Strange Attractors*, The mathematical Intelligencer 2, 126
- Sakurai J.J.; San Fu Taun (1994). *Modern Quantum Mechanics*, Addison-Wesley, Reading, MA
- Țițeica, S. (1984). *Mecanică cuantică*, Editura Academiei, București
- Weibel, P.; Ord G.; Rössler, OE (Eds) (2005). *Space time physics and fractality*, Festschrift in honor of Mohamad El Naschie Vienna, New York: Springer

Approximate Solutions of the Dirac Equation for the Rosen-Morse Potential in the Presence of the Spin-Orbit and Pseudo-Orbit Centrifugal Terms

Kayode John Oyewumi

*Theoretical Physics Section, Physics Department,
University of Ilorin, Ilorin
Nigeria*

1. Introduction

In quantum mechanics, it is well known that the exact solutions play fundamental role, this is because, these solutions usually contain all the necessary information about the quantum mechanical model under investigation. In recent years, there has been a renewed interest in obtaining the solutions of the Dirac equations for some typical potentials under special cases of spin symmetry and pseudo-spin symmetry (Arima et al., 1969; Hecht and Adler, 1969).

The idea about spin symmetry and pseudo-spin symmetry with the nuclear shell model has been introduced in 1969 by Arima et al. (1969) & Hecht and Adler (1969). This idea has been widely used in explaining a number of phenomena in nuclear physics and related areas. Spin and pseudo-spin symmetric concepts have been used in the studies of certain aspects of deformed and exotic nuclei (Meng & Ring, 1996; Ginocchio, 1997; Ginocchio & Madland, 1998; Alberto et al., 2001; 2002; Lisboa et al., 2004a; 2004b; 2004c; Guo et al., 2005a; 2005b; Guo & Fang, 2006; Ginocchio, 2004; Ginocchio, 2005a; 2005b).

Spin symmetry (SS) is relevant to meson with one heavy quark, which is being used to explain the absence of quark spin orbit splitting (spin doublets) observed in heavy-light quark mesons (Page et al., 2001). On the other hand, pseudo-spin symmetry (PSS) concept has been successfully used to explain different phenomena in nuclear structure including deformation, superdeformation, identical bands, exotic nuclei and degeneracies of some shell model orbitals in nuclei (pseudo-spin doublets)(Arima, et al., 1969; Hecht & Adler, 1969; Meng & Ring, 1996; Ginocchio, 1997; Troltenier et al., 1994; Meng, et al., 1999; Stuchbery, 1999; 2002). Within this framework also, Ginocchio deduced that a Dirac Hamiltonian with scalar $S(r)$ and vector $V(r)$ harmonic oscillator potentials when $V(r) = S(r)$ possesses a spin symmetry (SS) as well as a $U(3)$ symmetry, whereas a Dirac Hamiltonian for the case of $V(r) + S(r) = 0$ or $V(r) = -S(r)$ possesses a pseudo-spin symmetry and a pseudo- $U(3)$ symmetry (Ginocchio, 1997; 2004; 2005a; 2005b). As introduced in nuclear theory, the PSS refers to a quasi-degeneracy of the single-nucleon doublets which can be characterized with the non-relativistic quantum mechanics $(n, \ell, j = \ell + \frac{1}{2})$ and $(n - 1, \ell + 2, j = \ell + \frac{3}{2})$, where n, ℓ and j are the single-nucleon radial, orbital and total angular momentum quantum numbers for a single particle, respectively (Arima et al., 1969; Hecht & Adler, 1969; Ginocchio, 2004;

2005a; 2005b; Page et al., 2001). The total angular momentum is given as $j = \bar{\ell} + \bar{s}$, where $\bar{\ell} = \ell + 1$ is a pseudo- angular momentum and $\bar{s} = \frac{1}{2}$ is a pseudo-spin angular momentum.

Meng et al., (1998) deduced that in real nuclei, the PSS is only an approximation and the quality of approximation depends on the pseudo-centrifugal potential and pseudo-spin orbital potential. The orbital and pseudo-orbital angular momentum quantum numbers for SS ℓ and PSS $\bar{\ell}$ refer to the upper-and lower-spinor components (for instance, $F_{n,\kappa}(r)$ and $G_{n,\kappa}(r)$, respectively).

Ginocchio (1997); (1999); (2004); (2005a); (2005b) and Meng et al., (1998) showed that SS occurs when the difference between the vector potential $V(r)$ and scalar potential $S(r)$ in the Dirac Hamiltonian is a constant (that is, $\Delta(r) = V(r) - S(r)$) and PSS occurs when the sum of two potential is a constant (that is, $\Sigma(r) = V(r) + S(r)$).

A large number of investigations have been carried out on the SS and PSS by solving the Dirac equation with various methods (Alberto et al., 2001; 2002; Lisboa et al., 2004a; 2004b; 2004c; Ginocchio, 2005a; 2005b; Xu et al., 2008; Guo et al., 2005a; 2005b; de Castro et al., 2006; Wei and Dong, 2009; Zhang, 2009; Zhang et al., 2009a; Setare & Nazari, 2009; Ginocchio, 1999; Soylyu et al., 2007; 2008a; 2008b; Berkdemir, 2006; 2009; Berkdemir & Sever, 2009; Xu & Zhu, 2006; Jia et al., 2006; Zhang et al., 2009a; Zhang et al., 2008; Aydoğdu, 2009; Aydoğdu & Sever, 2009; Wei and Dong, 2008; Jia et al., 2009a; 2009b; Guo et al., 2007).

Some of these potentials are exactly solvable, these include: harmonic potential (Lisboa et al., 2004a; 2004b; 2004c; Ginocchio, 1999; 2005a; 2005b; Guo et al., 2005a; 2005b; de Castro et al., 2006; Akcay & Tezcan, 2009), Coulomb potential (Akcay, 2007; 2009), pseudoharmonic potential (Aydoğdu, 2009; Aydoğdu & Sever, 2009; Aydoğdu & Sever, 2010a), Mie-type potential (Aydoğdu, 2009; Aydoğdu & Sever, 2010b).

Also, for the \bar{s} -wave with zero pseudo-orbital angular momentum $\bar{\ell} = 0$ and spin-orbit quantum number $\kappa = 1$, exact analytical solutions have been obtained for some potentials with different methods, such as: Woods-Saxon potential (Aydoğdu, 2009; Guo & Sheng, 2005; Aydoğdu & Sever, 2010c), Eckart potential (Jia et al., 2006), Pöschl-Teller potential (Jia et al., 2009b), Rosen-Morse potential (Oyewumi & Akoshile, 2010), trigonometric Scarf potential (Wei et al., 2010).

However, exact analytical solution for any ℓ - states are possible only in a few instances. it is important to mention that most of these potentials can not be solved exactly for $\ell \neq 1$ ($\kappa \neq -1$) or $\bar{\ell} \neq 0$ ($\kappa \neq 1$) state, hence, a kind of approximation to the (pseudo or) - centrifugal term is necessary (Pekeris-type approximation) (Ikhdair, 2010; 2011; Ikhdair et al., 2011; Xu et al., 2008; Jia et al., 2009a; 2009b; Wei and Dong, 2009; Zhang et al., 2009b; Soylyu et al., 2007; 2008a; 2008b; Zhang et al., 2008; Aydoğdu and Sever, 2010c; Aydoğdu and Sever, 2010d; Bayrak and Boztosun, 2007; Pekeris, 1934; Greene and Aldrich, 1976; Wei and Dong, 2010a; 2010b; 2010c). With this kind of approximation to the (pseudo or) - centrifugal term, the SS and PSS problems have been solved using different methods to obtain the approximate solutions: AIM (Soylyu et al., 2007; 2008a; 2008b; Aydoğdu & Sever, 2010c; Bayrak & Boztosun, 2007; Hamzavi et al., 2010c), Nikiforov- Uvarov method (Aydoğdu & Sever, 2010c; Hamzavi et al., 2010a; 2010b; Berkdemir, 2006; 2009; Berkdemir & Sever, 2009; Ikhdair, 2010; 2011; Ikhdair et al., 2011), functional analysis method (Xu et al., 2008; Wei & Dong, 2010d), SUSY and functional analysis (Jia et al., 2006; 2009a; 2009b; Wei & Dong, 2009; Zhang et al., 2009b; Setare & Nazari, 2009; Wei & Dong, 2010a; 2010b; 2010c). Therefore, by applying a Pekeris-type approximation to the (pseudo or) - centrifugal-like term, the relativistic bound state solutions can be obtained in the framework of the PSS and SS concepts.

In this study, the Rosen-Morse potential is considered, due to the important applications of in atomic, chemical and molecular Physics as well (Rosen & Morse, 1932). This potential is very useful in describing interatomic interaction of the linear molecules. The Rosen-Morse potential is given as

$$V(r) = -V_1 \operatorname{sech}^2 \alpha r + V_2 \tanh \alpha r, \tag{1}$$

where V_1 and V_2 are the depth of the potential and α is the range of the potential, respectively. Thus, our aim is to employ the newly improved approximation scheme (or Pekeris-type approximation scheme) in order to obtain the PSS and SS solutions of the Dirac equations for the Rosen-Morse potential with the centrifugal term. This potential has been studied by various researchers in different applications (Rosen & Morse, 1932; Yi et al., 2004; Taşkin, 2009; Oyewumi & Akoshile and reference therein, 2010; Ikhdair, 2010; Ibrahim et al., 2011; Amani et al., 2011). In the light of this study, standard function analysis approach will be used (Yi et al, 2004; Taşkin, 2009).

In this chapter, Section 2 contains, the basic equations for the upper- and lower- component of the Dirac spinors. In Section 3, the approximate analytical solutions of the Dirac equation with the Rosen-Morse potential with arbitrary κ under pseudospin and spin symmetry conditions are obtained by means of the standard function analysis approach. Also, the solutions of some special cases are obtained. The bound state solutions of the relativistic equations (Klein-Gordon and Dirac) with the equally mixed Rosen-Morse potentials for any ℓ or κ are contained in Section 4. Section 5 contains contains the conclusions.

2. Basic Equations for the upper- and lower-components of the Dirac spinors

In the case of spherically symmetric potential, the Dirac equation for fermionic massive spin- $\frac{1}{2}$ particles interacting with the arbitrary scalar potential $S(r)$ and the time-component $V(r)$ of a four-vector potential can be expressed as (Greiner, 2000; Wei & Dong, 2009; 2010a; 2010b; 2010c; 2010d; Ikhdair, 2010; 2011; Oyewumi & Akoshile, 2010; Ikhdair et al., 2011):

$$\left[c\vec{\alpha} \cdot \vec{P} + \beta [Mc^2 + S(\vec{r})] + V(\vec{r}) - E \right] \psi_{n\kappa}(\vec{r}) = 0, \tag{2}$$

where E is the relativistic energy of the system, M is the mass of a particle, $\vec{P} = -i\hbar\nabla$ is the momentum operator. $\vec{\alpha}$ and β are 4×4 Dirac matrices, given as

$$\vec{\alpha} = \begin{pmatrix} 0 & \sigma_i \\ \sigma_i & 0 \end{pmatrix}, \quad \beta = \begin{pmatrix} \mathbf{I} & 0 \\ 0 & -\mathbf{I} \end{pmatrix}, \tag{3}$$

where \mathbf{I} is the 2×2 identity matrix and $\sigma_i (i = 1, 2, 3)$ are the vector Pauli matrices.

Following the procedure stated in (Greiner, 2000; Wei & Dong 2009; 2010a; 2010b; 2010c; 2010d; Ikhdair, 2010; 2011; Ikhdair et al., 2011), the spinor wave functions can be written using the Pauli-Dirac representation as:

$$\psi_{n\kappa}(\vec{r}) = \frac{1}{r} \begin{bmatrix} F_{n\kappa}(r) Y_{jm}^\ell(\theta, \phi) \\ iG_{n\kappa}(r) Y_{jm}^{\bar{\ell}}(\theta, \phi) \end{bmatrix}; \quad \kappa = \pm(j + \frac{1}{2}), \tag{4}$$

where $F_{n\kappa}(r)$ and $G_{n\kappa}(r)$ are the radial wave functions of the upper and lower spinors components, respectively. $Y_{jm}^\ell(\theta, \phi)$ and $Y_{jm}^{\bar{\ell}}$ are the spherical harmonic functions coupled

to the total angular momentum j and its projection m on the z -axis. The orbital and pseudo-orbital angular momentum quantum numbers for SS (ℓ) and PSS ($\bar{\ell}$) refer to the upper ($F_{n\kappa}(r)$) and lower ($G_{n\kappa}(r)$) spinor components, respectively, for which $\ell(\ell + 1) = \kappa(\kappa + 1)$ and $\bar{\ell}(\bar{\ell} + 1) = \kappa(\kappa - 1)$. For the relationship between the quantum number κ to the quantum numbers for SS (ℓ) and PSS ($\bar{\ell}$) (Ikhdair, 2010; 2011; Ikhdair et al., 2011; Jia et al., 2009a; 2009b; Xu et al., 2008; Wei & Dong, 2009; Ginocchio, 2004; Zhang et al., 2009b; Setare & Nazari, 2009). For comprehensive reviews, see Ginocchio (1997) and (2005b).

On substituting equation (4) into equation (2), the two-coupled second-order ordinary differential equations for the upper and lower components of the Dirac wave function are obtained as follows:

$$\left(\frac{d}{dr} + \frac{\kappa}{r}\right) F_{n\kappa}(r) = [Mc^2 + E_{n\kappa} - \Delta(r)] G_{n\kappa}, \quad (5)$$

$$\left(\frac{d}{dr} - \frac{\kappa}{r}\right) G_{n\kappa}(r) = [Mc^2 - E_{n\kappa} + \Sigma(r)] F_{n\kappa}. \quad (6)$$

Eliminating $F_{n\kappa}(r)$ and $G_{n\kappa}(r)$ from equations (5) and (6), the following two Schrödinger-like differential equations for the upper and lower radial spinors components are obtained, respectively as:

$$\left\{ -\frac{d^2}{dr^2} + \frac{\kappa(\kappa + 1)}{r^2} + \frac{1}{\hbar^2 c^2} [Mc^2 + E_{n\kappa} - \Delta(r)] [Mc^2 - E_{n\kappa} + \Sigma(r)] \right\} F_{n\kappa}(r) \\ = \frac{\frac{d\Delta(r)}{dr} \left(\frac{d}{dr} + \frac{\kappa}{r}\right)}{[Mc^2 + E_{n\kappa} - \Delta(r)]} F_{n\kappa}(r), \quad (7)$$

$$\left\{ -\frac{d^2}{dr^2} + \frac{\kappa(\kappa - 1)}{r^2} + \frac{1}{\hbar^2 c^2} [Mc^2 + E_{n\kappa} - \Delta(r)] [Mc^2 - E_{n\kappa} + \Sigma(r)] \right\} G_{n\kappa}(r) \\ = -\frac{\frac{d\Sigma(r)}{dr} \left(\frac{d}{dr} - \frac{\kappa}{r}\right)}{[Mc^2 - E_{n\kappa} + \Sigma(r)]} G_{n\kappa}(r), \quad (8)$$

where $\Delta(r) = V(r) - S(r)$ and $\Sigma(r) = V(r) + S(r)$ are the difference and the sum of the potentials $V(r)$ and $S(r)$, respectively.

In the presence of the SS, that is, the difference potential $\Delta(r) = V(r) - S(r) = C_s =$ constant or $\frac{d\Delta(r)}{dr} = 0$, then, equation (7) reduces into

$$\left\{ -\frac{d^2}{dr^2} + \frac{\kappa(\kappa + 1)}{r^2} + \frac{1}{\hbar^2 c^2} [Mc^2 + E_{n\kappa} - C_s] \Sigma(r) \right\} F_{n\kappa}(r) \\ = [E_{n\kappa}^2 - M^2 c^4 + C_s (Mc^2 - E_{n\kappa})] F_{n\kappa}(r), \quad (9)$$

where $\kappa(\kappa + 1) = \ell(\ell + 1)$, $\kappa = \begin{cases} \ell, & \text{for } \kappa < 0 \\ -(\ell + 1), & \text{for } \kappa > 0 \end{cases}$. The SS energy eigenvalues depend on n and κ , for $\ell \neq 0$, the states with $j = \ell \pm \frac{1}{2}$ are degenerate. Then, the lower component

$G_{n\kappa}(r)$ of the Dirac spinor is obtained as

$$G_{n,\kappa}(r) = \frac{1}{Mc^2 + E_{n\kappa} - C_s} \left[\frac{d}{dr} + \frac{\kappa}{r} \right] F_{n\kappa}(r), \quad (10)$$

where $E_{n\kappa} + Mc^2 \neq 0$, only real positive energy state exist when $C_s = 0$ (Guo & Sheng, 2005; Ikhdaïr, 2010; Ikhdaïr et al., 2011).

Also, under the PSS condition, that is, the sum potential $\Sigma(r) = V(r) + S(r) = C_{ps}$ constant or $\frac{d\Sigma(r)}{dr} = 0$, then, equation (7) becomes

$$\begin{aligned} & \left\{ -\frac{d^2}{dr^2} + \frac{\kappa(\kappa - 1)}{r^2} - \frac{1}{\hbar^2 c^2} [Mc^2 - E_{n\kappa} + C_{ps}] \Delta(r) \right\} G_{n\kappa}(r) \\ & = [E_{n\kappa}^2 - M^2 c^4 + C_{ps}(Mc^2 - E_{n\kappa})] G_{n\kappa}(r), \end{aligned} \quad (11)$$

and the upper component $F_{n\kappa}(r)$ is obtained as

$$F_{n,\kappa}(r) = \frac{1}{Mc^2 - E_{n\kappa} + C_{ps}} \left[\frac{d}{dr} - \frac{\kappa}{r} \right] G_{n\kappa}(r), \quad (12)$$

where $E_{n\kappa} - Mc^2 \neq 0$, only real negative energy state exist when $C_{ps} = 0$. Also, κ is related to the pseudo-orbital angular quantum number $\bar{\ell}$ as $\kappa(\kappa - 1) = \bar{\ell}(\bar{\ell} + 1)$, $\kappa = \begin{cases} -\bar{\ell}, & \text{for } \kappa < 0 \\ (\bar{\ell} + 1), & \text{for } \kappa > 0 \end{cases}$, which implies that $j = \bar{\ell} \pm \frac{1}{2}$ are degenerate for $\bar{\ell} \neq 0$ (Guo & Sheng, 2005; Ikhdaïr, 2010; Ikhdaïr et al., 2011). It is required that the upper and lower spinor components must satisfy the following boundary conditions $F_{n\kappa}(0) = G_{n\kappa}(0) = 0$ and $F_{n\kappa}(\infty) = G_{n\kappa}(\infty) = 0$ for bound state solutions.

Exact solutions of equations (9) and (11) with the Rosen-Morse potential (1) can be obtained only for the s -wave ($\kappa = 0, -1$) and ($\kappa = 0, 1$) due to the spin-orbit (or pseudo) centrifugal term $\frac{\kappa(\kappa+1)}{r^2}$ (or $\frac{\kappa(\kappa-1)}{r^2}$). Therefore, a newly improved approximation in dealing with the spin-orbit (or pseudo) centrifugal term to obtain the approximate solutions for the Rosen-Morse is adopted.

This type of approximation, (Pekeris-type) approximation can be traced back to Pekeris (1934), and for short-range potential, Greene & Aldrich (1976) proposed a good approximation to the centrifugal term ($1/r^2$). The idea about the use of approximation to centrifugal (or pseudo centrifugal) term has received much attention and considerable interest due to its wide range of applications (Wei & Dong, 2010a; 2010b; 2010c; 2010d; Aydoğdu & Sever, 2010; Zhang et al., 2009b; Jia et al., 2009a; 2009b; Lu, 2005; Ikhdaïr, 2010; Ikhdaïr et al., 2011). We adopt the centrifugal (or pseudo centrifugal) approximation introduced by Lu (2005) for values of κ that are not large and vibrations of the small amplitude about the minimum. This approximation to the centrifugal or (pseudo centrifugal) term near the minimum point $r = r_0$ introduced by Lu (2005) is given as follows:

$$\frac{1}{r^2} \approx \frac{1}{r_0^2} \left[c_0 + c_1 \left(\frac{-e^{-2\alpha r}}{1 + e^{-2\alpha r}} \right) + c_2 \left(\frac{-e^{-2\alpha r}}{1 + e^{-2\alpha r}} \right)^2 \right], \quad (13)$$

where

$$\begin{aligned} C_0 &= 1 - \left(\frac{1 + e^{-2\alpha r_0}}{2\alpha r_0} \right)^2 \left(\frac{8\alpha r_0}{1 + e^{-2\alpha r_0}} - (3 + 2\alpha r_0) \right), \\ C_1 &= -2(e^{2\alpha r_0} + 1) \left[3 \left(\frac{1 + e^{-2\alpha r_0}}{2\alpha r_0} \right) - (3 + 2\alpha r_0) \left(\frac{1 + e^{-2\alpha r_0}}{2\alpha r_0} \right) \right], \\ C_2 &= (e^{2\alpha r_0} + 1)^2 \left(\frac{1 + e^{-2\alpha r_0}}{2\alpha r_0} \right)^2 \left[(3 + 2\alpha r_0) - \left(\frac{4\alpha r_0}{1 + e^{-2\alpha r_0}} \right) \right], \end{aligned} \quad (14)$$

other higher terms are neglected.

3. Bound state solutions of the Dirac equation with the Rosen-Morse potential with arbitrary κ

3.1 Spin symmetry solutions of the Dirac equation with the Rosen-Morse potential with arbitrary κ

In equation (9), we adopt the choice of $\Sigma(r) = 2V(r) \rightarrow V(r)$ as earlier illustrated by Alhaidari et al. (2006), which enables us to reduce the resulting solutions into their non-relativistic limits under appropriate transformations, that is,

$$\Sigma(r) = -4V_1 \frac{e^{-2\alpha r}}{(1 + e^{-2\alpha r})^2} + V_2 \frac{(1 - e^{-2\alpha r})}{(1 + e^{-2\alpha r})}. \quad (15)$$

Using the centrifugal term approximation in equation (13) and introducing a new variable of the form $z = e^{-2\alpha r}$ in equation (9), the following equation for the upper component spinor $F_{n\kappa}(r)$ is obtained as:

$$\begin{aligned} z^2 \frac{d^2}{dz^2} F_{n\kappa}(z) + z \frac{d}{dz} F_{n\kappa}(z) + \frac{1}{4\alpha^2} \left\{ \frac{1}{\hbar^2 c^2} [E_{n\kappa}^2 - M^2 c^4 + C_s (Mc^2 - E_{n\kappa})] \right\} F_{n\kappa}(z) \\ - \frac{\kappa(\kappa + 1)}{4\alpha^2} \left\{ \frac{1}{r_0^2} \left[C_0 + C_1 \frac{z}{1-z} + C_2 \frac{z^2}{(1-z)^2} \right] - \frac{4\tilde{V}_1 z}{(1-z)^2} - \tilde{V}_2 - \frac{2\tilde{V}_2 z}{(1-z)} \right\} F_{n\kappa}(z), \end{aligned} \quad (16)$$

where

$$\tilde{V}_1 = \frac{V_1}{\hbar^2 c^2} [Mc^2 + E_{n\kappa} - C_s] \text{ and } \tilde{V}_2 = \frac{V_2}{\hbar^2 c^2} [Mc^2 + E_{n\kappa} - C_s]. \quad (17)$$

The upper component spinor $F_{n\kappa}(z)$ has to satisfy the boundary conditions, $F_{n\kappa}(z) = 0$ at $z \rightarrow 0$ ($r \rightarrow \infty$) and $F_{n\kappa}(z) = 1$ at $z \rightarrow 1$ ($r \rightarrow 0$). Then, the function $F_{n\kappa}(z)$ can be written as

$$F_{n\kappa}(z) = (1 - z)^{1+q} z^\beta f_{n\kappa}(z), \quad (18)$$

where

$$q = \frac{1}{2} \left[-1 + \sqrt{1 + \frac{\kappa(\kappa + 1)C_2}{\alpha^2 r_0^2} + \frac{4\tilde{V}_1}{\alpha^2}} \right] \quad (19)$$

and

$$-\beta^2 = \frac{1}{4\alpha^2} \left\{ \frac{1}{\hbar^2 c^2} [E_{n\kappa}^2 - M^2 c^4 + C_s (Mc^2 - E_{n\kappa})] - \frac{\kappa(\kappa + 1)}{r_0^2} C_0 - \tilde{V}_2 \right\}. \quad (20)$$

On substituting equation (18) into equation (16) with equations (17), (19) and (20) , the second-order differential equation is obtained as

$$z(1-z)\frac{d^2}{dz^2}f_{n\kappa}(z) + [(2\beta + 1) - (2q + 2\beta + 3)z]\frac{d}{dz}f_{n\kappa}(z) - \left[(2\beta + 1)(1 + q) + \frac{\tilde{V}_2 + 2\tilde{V}_1}{2\alpha^2} + \frac{\kappa(\kappa + 1)C_1}{4\alpha^2r_0^2} \right] f_{n\kappa}(z), \tag{21}$$

whose solutions are the hypergeometric functions (Gradshteyn & Ryzhik, 2007), its general form can be expressed as

$$f_{n\kappa}(z) = A {}_2F_1(a, b; c; z) + Bz^{1-c} {}_2F_1(a - c + 1, b - c + 1; 2 - c; z), \tag{22}$$

in which the first term can be expressed as:

$${}_2F_1(a, b; c; z) = \frac{\Gamma(c)}{\Gamma(a)\Gamma(b)} \sum_{k=0}^{\infty} \frac{\Gamma(a+k)\Gamma(b+k)z^k}{\Gamma(c+k)k!}, \tag{23}$$

where

$$\begin{aligned} a &= 1 + q + \beta - \gamma \\ b &= 1 + q + \beta + \gamma \\ c &= 1 + 2\beta \\ \gamma &= \sqrt{\beta^2 - \frac{(\tilde{V}_2 + 2\tilde{V}_1)}{2\alpha^2} + q(1 + q) - \frac{\kappa(\kappa + 1)C_1}{4\alpha^2r_0^2}}. \end{aligned} \tag{24}$$

The hypergeometric function $f_{n\kappa}(z)$ can be reduced to polynomial of degree n , whenever either a or b equals to a negative integer $-n$. This implies that the hypergeometric function $f_{n\kappa}(z)$ given by equation (23) can only be finite everywhere unless

$$a = 1 + q + \beta - \gamma = -n; \quad n = 0, 1, 2, 3, \dots \tag{25}$$

Using equations (17), (19) and (20) in equation (25), an explicit expression for the energy eigenvalues of the Dirac equation with the Rosen-Morse potential under the spin symmetry condition is obtained as:

$$\begin{aligned} (Mc^2 + E_{n\kappa} - C_s)(Mc^2 - E_{n\kappa} + V_2) &= -\frac{\kappa(\kappa + 1)C_0}{r_0^2}\hbar^2c^2 \\ + 4\alpha^2\hbar^2c^2 \left[\frac{\frac{(C_2 - C_1)}{4\alpha^2r_0^2}\kappa(\kappa + 1) - \frac{(Mc^2 + E_{n\kappa} - C_s)V_2}{2\alpha^2\hbar^2c^2}}{2(n + q + 1)} - \frac{(n + q + 1)}{2} \right]^2. \end{aligned} \tag{26}$$

It is observed that, the spin symmetric limit leads to quadratic energy eigenvalues. Hence, the solution of equation (26) consists of positive and negative energy eigenvalues for each n and κ . In 2005, Ginocchio has shown that there are only positive energy eigenvalues and no bound

negative energy eigenvalues exist in the spin limit. Therefore, in the spin limit, only positive energy eigenvalues are chosen for the spin symmetric limit.

Using equations (18) to (25), the radial upper component spinor can be obtained as

$$\begin{aligned}
 F_{nk}(r) &= N_{nk}(1 + e^{-2\alpha r})^{1+q}(-e^{-2\alpha r})^\beta {}_2F_1(-n, n + 2(\beta + q + 1); 2\beta + 1; -e^{-2\alpha r}) \\
 &= N_{nk} \frac{n!\Gamma(2\beta + 1)}{\Gamma(n + \beta + 1)} (1 + e^{-2\alpha r})^{1+q}(-e^{-2\alpha r})^\beta P_n^{(2\beta, 2q+1)}(1 + 2e^{-2\alpha r}), \tag{27}
 \end{aligned}$$

N_{nk} is the normalization constant which can be determined by the condition that $\int_0^\infty |F_{nk}(r)|^2 dr = 1$.

By making use of the equation (23) and the following integral (see formula (7.512.12) in Gradshteyn & Ryzhik (2007)):

$$\int_0^1 (1-x)^{\mu-1} x^{\nu-1} {}_pF_q(a_1, \dots, a_p; b_1, \dots, b_q; ax) dx = \frac{\Gamma(\mu)\Gamma(\nu)}{\Gamma(\mu+\nu)} {}_{p+1}F_{q+1}(\nu, a_1, \dots, a_p; \mu+\nu, b_1, \dots, b_q; a), \tag{28}$$

which is valid for $Re\mu > 0, Re\nu > 0, p \leq q + 1$, if $p = q + 1$, then $|q < 1|$, this leads to

$$N_{nk} = \left[\frac{\Gamma(2q + 3)\Gamma(2\beta + 1)}{2\alpha\Gamma(n)} \sum_{k=0}^\infty \frac{(-1)^k (n + 2(1 + \beta + q))_k \Gamma(n + k)}{k!(k + 2\beta)!\Gamma(k + 2(\beta + q + \frac{3}{2}))} A_{nk} \right]^{-1/2}, \tag{29}$$

where $A_{nk} = {}_3F_2(2\beta + k, -n, n + 2(1 + \beta + q); k + 2(\beta + q + \frac{3}{2}); 2\beta + 1; 1)$ and $(x)_a = \frac{\Gamma(x+a)}{\Gamma(x)}$ (Pochhammer symbol). In order to find the lower component spinor, the recurrence relation of the hypergeometric function (Gradshteyn & Ryzhik, 2007)

$$\frac{d}{d\xi} [{}_2F_1(a, b, c; \xi)] = \left(\frac{ab}{c}\right) \frac{d}{d\xi} {}_2F_1(a + 1, b + 1, c + 1; \xi), \tag{30}$$

is used to evaluate equation (10) and this is obtained as

$$\begin{aligned}
 G_{nk}(r) &= \frac{N_{nk}(1 + e^{-2\alpha r})^{1+q}(-e^{-2\alpha r})^\beta}{[Mc^2 + E_{nk} - C_s]} \left[-2\alpha\beta - \frac{2\alpha e^{-2\alpha r}}{1 + e^{-2\alpha r}} + \frac{\kappa}{r} \right] \\
 &\quad \times {}_2F_1(-n, n + 2(\beta + q + 1); 2\beta + 1; -e^{-2\alpha r}) + \\
 &\quad \frac{N_{nk}(1 + e^{-2\alpha r})^{1+q}(-e^{-2\alpha r})^{\beta+1}}{[Mc^2 + E_{nk} - C_s]} \left\{ \frac{2\alpha n [n + 2(\beta + q + 1)]}{(2\beta + 1)} \right\} \\
 &\quad \times {}_2F_1(-n + 1, n + 2(\beta + q + \frac{3}{2}); 2(\beta + 1); -e^{-2\alpha r}). \tag{31}
 \end{aligned}$$

3.2 Pseudospin symmetry solutions of the Dirac equation with the Rosen-Morse potential with arbitrary κ

In the case of pseudospin symmetry, that is, the difference as in equation (11). $\frac{d\Sigma(r)}{dr} = 0$ or $\Sigma(r) = \text{Constant} = C_{ps}$, and taking into consideration the choice of $\Delta(r) = 2V(r) \rightarrow V(r)$ as earlier illustrated by Alhaidari et al. (2006). Then,

$$\Delta(r) = -4V_1 \frac{e^{-2\alpha r}}{(1 + e^{-2\alpha r})^2} + V_2 \frac{(1 - e^{-2\alpha r})}{(1 + e^{-2\alpha r})}. \tag{32}$$

With the pseudo-centrifugal approximation in equation (13) and substituting $z = -e^{-2\alpha r}$, then, the following equation for the lower component spinor $G_{n\kappa}(r)$ is obtained as:

$$z^2 \frac{d^2}{dz^2} G_{n\kappa}(z) + z \frac{d}{dz} G_{n\kappa}(z) + \frac{1}{4\alpha^2} \left\{ \frac{1}{\hbar^2 c^2} [E_{n\kappa}^2 - M^2 c^4 - C_{ps}(Mc^2 + E_{n\kappa})] \right\} G_{n\kappa}(z) - \frac{\kappa(\kappa - 1)}{4\alpha^2} \left\{ \frac{1}{r_0^2} \left[C_0 + C_1 \frac{z}{1-z} + C_2 \frac{z^2}{(1-z)^2} \right] - \frac{4\tilde{V}_3 z}{(1-z)^2} - \tilde{V}_4 - \frac{2\tilde{V}_4 z}{(1-z)} \right\} G_{n\kappa}(z), \tag{33}$$

where

$$\tilde{V}_3 = \frac{V_1}{\hbar^2 c^2} [Mc^2 - E_{n\kappa} + C_{ps}] \text{ and } \tilde{V}_4 = \frac{V_2}{\hbar^2 c^2} [Mc^2 - E_{n\kappa} + C_{ps}]. \tag{34}$$

With boundary conditions in the previous subsection, then, writing the function $G_{n\kappa}(z)$ as

$$G_{n\kappa}(z) = (1 - z)^{1+\bar{q}} z^{\bar{\beta}} g_{n\kappa}(z), \tag{35}$$

where

$$\bar{q} = \frac{1}{2} \left[-1 + \sqrt{1 + \frac{\kappa(\kappa - 1)C_2}{\alpha^2 r_0^2} - \frac{4\tilde{V}_3}{\alpha^2}} \right] \tag{36}$$

and

$$-\bar{\beta}^2 = \frac{1}{4\alpha^2} \left\{ \frac{1}{\hbar^2 c^2} [E_{n\kappa}^2 - M^2 c^4 - C_{ps}(Mc^2 + E_{n\kappa})] - \frac{\kappa(\kappa - 1)}{r_0^2} C_0 + \tilde{V}_4 \right\}. \tag{37}$$

On substituting equation (35) into equation (33) and using equations (34), (36) and (37), equation (33) becomes

$$z(1 - z) \frac{d^2}{dz^2} g_{n\kappa}(z) + [(2\bar{\beta} + 1) - (2\bar{q} + 2\bar{\beta} + 3)z] \frac{d}{dz} g_{n\kappa}(z) - \left[(2\bar{\beta} + 1)(1 + \bar{q}) - \frac{\tilde{V}_4 + 2\tilde{V}_3}{2\alpha^2} + \frac{\kappa(\kappa - 1)C_1}{4\alpha^2 r_0^2} \right] g_{n\kappa}(z), \tag{38}$$

whose solutions are the hypergeometric functions (Gradshteyn & Ryzhik, 2007), its general form can be expressed as

$$f_{n\kappa}(z) = A {}_2F_1(a, b; c; z) + Bz^{1-c} {}_2F_1(a - c + 1, b - c + 1; 2 - c; z), \tag{39}$$

in which the first term can be expressed as:

$${}_2F_1(a, b; c; z) = \frac{\Gamma(c)}{\Gamma(a)\Gamma(b)} \sum_{k=0}^{\infty} \frac{\Gamma(a+k)\Gamma(b+k)z^k}{\Gamma(c+k)k!}, \tag{40}$$

where

$$a = 1 + \bar{q} + \bar{\beta} - \bar{\gamma}$$

$$b = 1 + \bar{q} + \bar{\beta} + \bar{\gamma}$$

$$c = 1 + 2\bar{\beta}$$

$$\bar{\gamma} = \sqrt{\bar{\beta}^2 + \frac{(\tilde{V}_2 + 2\tilde{V}_3)}{2\alpha^2} + \bar{q}(1 + \bar{q}) - \frac{\kappa(\kappa - 1)C_1}{4\alpha^2 r_0^2}}. \tag{41}$$

Also, in the similar fashion as obtained in the case of the spin symmetry condition, an explicit expression for the energy eigenvalues of the Dirac equation with the Rosen-Morse potential under the pseudospin symmetry is obtained as:

$$\begin{aligned} (Mc^2 - E_{n\kappa} + C_{ps})(Mc^2 + E_{n\kappa} - V_2) &= -\frac{\kappa(\kappa - 1)C_0}{r_0^2} \hbar^2 c^2 \\ + 4\alpha^2 \hbar^2 c^2 &\left[\frac{\frac{(C_2 - C_1)}{4\alpha^2 r_0^2} \kappa(\kappa - 1) + \frac{(Mc^2 - E_{n\kappa} + C_{ps})V_2}{2\alpha^2 \hbar^2 c^2}}{2(n + \bar{q} + 1)} - \frac{(n + \bar{q} + 1)}{2} \right]^2. \end{aligned} \tag{42}$$

It is observed that, the pseudospin symmetric limit leads to quadratic energy eigenvalues. Therefore, the solution of equation (42) consists of positive and negative energy eigenvalues for each n and κ . Since, it has been shown that there are only negative energy eigenvalues and no bound positive energy eigenvalues exist in the pseudospin limit (Ginocchio, 2005). Therefore, in the pseudospin limit, only negative energy eigenvalues are chosen. The radial lower component spinor can be obtained by considering equations (35)-(41) as

$$\begin{aligned} G_{n\kappa}(r) &= \bar{N}_{n\kappa} (1 + e^{-2\alpha r})^{1+\bar{q}} (-e^{-2\alpha r})^{\bar{\beta}} {}_2F_1(-n, n + 2(\bar{\beta} + \bar{q} + 1); 2\bar{\beta} + 1; -e^{-2\alpha r}) \\ &= \bar{N}_{n\kappa} \frac{n! \Gamma(2\bar{\beta} + 1)}{\Gamma(n + \bar{\beta} + 1)} (1 + e^{-2\alpha r})^{1+\bar{q}} (-e^{-2\alpha r})^{\bar{\beta}} P_n^{(2\bar{\beta}, 2\bar{q}+1)}(1 + 2e^{-2\alpha r}) \end{aligned} \tag{43}$$

$\bar{N}_{n\kappa}$ is the normalization constant which can be determined by the condition that $\int_0^\infty |G_{n\kappa}(r)|^2 dr = 1$ and by making use of the equations (23) and (28), we have

$$\bar{N}_{n\kappa} = \left[\frac{\Gamma(2\bar{q} + 3)\Gamma(2\bar{\beta} + 1)}{2\alpha\Gamma(n)} \sum_{k=0}^\infty \frac{(-1)^k (n + 2(1 + \bar{\beta} + \bar{q}))_k \Gamma(n + k)}{k!(k + 2\bar{\beta})! \Gamma(k + 2(\bar{\beta} + \bar{q} + \frac{3}{2}))} \bar{A}_{n\kappa} \right]^{-1/2}, \tag{44}$$

where $\bar{A}_{n\kappa} = {}_3F_2(2\bar{\beta} + k, -n, n + 2(1 + \bar{\beta} + \bar{q}); k + 2(\bar{\beta} + \bar{q} + \frac{3}{2}); 2\bar{\beta} + 1; 1)$ and $(x)_a = \frac{\Gamma(x+a)}{\Gamma(x)}$ (Pochhammer symbol).

Similarly, by using equation (12) $F_{n\kappa}(r)$ can also be obtained as

$$\begin{aligned}
 F_{n\kappa}(r) = & \frac{\bar{N}_{n\kappa}(1 + e^{-2\alpha r})^{1+\bar{q}}(-e^{-2\alpha r})^{\bar{\beta}}}{[Mc^2 - E_{n\kappa} + C_{ps}]} \left[-2\alpha\bar{\beta} - \frac{2\alpha e^{-2\alpha r}}{1 + e^{-2\alpha r}} - \frac{\kappa}{r} \right] \\
 & \times {}_2F_1(-n, n + 2(\bar{\beta} + \bar{q} + 1); 2\bar{\beta} + 1; -e^{-2\alpha r}) + \\
 & \frac{\bar{N}_{n\kappa}(1 + e^{-2\alpha r})^{1+\bar{q}}(-e^{-2\alpha r})^{\bar{\beta}+1}}{[Mc^2 - E_{n\kappa} + C_{ps}]} \left\{ \frac{2\alpha n [n + 2(\bar{\beta} + \bar{q} + 1)]}{(2\bar{\beta} + 1)} \right\} \\
 & \times {}_2F_1(-n + 1, n + 2(\bar{\beta} + \bar{q} + \frac{3}{2}); 2(\bar{\beta} + 1); -e^{-2\alpha r}). \tag{45}
 \end{aligned}$$

It is pertinent to note that, the negative energy solution for the pseudospin symmetry can be obtained directly from the positive energy solution of the spin symmetry using the parameter mapping (Berkdemir & Cheng, 2009; Ikhdair, 2010):

$$F_{n\kappa}(r) \leftrightarrow G_{n\kappa}(r), V(r) \rightarrow -V(r), \text{ (or } V_1 \rightarrow -V_1 \text{ and } V_2 \rightarrow -V_2), E_{n\kappa} \rightarrow -E_{n\kappa} \text{ and } C_s \rightarrow -C_{ps}.$$

3.3 Remarks

In this work, solutions of some special cases are studied:

3.3.1 s-wave solutions:

Our results include any arbitrary κ values, therefore, there is need to investigate if our results will give similar results for s-wave for the spin symmetry when $\kappa = -1$ or $\ell = 0$ and for the pseudospin when $\kappa = 1$ or $\bar{\ell} = 0$.

For the SS, $\kappa = -1$ (or $\ell = 0$) in equation (26) gives

$$(Mc^2 + E_{n,-1} - C_s)(Mc^2 - E_{n,-1} + V_2) = 4\alpha^2\hbar^2c^2 \left[\frac{(Mc^2 + E_{n,-1} - C_s)V_2}{2\alpha^2\hbar^2c^2} - \frac{(n + q_1 + 1)}{2} \right]^2, \tag{46}$$

where

$$q_1 = \frac{1}{2} \left[-1 + \sqrt{1 + \frac{4V_1[Mc^2 + E_{n,-1} - C_s]}{\alpha^2\hbar^2c^2}} \right]. \tag{47}$$

For the PSS, $\kappa = 1$ (or $\bar{\ell} = 0$) in equation (42) gives

$$(Mc^2 - E_{n,1} + C_{ps})(Mc^2 + E_{n,1} - V_2) = 4\alpha^2\hbar^2c^2 \left[\frac{(Mc^2 - E_{n,1} + C_{ps})V_2}{2\alpha^2\hbar^2c^2} - \frac{(n + \bar{q}_1 + 1)}{2} \right]^2, \tag{48}$$

where

$$\bar{q}_1 = \frac{1}{2} \left[-1 + \sqrt{1 - \frac{4V_1[Mc^2 - E_{n,1} + C_{ps}]}{\alpha^2\hbar^2c^2}} \right]. \tag{49}$$

The corresponding upper and lower component spinors for the SS and PSS can be obtained also. The above solutions are identical with the results obtained by Oyewumi & Akoshile (2010) and Ikhdair (2010).

3.3.2 Solutions for the standard Eckart potential:

By setting $V_1 = -V_1$ and $V_2 = -V_2$ in equation (1), we have the standard Eckart potential. The energy eigenvalues for the SS and the PSS are given, respectively as:

$$(Mc^2 + E_{n\kappa} - C_s)(Mc^2 - E_{n\kappa} - V_2) = -\frac{\kappa(\kappa + 1)C_0}{r_0^2}\hbar^2c^2 + 4\alpha^2\hbar^2c^2 \left[\frac{\frac{(C_2 - C_1)}{4\alpha^2r_0^2}\kappa(\kappa + 1) + \frac{(Mc^2 + E_{n\kappa} - C_s)V_2}{2\alpha^2\hbar^2c^2}}{2(n + q_2 + 1)} - \frac{(n + q_2 + 1)}{2} \right]^2 \quad (50)$$

and

$$(Mc^2 - E_{n\kappa} + C_{ps})(Mc^2 + E_{n\kappa} + V_2) = -\frac{\kappa(\kappa - 1)C_0}{r_0^2}\hbar^2c^2 + 4\alpha^2\hbar^2c^2 \left[\frac{\frac{(C_2 - C_1)}{4\alpha^2r_0^2}\kappa(\kappa - 1) - \frac{(Mc^2 - E_{n\kappa} + C_{ps})V_2}{2\alpha^2\hbar^2c^2}}{2(n + \bar{q}_2 + 1)} - \frac{(n + \bar{q}_2 + 1)}{2} \right]^2, \quad (51)$$

where q_2 and \bar{q}_2 are obtained, respectively as:

$$q_2 = \frac{1}{2} \left[-1 + \sqrt{1 + \frac{\kappa(\kappa + 1)C_2}{\alpha^2r_0^2} - \frac{4V_1[Mc^2 + E_{n\kappa} - C_s]}{\alpha^2\hbar^2c^2}} \right] \\ \bar{q}_2 = \frac{1}{2} \left[-1 + \sqrt{1 + \frac{\kappa(\kappa - 1)C_2}{\alpha^2r_0^2} + \frac{4V_1[Mc^2 - E_{n\kappa} + C_{ps}]}{\alpha^2\hbar^2c^2}} \right]. \quad (52)$$

The corresponding upper and lower component spinors for the SS and the PSS can easily be obtained from equations (27), (31), (43) and (45).

3.3.3 Solutions of the PT-Symmetric Rosen-Morse potential:

The choice of $V_2 = iV_2$ in equation (1) gives the PT-Symmetric Rosen-Morse potential (Jia et al., 2002; Yi et al., 2004; Taşkin, 2009; Oyewumi & Akoshile, 2010; Ikhdair, 2010):

$$V(r) = -V_1 \operatorname{sech}^2 ar + iV_2 \tanh ar. \quad (53)$$

For a given potential $V(r)$, if $V(-r) = V^*(r)$ (or $V(\eta - r) = V^*(r)$) exists, then, the potential $V(r)$ is said to be PT-Symmetric. Here, P denotes the parity operator (space reflection, $P : r \rightarrow -r$, or $r \rightarrow \eta - r$) and T denotes the time reversal operator ($T : i \rightarrow -i$).

For the case of the SS and the PSS solutions of this PT-Symmetric version of the Rosen-Morse potential, the energy eigenvalue equations are:

$$(Mc^2 + E_{n\kappa} - C_s)(Mc^2 - E_{n\kappa} + iV_2) = -\frac{\kappa(\kappa + 1)C_0}{r_0^2}\hbar^2c^2 + 4\alpha^2\hbar^2c^2 \left[\frac{\frac{(C_2 - C_1)}{4\alpha^2r_0^2}\kappa(\kappa + 1) - i\frac{(Mc^2 + E_{n\kappa} - C_s)V_2}{2\alpha^2\hbar^2c^2}}{2(n + q + 1)} - \frac{(n + q + 1)}{2} \right]^2 \quad (54)$$

and

$$(Mc^2 - E_{n\kappa} + C_{ps})(Mc^2 + E_{n\kappa} - iV_2) = -\frac{\kappa(\kappa - 1)C_0}{r_0^2}\hbar^2 c^2 + 4\alpha^2\hbar^2 c^2 \left[\frac{\frac{(C_2 - C_1)}{4\alpha^2 r_0^2} \kappa(\kappa - 1) + i \frac{(Mc^2 - E_{n\kappa} + C_{ps})V_2}{2\alpha^2 \hbar^2 c^2}}{2(n + \bar{q} + 1)} - \frac{(n + \bar{q} + 1)}{2} \right]^2, \quad (55)$$

respectively. q and \bar{q} have their usual values as in equations (19) and (36), the corresponding upper and lower component spinors for the SS and the PSS can be obtained directly from equations (27), (31), (43) and (45).

3.3.4 Solutions of the reflectionless-type potential:

If we choose $V_2 = 0$ and $V_1 = \frac{1}{2}\xi(\xi + 1)$ in equation (1), then equation (1) becomes the reflectionless-type potential (Grosche & Steiner, 1995; 1998; Zhao et al., 2005):

$$V(r) = -\xi(\xi + 1)\text{sech}^2 \alpha r, \quad (56)$$

where ξ is an integer, that is, $\xi = 1, 2, 3, \dots$.

For the SS solutions of the reflectionless-type potential, the energy eigenvalues, the upper and the lower component spinors are obtained, respectively as:

$$(Mc^2 + E_{n\kappa} - C_s)(Mc^2 - E_{n\kappa}) = -\frac{\kappa(\kappa + 1)C_0}{r_0^2}\hbar^2 c^2 + \alpha^2\hbar^2 c^2 \left[\frac{\frac{(C_2 - C_1)}{4\alpha^2 r_0^2} \kappa(\kappa + 1)}{2(n + q_3 + 1)} - \frac{(n + q_3 + 1)}{2} \right]^2, \quad (57)$$

$$\begin{aligned} F_{n\kappa}(r) &= N_{n\kappa}(1 + e^{-2\alpha r})^{1+q_3} (-e^{-2\alpha r})^{\beta_3} {}_2F_1(-n, n + 2(\beta_3 + q_3 + 1); 2\beta_3 + 1; -e^{-2\alpha r}) \\ &= N_{n\kappa} \frac{n! \Gamma(2\beta_3 + 1)}{\Gamma(n + \beta_3 + 1)} (1 + e^{-2\alpha r})^{1+q_3} (-e^{-2\alpha r})^{\beta_3} P_n^{(2\beta_3, 2q_3 + 1)}(1 + 2e^{-2\alpha r}) \end{aligned} \quad (58)$$

and

$$\begin{aligned} G_{n\kappa}(r) &= \frac{N_{n\kappa}(1 + e^{-2\alpha r})^{1+q_3} (-e^{-2\alpha r})^{\beta_3}}{[Mc^2 + E_{n\kappa} - C_s]} \left[-2\alpha\beta_3 - \frac{2\alpha e^{-2\alpha r}}{1 + e^{-2\alpha r}} + \frac{\kappa}{r} \right] \\ &\quad \times {}_2F_1(-n, n + 2(\beta_3 + q_3 + 1); 2\beta_3 + 1; -e^{-2\alpha r}) + \\ &\quad \frac{N_{n\kappa}(1 + e^{-2\alpha r})^{1+q_3} (-e^{-2\alpha r})^{\beta_3 + 1}}{[Mc^2 + E_{n\kappa} - C_s]} \left\{ \frac{2\alpha n [n + 2(\beta_3 + q_3 + 1)]}{(2\beta_3 + 1)} \right\} \\ &\quad \times {}_2F_1(-n + 1, n + 2(\beta_3 + q_3 + \frac{3}{2}); 2(\beta_3 + 1); -e^{-2\alpha r}), \end{aligned} \quad (59)$$

where

$$q_3 = \frac{1}{2} \left[-1 + \sqrt{1 + \frac{\kappa(\kappa + 1)C_2}{\alpha^2 r_0^2} + \frac{2\xi(\xi + 1)[Mc^2 + E_{n\kappa} - C_s]}{\alpha^2 \hbar^2 c^2}} \right] \quad (60)$$

and

$$\beta_3 = \sqrt{\frac{\kappa(\kappa + 1)}{4\alpha^2 r_0^2} C_0 - \frac{1}{4\alpha^2 \hbar^2 c^2} [E_{n\kappa}^2 - M^2 c^4 + C_s (Mc^2 - E_{n\kappa})]}. \tag{61}$$

For the PSS solutions of the reflectionless-type potential, the energy eigenvalues, the upper and the lower component spinors are obtained, respectively as:

$$(Mc^2 - E_{n\kappa} + C_{ps})(Mc^2 + E_{n\kappa}) = -\frac{\kappa(\kappa - 1)C_0}{r_0^2} \hbar^2 c^2 + \alpha^2 \hbar^2 c^2 \left[\frac{\frac{(C_2 - C_1)}{\alpha^2 r_0^2} \kappa(\kappa - 1)}{2(n + \bar{q}_3 + 1)} - \frac{(n + \bar{q}_3 + 1)}{2} \right]^2, \tag{62}$$

$$\begin{aligned} G_{n\kappa}(r) &= \bar{N}_{n\kappa} (1 + e^{-2\alpha r})^{1 + \bar{q}_3} (-e^{-2\alpha r})^{\bar{\beta}_3} {}_2F_1(-n, n + 2(\bar{\beta}_3 + \bar{q}_3 + 1); 2\bar{\beta}_3 + 1; -e^{-2\alpha r}) \\ &= \bar{N}_{n\kappa} \frac{n! \Gamma(2\bar{\beta}_3 + 1)}{\Gamma(n + \bar{\beta}_3 + 1)} (1 + e^{-2\alpha r})^{1 + \bar{q}_3} (-e^{-2\alpha r})^{\bar{\beta}_3} P_n^{(2\bar{\beta}_3, 2\bar{q}_3 + 1)}(1 + 2e^{-2\alpha r}) \end{aligned} \tag{63}$$

and

$$\begin{aligned} F_{n\kappa}(r) &= \frac{\bar{N}_{n\kappa} (1 + e^{-2\alpha r})^{1 + \bar{q}_3} (-e^{-2\alpha r})^{\bar{\beta}_3}}{[Mc^2 - E_{n\kappa} + C_{ps}]} \left[-2\alpha \bar{\beta}_3 - \frac{2\alpha e^{-2\alpha r}}{1 + e^{-2\alpha r}} - \frac{\kappa}{r} \right] \\ &\quad \times {}_2F_1(-n, n + 2(\bar{\beta}_3 + \bar{q}_3 + 1); 2\bar{\beta}_3 + 1; -e^{-2\alpha r}) + \\ &\quad \frac{\bar{N}_{n\kappa} (1 + e^{-2\alpha r})^{1 + \bar{q}_3} (-e^{-2\alpha r})^{\bar{\beta}_3 + 1}}{[Mc^2 - E_{n\kappa} + C_{ps}]} \left\{ \frac{2\alpha n [n + 2(\bar{\beta}_3 + \bar{q}_3 + 1)]}{(2\bar{\beta}_3 + 1)} \right\} \\ &\quad \times {}_2F_1(-n + 1, n + 2(\bar{\beta}_3 + \bar{q}_3 + \frac{3}{2}); 2(\bar{\beta}_3 + 1); -e^{-2\alpha r}), \end{aligned} \tag{64}$$

where

$$\bar{q}_3 = \frac{1}{2} \left[-1 + \sqrt{1 + \frac{\kappa(\kappa - 1)C_2}{\alpha^2 r_0^2} - \frac{2\xi(\xi + 1)[Mc^2 - E_{n\kappa} + C_{ps}]}{\alpha^2 \hbar^2 c^2}} \right] \tag{65}$$

and

$$\bar{\beta}_3 = \sqrt{\frac{\kappa(\kappa - 1)}{4\alpha^2 r_0^2} C_0 - \frac{1}{4\alpha^2 \hbar^2 c^2} [E_{n\kappa}^2 - M^2 c^4 - C_{ps} (Mc^2 + E_{n\kappa})]}. \tag{66}$$

3.3.5 Solutions of the non-relativistic limit

The approximate solutions of the Schrödinger equation for the Rosen-Morse potential including the centrifugal term can be obtained from our work. This can be done by equating $C_s = 0, S(r) = V(r) = \Sigma(r)$ in equations (26) and (27). By using the following appropriate transformations suggested by Ikhdair (2010):

$$\begin{aligned} \frac{(Mc^2 + E_{n\kappa})}{\hbar^2 c^2} &\rightarrow \frac{2\mu}{\hbar^2} \\ Mc^2 - E_{n\kappa} &\rightarrow -E_{n\ell} \\ \kappa &\rightarrow \ell, \end{aligned} \tag{67}$$

the non-relativistic limit of the energy equation and the associated wave functions, respectively become:

$$E_{n\ell} = V_2 + \frac{\ell(\ell + 1)\hbar^2 C_0}{2\mu r_0^2} - \frac{\hbar^2 c^2}{2\mu} \left[\frac{(n + 1)^2 + (2n + 1)q_0 + \frac{\ell(\ell + 1)C_1}{4\alpha^2 r_0^2} + \frac{\mu}{\alpha^2 \hbar^2} (2V_1 + V_2)}{(n + q_0 + 1)} \right]^2, \tag{68}$$

and

$$\begin{aligned} F_{n\ell}(r) &= N_{n\ell} (1 + e^{-2\alpha r})^{1+q_0} (-e^{-2\alpha r})^{\beta_0} {}_2F_1(-n, n + 2(\beta_0 + q_0 + 1); 2\beta_0 + 1; -e^{-2\alpha r}) \\ &= N_{n\ell} \frac{n! \Gamma(2\beta_0 + 1)}{\Gamma(n + \beta_0 + 1)} (1 + e^{-2\alpha r})^{1+q_0} (-e^{-2\alpha r})^{\beta_0} P_n^{(2\beta_0, 2q_0 + 1)}(1 - 2z), \end{aligned} \tag{69}$$

where

$$q_0 = \frac{1}{2} \left[-1 + \sqrt{1 + \frac{\ell(\ell + 1)C_2}{\alpha^2 r_0^2} + \frac{8\mu V_1}{\alpha^2 \hbar^2}} \right] \tag{70}$$

and

$$\beta_0 = \sqrt{\frac{\ell(\ell + 1)}{4\alpha^2 r_0^2} C_0 + \frac{\mu V_2}{2\alpha^2 \hbar^2} - \frac{\mu E_{n\ell}}{2\alpha^2 \hbar^2}}. \tag{71}$$

By using the appropriate transformations suggested by Ikhdaïr (2010), the non-relativistic limit of energy equation and the associated wave functions of the Schrödinger equation for the Rosen-Morse potential are recovered completely. These results are identical with the results of Ikhdaïr (2010), Taşkin (2009)(note that Taşkin (2009) used $\hbar = \mu = 1$ in his calculations).

4. The relativistic bound state solutions of the Rosen-Morse potential with the centrifugal term

The Klein-Gordon and the Dirac equations describe relativistic particles with zero or integer and 1/2 integral spins, respectively (Landau & Lifshitz 1999; Merzbacher, 1998; Greiner, 2000; Alhaidari et al., 2006; Dong, 2007). However, the exact solutions are only possible for a few simple systems such as the hydrogen atom, the harmonic oscillator, Kratzer potential and pseudoharmonic potential.

In the following specific examples, Soylu et al. (2008c) obtained the *s*-wave solutions of the Klein-Gordon equation with equal scalar and vector Rosen-Morse potential by using the asymptotic iteration method. Also, Yi et al. (2004) obtained the energy equation and the corresponding wave functions of the Klein-Gordon equation for the Rosen-Morse-type potential by using standard and functional method.

For the approximate solutions of the Schrödinger equation for the Rosen-Morse potential with the centrifugal term, that is $\ell \neq 0$ or $\kappa = 1$, with the standard function analysis method, Taşkin (2009) has used the newly improved Pekeris-type approximation introduced by Lu (2005). In addition, Ikot and Akpabio (2010) solved this same problem by using the Nikiforov-Uvarov method, they used the approximation scheme introduced by Jia et al. (2009a, 2009b) and Xu et al. (2010).

In the recent years, some researchers have used the Pekeris-type approximation scheme for the centrifugal term to solve the relativistic equations to obtain the ℓ or κ - wave energy equations and the associated wave functions of some potentials. These include: Morse potential (Bayrak et al., 2010), hyperbolical potential (Wei & Liu, 2008), Manning-Rosen potential (Wei & Dong, 2010), Deng-Fan oscillator (Dong, 2011).

In the context of the standard function analysis approach, the approximate bound state solutions of the arbitrary ℓ -state Klein-Gordon and κ -state Dirac equations for the equally mixed Rosen-Morse potential will be obtained by introducing a newly improved approximation scheme to the centrifugal term.

4.1 Approximate bound state solutions of the Klein-Gordon equation for the Rosen-Morse potential for $\ell \neq 0$

The time-independent Klein-Gordon equation with the scalar $S(r)$ and vector $V(r)$ potentials is given as (Landau & Lifshift, 1999; Merzbacher, 1998; Greiner, 2000; Alhaidari et al., 2006):

$$\left\{ -\hbar^2 c^2 \nabla^2 + [Mc^2 + S(r)]^2 - [E - V(r)]^2 \right\} \psi(r, \theta, \phi) = 0, \quad (72)$$

where M , \hbar and c are the rest mass of the spin-0 particle, Planck's constant and velocity of the light, respectively. For spherical symmetrical scalar and vector potentials, putting

$$\psi_{n,\ell,m}(r, \theta, \phi) = \frac{1}{r} U_{n,\ell}(r) Y_{\ell,m}(\theta, \phi), \quad (73)$$

where $Y_{\ell,m}(\theta, \phi)$ is the spherical harmonic function, we obtain the radial Klein-Gordon equation as

$$U''_{n,\ell}(r) + \frac{1}{\hbar^2 c^2} \left\{ E^2 - M^2 c^4 - 2 [EV(r) + Mc^2 S(r)] + [V^2(r) - S^2(r)] - \frac{\ell(\ell+1)\hbar^2 c^2}{r^2} \right\} U_{n,\ell}(r) = 0. \quad (74)$$

We are considering the case when the scalar and vector potentials are equal (that is, $S(r) = V(r)$), coupled with the resulting simplification in the solution of the relativistic problems as discussed by Alhaidari et al., 2006, we have

$$U''_{n,\ell}(r) + \frac{1}{\hbar^2 c^2} \left\{ E^2 - M^2 c^4 - [E + Mc^2] V(r) - \frac{\ell(\ell+1)\hbar^2 c^2}{r^2} \right\} U_{n,\ell}(r) = 0. \quad (75)$$

This equation cannot be solved analytically for the Rosen-Morse potential with $\ell \neq 0$, unless, we introduce the approximation scheme (earlier discussed in this chapter) to the centrifugal term. With this approximation scheme, and the potential in (1) together with the transformation $z = -e^{-2\alpha r}$ in equation (75), we have

$$z^2 U''_{n,\ell}(z) + z U'_{n,\ell}(z) + \left[\frac{E^2 - M^2 c^4}{4\alpha^2 \hbar^2 c^2} - \frac{\tilde{V}_5}{\alpha^2} \frac{z}{(1-z)^2} - \frac{\tilde{V}_6}{4\alpha^2} \frac{(1+z)}{(1-z)} - \frac{\ell(\ell+1)C_0}{4\alpha^2 r_0^2} - \frac{\ell(\ell+1)C_1}{4\alpha^2 r_0^2} \frac{z}{(1-z)} - \frac{\ell(\ell+1)C_2}{4\alpha^2 r_0^2} \frac{z^2}{(1-z)^2} \right] U_{n,\ell}(z) = 0, \quad (76)$$

where

$$\begin{aligned} \tilde{V}_5 &= \frac{V_1}{\hbar^2 c^2} [E + Mc^2] \\ \tilde{V}_6 &= \frac{V_2}{\hbar^2 c^2} [E + Mc^2]. \end{aligned} \tag{77}$$

In the similar manner, the energy equation of the arbitrary ℓ -state Klein-Gordon equation with equal scalar and vector potentials of the Rosen-Morse potential is obtained as follows:

$$\begin{aligned} (E_{n,\ell}^2 - M^2 c^4) &= (E_{n,\ell} + Mc^2) V_2 + \frac{\ell(\ell + 1) C_0}{r_0^2} \hbar^2 c^2 \\ -4\alpha^2 \hbar^2 c^2 &\left[\frac{\frac{(C_2 - C_1)}{4\alpha^2 r_0^2} \ell(\ell + 1) - \frac{(E_{n,\ell} + Mc^2) V_2}{2\alpha^2 \hbar^2 c^2}}{2(n + \delta_1 + 1)} - \frac{(n + \delta_1 + 1)}{2} \right]^2, \end{aligned} \tag{78}$$

where

$$\delta_1 = \frac{1}{2} \left[-1 + \sqrt{1 + \frac{\ell(\ell + 1) C_2}{\alpha^2 r_0^2} + \frac{4(E_{n,\ell} + Mc^2)}{\alpha^2 \hbar^2 c^2}} \right]. \tag{79}$$

The associated wave function can be expressed as

$$\begin{aligned} U_{n,\ell}(r) &= N_{n,\ell} (1 + e^{-2ar})^{1+\delta_1} (-e^{-2ar})^{\xi_1} {}_2F_1(-n, n + 2(\xi_1 + \delta_1 + 1); 2\xi_1 + 1; -e^{-2ar}) \\ &= N_{n,\ell} \frac{n! \Gamma(2\xi_1 + 1)}{\Gamma(n + \xi_1 + 1)} (1 + e^{-2ar})^{1+\delta_1} (-e^{-2ar})^{\xi_1} P_n^{(2\xi_1, 2\delta_1+1)}(1 + 2e^{-2ar}) \end{aligned} \tag{80}$$

where

$$\xi_1 = \sqrt{\frac{\ell(\ell + 1) C_0}{4\alpha^2 r_0^2} + \frac{V_2(E_{n,\ell} + Mc^2)}{4\alpha^2 \hbar^2 c^2} - \frac{E^2 - M^2 c^4}{4\alpha^2 \hbar^2 c^2}} \tag{81}$$

and $N_{n,\ell}$ is the normalization constant which can easily be determined in the usual manner.

4.2 Approximate bound state solutions of the Dirac equation for the Rosen-Morse potential for any κ

In this subsection, we consider equations (2), (3) and (4), and on re-writing equations (5) and (6) for the case of equal scalar and vector, i. e. $V(r) = S(r)$, we have the following two coupled differential equations:

$$\left(\frac{d}{dr} - \frac{\kappa}{r} \right) F_{n\kappa}(r) = [Mc^2 + E_{n\kappa}] G_{n\kappa}, \tag{82}$$

$$\left(\frac{d}{dr} + \frac{\kappa}{r} \right) G_{n\kappa}(r) = [Mc^2 - E_{n\kappa}] F_{n\kappa}. \tag{83}$$

With the substitution of equation (82) into equation (83) and taking into consideration the suggestion of Alhaidari et al., (2006), a Schrödinger-like equation for the arbitrary spin-orbit coupling quantum number κ is obtained as

$$\frac{d^2 F_{n\kappa}(r)}{dr^2} + \frac{1}{\hbar^2 c^2} \left\{ [E_{n\kappa}^2 - M^2 c^4] - [Mc^2 + E_{n\kappa}] V(r) - \frac{\hbar^2 c^2 \kappa(\kappa - 1)}{r^2} \right\} F_{n\kappa}(r) = 0. \tag{84}$$

Here, it is observed that equation (84) is identical with equation (75). Therefore, the energy equation of the Dirac equation with the equally mixed Rosen-Morse potential for arbitrary κ -state is obtained as

$$(E_{n\kappa}^2 - M^2c^4) = (E_{n\kappa} + Mc^2)V_2 + \frac{\kappa(\kappa - 1)C_0}{r_0^2}\hbar^2c^2 - 4\alpha^2\hbar^2c^2 \left[\frac{\frac{(C_2 - C_1)}{4\alpha^2r_0^2}\kappa(\kappa - 1) - \frac{(E_{n\kappa} + Mc^2)V_2}{2\alpha^2\hbar^2c^2}}{2(n + \delta_2 + 1)} - \frac{(n + \delta_2 + 1)}{2} \right]^2, \quad (85)$$

where

$$\delta_2 = \frac{1}{2} \left[-1 + \sqrt{1 + \frac{\kappa(\kappa - 1)C_2}{\alpha^2r_0^2} + \frac{4(E_{n\kappa} + Mc^2)V_1}{\alpha^2\hbar^2c^2}} \right]. \quad (86)$$

The associated upper component spinor $F_{n\kappa}(r)$ is obtained as

$$\begin{aligned} F_{n\kappa}(r) &= N_{n\kappa}(1 + e^{-2\alpha r})^{1+\delta_2} (-e^{-2\alpha r})^{\xi_2} {}_2F_1(-n, n + 2(\xi_2 + \delta_2 + 1); 2\xi_2 + 1; -e^{-2\alpha r}) \\ &= N_{n\kappa} \frac{n!\Gamma(2\xi_2 + 1)}{\Gamma(n + \xi_2 + 1)} (1 + e^{-2\alpha r})^{1+\delta_2} (-e^{-2\alpha r})^{\xi_2} P_n^{(2\xi_2, 2\delta_2 + 1)}(1 + 2e^{-2\alpha r}). \end{aligned} \quad (87)$$

On substituting equation (87) into equation (82) and by using the recurrence relation of the hypergeometric function in equation (30), the lower component spinor $G_{n\kappa}(r)$ can be obtained as

$$\begin{aligned} G_{n\kappa}(r) &= \frac{N_{n\kappa}(1 + e^{-2\alpha r})^{1+\delta_2} (-e^{-2\alpha r})^{\xi_2}}{[E_{n\kappa} + Mc^2]} \left[-2\alpha\xi_2 - \frac{2\alpha e^{-2\alpha r}}{1 + e^{-2\alpha r}} - \frac{\kappa}{r} \right] \\ &\quad \times {}_2F_1(-n, n + 2(\xi_2 + \delta_2 + 1); 2\xi_2 + 1; -e^{-2\alpha r}) + \\ &\quad \frac{N_{n\kappa}(1 + e^{-2\alpha r})^{1+\delta_2} (-e^{-2\alpha r})^{\xi_2 + 1}}{[E_{n\kappa} + Mc^2]} \left\{ \frac{2\alpha n [n + 2(\xi_2 + \delta_2 + 1)]}{(2\xi_2 + 1)} \right\} \\ &\quad \times {}_2F_1(-n + 1, n + 2(\xi_2 + \delta_2 + \frac{3}{2}); 2(\xi_2 + 1); -e^{-2\alpha r}), \end{aligned} \quad (88)$$

where

$$\xi_2 = \sqrt{\frac{\kappa(\kappa - 1)C_0}{4\alpha^2r_0^2} + \frac{V_2(E_{n\kappa} + Mc^2)}{4\alpha^2\hbar^2c^2} - \frac{E^2 - M^2c^4}{4\alpha^2\hbar^2c^2}} \quad (89)$$

and $N_{n\kappa}$ is the normalization constant which can easily be determined in the usual manner. Substitution of $F_{n\kappa}(r)$ and $G_{n\kappa}(r)$ into equation (5) gives the bound state spinors of the Dirac equation with the equally mixed Rosen-Morse potential for the arbitrary spin-orbit coupling quantum number κ . In the similar manner, approximate solutions can be obtained when $S(r) = -V(r)$.

5. Conclusions

The approximate analytical solutions of the Dirac equation with the Rosen-Morse potential with arbitrary κ under the pseudospin and spin symmetry conditions have been studied, the standard function analysis approach has been adopted. The Pekeris-type approximation

scheme (a newly improved approximation scheme) has been used for the centrifugal (or pseudo centrifugal) term in order to solve for any values of κ .

Under the PSS and SS conditions, the energy equations, the upper- and the lower-component spinors for the Rosen-Morse potential for any κ have been obtained. The solutions of some special cases are also considered and the energy equations with their associated spinors for the PSS and SS are obtained, these include:

- (i) the s -state solution,
- (ii) the standard Eckart potential,
- (iii) the PT-Symmetric Rosen-Morse potential,
- (iv) the reflectionless-type potential,
- (v) the non-relativistic limit.

Also, in the context of the standard function analysis approach, the approximate bound state solutions of the arbitrary ℓ -state Klein-Gordon and κ -state Dirac equations for the equally mixed Rosen-Morse potential are obtained by introducing a newly improved approximation scheme to the centrifugal term. The approximate analytical solutions with the Dirac-Rosen-Morse potential for any κ or ℓ have been obtained. The upper- and lower-component spinors have been expressed in terms of the hypergeometric functions (or Jacobi polynomials). The approximate analytical solutions obtained in this study are the same with other results available in the literature.

6. Acknowledgments

The author thanks his host Prof. K. D. Sen of the School of Chemistry, University of Hyderabad, India during his TWAS-UNESCO Associate research visit where part of this work was done. Also, he thanks his host Prof. M. N.Hounkonnou (the President of the ICMPA-UNESCO Chair), University of Abomey-Calavi, Republic of Benin where this work has been finalized. Thanks to Ms. Maja Bozicevic for her patience. He acknowledges the University of Ilorin for granting him leave. eJDS (ICTP) is acknowledged. Also, he appreciates the efforts of Profs. Ginocchio, J. N., Dong, S.H., Wei, G.F., Taşkin, F., Grosche, C., Berkdemir, C., Zhang, M. C., Hamzavi and his collaborators for communicating their works to me.

7. References

- [1] Akcay, H. (2007). The Dirac oscillator with a Coulomb-like tensor potential, *Journal of Physics A: Mathematical & Theoretical* Vol. 40: 6427 - 6432.
- [2] Akcay, H. (2009). Dirac equation with scalar and vector quadratic potentials and Coulomb-like tensor potential, *Physics Letters A* Vol. 373: 616 - 620.
- [3] Akcay, H. & Tezcan, C. (2009). Exact solutions of the Dirac equation with harmonic oscillator potential including a Coulomb-like tensor potential, *International Journal of Modern Physics C* Vol. 20 (No. 6): 931 - 940.
- [4] Alberto, P., Fiolhais, M., Malheiro, M., Delfino, A. & Chiapparini, M. (2001). Isospin asymmetry in the pseudospin dynamical symmetry, *Physical Review Letters* Vol. 86 (No. 22): 5015 - 5018.
- [5] Alberto, P., Fiolhais, M., Malheiro, M., Delfino, A. & Chiapparini, M. (2002). Pseudospin symmetry as a relativistic dynamical symmetry in the nucleus, *Physical Review C* Vol. 65: 034307-1 - 034307-9.

- [6] Alhaidari, A. D. , Bahlouli, H. & Al-Hasan, A. (2006). Dirac and Klein-Gordon equations with equal scalar and vector potentials, *Physics Letters A* Vol. 349: 87 - 97.
- [7] Amani, A. R. , Moghrimoazzen, M. A. , Ghorbanpour, H. and Barzegaran, S. (2011). The ladder operators of Rosen-Morse Potential with Centrifugal term by Factorization Method, *African Journal of Mathematical Physics* Vol. 10: 31 - 37.
- [8] Arima, A. , Harvey, M. & Shimizu, K. (1969). Pseudo LS coupling and pseudo SU3 coupling schemes, *Physics Letters B* Vol. 30: 517 – 522.
- [9] Aydoğdu, O. & Sever, R. (2009). Solution of the Dirac equation for pseudoharmonic potential by using the Nikiforov-Uvarov method, *Physica Scripta* Vol. 80: 015001-1 - 015001-6.
- [10] Aydoğdu, O. (2009). Pseudospin symmetry and its applications, *Ph. D. thesis, Middle East Technical University, Turkey*.
- [11] Aydoğdu, O. & Sever, R. (2010a). Exact pseudospin symmetric solution of the Dirac equation for pseudoharmonic potential in the presence of tensor potential, *Few-Body system* Vol. 47: 193 - 200.
- [12] Aydoğdu, O. & Sever, R. (2010b). Exact solution of the Dirac equation with the Mie-type potential under the pseudospin and spin symmetry limit, *Annals of Physics* Vol. 325: 373 - 383.
- [13] Aydoğdu, O. & Sever, R. (2010c). Pseudospin and spin symmetry in the Dirac equation with Woods-Saxon potential and Tensor potential, *European Physical Journal A* Vol. 43: 73 - 81.
- [14] Aydoğdu, O. & Sever, R. (2010d). Pseudospin and spin symmetry for the ring-shaped generalised Hulthén potential, *International Journal of Modern Physics A* Vol. 25 (No. 21): 4067 - 4079.
- [15] Bayrak, O. & Boztosun, I. (2007). The pseudospin symmetric solution of the Morse potential for any κ state, *Journal of Mathematical & Theoretical* Vol. 40: 11119 - 11127.
- [16] Bayrak, O., Soylu, A. & Boztosun, I. (2010). The relativistic treatment of spin-0 particles under the rotating Morse oscillator, *Journal of Mathematical Physics* Vol. 51: 112301-1 - 112301-6.
- [17] Berkdermir, C. (2006). Pseudospin symmetry in the relativistic Morse potential including the spin-orbit coupling term *Nuclear Physics A* Vol. 770: 32 - 39.
- [18] Berkdemir, C. & Cheng, Y. F. (2009). On the exact solutions of the Dirac equation with a novel angle-dependent potential, *Physica Scripta* Vol. 79: 035003-1 - 035005-6.
- [19] Berkdermir, C. (2009). Erratum to “Pseudospin symmetry in the relativistic Morse potential including the spin-orbit coupling term” [*Nuclear Physics A* Vol. 770: 32 - 39; (2006)], *Nuclear Physics A* Vol. 821: 262 - 263.
- [20] Berkdermir, C. & Sever, R. (2009). Pseudospin symmetry solution of the Dirac equation with an angle-dependent potential, *Journal of Physics A: Mathematical & Theoretical* Vol. 41: 0453302-1 - 0453302-11.
- [21] de Castro, A. S., Alberto, P., Lisboa, R. & Malheiro, M. (2006). Relating pseudospin and spin symmetries through charge conjugation and chiral transformations: The case of the relativistic harmonic oscillator, *Physical Review C* Vol. 73: 054309-1 - 054309-13.
- [22] Dong, S. H. (2011). Relativistic treatment of spinless particles subject to a rotating Deng-Fan oscillator, *Communication in Theoretical Physics* Vol. 55 (No. 6): 969 - 971.
- [23] Dong, S. H. (2007): *Factorization Method in Quantum Mechanics (Fundamental Theories of Physics)*, Springer, Netherlands.

- [24] Ginocchio, J. N. (1997). Pseudospin as a relativistic symmetry, *Physical Review Letters* Vol. 78: 436 - 439; A relativistic symmetry in nuclei, *Physics Reports* Vol. 315: 231 - 240.
- [25] Ginocchio, J. N. & Madland, D. G. (1998). Pseudospin symmetry and relativistic single-nucleon wave functions, *Physical Review C* Vol. 57 (No. 3): 1167 - 1173.
- [26] Ginocchio, J. N. (1999). A relativistic symmetry in nuclei, *Physics Reports* Vol. 315: 231 - 240.
- [27] Ginocchio, J. N. (2004). Relativistic harmonic oscillator with spin symmetry, *Physical Review C* Vol. 69: 034318-1 - 034318-8.
- [28] Ginocchio, J. N. (2005a). Relativistic symmetries in nuclei and hadrons, *Physics Reports* Vol. 414 (No. 4-5): 165 - 261.
- [29] Ginocchio, J. N. (2005b). $U(3)$ and Pseudo- $U(3)$ Symmetry of the Relativistic Harmonic Oscillator, *Physical Review Letters* Vol. 95: 252501-1 - 252501-3.
- [30] Gradshteyn, I.S. & Ryzhik, I. M. (2007). *Table of Integrals, Series, and Products*, Academic Press, New York.
- [31] Greene, R. L. & Aldrich, C. (1976). Variational Wave Functions for a Screened Coulomb Potential, *Physics Review A* Vol. 14: 2363 - 2366.
- [32] Greiner, W. (2000). *Relativistic Quantum Mechanics: Wave equations*, Springer, Berlin.
- [33] Grosche, C. & Steiner, F. (1995). How to solve path integrals in quantum mechanics, *Journal of Mathematical Physics* Vol. 36 (No. 5): 2354 - 2386; (1998). *Handbook of Feynman path integrals*, Springer-Verlag, Berlin.
- [34] Guo, J. Y. & Sheng, Z. Q. (2005). Solution of the Dirac equation for the Woods-Saxon potential with spin and pseudospin symmetry, *Physics Letters A'* Vol. 338: 90 - 96
- [35] Guo, J. Y., Wang, R. D. & Fang, X. Z. (2005a). Pseudospin symmetry in the resonant states of nuclei, *Physical Review C* Vol. 72: 054319-1 - 054319-8.
- [36] Guo, J. Y., Fang, X. Z. & Xu, F. X. (2005b). Pseudospin symmetry in the relativistic harmonic oscillator *Nuclear Physics A* Vol.757: 411 - 421.
- [37] Guo, J. Y. and Fang, X. Z. (2006). Isospin dependence of pseudospin symmetry in nuclear resonant states, *Physical Review C* Vol. 74: 024320-1 - 024320-8.
- [38] Guo, J. Y., Zhou, F., Guo, L. F. & Zhou, J. H. (2007). Exact solution of the continuous states for generalized asymmetrical Hartmann potentials under the condition of pseudospin symmetry, *International Journal of Modern Physics* Vol. 22 (No. 26): 4825 - 4832.
- [39] Hamzavi, M., Rajabi, A. A. & Hassanabadi, H. (2010a). Exact spin and pseudospin symmetry solutions of the Dirac equation for Mie-type potential including a Coulomb-like tensor potential, *Few-Body System* Vol. 48: 171 - 183.
- [40] Hamzavi, M., Hassanabadi, H. & Rajabi, A. A. (2010b). Exact solution of Dirac equation for Mie-type potential by using the Nikiforov-Uvarov method under the pseudospin and spin symmetry limit, *Modern Physics Letters A* Vol. 25 (No. 28): 2447 - 2456.
- [41] Hamzavi, M., Rajabi, A. A. & Hassanabadi, H. (2010c). Exact pseudospin symmetry solution of the Dirac equation for spatially-dependent mass Coulomb potential including a Coulomb-like tensor interaction via asymptotic iteration method, *Physics Letters A* Vol. 374: 4303 - 4307.
- [42] Hecht, K. T. & Adler, A. (1969). Generalized seniority for favored $J \neq 0$ pair in mixed configurations, *Nuclear Physics A* Vol. 137: 129 - 143.
- [43] Ibrahim, T. T., Oyewumi, K. J. & Wyngaardt, S. M. (2011). Approximate solution of N-dimensional relativistic wave equations, submitted for publication.

- [44] Ikhdair, S. M.(2010). Approximate solutions of the Dirac equation for the Rosen-Morse potential including the spin-orbit centrifugal term, *Journal of Mathematical Physics* Vol. 51: 023525-1 - 023525-16.
- [45] Ikhdair, S. M.(2011). An approximate κ state solutions of the Dirac equation for the generalized Morse potential under spin and pseudospin symmetry, *Journal of Mathematical Physics* Vol. 52: 052303-1 - 052303-22.
- [46] Ikhdair, S. M., Berkdermir, C. & Sever, R. (2011). Spin and pseudospin symmetry along with orbital dependency of the Dirac-Hulthén problem, *Applied Mathematics and Computation* Vol. 217: 9019 - 9032.
- [47] Ikot, A. N. & Akpabio, L. E. (2010). Approximate solution of the Schrödinger equation with Rosen-Morse potential including the centrifugal term, *Applied Physics Research* Vol. 2 (No. 2): 202 - 208.
- [48] Jia, C. S., Guo, J. P. & Pend, X. L. (2006). Exact solution of the Dirac-Eckart problem with spin and pseudospin symmetry, *Journal of Physics A: Mathematical & General* Vol. 39: 7737 - 7744.
- [49] Jia, C. S., Li, S. C., Li, Y. & Sun, L. T. (2002). Pseudo-Hermitian potential models with PT symmetry, *Physics Letters A* Vol. 300: 115 -121.
- [50] Jia, C. S., Chen, T. & Cui, L. G. (2009b). Approximate analytical solutions of the Dirac equation with the generalized pöschl-Teller potential including the pseudo-centrifugal term, *Physics Letters A* Vol. 373: 1621 - 1626.
- [51] Jia, C. S., Liu, J. Y. , Wang, P. Q. & Lin, X. (2009b). Approximate analytical solutions of the Dirac equation with the hyperbolic potential in the presence of the spin symmetry and pseudo-spin symmetry, *International Journal of Theoretical Physics* Vol. 48: 2633 - 2643.
- [52] Landau, L. D. and Lifshitz, E. M. (1999): *Quantum Mechanics (Non-relativistic Theory): Course of Theoretical Physics*, Butterworth-Heinemann, Oxford.
- [53] Lisboa, R., Malheiro, M. & Alberto, P. (2004a). The nuclear pseudospin symmetry along an isotopic chain, *Brazilian Journal of Physics* Vol. 34 (No. 1A): 293 - 296.
- [54] Lisboa, R., Malheiro, M., de Castro, A. S., Alberto, P. & Fiolhais, M. (2004b). Pseudospin symmetry and the relativistic harmonic oscillator, *Physical Review C* Vol. 69: 024319-1 - 024319-15.
- [55] Lisboa, R., Malheiro, M., de Castro, A. S., Alberto, P. & Fiolhais, M. (2004c). Harmonic oscillator and nuclear pseudospin, *Proceedings of American Institute of Physics, IX Hadron Physics & VII Relativistic Aspects of Nuclear Physics: A joint meeting on QCD & QGP* in the edited by M. E. Bracco, M. Chiapparini, E. Ferreira & T. Kodama, AIP, New York, pp. 569 - 571.
- [56] Lu, J. (2005). Analytic quantum mechanics of diatomic molecules with empirical potentials, *Physics Scripta* Vol. 72: 349 - 352.
- [57] Merzbacher, E. (1998). *Quantum Mechanics*, John Wiley, New York.
- [58] Meng, J. & Ring, P. (1996). Relativistic Hartree-Bogoliubov description of the neutron halo in ^{11}Li , *Physical Review Letters* Vol. 77: 3963 - 3966.
- [59] Meng, J., Sugarwara-Tanabe, K., Yamaji, S. & Arima, A. (1998). Pseudospin symmetry in relativistic mean field theory, *Physical Review C* Vol. 58: R628 - R631.
- [60] Meng, J., Sugarwara-Tanabe, K., Yamaji, S. & Arima, A. (1999). Pseudospin symmetry in Zr and Sn isotopes from the proton drip line to the neutron drip line, *Physical Review C* Vol.59: 154 - 163.

- [61] Oyewumi, K. J. & Akoshile, C. A. (2010). Bound-state solutions of the Dirac-Rosen-Morse potential with spin and pseudospin symmetry, *European Physical Journal A* Vol. 45: 311 - 318.
- [62] Page, P. R., Goldman, T. & Ginocchio, J. N. (2001). Relativistic symmetry suppresses Quark spin-orbit splitting, *Physical Review Letters* Vol. 86: 204 - 207.
- [63] Pekeris, C. L. (1934). The rotation-vibration coupling in diatomic molecules, *Physical Review* Vol. 45: 98 - 103.
- [64] Rosen, N. & Morse, P. M. (1932). On the Vibrations of Polyatomic Molecules, *Physics Review* Vol. 42 (No. 2): 210 - 217.
- [65] Setare, M. R. & Nazari, Z. (2009). Solution of Dirac equations with five-parameter exponent-type potential, *Acta Physica Polonica B* Vol. 40 (No. 10): 2809 - 2824.
- [66] Soylu, A., Bayrak, O. and Boztosun, I. (2007). An approximate solution of the Dirac-Hultén problem with pseudospin and spin symmetry for any κ state, *Journal Mathematical Physics* Vol. 48: 082302-1 - 082302-9.
- [67] Soylu, Bayrak, O. and Boztosun, I. (2008a). κ state solutions of the Dirac equation for the Eckart potential with pseudospin and spin symmetry, *Journal of Physics. A: Mathematical & Theoretical* Vol. 41: 065308-1 - 065308-8.
- [68] Soylu, Bayrak, O. and Boztosun, I. (2008b). Kappa state solutions of Dirac-Hultén and Dirac-Eckart problems with pseudospin and spin symmetry, *Proceedings of American Institute of Physics, Nuclear Physics and Astrophysics: From Stable beams to Exotic Nuclei* edited by I. Boztosun & A. B. Balantekin, AIP, New York, pp. 322 - 325.
- [69] Soylu, A., Bayrak, O. & Boztosun, I. (2008c). Exact solutions of Klein-Gordon equation with scalar and vector Rosen-Morse type potentials, *Chinese Physics Letters* Vol. 25 (No. 8): 2754 - 2757.
- [70] Stuchbery, A. E. (1999). Magnetic behaviour in the pseudo-Nilsson model, *Journal of Physics G* Vol. 25: 611 - 616.
- [71] Stuchbery, A. E. (2002). Magnetic properties of rotational states in the pseudo-Nilsson model, *Nuclear Physics A* Vol. 700: 83 - 116.
- [72] Taşkin, F. (2009). Approximate solutions of the Dirac equation for the Manning-Rosen potential including the spin-orbit coupling term, *International Journal of Theoretical Physics* Vol. 48: 1142 - 1149.
- [73] Troltenier, D., Nazarewicz, W., Szymanski, Z., & Draayer, J. P. (1994). On the validity of the pseudo-spin concept for axially symmetric deformed nuclei, *Nuclear Physics A* Vol. 567: 591 - 610
- [74] Wei, G. F. & Dong, S. H. (2008). Approximately analytical solutions of the Manning-Rosen potential with the spin-orbit coupling term and spin symmetry, *Physics Letters A* Vol. 373: 49 - 53.
- [75] Wei, G. F. & Liu, X. Y. (2008). The relativistic bound states of the hyperbolic potential with the centrifugal term *Physica Scripta*, Vol. 78: 065009-1 - 065009-5
- [76] Wei, G. F. & Dong, S. H. (2009). Algebraic approach to pseudospin symmetry for the Dirac equation with scalar and vector modified Pöschl-Teller potentials, *European Physical Letters* Vol. 87: 40004-p1 - 40004-p6.
- [77] Wei, G. F. & Dong, S. H. (2010a). Pseudospin symmetry in the relativistic Manning-Rosen Potential to the pseudo-centrifugal term, *Physics Letters B* Vol. 686: 288 - 292.
- [78] Wei, G. F. & Dong, S. H. (2010b). Pseudospin symmetry for modified Rosen-Morse potential including a Pekeris-type approximation to the pseudo-centrifugal term, *European Physical Journal A* Vol. 46: 207 - 212.

- [79] Wei, G. F. & Dong, S. H. (2010c). A novel algebraic approach to spin symmetry for Dirac equation with scalar and vector second Pöschl-Teller potentials, *European Physical Journal A* Vol. 43: 185 - 190.
- [80] Wei, G. F. & Dong, S. H. (2010d). Spin symmetry in the relativistic symmetrical well potential including a proper approximation to the spin-orbit coupling term, *Physica Scripta* Vol. 81: 035009-1 - 035009-5.
- [81] Wei, G. F., Duan, X. Y. & Liu, X. Y. (2010). Algebraic approach to spin symmetry for the Dirac equation with the trigonometric Scarf potential, *International Journal of Modern Physics A* Vol. 25(No. 8): 1649 - 1659.
- [82] Xu, Q. & Zhu, S. J. (2006). Pseudospin symmetry and spin symmetry in the relativistic Woods-Saxon, *Nuclear Physics A* Vol. 768: 161 -169.
- [83] Xu, Y., He, S. & Jia, C. S.(2008). Approximate analytical solutions of the Dirac equation with the Pöschl-Teller potential including the spin-orbit coupling term, *Journal of Physics A: Mathematical & Theoretical* Vol. 41: 0255302-1 - 255302-8.
- [84] Xu, Y., He, S. & Jia, C. S. (2010). Approximate analytical solutions of the Klein-Gordon equation with the Pöschl-Teller potential including the centrifugal term' *Physica Scripta*, Vol. 81: 045001-1 - 045001-7
- [85] Yi, L. Z., Diao, Y. F., Liu, J. Y. & Jia, C. S. (2004). Bound states of the Klein-Gordon equation with vector and scalar Rosen-Morse potentials, *Physics Letters A* Vol. 333: 212 - 217.
- [86] Zhang, M. C. (2009). Pseudospin symmetry and a double ring-shaped spherical harmonic oscillator potential, *Central European Journal of Physics* Vol. 7(No. 4): 768 - 773. Pseudospin symmetry for a ring-shaped non-spherical harmonic oscillator potential, *International Journal of Theoretical Physics*, Vol 48: 2625 - 2632.
- [87] Zhang, L. H., Li, X. P. & Jia, C. S. (2008). Analytical approximation to the solution of the Dirac equation with the Eckart potential including the spin-orbit coupling term, *Physics Letters A* Vol. 372: 2201 - 2207.
- [88] Zhang, M. C., Huang-Fu, G. Q. & An, B. (2009a). Pseudospin symmetry for a new ring-shaped non-spherical harmonic oscillator potential, *Physica Scripta* Vol. 80: 065018-1 - 065018-5
- [89] Zhang, L.H, Li, X. P. & Jia, C. S. (2009b). Approximate analytical solutions of the Dirac equation with the generalized Morse potential model in the presence of the spin symmetry and pseudo-spin symmetry, *Physica Scripta* Vol. 80: 035003-1 - 0035003-6.
- [90] Zhao, X. Q., Jia, C. S. & Yang, Q. B. (2005). Bound states of relativistic particles in the generalized symmetrical double-well potential, *Physics Letters A*, Vol. 337: 189 - 196.

Quantum Mechanics Entropy and a Quantum Version of the H-Theorem

Paul Bracken
Department of Mathematics,
University of Texas, Edinburg, TX
 USA

1. Introduction

Entropy is a fundamental concept which emerged along with other ideas during the development of thermodynamics and statistical mechanics Landau and Lifshitz (1978); Lieb and Yngvason (1999). Entropy has developed foremost out of phenomenological thermodynamical considerations such as the second law of thermodynamics in which it plays a prominent role Wehrl (1978). With the intense interest in the investigation of the physics of matter at the atomic and subatomic quantum levels, it may well be asked whether this concept can emerge out of the study of systems at a more fundamental level. In fact, it may be argued that a correct definition is only possible in the framework of quantum mechanics, whereas in classical mechanics, entropy can only be introduced in a rather limited and artificial way. Entropy relates macroscopic and microscopic aspects of nature, and ultimately determines the behavior of macroscopic systems. It is the intention here to present an introduction to this subject in a readable manner from the quantum point of view. There are many reasons for undertaking this. The intense interest in irreversible thermodynamics Grössing (2008), the statistical mechanics of astrophysical objects Padmanabhan (1990); Pathria (1977), quantum gravity and entropy of black holes Peres & al. (2004), testing quantum mechanics Ballentine (1970) and applications to condensed matter and quantum optics Haroche & al. (2006); Raimond & al. (2001) are just a few areas which are directly or indirectly touched on here.

Let us begin by introducing the concept of entropy from the quantum mechanical perspective, realizing that the purpose is to focus on quantum mechanics in particular. Quantum mechanics makes a clear distinction between observables and states. Observables such as position and momentum are mathematically described by self-adjoint operators in a Hilbert space. States, which are generally mixed, can be described by a density matrix, which is designated by ρ throughout. This operator ρ is Hermitean, has trace one and yields the expectation value of an observable A in the state ρ through the definition

$$\langle A \rangle = \text{Tr}(\rho A). \quad (1.1)$$

Entropy is not an observable, so there does not exist an operator with the property that its expectation value in some state would be the entropy. In fact, entropy is a function of state. If

the given state is described by the density matrix ρ , its entropy is defined to be

$$S(\rho) = -k_B \text{Tr}(\rho \log(\rho)). \quad (1.2)$$

This formula is due to von Neumann (1955), and generalizes the classical expression of Boltzmann and Gibbs to the quantum regime. Of course, k_B is Boltzmann's constant, and the natural logarithm is used throughout. If k_B is put equal to one, the entropy becomes dimensionless. Thus, entropy is a well-defined quantity, no matter what size or type of system is considered. It is always greater than or equal to zero, and equal to zero exactly for pure states.

It will be useful to give some interpretation of von Neumann's formula. The discovery for which Boltzmann is remembered is his formula for entropy which appeared in 1877, namely,

$$S = k_B \log(W), \quad (1.3)$$

This form for S was established by making a connection between a generalization S of thermodynamic entropy and the classical H -function. The identification of the constant on the right of (1.3) as Boltzmann's was proposed by Planck. Equation (1.3) taken in conjunction with the H-theorem, interprets the second law, $\Delta S \geq 0$, simply as the tendency of an isolated system to develop from less probable states to more probable states; that is, from small W to large W . Thermodynamic equilibrium corresponds to the state in which W attains its maximum value. In fact, equation (1.3) has had far reaching consequences. It led Planck, for example, to his quantum hypothesis, which is that the energy of radiation is quantized, and then from there to the third law of thermodynamics. The H-theorem provided an explanation in mechanical terms of the irreversible approach of macroscopic systems towards equilibrium. By correlating entropy with the H-function and thermodynamic probability, Boltzmann revealed the statistical character of the second law. Of course, Boltzmann was restricted to a classical perspective. The question as to whether the number of microstates makes literal sense classically has been discussed as an objection to his approach. As stated by Pauli (2000), a microstate of a gas for example is defined as a set of numbers which specify in which cell each atom is located, that is, a number labeling the atom, an index for the cell in which atom s is located and a label for the microstate. The macrostate is uniquely determined by the microstate, however the converse does not hold. For every macrostate there are very many microstates, as will be discussed. Boltzmann's fundamental hypothesis is then: All microstates are equally probable.

However, as Planck anticipated, in quantum mechanics such a definition immediately makes sense. There is no ambiguity at all, as there is a natural idea of microstate. The number of microstates may be interpreted as the number of pure states with some prescribed expectation values. Suppose there are W different pure states in a system, each occurring with the same probability. Then the entropy is simply $S = \log(W)$. However, the density matrix of the system is given by $\rho = (1/W)\mathcal{P}$, where \mathcal{P} is a W -dimensional projection operator. Thus, the correspondence follows immediately, that is, $\log W = -\text{Tr}[\rho \log \rho]$.

Each density matrix can be diagonalized Wehrl (1978),

$$\rho = \sum_k p_k |k\rangle\langle k|, \quad (1.4)$$

where $|k\rangle$ is a normalized eigenvector corresponding to the eigenvalue p_k and $|k\rangle\langle k|$ is a projection operator onto $|k\rangle$ with $p_k \geq 0$ and $\sum_k p_k = 1$. Here the coefficients are positive probabilities and not complex amplitudes as in a quantum mechanical superposition. Substituting (1.4) into (1.2) finally yields,

$$S(\rho) = - \sum_k p_k \log(p_k). \quad (1.5)$$

There is a more combinatorial approach Wehrl (1978). This will come up again subsequently when ensembles take the place of a density operator. If N measurements are performed, one will obtain as a result that for large N , the system is found $p_1 N$ times in $|1\rangle$, $p_2 N$ times in state $|2\rangle$ and so on, all having the same weight. By straightforward counting, there results

$$W_N = \frac{N!}{(p_1 N)!(p_2 N)! \dots}. \quad (1.6)$$

When $N \rightarrow \infty$, Stirling's formula can be applied to the logarithm of (1.6) so the entropy is

$$\log \frac{N!}{n_1! n_2! \dots} = N \log(N) - N - \sum_j (n_j \log n_j - n_j) = -N \sum_j p_j \log(p_j). \quad (1.7)$$

Dividing both sides of (1.7) by N , then as $N \rightarrow \infty$ (1.5) is recovered. It should also be noted that (1.5) is of exactly the same form as Shannon entropy, which can be thought of as a measure of unavailable information.

Of course, another way to look at this is to consider N copies of the same Hilbert space, or system, in which there are microstates $|1\rangle \otimes |2\rangle \dots$ such that $|1\rangle$ occurs $p_1 N$ times, $|2\rangle$ occurs $p_2 N$ times, and so forth. Again (1.6) is the result, and according to Boltzmann's equation, one obtains $\log(W_N)$ for the entropy as in (1.5). In (1.5), S is maximum when all the p_j are equal to $1/N$.

By invoking the constraint $\sum_k p_k = 1$, (1.5) takes the form

$$S = - \sum_{k=1}^{N-1} p_k \log(p_k) - p_N \log(p_N), \quad (1.8)$$

where $p_N = 1 - \sum_{k=1}^{N-1} p_k$, and all other p_k are considered to be independent variables. Differentiating S in (1.8), it is found that

$$\frac{\partial S}{\partial p_k} = -\log(p_k) + \log(p_N).$$

This vanishes of course when $p_k = p_N = N^{-1}$ and this solution is the only extremum of S .

To summarize, entropy is a measure of the amount of chaos or lack of information about a system. When one has complete information, that is, a pure state, the entropy is zero. Otherwise, it is greater than zero, and it is bigger the more microstates exist and the smaller their statistical weight.

2. Basic properties of entropy

There are several very important properties of entropy function (1.5) which follow from simple mathematical considerations and are worth introducing at this point Peres (1995).

The first point to make is that the function $S(\mathbf{p})$ is a concave function of its arguments $\mathbf{p} = (p_1, \dots, p_N)$. For any two probability distributions $\{p_j\}$ and $\{q_j\}$, and any $\lambda \in [0, 1]$, S defined in (1.5) satisfies the following inequality

$$S(\lambda \mathbf{p} + (1 - \lambda) \mathbf{q}) \geq \lambda S(\mathbf{p}) + (1 - \lambda) S(\mathbf{q}), \quad \lambda \in [0, 1]. \quad (2.1)$$

This can be proved by differentiating S twice with respect to λ to obtain,

$$\frac{d^2 S(\lambda \mathbf{p} + (1 - \lambda) \mathbf{q})}{d\lambda^2} = - \sum_j \frac{(p_j - q_j)^2}{\lambda p_j + (1 - \lambda) q_j} \leq 0. \quad (2.2)$$

This is a sufficient condition for a function to be concave. Equality holds only when $p_j = q_j$, for all j . The physical meaning of inequality (2.1) is that mixing different probability distributions can only increase uniformity.

If N is the maximum number of different outcomes obtainable in a test of a given quantum system, then any test that has exactly N different outcomes is called a maximal test, called T here. Suppose the probabilities p_m for the outcomes of a maximal test T which can be performed on that system are given. It can be shown that this entropy never decreases if it is elected to perform a different maximal test. The other test may be performed either instead of T , or after it, if test T is repeatable.

To prove this statement, suppose the probabilities for test T are $\{p_m\}$ and those for a subsequent test are related to the $\{p_m\}$ by means of a doubly stochastic matrix $P_{\mu m}$. This is a matrix which satisfies $\sum_\mu P_{\mu m} = 1$ and $\sum_m P_{\mu m} = 1$. In this event,

$$q_\mu = \sum_m P_{\mu m} p_m$$

are the probabilities for the subsequent test. The new entropy is shown to satisfy the inequality $S(\mathbf{q}) \geq S(\mathbf{p})$. To prove this statement, form the difference of these entropies based on (1.5),

$$\begin{aligned} \sum_m p_m \log(p_m) - \sum_\mu q_\mu \log(q_\mu) &= \sum_m p_m (\log(p_m) - \sum_\mu P_{\mu m} \log(q_\mu)) \\ &= \sum_{m\mu} p_m (P_{\mu m} \log(p_m) - P_{\mu m} \log(q_\mu)) \\ &= \sum_{m\mu} p_m P_{\mu m} \log\left(\frac{p_m}{q_\mu}\right). \end{aligned}$$

In the second line, $\sum_\mu P_{\mu m} = 1$ has been substituted to get this result. Using the inequality $\log x \geq 1 - x^{-1}$, where equality holds when $x = 1$, and the fact that S has a negative sign, it follows that

$$S(\mathbf{q}) - S(\mathbf{p}) \geq \sum_{m\mu} p_m P_{\mu m} \left(1 - \frac{q_\mu}{p_m}\right) = \sum_{m\mu} (p_m P_{\mu m} - q_\mu P_{\mu m}) = \sum_\mu (q_\mu - q_\mu \sum_m P_{\mu m}) = 0. \quad (2.3)$$

The equality sign holds if and only if $P_{\mu m}$ is a permutation matrix, so the sets are identical. After a given preparation whose result is represented by a density matrix ρ , different tests correspond to different sets of probabilities, and therefore to different entropies. The entropy of a preparation can be defined as the lowest value attained by (1.5) for any complete test performed after that preparation. The optimal test which minimizes S is shown to be the one that corresponds to the orthonormal basis v_μ given by the eigenvectors of the density matrix ρ

$$\rho v_\mu = w_\mu v_\mu.$$

In this basis, ρ is diagonal and the eigenvalues w_μ satisfy $0 \leq w_\mu \leq 1$ and $\sum_\mu w_\mu = 1$. A basic postulate of quantum mechanics asserts that the density matrix ρ completely specifies the statistical properties of physical systems that were subjected to a given preparation. All the statistical predictions that can be obtained from (1.1) for an operator are the same as if we had an ordinary classical mixture, with a fraction w_μ of the systems with certainty in the state v_μ . Therefore, if the maximal test corresponding to the basis v_μ is designed to be repeatable, the probabilities w_μ remain unchanged and entropy S remains constant. The choice of any other test can only increase the entropy, as in the preceding result. This proves that the optimal test, which minimizes the entropy, is the one corresponding to the basis that diagonalizes the density matrix.

The entropic properties of composite systems obey numerous inequalities as well. Let $\{v_m\}$ and $\{e_\mu\}$ be two orthonormal basis sets for the same physical system. Let $\rho = \sum w_m |v_m\rangle\langle v_m|$ and $\sigma = \sum \omega_\mu |e_\mu\rangle\langle e_\mu|$ be two different density matrices. Their relative entropy $S(\sigma|\rho)$ is defined to be

$$S(\sigma|\rho) = \text{Tr}[\rho(\log \rho - \log \sigma)]. \quad (2.4)$$

Let us evaluate $S(\sigma|\rho)$ in (2.3) in the $|v_\mu\rangle$ basis where ρ is diagonal. The diagonal elements of $\log \sigma$ are

$$(\log \sigma)_{mm} = \langle v_m, \sum_\mu \log \omega_\mu |e_\mu\rangle\langle e_\mu| v_m \rangle = \sum_\mu \log \omega_\mu |\langle e_\mu, v_m \rangle|^2 = \sum_\mu \log \omega_\mu P_{\mu m}. \quad (2.5)$$

The matrix $P_{\mu m}$ is doubly stochastic, so as in (2.3) we have

$$S(\sigma|\rho) = \sum_m w_m (\log w_m - \sum_\mu P_{\mu m} \log \omega_\mu) = \sum_{m\mu} w_m P_{\mu m} \log\left(\frac{w_m}{\omega_\mu}\right) \geq 0. \quad (2.6)$$

Equality holds in (2.6) if and only if $\sigma = \rho$.

Inequality (2.6) can be used to prove a subadditivity inequality. Consider a composite system, with density matrix ρ , then the reduced density matrices of the subsystems are called ρ_1 and ρ_2 . Then matrices ρ , ρ_1 and ρ_2 satisfy,

$$S(\rho) \leq S(\rho_1) + S(\rho_2). \quad (2.7)$$

This inequality implies that a pair of correlated systems involves more information than the two systems separately.

To prove this, suppose that w_m , ω_μ and $W_{m\mu} = w_m \omega_\mu$ are the eigenvalues of ρ_1 , ρ_2 and $\rho_1 \otimes \rho_2$, respectively, then

$$\sum_m w_m \log w_m + \sum_\mu \omega_\mu \log \omega_\mu = \sum_{m\mu} W_{m\mu} \log W_{m\mu}.$$

This has the equivalent form,

$$S(\rho_1) + S(\rho_2) = S(\rho_1 \otimes \rho_2).$$

Consider now the relative entropy

$$S(\rho_1 \otimes \rho_2 | \rho) = \text{Tr}[\rho(\log \rho - \log \rho_1 \otimes \rho_2)] = \text{Tr}[\rho(\log \rho - \log \rho_1 - \log \rho_2)].$$

It has just been shown that relative entropy is nonnegative, so it follows from this that

$$\text{Tr}(\rho \log \rho) \geq \text{Tr}(\rho \log \rho_1) + \text{Tr}(\rho \log \rho_2).$$

Since $\text{Tr}(\rho \log \rho_1) = \sum_{m\mu, n\nu} \rho_{m\mu, n\nu} (\log \rho_1)_{nm} \delta_{\nu\mu} = \text{Tr}(\rho_1 \log \rho_1)$, and similarly for $\text{Tr}(\rho \log \rho_2)$, it follows that

$$\text{Tr}(\rho \log \rho) \geq \text{Tr}(\rho_1 \log \rho_1) + \text{Tr}(\rho_2 \log \rho_2).$$

Now using (1.2), it follows that

$$-S(\rho) \geq -S(\rho_1) - S(\rho_2).$$

Multiplying both sides by minus one, (2.7) follows.

3. Entanglement and entropy

The superposition principle applied to composite systems leads to the introduction of the concept of entanglement Mintet & al. (2005); Raimond & al. (2001), and provides an important application for the density matrix. A very simple composite object is a bipartite quantum system S which is composed of two parts A and B . The states of A and B belong to two separate Hilbert spaces called \mathcal{H}_A and \mathcal{H}_B which are spanned by the bases $|i_A\rangle$ and $|i_B\rangle$, and may be discrete or continuous. If A and B are prepared independently of each other and are not coupled together at some point, S is described by the tensor product $|\psi_S\rangle = |\psi_A\rangle \otimes |\psi_B\rangle$. Each subsystem is described by a well-defined wave function. Any manipulation of one part leaves the measurement prediction for the other part unchanged. System S can also be prepared by measuring joint observables, which act simultaneously on A and B . Even if S has been prepared by measuring separate observables, A and B can become coupled by means of an interaction Hamiltonian. In this instance, it is generally impossible to write the global state $|\psi_S\rangle$ as a product of partial states associated to each component of S .

This is what the expression *quantum entanglement* means. The superposition principle is at the heart of the most intriguing features of the microscopic world. A quantum system may exist in a linear superposition of different eigenstates of an observable, suspended between different classical realities, as when one says a particle can be at two positions at the same time. It seems to be impossible to get a classical intuitive representation of superpositions. When the superposition principle is applied to composite systems, it leads to the concept of entanglement. Moreover, as Bell has shown, entanglement cannot be consistent with any local theory containing hidden variables.

Even if the state S cannot be factorized according to the superposition principle, it can be expressed as a sum of product states $|i_A\rangle \otimes |i_B\rangle$, which make up a basis of the global Hilbert

space, \mathcal{H}_S . Consequently, an entangled state can be expressed as

$$|\psi_S\rangle = \sum_{i,\mu} \alpha_{i\mu} |i_A\rangle \otimes |\mu_B\rangle \neq |\psi_A\rangle \otimes |\psi_B\rangle, \quad (3.1)$$

where the $\alpha_{i\mu}$ are complex amplitudes. The states $|\psi_S\rangle$ contain information not only about the results of measurements on A and B separately, but also on correlations between these measurements. In an entangled state, each part loses its quantum identity. The quantum content of the global state is intricately interwoven between the parts. Often it is the case that there is interest in carrying out measurements on one part without looking at another part. For example, what is the probability of finding a result when measuring observable O_A attached to subsystem A , without worrying about B . The complete wave function $|\psi_S\rangle$ can be used to predict the experimental outcomes of the measurement of $O_A \otimes \mathbf{1}_B$. This can also be done by introducing the density operator ρ_S of a system described by the quantum state $|\psi_S\rangle$, which is just the projector

$$\rho_S = |\psi_S\rangle\langle\psi_S|. \quad (3.2)$$

It has the same information content as $|\psi_S\rangle$, and for all predictions on S , all quantum rules can be expressed in such a fashion; for example, the expectation values of an observable O_S of S is found by (1.1). The probability of finding the system in $|i\rangle$ after a measurement corresponding to the operator $\rho_i = |i\rangle\langle i|$ is given by $|\langle i|\psi_S\rangle|^2$ in the quantum description and $\text{Tr}(\rho_i\rho_S)$ in terms of the density matrix.

The density operator approach is very advantageous for describing one subsystem, A , without looking at B . A partial density operator ρ_A can be determined which has all the predictive information about A alone, by tracing ρ_S over the subspace of B

$$\rho_A = \text{Tr}_B(\rho_S) = \sum_{i,i',\mu} \alpha_{i\mu} \alpha_{i'\mu}^* |i_A\rangle\langle i'_A|. \quad (3.3)$$

Thus, the probability of finding A in state $|j_A\rangle$ is found by computing the expectation value of the projector $\rho_j = |j_A\rangle\langle j_A|$, which is $\pi_j = \text{Tr}(\rho_A\rho_j)$. Predictions on A can be done without considering B . The information content of ρ_A is smaller than in ρ_S , since correlations between A and B are omitted. To say that A and B are entangled is equivalent to saying that ρ_A and ρ_B are not projectors on a quantum state. There is however a basis in \mathcal{H}_A in which ρ_A is diagonal. Let us call it $|j_A\rangle$, so that ρ_A is given by

$$\rho_A = \sum_j \lambda_j |j_A\rangle\langle j_A|. \quad (3.4)$$

In (3.4), λ_j are positive or zero eigenvalues which sum to one. By neglecting B , there is acquired only a statistical knowledge of state A , with a probability λ_j of finding it in $|j_A\rangle$.

It is possible to express the state for S in a representation which displays the entanglement. The superposition (3.1) claims nothing as to whether the state can be factored. To put this property in evidence, choose a basis in \mathcal{H}_A , called $|j_A\rangle$ in which ρ_A is diagonal. Then (3.1) is written

$$|\psi_S\rangle = \sum_j |j_A\rangle |\tilde{j}_B\rangle, \quad (3.5)$$

where state $|\tilde{j}_B\rangle$ is given by

$$|\tilde{j}_B\rangle = \sum_{\mu} \alpha_{j\mu} |\mu_B\rangle. \quad (3.6)$$

The $|\tilde{j}_B\rangle$ are mirroring in \mathcal{H}_B the basis of orthonormal states in \mathcal{H}_A in which ρ_A is diagonal. These mirror states are also orthogonal to each other as can be seen by expressing the fact that ρ is diagonal

$$\langle j_A | \rho_A | j'_A \rangle = \lambda_j \delta_{jj'} = \langle \tilde{j}_B | \tilde{j}'_B \rangle.$$

At this point, the mirror state can be normalized by means of the transformation $|\hat{j}_B\rangle = |\tilde{j}_B\rangle / \sqrt{\lambda_j}$ giving rise to the Schmidt expansion,

$$|\psi_S\rangle = \sum_j \sqrt{\lambda_j} |j_A\rangle |\hat{j}_B\rangle. \quad (3.7)$$

The sum over a basis of product mirror states exhibits clearly the entanglement between A and B . The symmetry of this expression shows that ρ_A and ρ_B have the same eigenvalues. Any pure entangled state of a bipartite system can be expressed in this way. Now a measure of the degree of entanglement can be defined using the density matrix. As the λ_j become more spread out over many non-zero values, more information is lost by concentrating on one system and disregarding correlations between A and B . This loss of mutual information can be linked to the degree of entanglement. This information loss could be measured by calculating the von Neumann entropy of A or B from (1.5)

$$S_A = S_B = - \sum_j \lambda_j \log(\lambda_j) = -\text{Tr}(\rho_A \log \rho_A) = -\text{Tr}(\rho_B \log \rho_B). \quad (3.8)$$

This is the entropy of entanglement $S_e = S_A = S_B$, and it expresses quantitatively the degree of disorder in our knowledge of the partial density matrices of the two parts of the entangled system S .

If the system is separable, then one λ_j is non-zero and $S_e = 0$, so maximum information on the states of both parts obtains. As soon as two λ_j are non-zero, S_e becomes strictly positive and A and B are entangled. The maximum entropy, hence maximum entanglement obtains when the λ_j are equally distributed among the A and B subspaces. It is maximal and equal to $\log N_A$, when ρ_A is proportional to $\mathbf{1}_A$, that is $\rho_A = \mathbf{1}_A / N_A$. In a maximally entangled state, local measurements performed on one part of the system are not predictable at all. What can be predicted are the correlations between the measurements performed on both parts. For example, consider a bipartite system in which one part has dimension two. There are only two λ -values in the Schmidt expansion, and satisfy $\lambda_1 + \lambda_2 = 1$. Then from (1.5), the entropy when $\lambda_1 \in (0, 1)$ is,

$$S_e = -\lambda_1 \log(\lambda_1) - (1 - \lambda_1) \log(1 - \lambda_1). \quad (3.9)$$

The degree of entanglement is equal to zero when $\lambda_1 = 0$ or 1 and passes through a maximum at $\lambda_1 = 1/2$ at which $S_e = 1$. The degree of entanglement measured by the von Neumann entropy is invariant under local unitary transformations acting on A or B separately, a direct consequence of the invariance of the spectrum of the partial density operators.

Consider the case of a two-level system with states $|0\rangle$ and $|1\rangle$, where the density matrix is a two-by-two hermitean matrix given by

$$\rho_A = \begin{pmatrix} \rho_{00} & \rho_{01} \\ \rho_{10} & \rho_{11} \end{pmatrix}. \quad (3.10)$$

The entropy can be calculated for this system. Its positive diagonal terms are the probabilities of finding the system in $|0\rangle$ or $|1\rangle$ and they sum to one. The nondiagonal terms satisfy $\rho_{01} = \rho_{10}^*$ and are zero for a statistical mixture of $|0\rangle$ and $|1\rangle$. Since ρ_A is a positive operator

$$|\rho_{10}| = |\rho_{01}| \leq \sqrt{\rho_{00}\rho_{11}}.$$

is satisfied, and the upper bound is reached for pure states.

The density matrix ρ_A can be expanded with real coefficients onto the operator basis made up of the identity matrix \mathbf{I} and the Pauli matrices σ_i

$$\rho_A = \frac{1}{2}(\mathbf{I} + \mathbf{R} \cdot \boldsymbol{\sigma}), \quad (3.11)$$

where $\mathbf{R} = (u, v, w)$ is three-dimensional and $\boldsymbol{\sigma} = (\sigma_x, \sigma_y, \sigma_z)$. The components of \mathbf{R} are linked to the elements of the density matrix as follows

$$u = \rho_{10} + \rho_{01}, \quad v = i(\rho_{01} - \rho_{10}), \quad w = \rho_{00} - \rho_{11}.$$

The modulus R of \mathbf{R} satisfies $R \leq 1$, equality holding only for pure states. This follows from $\text{Tr}(\rho_A^2) \leq 1$. If nonlinear functions of an observable A are defined as $f(A) = \sum f(a_k)|e_k\rangle\langle e_k|$, the von Neumann entropy of ρ is

$$S = -\frac{1+R}{2} \log\left(\frac{1+R}{2}\right) - \frac{1-R}{2} \log\left(\frac{1-R}{2}\right). \quad (3.12)$$

To each density matrix ρ_A , the end of the vector \mathbf{R} can be located on the surface of a sphere. The surface of the sphere $R = 1$ is the set of pure states with $S = 0$. The statistical mixtures correspond to inside the sphere $R < 1$. The closer the point to the center, the larger the von Neumann entropy. The center of the sphere corresponds to the totally unpolarized maximum entropy state.

Any mixed state can be represented in an infinite number of ways as a statistical mixture of two pure states, since any \mathbf{P} with its end inside the sphere can be expressed as a vector sum of a \mathbf{P}_1 and \mathbf{P}_2 whose ends are at the intersection of the sphere with an arbitrary line passing by the extreme end of \mathbf{P} , so one can write $\mathbf{P} = \lambda\mathbf{P}_1 + (1-\lambda)\mathbf{P}_2$ for $0 < \lambda < 1$. The density matrix which is a linear function of \mathbf{P} is then a weighted sum of the projectors on the pure states $|u_1\rangle$ and $|u_2\rangle$ corresponding to \mathbf{P}_1 and \mathbf{P}_2 ,

$$\rho_A = \frac{1}{2}[\mathbf{I} + \lambda\mathbf{P}_1 \cdot \boldsymbol{\sigma} + (1-\lambda)\mathbf{P}_2 \cdot \boldsymbol{\sigma}] = \lambda|u_1\rangle\langle u_1| + (1-\lambda)|u_2\rangle\langle u_2|. \quad (3.13)$$

Thus, there exists an ambiguity of representation of the density operator which, if $P \neq 0$, can be lifted by including the condition that $|u_1\rangle$ and $|u_2\rangle$ be orthogonal.

Before finishing, it is worth discussing the following application, which seems to have very important ramifications. A violation of the second law arises if nonlinear modifications are

introduced into Schrödinger's equation Weinberg (1989). A nonlinear Schrödinger equation does not violate the superposition principle in the following sense. The principle asserts that the pure states of a physical system can be represented by rays in a complex linear space, but does not demand that the time evolution obeys a linear equation. Nonlinear variants of Schrödinger's equation can be created with the property that if $u(0)$ evolves to $u(t)$ and $v(0)$ to $v(t)$, the pure state represented by $u(0) + v(0)$ does not evolve into $u(t) + v(t)$, but into some other pure state.

The idea here is to show that such a nonlinear evolution violates the second law of thermodynamics. This is provided the other postulates of quantum mechanics remain as they are, and that the equivalence of the von Neumann entropy to ordinary entropy is maintained. Consider a mixture of quantum systems which are represented by a density matrix

$$\rho = \lambda \Pi_u + (1 - \lambda) \Pi_v, \quad (3.14)$$

where $0 < \lambda < 1$ and Π_u, Π_v are projection operators on the pure states u and v . In matrix form the density matrix is represented as

$$\rho = \begin{pmatrix} \lambda & \lambda \langle v|u \rangle \\ (1 - \lambda) \langle u|v \rangle & 1 - \lambda \end{pmatrix}.$$

The eigenvalues are found by solving the polynomial $\det(\rho - w\mathbf{1}) = 0$ for the eigenvalues w . Setting $x = |\langle u, v \rangle|^2$, they are given by

$$w_j = \frac{1}{2} \pm \left[\frac{1}{4} - \lambda(\lambda - 1)(1 - x) \right]^{1/2}, \quad j = 1, 2. \quad (3.15)$$

The entropy of this mixture is found by putting w_j into (1.5)

$$S = -w_1 \log(w_1) - w_2 \log(w_2). \quad (3.16)$$

The polynomial $p(\lambda) = 4\lambda(1 - \lambda)$ has range $(0, 1)$ when $\lambda \in (0, 1)$, so it follows that $s = 4\lambda(1 - \lambda)(1 - x) \in (0, 1)$ as well. Setting $f = 1 - s$, then when $s \in (0, 1)$, the derivative of (3.16) is given by

$$\begin{aligned} \frac{\partial S}{\partial x} &= - \frac{\lambda(1 - \lambda)}{\sqrt{1 - 4\lambda(1 - \lambda)(1 - x)}} \log\left(\frac{(1 + \sqrt{f})^2}{4\lambda(1 - \lambda)(1 - x)}\right) \\ &= - \frac{\lambda(1 - \lambda)}{\sqrt{1 - s}} \log\left(\frac{(1 + \sqrt{1 - s})^2}{s}\right) < 0. \end{aligned}$$

Consequently, if pure quantum states evolve as $u(0) \rightarrow u(t)$ and $v(0) \rightarrow v(t)$, the entropy of the mixture ρ shall not decrease provided that $x(t) \leq x(0)$, or in terms of the definition of x , $|\langle u(t), v(t) \rangle|^2 \leq |\langle u(0), v(0) \rangle|^2$. If say $\langle u(0), v(0) \rangle = 0$, then also $\langle u(t), v(t) \rangle = 0$, so orthogonal states remain orthogonal. Consider now a complete orthogonal set u_k . For every v ,

$$\sum_k |\langle u_k, v \rangle|^2 = 1.$$

If there exists m such that $|\langle u_m(t), v(t) \rangle|^2 < |\langle u_m(0), v(0) \rangle|^2$, there must also exist some n for which the reverse holds, $|\langle u_n(t), v(t) \rangle|^2 > |\langle u_n(0), v(0) \rangle|^2$. In this event, the entropy of a

mixture of u_n and v will spontaneously decrease in a closed system, which is in violation of the second law of thermodynamics. To retain the law, $|\langle u(t), v(t) \rangle|^2 = |\langle u(0), v(0) \rangle|^2$ must hold for every u and v . From Wigner's theorem, the mapping $v(0) \rightarrow v(t)$ is unitary, so Schrödinger's equation must be linear if the other postulates of quantum mechanics remain fixed.

4. Ensemble methods in quantum mechanics

In classical mechanics, one relinquishes the idea of a description of the microscopic mechanical states of trillions of microscopic interacting particles by instead computing averages over a virtual ensemble of systems which replicate the real system. Quantum theory is faced with a similar problem, and the remedy takes the form of the Gibbs ensemble. This last section will take a slightly different track and discusses ensemble theory in quantum mechanics. Two of the main results will be to produce a quantum version of the H-Theorem, and to show how the quantum mechanical canonical ensemble can be formulated.

An astronomic number of states, or of microstates, is usually compatible with a given set of macroscopic parameters defining a macrostate of a thermophysical system. Consequently, a virtual quantum mechanical ensemble of systems is invoked, which is representative of the real physical system. The logical connection between a physical system and ensemble is made by requiring the time average of a mechanical property G of a system in thermodynamic equilibrium equal its ensemble average calculated with respect to an ensemble made up of $N^* \rightarrow \infty$ systems representing the actual system

$$\bar{G} = \langle G \rangle. \quad (4.1)$$

The ensemble average $\langle G \rangle$ is the ordinary mean of G over all the systems of the ensemble. If N_r^* systems are in a state with eigenvalue G_r corresponding to G ,

$$N^* \langle G \rangle = \sum_r N_r^* G_r, \quad (4.2)$$

where the sum is over all allowed states.

Adopt as a basic set the states $\psi_{jrm\dots}$ uniquely identifiable by the quantum numbers j, r, m, \dots referring to a set of compatible properties. A particular system of the ensemble will not permanently be in one of these states $\psi_{jrm\dots}$, as there exists only a probability to find a system in any one. Let us compress the basic states to read ψ_{jr} if we let r stand for the entire collection of quantum numbers r, m, \dots . These cannot strictly be eigenstates of the total energy, since a system occupying a particular eigenstate of its total Hamiltonian H at any one moment will remain in this state forever. The state of the real system, which the ensemble is to represent, is a superposition of eigenstates belonging to the same or different values of the energy. To obtain an ensemble where the individual members are to change, we suppose the basic set ψ_{jr} is made up of eigenstates of the unperturbed Hamiltonian H^0 . Assume it is possible to write

$$H = H^0 + H^1, \quad (4.3)$$

such that H^1 is a small perturbation added to the unperturbed Hamiltonian H^0 , and vary with the physical system considered.

Suppose E_j^0 are the eigenvalues of the unperturbed H^0 and ψ_{jr}^0 the eigenstates corresponding to them, where r again denotes a set of compatible quantum numbers. Introducing H^1 now changes the energy eigenvalues and energy eigenfunctions by an amount E_{jr}^1 and ψ_{jr}^1 , which should be very small compared with the unperturbed values. It is precisely the eigenstates ψ_{jr}^0 of H^0 rather than H that are used as basic states for the construction of the ensemble. Since these for the most part will appear in what follows, we continue to omit the superscript for both the eigenfunctions ψ_{jr} and eigenvalues E_{jr} whenever the situation indicates that unperturbed quantities are intended. A perturbed system finding itself initially in any one of the unperturbed states ψ_{jr} does not remain indefinitely in this state, but will continually undergo transitions to other unperturbed states ψ_{ks} due to the action of the perturbation H^1 . In analogy with a classical system, a quantum ensemble is described by the number of systems N_{jr}^* in each state ψ_{jr} . The probability P_{jr} of finding a system, selected at random from the ensemble, in the state ψ_{jr} is clearly

$$P_{jr} = \frac{N_{jr}^*}{N^*}. \quad (4.4)$$

The quantities N_{jr}^* must sum up to N^* ,

$$\sum_{jr} N_{jr}^* = N^*, \quad \sum_{jr} P_{jr} = 1. \quad (4.5)$$

An ensemble can be representative of a physical system in thermodynamic equilibrium only in this context if the occupation numbers N_{jr}^* are constants. A more general picture could consider the occupation numbers as functions of time $N_{jr}^* = N_{jr}^*(t)$. The ensemble corresponds to a system removed from equilibrium. Let us ask then how do the N_{jr}^* vary with time.

Quantum mechanics claims the existence of $A_{ks}^{jr}(t)$ which determine the probability of a system in state ψ_{jr} at time zero to be in ψ_{ks} at time t . The final state could correspond to the initial state. Since $N_{jr}^*(0)$ systems are in a state specified by quantum numbers jr at $t = 0$, $A_{ks}^{jr}(t)N_{jr}^*(0)$ systems will make the transition from jr to ks during $(0, t)$. The number of systems in ks at time t will be

$$N_{ks}^*(t) = \sum_j \sum_r A_{ks}^{jr}(t) N_{jr}^*(0). \quad (4.6)$$

The $A_{ks}^{jr}(t)$ must satisfy the condition $\sum_j \sum_r A_{ks}^{jr}(t) = 1$. Multiplying this by $N_{ks}^*(0)$ and subtracting from (4.6) gives

$$N_{ks}^*(t) - N_{ks}^*(0) = \sum_j \sum_r A_{ks}^{jr}(t) [N_{jr}^*(0) - N_{ks}^*(0)]. \quad (4.7)$$

This is the change in occupation number over $(0, t)$. Dividing (4.7) by N^* and using (4.4) gives

$$P_{ks}(t) - P_{ks}(0) = \sum_j \sum_r A_{ks}^{jr}(t) [P_{jr}(0) - P_{ks}(0)]. \quad (4.8)$$

A stationary ensemble or one in statistical equilibrium defined as $N_{ks}^*(t) = N_{ks}^*(0)$ for all ks holds when $N_{jr}^*(0) = N_{ks}^*(0)$, at least when $A_{ks}^{jr}(t) \neq 0$. The contribution to the right side of (4.8) comes from an extremely narrow interval $\Delta E = 2\hbar/t$ centered at $E_j = E_k$, as indicated by

perturbation theory. In this interval, it can be assumed $P_{jr}(0)$ depends on the j -index weakly enough that we can use $P_{ks}(0)$ in their place, so the term in brackets in (4.8) does not depend on j . The energy spectrum is very nearly continuous for a thermophysical system, so the sum over j can be approximated by an integral over E . This implies an approximation of the form

$$\sum_j A_{ks}^{jr}(t) = tW_{sr}^{(k)}. \quad (4.9)$$

The quantities $W_{sr}^{(k)}$ are time independent provided H^1 is time independent. Consequently, they are nonnegative and depend only on the displayed indices. Substituting (4.9) and $P_{jr}(0) = P_{kr}(0)$ into (4.8) gives

$$\frac{1}{t}[P_{ks}(t) - P_{ks}(0)] = \sum_r W_{sr}^{(k)} [P_{kr}(0) - P_{ks}(0)]. \quad (4.10)$$

In the limit when t becomes arbitrarily small, (4.10) can be approximated by expanding about $t = 0$ on the left to give the final result for the time rate of change of the probability P_{ks} ,

$$\dot{P}_{ks} = \sum_r W_{sr}^{(k)} [P_{kr}(0) - P_{ks}(0)]. \quad (4.11)$$

This equation was first derived by *W. Pauli*, and will lead to a quantum version of the H-Theorem next. It signifies that of the $N^*P_{kr}(0)$ systems occupying state kr at $t = 0$, $N^*P_{kr}(0)W_{sr}^{(k)}$ will, per unit time, go over to ks . Thus, the $W_{ks}^{(k)}$ are interpreted as transition probabilities per unit time that the system will go from state kr to ks . They must satisfy $W_{sr}^{(k)} \geq 0$ and the symmetry conditions $W_{rs}^{(k)} = W_{sr}^{(k)}$. This is also referred to as the principle of microscopic reversibility.

4.1 A quantum H-theorem

The ensemble which represents a real physical system is determined by the thermodynamic state and environment of the actual system. The virtual ensemble has constituents which must duplicate both aspects. Of great practical interest and the one considered here is the case of isolated systems. An isolated system is characterized not only by a fixed value of the energy E , but also by a definite number of particles and volume V . Under these conditions, a quantum H-theorem can be formulated Yourgrau et al. (1966). Classically the error with which the energy of the real system can be specified can be theoretically reduced to zero. However, quantum theory claims there is a residual error specified by the uncertainty relation. All members of the ensemble cannot be said then to occupy eigenstates belonging to the same energy. It must be assumed the systems are distributed over energy levels lying within a finite range, ΔE . The following restrictions on the occupation numbers of the ensemble are imposed for an isolated system

$$N_{jr}^* \neq 0, \quad E_j \in I_{\Delta E} = (E - \frac{1}{2}\Delta E, E + \frac{1}{2}\Delta E), \quad N_{jr}^* = 0, \quad E_j \notin I_{\Delta E}. \quad (4.12)$$

It will be shown that the ensemble specified by (4.12) exhibits a one-directional development in time ending ultimately in equilibrium.

Pauli's equation can be used to obtain the rate of change of the quantum mechanical H -function which is defined to be

$$H^*(t) = \sum_s P_s \log(P_s). \quad (4.13)$$

The summation in (4.13) is extended over the group of states whose energies are approximately E , that is in the interval $I_{\Delta E}$ for example. Now, differentiate (4.13) with respect to t and use the fact that $\sum_s P_s = 1$ to get

$$\dot{H}^* = \sum_s \dot{P}_s \log(P_s) + \sum_s \dot{P}_s = \sum_s \dot{P}_s \log(P_s). \quad (4.14)$$

Now requiring that \dot{P}_s be determined by (4.11), \dot{H}^* in (4.14) becomes

$$\dot{H}^*(t) = \sum_s \sum_r W_{sr} (P_r - P_s) \log(P_s). \quad (4.15)$$

Interchanging r and s and using the symmetry property $W_{rs} = W_{sr}$, this is

$$\dot{H}^*(t) = \sum_r \sum_s W_{rs} (P_s - P_r) \log(P_r) = - \sum_r \sum_s W_{sr} (P_r - P_s) \log(P_r). \quad (4.16)$$

Adding (4.15) and (4.16) yields the following result,

$$\dot{H}^*(t) = -\frac{1}{2} \sum_r \sum_s W_{sr} (P_r - P_s) (\log(P_r) - \log(P_s)). \quad (4.17)$$

Recalling that $W_{sr} \geq 0$ as well as the inequality $(x - y)(\log x - \log y) \geq 0$ for each (r, s) , it follows that $(P_r - P_s)(\log(P_r) - \log(P_s)) \geq 0$. Consequently, each term in the sum in (4.17) is either zero or positive, hence $H^*(t)$ decreases monotonically with time,

$$\dot{H}^*(t) \leq 0. \quad (4.18)$$

Equality holds if and only if $P_s = P_r$ for all pairs (r, s) such that $W_{sr} \neq 0$. Thus H^* decreases and statistical equilibrium is reached only when this condition is fulfilled. Originally enunciated by Boltzmann in a classical context, (4.18) constitutes a quantum mechanical version of the H-theorem.

4.2 Quantum mechanical canonical ensemble

Let us devise an ensemble which is representative of a closed isothermal system of given volume, or characterized by definite values of the parameters T , V and N . This approach brings us back to one of the ways entropy was formulated in the introduction, and need not rely on the specification of a density matrix. Suppose there are N^* members of the ensemble each with the same values of V and N as the real system. However, they are not completely isolated from each other, so each is surrounded by a surface that does not permit the flow of particles but is permeable to heat. The collection of systems can be packed into the form of a lattice and the entire construction immersed in a heat reservoir at temperature T until equilibrium is attained. The systems are isothermal such that each is embedded in a heat reservoir composed of the remaining $N^* - 1$.

Once the ensemble is defined, it can be asked which fraction of the N^* systems occupies any particular eigenstate of the unperturbed Hamiltonian of the experimental system. Let us study the ensemble then which is regarded as a large thermophysical system having energy E^* , volume $V^* = N^*V$ and made up of N^*N particles. The quantum states of this large supersystem belonging to energy E^* are to be enumerated. The thermal interaction energy is assumed to be so small that a definite energy eigenstate can be assigned to each individual system at any time. As energy can be exchanged between constituent systems, the eigenstates accessible to them do not pertain to one value of energy. The energy eigenstates of a system are written $E_1, E_2, \dots, E_j, \dots$ with $E_{j+1} \geq E_j$. Only one system-state j belongs to energy eigenvalue E_j . An energy eigenstate of the supersystem is completely defined once the energy eigenstate occupied by each system is specified.

It is only needed to stipulate the number N_j^* of systems occupying every system state j . Any set of values of the occupation numbers N_1^*, N_2^*, \dots define a quantum mechanical distribution. Clearly the W^* supersystem states calculated by

$$W(N_1^*, N_2^*, \dots) = \frac{N^*!}{N_1^*! N_2^*! \dots} \quad (4.19)$$

are compatible with a given distribution N_1^*, N_2^*, \dots . Not all sets of N_j^* are admissible. The physically relevant ones satisfy the two constraints

$$\sum_j N_j^* = N^*, \quad \sum_j N_j^* E_j = E^*. \quad (4.20)$$

The supersystem then consists of a number N^* of fixed but arbitrary systems with a constant energy E^* .

The number of physically possible supersystem states is clearly given as

$$\Omega^*(E^*, N^*) = \sum_C W^*(N_1^*, N_2^*, \dots), \quad (4.21)$$

where the summation is to be extended over all N_j^* satisfying constraints (4.20). According to the earlier postulate, all allowed quantum states of an isolated system are equiprobable. Consequently, from this principle all states which satisfy (4.20) occur equally often. The probability P^* that a particular distribution N_1^*, N_2^*, \dots is actualized is the quotient of W^* and Ω^* ,

$$P^*(N_1^*, N_2^*, \dots) = \frac{W^*(N_1^*, N_2^*, \dots)}{\Omega^*(E^*, N^*)}. \quad (4.22)$$

With respect to P^* in (4.22), the average value of the occupation number N_k^* is given quite simply by

$$\bar{N}_k^* = \sum_k N_k^* P^*(N_1^*, N_2^*, \dots). \quad (4.23)$$

Substituting P^* into (4.23), it can be written as

$$\Omega^*(E^*, N^*) \bar{N}_k^* = N^* \sum_k \frac{(N^* - 1)!}{N_1^*! N_2^*! \dots (N_k^* - 1)! \dots}. \quad (4.24)$$

To obtain a more useful expression for \bar{N}_k^* , the right-hand side can be transformed to a set of primed integers. To this end, define

$$N^{*'} = N^* - 1, \quad N_k^{*'} = N_k^* - 1, \quad N_j^{*'} = N_j^*, \quad j \neq k.$$

Using these, constraints (4.20) get transformed into

$$\begin{aligned} \sum N_j^{*'} &= N_1^* + N_2^* + \cdots + (N_j^* - 1) + \cdots = N^* - 1, \\ \sum N_j^{*'} E_j &= N_1^* E_1 + \cdots + (N_k^* - 1) E_k + \cdots = E^* - E_k. \end{aligned} \quad (4.25)$$

Consequently,

$$\Omega^*(E^*, N^*) = N^* \sum' \frac{N^{*'}!}{N_1^{*'}! N_2^{*'}! \cdots'} \quad (4.26)$$

where the prime means the sum extends over all $N_k^{*'}$ which satisfy constraints (4.25). Comparing (4.26) with (4.20), the right-hand side of (4.26) is exactly $N^* \Omega^*(E^* - E_k, N^* - 1)$. Thus dividing by $\Omega^*(E^*, N^*)$, we have

$$\bar{N}_k^* = \frac{N^* \Omega^*(E^* - E_k, N^* - 1)}{\Omega^*(E^*, N^*)}.$$

Dividing this by N^* and taking the logarithm of both sides results in the expression,

$$\log \frac{\bar{N}_k^*}{N^*} = \log \Omega^*(E^* - E_k, N^* - 1) - \log \Omega^*(E^*, N^*). \quad (4.27)$$

The result in (4.27) can be expanded in a Taylor series to first order if we take $N^* \gg 1$ and $E^* \gg E_k$,

$$\log \frac{\bar{N}_k^*}{N^*} = -\frac{\partial \log \Omega^*}{\partial E^*} E_k - \frac{\partial \log \Omega^*}{\partial N^*} = -\beta E_k^* - \alpha. \quad (4.28)$$

From the constraint $N^* = \sum_j \bar{N}_j^* = N^* e^{-\alpha} \sum e^{-\beta E_j}$, e^α can be obtained. Replacing this back in (4.28) and exponentiating gives

$$\bar{N}_k^* = N^* \frac{e^{-\beta E_k}}{\sum_k e^{-\beta E_j}}. \quad (4.29)$$

The result in (4.29) gives what the average distribution of systems over system states will be in a supersystem at equilibrium. The instantaneous distribution will fluctuate around this distribution. The relative fluctuations of the occupation numbers for large enough N^* are negligible, so to this accuracy, \bar{N}_k^*/N^* can be equated to P_k . Setting $Z = \sum_j e^{-\beta E_j}$, the instantaneous probability that an arbitrarily chosen system of this supersystem will be in system state k can be summarized as follows

$$P_k = Z^{-1} e^{-\beta E_k}. \quad (4.30)$$

This distribution is the quantum version of the canonical distribution in phase space, and is referred to as the quantum mechanical canonical ensemble. The function Z so defined is called the partition function.

In effect, this formalism has permitted the construction of a type of measuring device. Let us show that the microscopic ideas which have led to these results immediately imply consequences at the macroscopic level. To this end, it will be established what the exact form of the connection between Z and the Helmholtz free energy F actually is. The starting point is the second part of (4.20). Putting $U = E^*/N^*$, it implies

$$U = \sum_j P_j E_j. \quad (4.31)$$

Formula (4.31) is in agreement with the postulate maintaining that the energy U of the physical system must be identified with the ensemble average $\langle E \rangle$ of the energy.

Begin by considering the change dU of the energy U when the experimental system remains closed but undergoes an infinitesimal reversible process. Equation (4.31) implies that

$$dU = \sum_j (E_j dP_j + P_j dE_j). \quad (4.32)$$

Now (4.30) can be solved for E_j in the form $E_j = -\beta^{-1}(\log Z + \log P_j)$. Consequently, since $\sum_j P_j = 1$, it is found that $\sum_j dP_j = 0$. Combining these it then follows that

$$-\sum_j E_j dP_j = \beta^{-1} \sum_j (\log Z + \log P_j) dP_j = \beta^{-1} \sum_j \log P_j dP_j = \beta^{-1} d\left(\sum_j P_j \log P_j\right). \quad (4.33)$$

Further, with $-\delta W$ the work done on the system during the given process, we have that

$$\sum_j P_j dE_j = -\delta W, \quad (4.34)$$

Combining (4.33) and (4.34), we get the result

$$dU = -\beta^{-1} d\left(\sum_j P_j \log P_j\right) - \delta W. \quad (4.35)$$

Comparing (4.35) with the first law $dU = \delta Q - \delta W$, it is asserted that

$$\beta \delta Q = -d\left(\sum_j P_j \log P_j\right). \quad (4.36)$$

Since the right-hand side of (4.36) is an exact differential, it is concluded that β is an integrating factor for δQ . By the second law of thermodynamics, β must be proportional to T^{-1} and the proportionality constant must be the reciprocal of k_B . With β of this form, when combined with the second law $\delta Q = T dS$, we have

$$dS = -k_B d\left(\sum_j P_j \log P_j\right). \quad (4.37)$$

This can be easily integrated to give

$$S = -k_B \sum_j P_j \log P_j + C, \quad (4.38)$$

where the integrating constant C is independent of both T and V . In fact the additive property of entropy requires that $C = 0$.

This complicated procedure has returned us in some sense to where we began with (1.5), but by a different route. To get a relation between Z and F , use (4.30), (4.31) and (4.38) to write

$$TS = -k_B T \sum_j P_j \log P_j = k_B T \log Z + \sum_j P_j E_j = k_B T \log Z + U. \quad (4.39)$$

Consequently, since $F = U - TS$, (4.39) implies the following result

$$F = -k_B T \log Z. \quad (4.40)$$

Through the construction of these ensembles at a fundamental quantum level, a formalism has been obtained which will allow us to obtain concrete predictions for many equilibrium thermodynamic properties of a system once the function $Z = Z(T, V, N)$ is known. In fact, it follows from the thermodynamic equation

$$dF = -S dT - p dV + \mu dN, \quad (4.41)$$

where μ is the chemical potential per molecule, that

$$S = -\left(\frac{\partial F}{\partial T}\right)_{V,N} = k_B \log Z + k_B T \left(\frac{\partial Z}{\partial T}\right)_{V,N}, \quad (4.42)$$

$$p = -\left(\frac{\partial F}{\partial V}\right)_{N,T} = k_B T \left(\frac{\partial Z}{\partial V}\right)_{N,T},$$

$$\mu = \left(\frac{\partial F}{\partial N}\right)_{T,V} = -k_B T \left(\frac{\partial \log Z}{\partial N}\right)_{T,V},$$

$$U = F + TS = k_B T^2 \left(\frac{\partial \log Z}{\partial T}\right)_{V,N}. \quad (4.43)$$

As an application of these results, consider the one-dimensional harmonic oscillator which has quantum mechanical energy eigenvalues given by

$$\epsilon_n = \left(n + \frac{1}{2}\right) \hbar \omega, \quad n = 0, 1, 2, \dots \quad (4.44)$$

The single-oscillator partition function is given by

$$z(\beta) = \sum_{n=0}^{\infty} e^{-\beta(n+\frac{1}{2})\hbar\omega} = (2 \sinh(\frac{1}{2}\beta\hbar\omega))^{-1}.$$

The N -oscillator partition function is then given by

$$Z_N(\beta) = [z(\beta)]^N = (2 \sinh(\frac{1}{2}\beta\hbar\omega))^{-N}. \quad (4.45)$$

The Helmholtz free energy follows from (4.40),

$$F = Nk_B T \log(2 \sinh(\frac{1}{2}\beta\hbar\omega)).$$

By means of F , (4.42) and (4.43) imply that $\mu = F/N$, $p = 0$ and the entropy and energy are

$$S = Nk_B \left[\frac{\beta \hbar \omega}{e^{\beta \hbar \omega} - 1} - \log(1 - e^{-\beta \hbar \omega}) \right], \quad U = N \left[\frac{1}{2} \hbar \omega + \frac{\hbar \omega}{e^{\beta \hbar \omega} - 1} \right]. \quad (4.46)$$

5. Conclusions

It has been seen that formulating the concept of entropy at the microscopic level can be closely related to studying the foundations of quantum mechanics. Doing so provides a useful formalism for exploring many complicated phenomena such as entanglement at this level. Moreover, predictions can be established which bridge a gap between the microscopic and the macroscopic realm. There are many other topics which branch out of this introduction to the subject. For example there is a great deal of interest now in the study of the quantization of nonintegrable systems Gutzwiller (1990), which has led to the field of quantum chaos. There are many indications of links in this work between the areas of nonintegrability and the kind of ergodicity assumed in statistical mechanics which should be pursued.

6. References

- Ballentine L. (1970). The Statistical Interpretation of Quantum Mechanics, *Reviews of Modern Physics*, 42, 358-381.
- Grossing G. (2008). The vacuum fluctuation theorem: Exact Schrödinger equation via nonequilibrium thermodynamics, *Physics Letters*, B 372, 4556-4563.
- Gutzwiller M. (2009). *Chaos in Classical and Quantum Mechanics*, Springer-Verlag, NY.
- Haroche S. and Raimond J. (2006). *Exploring the Quantum*, Oxford University Press.
- Landau L. and Lifshitz E. (1978). *Statistical Physics*, Pergamon Press.
- Lieb E. and Yngvason J. (1999). The physics and mathematics of the second law of thermodynamics, *Physics Reports*, 310, 1-96.
- Mintet F., Carvalho A., Kees M. and Buchleitner A. (2005). Measures and dynamics of entangled states, *Physics Reports*, 415, 207-259.
- von Neumann J. (1955). *Mathematical Foundations of Quantum Mechanics*, translated by R. T. Beyer, Princeton University Press, Princeton, NJ.
- Padmanabhan T. (1990). Statistical Mechanics of self gravitating systems, *Physics Reports*, 188, 285-362.
- Pathria R. (1977). *Statistical Mechanics*, Pergamon Press.
- Pauli W. (2000). *Statistical Mechanics, Pauli Lectures on Physics*, vol. 4, Dover, Mineola, NY.
- Peres A. (1995). *Quantum Theory: Concepts and Methods*, Kluwer Academic Publishers, Dordrecht, The Netherlands.
- Peres A. and Terno D. (2004). Quantum Information and Relativity Theory, *Reviews of Modern Physics*, 76, 93-123.
- Raimond J., Brune M. and Haroche S. (2001). Manipulating quantum entanglement with atoms and photons in a cavity, *Reviews of Modern Physics*, 73, 565-582.
- Rajeev S. (2008). Quantization of contact manifolds and thermodynamics, *Annals of Physics*, 323, 768-782.
- Wehrl A. (1978). General Properties of Entropy, *Reviews of Modern Physics*, 50, 221-260.
- Weinberg S. (1989). Testing Quantum Mechanics, *Annals of Physics*, 194, 336-386.

Yourgrau W., van der Merwe A. and Raw G., (1982). *Treatise on Irreversible and Statistical Thermophysics*, Dover, Mineola, NY.

Correction, Alignment, Restoration and Re-Composition of Quantum Mechanical Fields of Particles by Path Integrals and Their Applications

Francisco Bulnes
*Technological Institute of High Studies of Chalco
Mexico*

1. Introduction

In the universe all the phenomena of physical, energetic and mental nature coexist of functional and harmonic management, since they are interdependent ones; for example to quantum level a particle have a harmonic relation with other or others, that is to say, each particle has a correlation energy defined by their energy density $K_{\alpha\beta}$, which relates the transition states ϕ_{α} and ϕ_{β} , of a particle to along of the time.

There is an infinite number of paths of this kind Γ , in the space-time of the phenomena to quantum scale, that permits the transition or impermanence of the particles, that is to say, these can change from wave to particle and vice versa, or suffer energetic transmutations due to the existing relation between matter and energy, and of themselves in their infinity of the states of energy. Of this form we can realize calculations, which take us to the determination of amplitudes of transition inside a range of temporary equilibrium of the particles, that is to say, under the constant action of a field, which in this regime, remains invariant under proper movements in the space-time. Then exist a *Feynman integral* that extends on the space of continuous paths or re-walked Γ , that joins both correlated transition states. Likewise, if $\mathbb{R}^d \times I_t$, is the space-time where happens these transitions, and u, v , are elements of this space, the integral of all the continuous possible paths in $\mathbb{R}^d \times I_t$ is

$$\mathfrak{A}(L, x(t)) = \int_{C^{u,v}[0,t]} \exp\left\{\frac{i}{\hbar}(Action)(x)\right\} Dx, \quad (1)$$

where \hbar , is the constant of Max Planck, and the $(Action)$, is the realized by their *Lagrangian L*. Nevertheless, this temporal equilibrium due to the space-time between particles can turn aside, and even get lost (suffer scattering) in the expansion of the space-time when the trajectory that joins the transition states gets lost, this due to the absence of correlation of the particles, or of an adequate correlation, whose transition states do not turn out to be related, or turn out to be related in incorrect form. From a deep point of view of the knowledge of the matter, this succeeds when the chemical links between the atoms weaken and break, or get lost for lack of an electronic exchange adapted between these (*process electrons emission-*

reception). All this brings with it a disharmony matter-energy producing *collateral damage* between the immensity of interacting particles whose effects are a distortion of the field created by them. Finally these effects become visible in the matter under structural deformations or production of defective matter.

To eliminate this distortion of the field is necessary to remember the paths and to continue them of a systematised form through of *certain path or route integrals* (that belongs to a class of integral of the type (1)), that re-establishes normal course of the particles, re-integrating their field (realising the sum of all the trajectories that conform the movement of the particle), eliminating the deviations (that can derive in knots or ruptures in the space-time) that previously provoked this disequilibrium. These knots or ruptures in the space-time will be called singularities of the field.

In quantum mechanics, the spectral and vibration knowledge of the field of particles in the space, facilitates the application of corrective and restorer actions on the same field using their space of energy states through of the meaning of their electromagnetic potentials studied in quantum theory (*Aharonov-Bohm effect*). Thus these electromagnetic potentials can be re-interpreted in a spectral and vibration space that can be formulated in a set of continuous paths or re-walked, with the goal of realising corrective and restorers applications of the field, stretch to stretch, section for section, and that is inherent in this combined effect of all the possible trajectories to carry a particle from a point to other. By gauge theory is licit and consistent to manipulate the actions of correction and restoration of the field through of electromagnetic field, which ones are gauge fields of several types of interactions both strong and weak. In this last point is necessary to mention that in the class of equivalence of the electrodynamics potentials can be precisely re-interpreted like a connection on a trivial bundle of lines of $SU(2)$ (*non-Abelian part of the gauge theory using electromagnetic fields*), and admitting non-trivial bundles of lines with connection provided with more general fields (as for example, the of curvature, or the corresponding to $SU(3)$ (*the strong interactions*)). In both cases they are considered to be the phases of the corresponding functions of wave local variables and constant actions can be established across of their correspondents Lagrangians. *The path integrals* to these cases are of the same form that (1), except from the consideration of the potential states in each case. Into of this electromagnetic context and from the point of view of the solution of the wave equation through the alignments of lines of field, we can use the corresponding homogeneous bundle of lines that are used to give adequate potentials (potential module gauge, for example, those who come from the *cohomology* of $O(n-2)$, $n \geq 1$ (Bulnes & Shapiro, 2007). Of this management we can establish that $\{set\ of\ fields\ of\ particles\} \cong I^{\alpha\beta}(H^1(PM^{\pm}, O(-n-2)))$, where $\{potentials\}/\{gauge\} \cong H^1(PM^{\pm}, O(-n-2))$, (Bulnes & Shapiro, 2007). Here $I^{\alpha\beta}(H^1(PM^{\pm}, O(-n-2)))$, is the *cohomological class of the spectral images of the integrals of line* on the corresponding homogeneous bundle $O(-n-2)$.

Generalising the path integrals (1), we can establish that an evaluation of a global action \mathfrak{I} , due to the law of movement established for an operator L , that act on the space of particles $x(s)$, comes given for

$$\mathfrak{I}: x(s) \mapsto \int_M L(X(s)) d(x(s)), \quad (2)$$

where $M (\cong \mathbb{R}^d \times I_t)$, is the space-time of the transitions of the particles $x(s)$.

In particular, if we want the evaluation of this action to along of certain elected trajectory (path), inside of the field of minimal trajectories that governs the principle of minimal action

established by L , in our integrals (2), we have the execution of the action in a path Γ , given, to know

$$\text{Exe: } \mathfrak{Z}(x(s)) \mapsto \int_{\Gamma} \left\{ \int_M L(X(s))d(x(s)) \right\} \mu_s = \int_{\Gamma} \mathfrak{Z}(x(s))\mu_s, \quad (3)$$

where μ_s , the corresponding measure on the path or trajectory Γ , in M , is. The study of this integrals and their applications in the re-composition, alignment, correction and restoration of fields due to their particles are the objective of this chapter. We define as correction of a field X , to a re-composition or alignment of X . Is re-composition if is a re-structure or re-definition of X , is to say, it is realize changes of their alignment and transition states. The corrective action is an alignment only, if X , presents a deviation or deformation in one of their force lines or energy channels. A restoration is a re-establishment of the field, strengthening their force lines.

If we consider to the trajectory Γ_j , in terms of their deviation $\theta x(s)$, of the classic path $x_c(s)$, of their harmonic oscillator of $L(x(s))$, we can establish that the harmonic oscillator propagator has total action accord with our quantum model of correction and restoration action of the path integrals studied in quantum mechanics, (Bulnes et al., 2010, 2011):

$$\mathfrak{Z}(x(s)) = \text{correction} + \text{restoration} = \mathfrak{Z}(\theta x(s)) + \mathfrak{Z}(x_c(s)) = \mathfrak{Z}(Id) + \int_{\Gamma} \mathfrak{Z}(x(s))\mu_s, \quad (4)$$

Observe that the term $\mathfrak{Z}(\theta x(t))$, corresponds to the actions that is realised using rotations. This term belongs to space $Hom_G(X(M), L(M)) = \alpha Id$, being Id , the identity and $\alpha \in \mathbb{R}$, (Bulnes, 2005), in the dual space of a restoration action of the field.

Now well, the relation between field and matter is realised through a quantum jump and only to this level succeeds. In the quantum mechanics, all the particles like pockets of energy works like points of transformation (states defined by energy densities). The field in the matter of a space-time of particles is evident like answer between these energy states, as it is explained in the *Feynman diagrams*. Due to that exist duality between wave and particle, a duality also exists between field and matter in the nature sense. Both dualities are isomorphic in the sense of interchange answers of interaction of a field. The answers between densities are realized in accordance with the correlation densities established in certain commutative diagrams that can be shaped by spaces L^2 , on the space-time of the particles (Oppenheim et al., 1983). Coding this region of transition states of the corresponding Feynman diagram on a logic algebra $\mathcal{A}(\cap, \cup, -)$ (like full states or empty of electrons like particle/wave, is to say, $\phi(0) = 0$, (is not the particle electron, but is like wave) $\phi(1) = 1$, (is not the wave electron, but is like particle) and their complements), where the given actions in (2), are applied and re-interpreting the region of the space-time of the particles like a electronic complex of a hypothetical logic nano- floodgate (is to say, like a space L^2 , with a logic given by $\mathcal{A}(\cap, \cup, -)$, on their transition states), we can define the *Feynman-Bulnes integrals*, as those that establish the transition amplitude of our systems of particles through of a binary code that realize the action of correction and restoration of the field established in (4). Likewise a Feynman-Bulnes integral (Bulnes, 2006c; Bulnes et al., 2010), is a *path integral of digital spectra* with the composition of the fast Fourier transform of densities of states of the corresponding Feynman diagrams. Thus, if ϕ_1, ϕ_2, ϕ_3 and ϕ_4 , are four transitive states corresponding to a Feynman diagram of the field $X(M)$, then the path integral of Feynman-Bulnes is:

$$I = \int_{\phi^-}^{\phi^+} \phi_{n_1} F(n_1) \phi_{n_2} F(n_2) \phi_{n_3} F(n_3) \phi_{n_4} F(n_4) = 0001101001\dots, \tag{5}$$

The integrals of Feynman-Bulnes, establish the amplitude of transition to that the input of a system with signal $x(t)$, can be moved through a synergic action of electronic charges \mathfrak{I} , doing through pre-determined waves functions by $L(x(t))$, and encoded in a binary algebra (pre-defined by states $\phi(0)$, and $\phi(1)$), (in the *kernel* the space of solutions of the wave equation $\partial_X \Delta_F^{AA'} = \nabla^{AA'} \delta(x - x')$, (Bulnes & Shapiro, 2007) of a point to other into a circuit Γ_j . Their integral is extended to all space of paths or re-walked included into the region of

Lagrangian action $\Gamma (= \bigcup_j^k \left(\bigcap_j^k \Gamma_j \right))$, with a topology of signals in $L^2(\cap, \cup, \setminus)$ (Bulnes et al.,

2011). If we want corrective actions for stretch Γ_j , of a path Γ , we can realize them using diagrams of strings of corrective action using the direct codification of path integrals with states of emission-reception of electrons (*by means of one symbolic cohomology of strings*) (Bulnes et al., 2011). Then the evaluation of the Feynman-Bulnes integrals reduces to the evaluation of the integrals: $I(\Gamma, \Omega) = \int_{C_r^0(\Psi)} \omega(\Gamma)$, where Ω , is the orientation of $C_r^0(\Psi)$, Ψ , is

the corresponding model of graph used to correct after identifying the singularity of the field X , that distorts it. For example, observe that it can vanish the corrective action of erroneous encoding through a sub-graph: $\int_{\Gamma_0} \omega(\Gamma) = 1 \cup -1 \cup 0 \cup [\phi(0) \cup 0 \setminus \phi(1)] \cup 1 = 0 \setminus \phi(1) \cup 1 = -1 \cup 1 = 1 + (-1) = 0$. The corresponding equation in the cohomology of strings is (Watanabe, 2007; Bulnes et al., 2011):

$$\tag{6}$$

The total correction of a field requires the action to a deep level as the established in (2), and developing in (4), and only this action can be defined by a logic that organises and correlates all and each one of the movements of the particles $x(s)$, *through codes given by (5), in a beautiful symphony that orders the field*. Finally we give an application to medicine obtaining the cure and organic regeneration to nano-metric level by quantum medicine methods programming our Path Integrals. Also, we give some applications to nano-materials.

2. The classic and non-classic Feynman integrals and their fundamental properties. The synergic and holistic principles

We consider a space of quantum particles under a regime of permanent energy defined by an operator of conservation called the Lagrangian, which establishes a field action on any trajectory of constant type. A particle has energy of interrelation defined by their energy density which relates the states of energy of the particle over to along of time considering the path or trajectory that joins both states in the space - time of their trajectories. Thus an infinite number of possible paths exist in the space - time that can take the particle to define their transition or impermanence in the space - time, the above mentioned due to the constant action of the field in all the possible trajectories of their space - time. In fact, the

particle transits in simultaneous form all the possible trajectories that define their movement. Likewise, if $\Omega(\Gamma) \subset \mathbb{R}^3 \times I_t$, is the set of these trajectories subject to a field X , whose action \mathfrak{S}_Γ , satisfies for any of their trajectories that $\delta(\mathfrak{S}_\Gamma) = 0$, then their Lagrangian L , acts in such a form that the particle minimizes their movement energy for any trajectory that takes in the space $\Omega(\Gamma)$, doing it in a combined effect of all the possible trajectories to go from one point to another considering a statistical weight calculated on the base of the statistical mechanics. This is the exposition of Feynman known as exposition of the added trajectories (Feynman, 1967). Come to this point, the classic conception of the movement of a particle question: How can a particle continue different trajectories simultaneously and make an infinite number of them?

In the quantum conception the perspective different from the movement of a particle in the space - time answers the previous question enunciating:

“The trajectory of movement of a particle is this that does not manage to be annulled in the combined effect of all the possible trajectories to go from one point to on other in the space - time”

2.1 Classic Feynman integrals and their properties

We consider $M \cong \mathbb{R}^3 \times I_t$, the space - time of certain particles $x(s)$, in movement, and be L , an operator that expresses certain law of movement that governs the movement of the set of particles in M , in such a way that the energy conservation law is applied for the entire action of each of his particles. The movement of all the particles of the space M , comes given geometrically by their tangent vector bundle TM . Then the action due to L , on M , comes defined as (Marsden et al., 1983):

$$\mathfrak{S}_L : TM \rightarrow \mathbb{R}, \tag{7}$$

with rule of correspondence

$$\mathfrak{S}(x(s)) = FluxL(x(s))x(s), \tag{8}$$

and whose energy due to the movement is

$$E = \mathfrak{S} - L, \tag{9}$$

But this energy is due to their Lagrangian L , defined as (Sokolnikoff, 1964)

$$L(x(s), \dot{x}(s), s) = T(x(s), \dot{x}(s), s) - V(x(s), \dot{x}(s), s), \tag{10}$$

If we want to calculate the action defined in (7) and (8), along a given path $\Gamma = x(s)$, we have that the action is

$$\mathfrak{S}_\Gamma = \int_\Gamma L(x(s), \dot{x}(s), s) ds, \tag{11}$$

For a classic trajectory, it is observed that the action is an extreme (minimum), namely,

$$\delta(\mathfrak{S}_\Gamma) = \delta \left(\int_{s(p_0)}^{s(p_1)} L(x(s), \dot{x}(s), s) ds \right) = 0, \tag{12}$$

Thus there are obtained the famous equations of Euler-Lagrange equivalent to the movement equations of Newton,

$$\left\{ \frac{d}{dt} \left(\frac{\partial L}{\partial \dot{x}} \right) - \frac{\partial L}{\partial x} \right\}_{\Gamma_{classic}} = 0, \quad s_0 \leq s \leq s_f, \quad (13)$$

That is to say, we have obtained a differential equation of the second order in the time for the freedom grade $x(s)$. This generalizes for a system of N grades of freedom or particles, with N , equations eventually connected. An alternative to solve a system of differential equations as the described one is to reduce their order across the formulation of Hamilton-Jacobi that thinks about how to solve the equivalent problem of $2N$ equations of the first order in the time (Marsden et al., 1983). Identifying the momentum as

$$p_i = \frac{\partial L}{\partial \dot{x}}, \quad (14)$$

we define the Hamiltonian or energy operator to the i th-momentum p_i , as:

$$\mathcal{H} = \sum_i^n p_i \dot{x}_i - L, \quad (15)$$

and Hamilton's equations are obtained

$$\dot{p}_i = \frac{\partial \mathcal{H}}{\partial x_i}, \quad \dot{x}_i = \frac{\partial \mathcal{H}}{\partial p_i}, \quad (16)$$

Nevertheless, it is not there clear justification of this extreme principle that happens in the classic systems, since any of the infinite trajectories that fulfill the minimal variation principle, the particle can transit, investing the same energy. Nevertheless the Feynman exposition establishes that it is possible to determine the specific trajectory that the particle has elected as the most propitious for their movement to go from $s(p_0)$, to $s(p_1)$, in the space-time being this one the one that is not annulled in the combined effect of all. Thus the quantum mechanics justifies the extreme principle affirming that the trajectory of movement of a particle is the product of the minimal action of a field that involves to the whole space- time where infinite minimal trajectories, that is to say, exist where the extreme condition exists, but that statistically is the most real. Likewise, the nature saves energy in their design of the movement, since the above mentioned trajectory belongs to an infinite set of minimal trajectories that fulfill the principle of minimal action established in (12).

The concrete Feynman proposal is that the trajectory or real path of movement continued by a particle to go from one point to another in the space-time is the amplitude of interference of all the possible paths that fulfill the condition of extreme happened in (12) (to see figure 1 a)). Now then, this proposal is based on the probability amplitude that comes from a sum of all the possible actions due to the infinite possible trajectories that set off initially in x_0 , to end then in x_f .

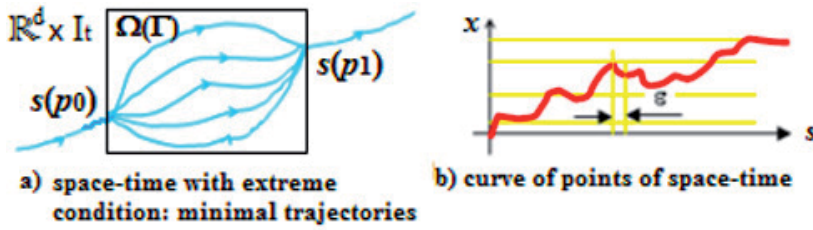

Fig. 1. a). The extreme condition in paths of the space $\Omega(\Gamma)$. b). Curve of the space-time in the $\mathbb{R}^3 \times I_t$.

Using the duality principle of the quantum mechanics we find that the particle as wave satisfies for this superposition

$$\psi(x, s) = A(s) \sum_{\gamma} \exp\left(\frac{i\mathfrak{S}}{\hbar}\right), \tag{17}$$

where the term $A(s)$, comes from the standardization condition in functional analysis (Simon & Reed 1980)

$$\int_{-\infty}^{+\infty} |\psi(x, t)|^2 dx = 1, \tag{18}$$

where to two arbitrary points in the space-time (s_0, x_0) , and (s_f, x_f) , whose amplitude takes the form $A' = \sqrt{\frac{m}{2\pi i \hbar (s_f - s_0)}}$. In effect, we approximate the probability amplitude taking only the classic trajectory. Of this way a Green function is had (propagator of x_0, s_0 to x_f, s_f) of the form:

$$D_F(x_f, s_f; x_0, s_0) = A' \exp\left(\frac{i\mathfrak{S}_{cl}}{\hbar}\right), \tag{19}$$

Then we consider to this classic trajectory:

$$x(s) = x_0 \frac{x_f - x_0}{s_f - s_0} (s - s_0), \tag{20}$$

$$v(s) = \frac{x_f - x_0}{s_f - s_0}, \tag{21}$$

Of this manner, the action on this covered comes given for

$$\mathfrak{S}_{clásica} = \int_{s_0}^{s_f} L(s) ds = \frac{m (x_f - x_0)^2}{2 (s_f - s_0)}, \tag{22}$$

It reduces us to calculate then the standardization term A' , for it we must bear in mind the following limit that in our case happens in the probability amplitude for $s_f \rightarrow s_0$:

$$\delta(x_f - x_0) = \lim_{\Delta \rightarrow 0} \frac{1}{(\pi\Delta^2)^{1/2}} \exp\left[-\frac{(x - x_0)^2}{\Delta^2}\right], \tag{23}$$

Identifying then to term of normalization like $A' = \Delta$, in (23) and using (22) it is had:

$$A' = \left(\frac{m}{2\pi i\hbar(s_f - s_0)}\right)^{1/2}, \tag{24}$$

Therefore, the exact expression is had in the probability amplitude

$$D_F(x_f, s_f; x_0, s_0) = \left(\frac{m}{2\pi i\hbar(s_f - s_0)}\right)^{1/2} \exp\left(i\frac{m}{2\hbar} \frac{(x_f - x_0)^2}{s - s_0}\right), \tag{25}$$

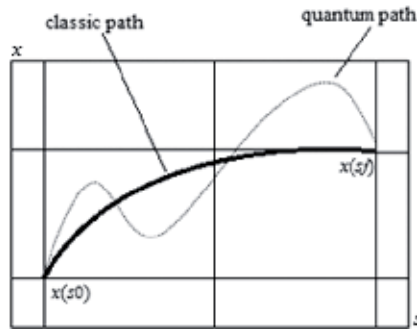

Fig. 2. Trajectories in the space-time plane, the continuous line corresponds to a classic trajectory while the pointed line corresponds to a possible quantum trajectory.

This type of exact results from the Feynman expression can also be obtained for potentials of the form:

$$V(x, \dot{x}, s) = a + bx + cx^2 + d\dot{x} + e\dot{x}\dot{x}, \tag{26}$$

But the condition given in (12), establishes that the paths that minimize the action are those who fulfill with the sum of paths given in terms of a functional integral, that is to say, those paths on the space $\Omega(\Gamma) \subset \mathbb{R}^3 \times I_t$, to know:

$$\sum_{\gamma} \exp\left(\frac{i\mathfrak{I}}{\hbar}\right) \longrightarrow \int_{\Omega(\Gamma)} \exp[i\mathfrak{I}_{x(s)}/\hbar] d(x(s)) = \int_{\Omega} \omega(\Gamma), \tag{27}$$

An interesting option that we can bear in mind here is to discrete the time (figure 2). Thus if the number of temporary intervals from s_0 to s_f is N , then the temporary increase is $\delta s = (s_f - s_0)/N$, which implies that $s_n = s_0 + n\delta s$. We express for x_n to the coordinate x , to the time s_n , that is to say $x_n = x(s_n)$. Then for the case of a free particle, it had that the action is given like:

$$\mathfrak{I} = \int_{s_0}^{s_f} L(s) ds = \frac{m}{2} \dot{x}^2, \tag{28}$$

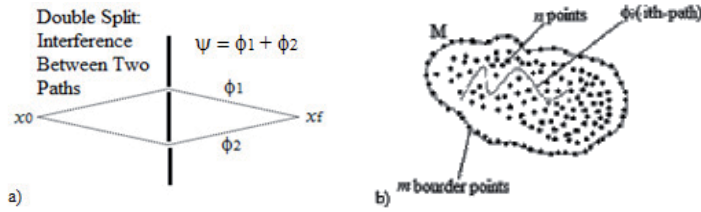

Fig. 3. a) Possible trajectories in an experiment of double split. The final amplitude result of the interference in between paths. b) The configuration space $C_{n,m}$, is the model created by the due action to each corresponding trajectory to the different splits. It is clear here that it must be had in mind all the paths in the space-time M , that contributes to the interference amplitude in this space.

Thus, on a possible path γ , it is had:

$$\mathfrak{I}_\gamma = \sum_{n=0}^{N-1} \frac{m}{2} \left(\frac{x_{n+1} - x_n}{\delta s} \right)^2 \delta s, \tag{29}$$

Thus it is observed that the propagator D_F , will be given for:

$$D_F(x_f, s_N, x_0, s_0) = \lim_{\substack{N \rightarrow \infty \\ \delta s \rightarrow 0}} A \int_{-\infty}^{+\infty} dx_1 \cdots \int_{-\infty}^{+\infty} dx_{N-1} \exp \left[\frac{im}{2\hbar} \sum_{n=0}^{N-1} \frac{(x_{n+1} - x_n)^2}{\delta s} \right], \tag{30}$$

Realizing the change $y_n = \left[\frac{m}{2\hbar\delta s} \right]^2 x_n$, we re-write:

$$D_F = \lim_{\substack{N \rightarrow \infty \\ \delta s \rightarrow 0}} A^N \int_{-\infty}^{+\infty} dy_1 \cdots \int_{-\infty}^{+\infty} dy_{N-1} \exp \left[- \sum_{n=0}^{N-1} \frac{(y_{n+1} - y_n)^2}{i} \right], \tag{31}$$

where $y_n = \left[\frac{2\hbar\delta s}{m} \right]^{(N-1)/2} A$. Developing the first integral of (31), we have

$$\int_{-\infty}^{+\infty} dy_1 \exp \left[- \frac{(y_2 - y_1)^2 - (y_1 - y_0)^2}{i} \right] = \left(\frac{i\pi}{2} \right)^{1/2} \exp \left[- \frac{(y_2 - y_0)^2}{2i} \right], \tag{32}$$

Then integrating for y_2 , we consider the second member of (32) and the following one, $(y^3 - y^2)^2$:

$$\left(\frac{i\pi}{2} \right)^{1/2} \int_{-\infty}^{+\infty} dy_2 \exp \left[- \frac{(y_3 - y_2)^2}{i} \right] \exp \left[- \frac{(y_2 - y_0)^2}{2i} \right] = \left(\frac{i\pi^2}{3} \right)^{1/2} \exp \left[- \frac{(y_3 - y_0)^2}{3i} \right], \tag{33}$$

Then a recurrence has in the integrals of such form that we can express the general term as $\frac{(i\pi)^{(N-1)/2}}{N^{1/2}} \exp \left[- \frac{(y_N - y_0)^2}{Ni} \right]$. Therefore it is had for the propagator (30), which

$$D_F(x_N, s_N, x_0, s_0) = A \left(\frac{2\pi\hbar i \delta s}{m} \right)^{(N-1)/2} \exp \left[\frac{m(x_N - x_0)^2}{2\hbar N \delta s} \right], \tag{34}$$

identifying in this case:

$$A = \frac{1}{B} = \left[\frac{2\pi\hbar i \delta s}{m} \right]^{-1/2}, \tag{35}$$

it is had that the integration in paths is given for:

$$\int_{\Omega(\Gamma)} \omega(x(s)) = \lim_{N \rightarrow \infty} \frac{1}{B} \int_{-\infty}^{+\infty} \frac{dx_1}{B} \dots \int_{-\infty}^{+\infty} \frac{dx_{N-1}}{B}, \tag{36}$$

$\delta s \rightarrow 0$

where in the first member of (36) we have expressed the Feynman integral using the form of volume $\omega(x(s))$, of the space of all the paths that join in $\Omega(\Gamma)$, to obtain the real path of the particle (therefore we can choose also quantized trajectories (see figure 2)). Remember that the sum of all these paths is the interference amplitude between paths that happens under an action whose Lagrangian is $\omega(x(s)) = \mathfrak{I}_{x(s)} dx(s)$, where, if $\Omega(M)$, is a complex with M , the space-time, and $C(M)$, is a complex or configuration space on M , (*interfered paths in the experiment given by multiple split (see the figure 3, to case of double split)*), endowed with a pairing

$$\int : C(M) \times \Omega^*(M) \rightarrow \mathbb{R}, \tag{37}$$

where $\Omega^*(M)$, is some dual complex (“forms on configuration spaces”), that is to say. such that “Stokes theorem” holds:

$$\int \omega = \langle \mathfrak{I}, d\omega \rangle, \tag{38}$$

$\Omega \times C$

then the integrals given by (36) we can be write (to m -border points and n -inner points (see figure 3 b)) as:

$$\int_{\Omega(\Gamma)} \mathfrak{I}(x(s)) dx(s) = \int_{\Gamma_1 \times \dots \times \Gamma_m \times \dots} \mathfrak{I}_q dx_1^{m_1} \dots dx_n^{m_n} = \int_{\Gamma_1} \left(\int_{\Gamma_2 \dots} \left(\int_{\Gamma_m} \mathfrak{I} dx_1^{m_1} \right) \dots dx_n^{m_n} \right), \tag{39}$$

This is due to the infiltration in the space-time by the direct action \mathfrak{I} , that happens in the space $\Omega \times C$, to each component of the space $\Omega(\Gamma)$, through the expressed Lagrangian in this case by ω . In (39), the integration of the space realises with the infiltration of the time.

Two versions of (36), that use the evolution operator and their unitarity are their differential version and numerical version of Trotter-Suzuki¹ (numerical version of (36)). The first version is re-obtain the Schrödinger equation from the Feynman path integral. In this case the wave function involves the corresponding electronic propagator given in (30) with a temporal step δs , to pass from $\psi(x, 0)$, to $\psi(x, \delta s)$, having the amplitude (Holstein, 1991)

¹ $D_F(s, s_0) = \theta(s - s_0) \lim_{N \rightarrow \infty} \int_{-\infty}^{+\infty} dx_1 \dots \int_{-\infty}^{+\infty} dx_{N-1} \prod_{j=0}^{N-1} \left\langle x_{j+1} \left| e^{\frac{-i\Delta T}{N}} e^{\frac{-i\Delta V}{N}} \right| x_j \right\rangle$.

Here, T , and V , are kinetic and potential energies in discrete form using their separate evolutions in slices. $\theta(s - s_0)$, is the weight of compenstation in numerical compute.

$$\psi(x, \delta s) = \left[\frac{m}{2\pi i \hbar \delta s} \right] \int_{-\infty}^{+\infty} \exp \left[i \frac{m \delta x^2}{2 \hbar \delta s} \right] \left[1 - i \frac{\delta s}{\hbar} V(x, 0) + \delta x \frac{\partial}{\partial x} + \frac{\delta s^2}{2} \frac{\partial^2}{\partial x^2} \right] \psi(x, 0) d\delta x, \quad (40)$$

Realising the integral we obtain the differential version of the Feynman integral (36). Let H , be the Hopf algebra (associative algebra used to the quantized action in the space-time) (Kac, 1990), of a class of Feynman graphs \mathcal{G} (Barry, 2005). If Γ , is such a graph, then configurations are attached to its vertices, while momentum are attached to edges in the two dual representations (Feynman rules in position and momentum spaces). This duality is represented by a pairing between a “configuration functor” (typically C_Γ , (configuration space of subgraphs and strings (Watanabe, 2007), and a “Lagrangian” (e.g. ω , determined by its value on an edge, e.g. by a propagator D_F). Together with the pairing (typically integration) representing the action, they are thought as part of the Feynman model of the state space of a quantum system.

Since it has been argued in (Ionescu, 2004), this *Feynman picture* is more general than the manifold based “Riemannian picture”, since it models in a more direct way the observable aspects of quantum phenomena (“interactions” modeled by a class of graphs), without the assumption of a continuity (or even the existence) of the interaction or propagation process in an ambient “space-time”, the later being clearly only an artificial model useful to relate with the classical physics, i.e. convenient for “quantization purposes”.

Likewise, an action on \mathcal{G} (“ \mathfrak{S}_{int} ”), is a character $\mathfrak{S}_{int} : H \rightarrow \mathbb{R}$, (defined similarly to the given in (7)) which is a cocycle in the associated $D\mathcal{G}$ -co-algebra $(T(H^*), D)$, that is to say, the action in this context is an endomorphism (matrix) of transition of the certain densities of field given by ϕ .

A QFT (*Quantum Field Theory*) defined via Feynman Path Integral quantization method is based on a graded class of Feynman graphs. For specific implementation purposes these can be 1-dimensional CW-complexes or combinatorial objects. For definiteness we will consider the class of Kontsevich graphs $\Gamma \in \mathcal{G}_n$, the admissible graphs from (Kontsevich, 2003). Nevertheless we claim that the results are much more general, and suited for a generalisation suited for an axiomatic approach; a Feynman graph will be thought of both as an object in a category of Feynman graphs (categorical point of view), as well as a *co-bordism* between their boundary vertices (TQFT point of view). The main assumption the class of Feynman graphs needs to satisfy the existence of subgraphs and quotients.

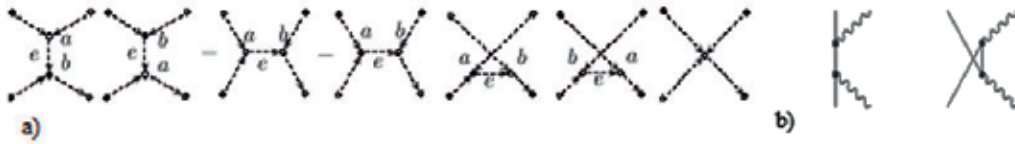

Fig. 4. The Kontsevich class is the quantized class used by the Feynman rules.

Example 1. In the compute of path integrals on the graph configuration space $C_\square(\Omega)$, The graphs $\Gamma \in \mathcal{G}_n$, will be used in the string schemes given by BRST-quantization on gauge theory. For example, the BRST-quantization is always nilpotent around a vertex: $Q_{BRST} \bullet v = \oint dz j_{BRST}(z) v(0) = 0$. The Kontsevich class not has loops everywhere (figure 4 a)). The Feynman diagrams (figure 4 b)) conforms a subclass in the Kontsevich class, that is

to say, restricted in the deformation quantization in respective micro-local structure of the Riemannian manifold (Kontsevich, 2003).

While the concept of subgraph of γ , is clear (will be modeled after that of a subcategory), we will define the quotient of Γ , by the subgraph γ as the graph Γ/γ , obtained by collapsing γ , (vertices and internal edges) to a vertex of the quotient. Then it satisfies the graph class succession under *Hom*, that will define all the types of graphs with connecting arrows:

$$\gamma \rightarrow \Gamma \rightarrow \Gamma/\gamma, \tag{41}$$

We enunciate the following basic properties of the classic Feynman integrals. Let $\gamma, \gamma' \in \Gamma$, where $\Gamma \in \mathcal{G}$, and $\omega(\Gamma)$, their corresponding Lagrangian with the property like in (38). We consider the path integral I_Γ , like a map given in (37). Let D_F , their corresponding propagator (the value of $\omega(\Gamma)$, in the corresponding edge γ). Then are valid the following properties:

- a. $\forall D_F$, propagator there is an unique extension to a Feynman rule on (39), that is to say $\omega(\Gamma) = \omega(\gamma) \wedge \omega(\gamma')$, with $\Gamma/\gamma = \gamma'$.
- b. If $\omega(\Gamma)$, is a Lagrangian on (41) with $\Gamma/\gamma = \gamma'$, then

$$\int \omega(\Gamma) = \int \omega(\gamma) \wedge \omega(\gamma'), \tag{42}$$

- c. From (38) $\int_{\partial C} \omega = \mathfrak{Z} \circ D_F$, then \forall extension (41),

$$\int_{\partial \gamma \mathfrak{Z}(\Gamma)} \omega(\Gamma) = \mathfrak{Z}(\gamma) \bullet \mathfrak{Z}(\gamma'), \tag{43}$$

- d. $\forall \Gamma \in \mathcal{G}$ (Feynman graph),

$$\sum_{e \in I_{\text{int}}} \int_{\partial e \bar{C}_\Gamma} \omega(\Gamma) \mathfrak{Z}(d^{\text{int}} \Gamma), \tag{44}$$

where e , is a simple sub-graph of Γ , without boundary.

- e. As consequence of the integral (44), we have the composition formulas

$$\mathfrak{Z} \circ D_{F_e} = \mathfrak{Z} \circ d^{\text{int}}, \quad \mathfrak{Z} \circ D_{F_{(i-e)}}, \tag{45}$$

- f. Feynman integrals over codimension one strata corresponding to non-normal subgraphs vanish. A graph $\Gamma \in \mathcal{G}$, is normal if the corresponding quotient Γ/γ , belongs to the same class of Feynman graphs \mathcal{G} .
- g. The remaining terms corresponding to normal proper subgraphs meeting the boundary $[m]$, of $\Gamma \in \mathcal{G}_a$, yield a forest formula, like intM (figure 3, b)) corresponding to the co-product D_{F_b} , of \mathcal{G} . Then for a Feynman graph $\Gamma \in \mathcal{G}_a$:

$$\sum_{\gamma \rightarrow \Gamma \rightarrow \Gamma/\gamma \in \mathcal{G}} \int_{\partial_\gamma \bar{C}_\Gamma} \omega(\Gamma) \mathfrak{Z}(D_{F_b}, \Gamma), \tag{46}$$

where the proper normal subgraph γ , meets non-trivially the boundary of Γ .

- h. If the Lagrangian $\omega(\Gamma)$, is a closed form then the corresponding Feynman integral \mathfrak{Z} , is a cocycle. Then

$$\int_{\partial \tilde{C}_r} \omega(\Gamma) = \int_{\tilde{C}_r} d\omega(\Gamma) = 0, \tag{47}$$

2.2 Non-classic Feynman integrals and their properties

2.2.1 Twistor version (Bulnes & Shapiro, 2007)

Consider the space of hypercomplex coordinates (coordinates in the m -dimensional complex projective space \mathbb{P}^m) that determine through the position, quantum states of particles in free state $Z_1^a, Z_2^a, \dots, Z_m^a$, and we define the functional space of Feynman

$$\Phi_D = \{ F_U \mid F_U(z) = \int d^n z \phi_1(z) \phi_2(z) \dots \phi_n(z) = 000 \dots 0\text{-box diagram} \}, \tag{48}$$

This space is the corresponding to the group of Feynman ϕ^n -integral for the 000 ... 0-box diagram (that is to say, $C(M)$ given in the before section) with certain configuration space $C_{n, m}$, like was defined in section 1. 2, (with n -states ϕ_i , and m -edges or lines) with arrange

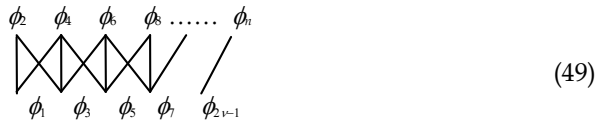

This functional belongs to the integral operator cohomology on homogeneous bundles of lines $H^1(\mathbb{P}\mathcal{T}, O(-2-2))$, where $\mathbb{P}\mathcal{T} = \mathbb{P}\mathcal{T}^+ \cup \mathbb{P}\mathcal{T}^-$ for example, for $n = 4$, one has the diagram of Feynman for the ϕ^4 -integral one that corresponds to the 0000-box diagram



The elements F_U , can be expressed in a low unique way the map in the complex manifold \mathbb{P}^m , like

$$\Phi_D \rightarrow \mathcal{L}(\mathbb{P}^m(\mathbb{C}), \mathbb{C}), \tag{51}$$

with rule of correspondence

$$\int d^n z \phi_1(z) \phi_2(z) \dots \phi_n(z) \mapsto \int d^n Z^\alpha W_\alpha \phi_1(Z^\alpha W_\alpha) \phi_2(Z^\alpha W_\alpha) \dots \phi_n(Z^\alpha W_\alpha), \tag{52}$$

that allows us to identify Φ_D , with $\mathcal{L}(\mathbb{P}^m(X), X)$. Building the twistor space $\mathcal{T} = \{ [x]_U \mid [x]_U = \dots + (x)_{-2} + (x)_{-1} + (x)_0 + (x)_1 + \dots \}$, where $(x)_{-n} = (x)^{-n}/n!$ (contours with opposite $x = 0$) and $(x)_{n+1} = -n!(x)^{n-1}/2\pi i$ (in an environment around $x = 0$). This twistor space satisfies that $\mathcal{T} \cong \mathcal{L}(\mathbb{P}^m(\mathbb{C}), \mathbb{C})$. Then $\int d^n z \phi_1(z) \phi_2(z) \dots \phi_n(z) = \oint [x]_U \forall x \in \mathbb{C}^m$. Then these integrals have their equivalent ones as integral of contour in the cohomology of contours $H^d(\Pi - \Upsilon, \mathbb{C})$, where Π , it is the product of all the twistor spaces (and dual twistor) and it is the subspaces union

on those which the factor $(Z^a W_a)^{-1}$, are singular. To check this course with demonstrating, for the case $m = 1$, and using the integral operator of Cauchy has more than enough contours (jointly with the residue theorem) that the integral $\int d^n z \phi_1(z) \phi_2(z) \dots \phi_n(z)$ takes the form of the formalism of Sparling given by the integral one

$$\oint[x]_{\mathbb{U}} = \left\{ \oint_0^{\infty} + \int \right\} \frac{e^z}{(x+z)} dz, \tag{53}$$

which bears to the isomorphism among the cohomological spaces

$$H^1(\mathbb{P}(\mathbb{C}), \Omega) \cong H^1(\mathbb{P}\mathcal{T}, O(-2-2)), \tag{54}$$

which would be a quaternion version of these integrals? It would be the one given for integral of type Cauchy of functions of \mathbb{H} -modules (Shapiro & Kravchenko, 1996), on opened D , that turn out to be Liapunov domains in \mathbb{R}^n . Since one has the you make twistor projective bundle $S^2 \setminus \mathbb{P}^3(\mathbb{C}) \rightarrow \mathbb{P}(\mathbb{H}) \cong S^4$, and $H^1(\mathbb{P}\mathcal{T}, O(-2-2)) \cong H^1(\mathbb{P}(\mathbb{C}), \Omega)$, then the cohomology $H^1(\mathbb{P}(\mathbb{C}), \Omega) \cong H^1(\mathbb{P}(\mathbb{C}), \text{space in corresponding differential forms})$. But $S^1 \rightarrow \mathbb{P}^3(\mathbb{C}) \rightarrow \mathbb{P}(\mathbb{C})$, it is a principal bundle with $\mathbb{P}(\mathbb{C}) \rightarrow S^2$, and since S^1 , and S^3 , are the underlying groups in the structure of the hyper-complexes and quaternion ($\mathbb{H} \cong \mathbb{C}^2$) then $S^1 \rightarrow S^3 \rightarrow S^2$, represents in quantum mechanics a spin system $\frac{1}{2}$ which can be represented by the cohomology of a diagram formed as an alternating chain of 0-lines and 2-lines, that is; $H^1(\mathbb{P}\mathcal{T}^{\pm}, O(-n-2))$, that is to say for the system of quantum state of spin $\frac{1}{2}$ that is the corresponding to a 4-integral one given by the 0000-box diagram

$$= \iint d^4x d^4y \phi(x) \psi_A(x) S_x D_{F^{AA'}}(x-y) \psi_{A'}(y) \theta(y), \tag{55}$$

But this cohomology of diagrams of contour integrals is applicable to 1-functions for $\mathbb{P}(\mathbb{C})$, in $\mathbb{P}\mathcal{T}^{\pm}$, that which is not chance, since it is a consequence of the G -structure of the manifold \mathbb{F} , (where they are defined these quantum phenomena) which is induced in the S^3 -structure of the underlying spinors (Penrose & Rindler, 1986).

If we consider that the for-according complex manifolds have a pseudo-Hermitian complex structure not symmetrical and induced by the sheaf of quadratic forms $\mathcal{O}(8^2 T^*(M))$, it can expand the symmetry according classic of the diagrams of Feynman from their contour integrals to the construction of according structures that can be induced to the pseudo-Hermitian complex structure of the mentioned manifolds, giving the possibility to obtain a single integral operators cohomology of Feynman type for analytic manifolds (Huggett, 1990).

2.2.2 Instanton version

The Feynman integrals are invariants in \mathbb{R}^3 , under rotations of Wick, that is to say

$$\int_{\Omega(\Gamma)} \exp[i\mathfrak{I}[\phi]]\mathcal{D}[\phi] \mapsto \int_{\Omega(\Gamma)} \exp[-\mathfrak{I}[\phi]]\mathcal{D}[\phi], \quad (56)$$

to a coordinates system in E^4 , given by (x_0, x_1, x_2, x_3) , with $x_0 = s$, then \forall coordinates transformation given by $s \rightarrow it$, we have that

$$M \rightarrow E^4, \quad (57)$$

then $\Omega(\Gamma)$, represents a region $W(C)$, in E^4 (a Wick region in the space time). This action has place in S^4 , to the solutions of the Yang-Mills equations on S^4 . The action realised in this transformation has Euclidean action

$$\mathfrak{I}_E = \int_{\tau_1}^{\tau_2} \left(\frac{1}{2} m \dot{x}(\tau)^2 + V(x) \right) d\tau, \quad (58)$$

where the potential energy $V(x)$, changes to $-V(x)$, with the Wick rotation.

2.2.3 Feynman-Bulnes version

Considers a microelectronic device that is fundamented in the functional space $L^2(\cup, \cap, /)$ encoding in a logic algebra $\mathcal{M}_{1,0}$. The corresponding functional equation to inputs and outputs of information signals using certain liberty based in the artificial process of thought to create "intelligent" computers needs the use of path to plantee their solution (Bulnes, 2006c). Then extrapolating the Feynman integrals to calculate the amplitud of interference of the many paths (criteria) to resolve a automation problem that designs a cybernetic complex that at least to theoretical level has a quantum programming with Feynman rules and an adequate neuronal net².

Def. 1 (Path Integrals of Feynman-Bulnes). A integral of Feynman-Bulnes is a path integral of digital spectra with composition with Fast Transform of densities of state of Feynman diagrams.

If ϕ_1, ϕ_2, ϕ_3 , and ϕ_4 , are four densities of states corresponding to the Feynman diagrams to the poles of field $X(M)$, then the path integral of Feynman-Bulnes is:

$$I_{FB} = \int_{Z^-}^{Z^+} \phi_{n_1} F(n_1) \phi_{n_2} F(n_2) \phi_{n_3} F(n_3) \phi_{n_4} F(n_4), \quad (59)$$

² The integrals of Feynman-Bulnes give solution to the functional equation of a automatic micro-device to control (micro-processor) $F(XZ^+, YZ^-) = 0$ (Bulnes, 2006c). The informatics theory assign a cybernetic complex to \mathbb{C} , (Gorbatov, 1986) and each cube in this cybernetic net establish a path on the which exist a vector of input XZ^+ , and a vector of output YZ^- , signed with a time of transition τ , to carry a information given in XZ^+ , on a curve γ_τ , (path) to a state YZ^- , through logic certain (conscience), that include all the circuit \mathbb{C} (Bulnes, 2006c). In the case of \mathbb{C} , the logic is the real conscience of interpretation of \mathbb{C} , (criteria of \mathbb{C}). As \mathbb{C} , has a real conscience of recognition; into of their corrective action and reexpert, elect the adequate path to the application of the corrective action. For it, the integrals of Feynman-Bulnes can be explained on the electable model Ψ_β , (path, see figure 1 a)) as:

$$\text{correcci\`on} = \int_{Z^-}^{Z^+} D_F(z(t)) \mu_{n_1} F(n_1) d(z(t)) = \sum_n^N \delta(\Psi_\alpha - \Psi_\beta) \phi(\Psi_\alpha).$$

3. Combination of quantum factors and programming diagrams of path integrals: The coding and encoding problems

Since a duality exists between wave and particle, a duality also exists between field and matter in the natural sense (Schwinger, 1998). Both dualities are isomorphic in the sense of the exchange of states of quantum particles and the interaction of a field. Indeed in this quantum exchange of information of the particles, that happen in the space-time $\Omega(\Gamma)$ region, the pertinent transformations are due to realise to correct, restore, align or re-compose (put together) a field X .

Elements of field	Nano-metric application	Effect obtained on field
0-lines	localization of anomalous points	encoding nodes to application
1-lines	application of electronic propagator	alignment of lines of field
-1-lines	inversion of actions*	reflections of restoration

* Creation of contours around of points of application

Table 1. Combination of quantum factors of the field X .

Any anomalous declaration in a quantum field shows like a distortion, deviation, non-definition or not existence of the field in the space-time where this must exist like physical declaration of the matter (existence of quantum particles in the space). The quantum particles are transition states of the material particles. We remember that from the point of mathematical view, a singularity of the space $X(M)$, is a discontinuity of the flux of energy, where $FluxD_{Fj}(z)z \neq 0, \forall z \in M$ (Marsden et al., 1983). This discontinuity creates a space of disconnection where the alignment atoms stay unenhanced due to not have electrons that they do unify them under the different chemical links that exist and through the ionic interchange foreseen in the space TM^{\pm} ,³(Landau & Lifshitz, 1987), (vector bundle of the particles in M , and responsible of the geometrical configuration of the field in M , and that promote the ionic restoration in $X(M)$, (*Gauge theory*). In a topological sense of the field, the detection of these anomalies of the field X will do through anomalies in the trajectories of flux $\gamma(z)$, such that $FluxD_{Fj}(z)z \neq 0, \forall z \in \gamma(z) \subset M$.

Def. 2. [10] If $Flux: \mathbb{R} \times M \rightarrow M$, is a flux and $z \in M$, the curve $\gamma_z: \mathbb{R} \rightarrow M$, with rule of correspondence $t \mapsto \phi_t(z) = \phi(t, z)$, is a line of flux.

A anomaly in a trajectory and thus in M , will be a singular point which can be a knot (multiform points), a discontinuity (a hole (source or fall hole) in M) or a indeterminate point (without information of the field in whose point or region in M). But we require their electromagnetic mean into the context of X , for we obtain their corresponding diagnosis using an electromagnetic device that establish an univocal correspondence between detected anomalies and Feynman diagrams used to the spectral encoding through of the integrals of Feynman-Bulnes.

If we consider the space $C^0_{\Gamma}(\psi)$ (Watanabe, 2007), as space of configuration associate with sub-graph (Γ, ψ) , where ψ , is the corresponding smooth embedding to n -knot that which is identified as a ∞ , in an integral as the given in (6), we can define rules to sub-graphs that coincides with the rules of signs in the calculate of integrals like (36). Thus we can identify the three fundamental forms given for $\omega(\Gamma) = \Pi sgn(z)$, (figure 5).

³ $X(M)$, is a section of TM^{\pm} , in a mathematical sense (Marsden et al., 1983).

In this study the path integrals and their applications in the re-composition, alignment, correction and restoration of fields due to their particles realise using certain rules of fundamental electronic state and their sub-graphs, through considering the identification. We define as correction of a field X , to a re-composition or alignment of X . Is re-composition if it is a re-structure or re-definition of X , is to say, it is realize changes of their alignment and transition states (properties of the table 1 and additional properties with the algebra $\mathcal{M}_{0,1}$). The corrective action is an alignment only, if X , present a deviation or deformation in one of their force lines or energy channels (properties of contours on particles: $\rightarrow \text{---} \text{---} \text{---} \rightarrow, \curvearrowright \rightarrow, \rightarrow \curvearrowright$). A restoration is a re-establishment of the field, strengthening their force lines (properties of the Dirac and Heaviside function on particles: with $t \geq s, w(s, t)\phi(-1) \leq \phi(1)U_0(s, t)$, etc) (Fujita, 1983). Consider the following corrective action by the string diagrams to the states of emission-receptor of electrons (see figure 5 a)). The evaluating of the integrals of Feynman-Bulnes is reduced to evaluating the integrals:

$I(\Gamma; \Omega) = \int_{C^0_\Gamma(\Psi)} \omega(\Gamma)$, where Ω , is the orientation on $C^0_\Gamma(\Psi)$, where Ψ , is the corresponding model of graph used to correct and identify the anomaly and Γ , the corresponding sub-graph of the transitive graph determined by a re-composition field treatment. The space $\mathcal{M}_{0,1}$, conforms a reticular sub-algebra in mathematical logic. In the figure 5 b), the corrective action in the memory of an Euclidean portion of the space time $\Omega(\Gamma)$, through a sub-graph Γ , of strings, in the re-composition of the alignment of field comes given as: $z_j = \int_{C^0_\Gamma(\Psi)} \theta_1 \theta_2 \theta_3 \theta_4 = \langle [1 \cup \phi(1)] \cup 0 \rangle \cup \phi(1) \rangle \cup 1 = 1$, (Bulnes, 2006c). Observe that it can vanish the corrective action of encoding memory through another sub-graph: $\int_{\Gamma_0} 1 \cup -1 \cup 0 \cup [\phi(0) \cup 0 \cup \phi(1)] \cup 1 = 0 \cup \phi(1) \cup 1 = -1 \cup 1 = 1 + (-1) = 0$ (see the equation (6)).

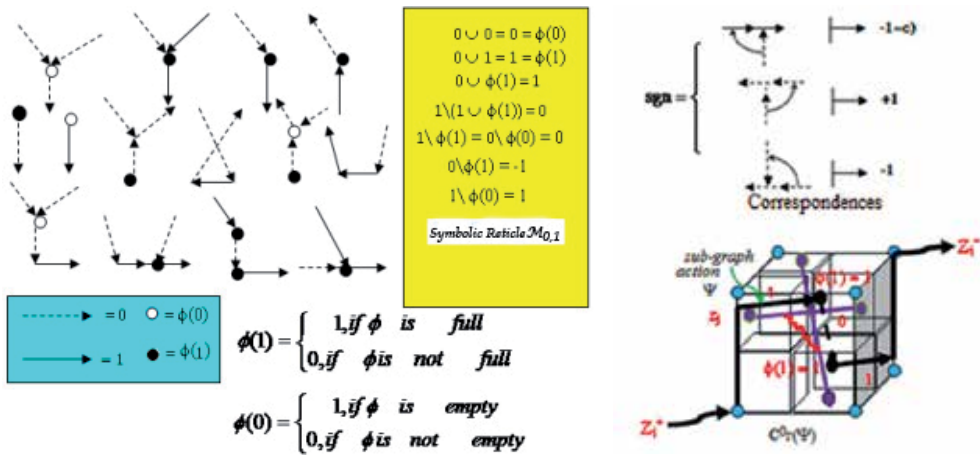

Fig. 5. a) String diagrams of corrective action using direct encoding by path integral. b) Euclidean portion of the space time $\Omega(\Gamma)$.

All anomalies in the space-time produce scattering effects that can be measured by the proper states using the following rules, considering these anomalies like a process of scattering risked by the particle with negative potential effect of energy:

	Particle $\phi(1)$	Anti-particle $\phi(-1)$
Input	$\phi(1) \bullet \longrightarrow \circ$ Positive future	$\phi(1) \bullet \longleftarrow \circ$ negative future
Output	$\phi(1) \circ \longrightarrow \bullet$ Positive past	$-\phi(1) \circ \longleftarrow \bullet$ negative past

Table 2. Past and future in the scattering effect of the field X.

The negative actions in one perturbation created by an anomaly in the quantum field X, acts deviating and decreasing the action of the “healthy” quantum energy states ϕ_i ($i = 1, 2, \dots$), in the re-composition of field (see the example explained in the figure 6).

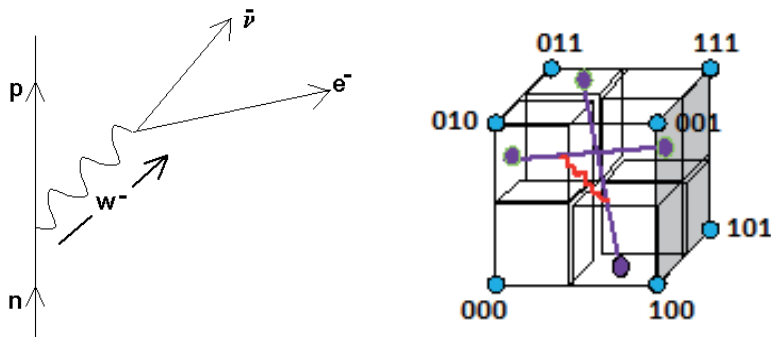

Fig. 6. a) Feynman diagram to a negative boson field. b) Cube of the net of the configuration space.

Example 2. The energy in this Feynman diagram is the given by $E_{\text{output}} = W^- = -E$, (negative boson in the field $\mathfrak{h}_{\mu\nu}$ (of interactions given in $SU(3)$) (Holstein, 1991). Then their path integral to output energy is: $I^{\alpha\beta} = \int_{C^0(\Gamma)} \phi = -1$ (see figure 6 a)). For other side, the cube of the net of the configuration space $C^0_\Gamma(\Psi)$ of the space-time $\Omega(\Gamma)$ is the 3-dimensional cube to arrangements in 000-box (see figure 6 b)).

4. On a fundamental theorem to correction and restoring of fields and their corollaries

One result that explains and generalises all actions of correction and restoring of a quantum field including the electromagnetic effects that observes with vector tomography is:

Theorem 1 (F. Bulnes) (Bulnes et al., 2010). Be $M = X(M) \setminus M$. Be a set of singular points of M , such that the states of $X(M)$, in these points are distorted states of the field X . An integral of line $I_{\alpha\beta} \in H^1(\mathbb{P}M^\pm; \mathcal{O}(-k))$, to k a helicity in M , determine an answer of the transformation $I_{\alpha\beta} X(M)$, that it is an appropriate width to correct the field $X(M)$, under the action of the operator $D_F(M)$, such that (10) is satisfied, then the integral of line that re-establishes the field and recomposes the part $X(M)$ comes given for

$$I^{\alpha\beta} = \int_{\gamma} \left[\iint_M D_F(x(s)) X(Z^\alpha, W_\alpha, X^\alpha, Y) \omega \right] \mu_s,$$

The effect on the field is re-construct and re-establish their lines of field (channels of energy) by synergic action (see figure 8).

Proof. (Bulnes, 2006a; Huggett, 1990).

The fundamental consequences are great, and they have to do with the reinterpretation of the anomalies of the field in an electromagnetic spectra (Schwinger, 1998), (see the figure 7), which we can measure across detectors of electromagnetic radiation, detectors and meters of current, voltage or amperage calibrated in micro or nano-units (Bulnes et al., 2011).

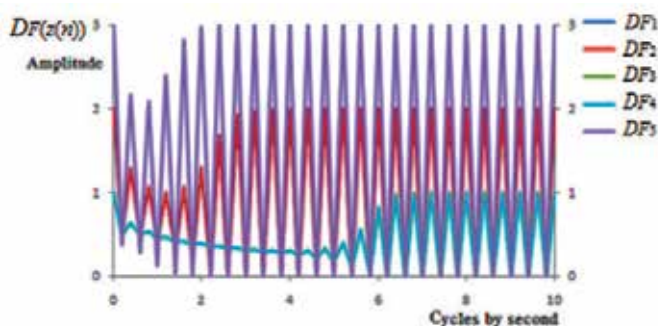

Fig. 7. Electronic propagators measuring corrective and restorer actions.

An important result (that can be a consequence in a sense of the previous one (for example in integral geometry and gauge theory)) that applies the vector tomography to electromagnetic fields used to measure fields of another nature and classify the anomalies by their electromagnetic resonance (at least in the first approach) is given by:

Theorem 2 (Bulnes, F) (Bulnes, 2006b). If the Radon transform (tomography on $X(M)$) is not defined, is infinite or has the value of zero, the corresponding pathologies are: great emission of electromagnetic radiation, current or voltage (points unless polarity *due to the atomic degradation (isotopes)*, have a node with variation not bounded of current, voltage or resistance (it is loose or is much (*ponds of energy*)) *due to an existence of positron states* (like the defined in table 2)), has a peak or is a node, due to that have not unique value or this is indeterminate (not have determined direction, can have a *source of increase scattering*).

Proof. (Bulnes, 2006a).

In the demonstration of the theorem 1, the Stokes theorem guarantees the invariance of the value of the integrals of path under the application of an electromagnetic field (Landau & Lifshitz, 1987), like gauge of a quantum field, since the value of these integrals does not depend on the contour measured for the detection of a field anomaly (Bulnes et al., 2011).

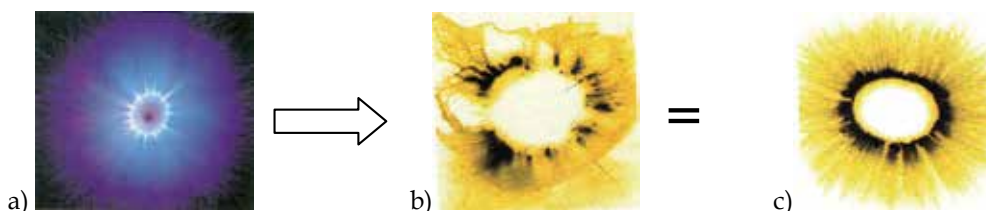

Fig. 8. The field in a) is the radiation electromagnetic spectra to re-compose and restore the field X , given in b). The corresponding image in c), is the field restored and corrected after the application a) in b).

5. Some applications to nano-medicine, nano-engineering and nano-materials

5.1 Application to nanomedicine

In nanomedicine the applications of the corrective actions and restorers of a field are essential and they are provided by the called integral medicine, which bases their methods on the regeneration of the codes of cellular energy across the conduits of energy of the vital field that keeps healthy the human body, the above mentioned for the duality principle of mind-body. But the transformations are realised in the quantum area of the mind of the body, that is to say the electronic memory of the healthy body. The mono-pharmacists of integral medicine contain codes of electronic memory at atomic level that return the information that the organs have lost for an atomic collateral damage.

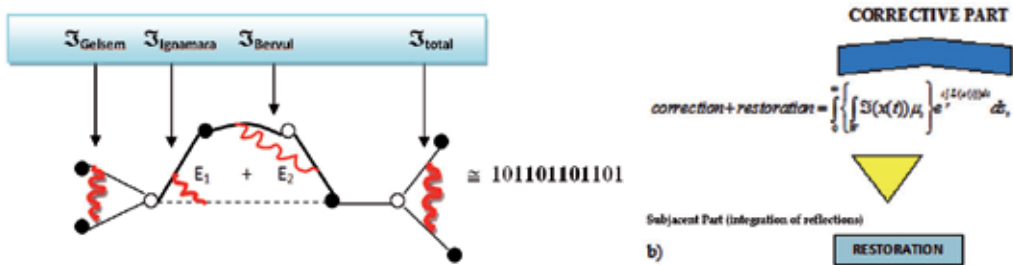

Fig. 9. Diagram of strings and path integrals of intelligence code of cure.

Diagram of strings belonging to the cohomology of strings equivalent to the code of electronic memory spilled to a patient sick with the duodenum (Bulnes et al., 2011) (see figure 9 a)). In nanomedicine, the path integrals are intelligence codes of corrective and restoration actions to cure all sicknesses. In the (see figure 9 b), W , is the topological group of the necessary reflections to the recognition of the object space of the cure (Bulnes et al., 2010). This recompose the amplitude of the wave defined in the spectra $I^{\alpha\beta}X(B)$, (with B , the human body) in the context of the space-time that to our nano-metric scale this space is constituted of pure energy. Into this space transits the geodesics or paths, to each particle where to each one of those paths exist a factor of weight given by $\exp(i\mathfrak{S}/\hbar)$, with \hbar , the constant of Max Planck and \mathfrak{S} , is the classical action associate to each path (see figure 8 b)).

5.2 Application to nanomaterials

The study of the resultant energy due to the meta-stables conditions that it is obtains in the quasi-relaxation phenomena establishes clearly their plastic nature for the suffered deformations on the specimen. Nevertheless their study can to require the evaluation of the field of plastic deformation on determined sections to a detailed study on the liberated energy in the produced dislocations when the field of plastic deformation acts. Thus, it is doing necessary the introduction of certain evaluations of the actions of the field to along of the dislocation trajectories in mono-crystals of the metals with properties of asymptotic relaxation. Then we consider like specimens, mono-crystals of *Molybdenum* (Mo), (see figure 10) subject to stress tensor that produce the plastic deformation given by the action inside of path integral

$$\int_M L\varepsilon(t)d(\varepsilon(t)) = \int_0^{+\infty} \left[\int_M d\varepsilon_{PT} \right] \varphi(\tau)e^{-\tau t} d\tau, \quad (60)$$

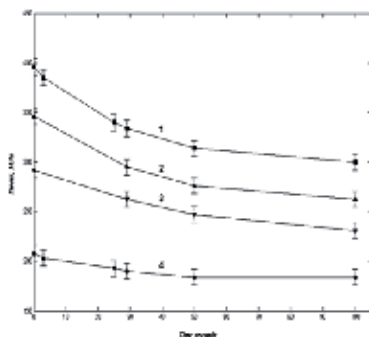

i)

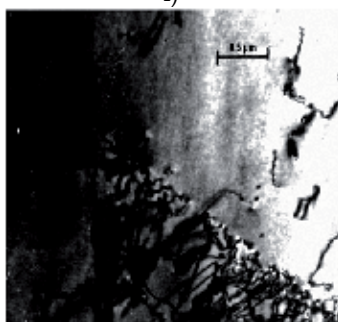

ii)

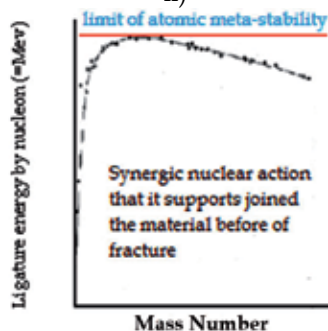

iii)

Fig. 10. i). Quasi-relaxation curves for Molybdenum single crystal: 1.- $\sigma_0 = 396$ MPa, 2.- $\sigma_0 = 346$ MPa, 3.- $\sigma_0 = 292$ MPa, 4.- $\sigma_0 = 208$ MPa. Mo $\langle 100 \rangle \{100\}$, at $T = 293$ °C. ii). Image of the electronic microscope of high voltage, HVTEM of Molybdenum single crystal in regime of quasi-relaxation. iii). Atomic meta-stability condition.

By the theorem of Bulnes-Yermishkin (Bulnes, 2008), all functional of stress-deformation to along of the time must satisfy for hereditary integrals in the quasi-relaxation phenomena that have considered the foreseen actions inside of trajectory of quasi-relaxation like path integrals measuring field actions on crystal particles of metals:

$$\Gamma(\sigma - \varepsilon, t) = \int_0^{+\infty} \left[\int_0^t \sigma(t) d\varepsilon(t) \right] \varphi(\tau) e^{-\tau t} d\tau, \quad (61)$$

The square bracket in (60), is the one differential form $\omega(\Gamma_\varepsilon)$, using the property (42), on the space-time $\Omega(\Gamma)$. The figure 10 iii), establish the behavior to atomic level in the tendency of the mono-crystals to be joined in meta-stability regime (Alonso & Finn, 1968).

5.3 Nanoengineering and nanosciences

Since it has been mentioned previously if we consider a set of particles in the space E , under certain law of movement defined by their Lagrangian L , we have that the action defined by a field that expires with this movement law and that causes it is defined by the map:

$$\mathfrak{S} : TE \rightarrow \mathbb{R},$$

with rule of correspondence as given in (8), we can establish that the global action in a particles system with instantaneous action can be re-interpreted locally as a permanent action of the field considering the synergy of the instantaneous temporary actions under this permanent action of the field. This passes to the following principle:

Principle. The temporary or instantaneous action on a global scale can be measured like a local permanent action.

The previous proposition together with certain laws of *synchronicity of events* in the space-time will shape one of the governing principles of the nanotechnology, why? Because at microscopic level the permanence of a field is constant in proportion to the permanence and the interminable state of energy that exists in the atoms. As a result of it a nanotechnological process will be directed to the manipulation of the microstructures of the components of the matter using this principle of "intentional" action. Then supposing that the field X , can control under finite actions like the described ones for \mathfrak{S} , and under the established principle, we can execute an action on a microstructure always and when the sum of the actions of all the particles is major than their algebraic sum (*to give an order to only one particle so that the others continue it*). How to obtain this combined effect of all the particles that move and that is wanted realise a coordinated action (of tidy effect) and simultaneously (synchronicity), with the only effect?

Inside the universe of minimal trajectories that satisfies the variation functional (12) we can choose a $\gamma_t \in \Omega(\Gamma)$, such that

$$\text{Exe} \mu_t = \int_{\gamma_t} \left(\int_{p_1}^{p_2} L(x(s)) d(x(s)) \right) \mu_{\gamma_t}, \quad (62)$$

which is not arbitrary, since we can define any action on γ_t , like

$$\mathfrak{S}_{\gamma_t} = \int_{p_1}^{p_2} L(x(s), \dot{x}(s), s) ds, \quad (63)$$

that is to say, there exists an intention defined by the field action that infiltrates into the whole space of the particles influencing or "infecting" the temporary or instantaneous actions doing that the particles arrange themselves all and with added actions not in the

algebraic sense, but in the holistic sense. This action is the "conscience" that has the field to exercise their action in "intelligent" form that is to say, in organized form across his path integrals like the already described ones. Then extending the above mentioned integral to the whole space $\Omega(\Gamma)$, we have the synergic principle of the whole field X ,

$$\mathfrak{I}_{TOTAL} \geq \sum_j \int_{\gamma_j} \mathfrak{I}_j(x(s))d(x(s)), \tag{64}$$

the length and breadth of E . The order conscience is described by the operator of execution of a finite action of a field X , on a target (region of space that must be infiltrated by the action of the field which is that for which we realise our re-walked $\Omega(\Gamma)$).

How to measure this transference of conscience of transformation due to the field X , on an object defined by a portion of the space $\Omega(\Gamma)$? What is the limit of this supported action or transference of conscience so that it supplies effect in the portion of the space $\Omega(\Gamma)$, and the temporary or instantaneous actions for every particle x^i , are founded on only one synergic global action on Ω ?

We measure this transference of conscience (or intention) of X , on a particle $x(s)$, by means of the value of the integral of the intelligence spilled (path integral) given like (Bulnes et al., 2008):

$$\langle \tau_\alpha X(x(s)), x_\gamma \rangle = \int_{\Omega(\Gamma)} \mathfrak{I}(x_\delta \circ x_\sigma \circ x_\delta^{-1})(\phi_\sigma(x_\eta)\phi_\sigma(x_\gamma)\phi_\sigma^{-1}(x_\eta))\mu_\sigma, \tag{65}$$

We let at level conjecture and based on our investigations of nanotechnology and advanced quantum mechanics, that a sensor for the quantum sensitisation of any particle that receives an instruction given by a field X , must satisfy the inequality of Hilbert type (Bicheng, 2009), for this transference of conscience defined in (65) on the region $\Omega(\Gamma)$, to know (see figure 11 c):

$$\langle \tau_\alpha X(x(s))t_\gamma \rangle \geq \|\log \phi_\sigma(x_\eta)\|^a \|\log \mathfrak{I}(x_\sigma)\|^b, \text{ con } a = b = 2, \tag{66}$$

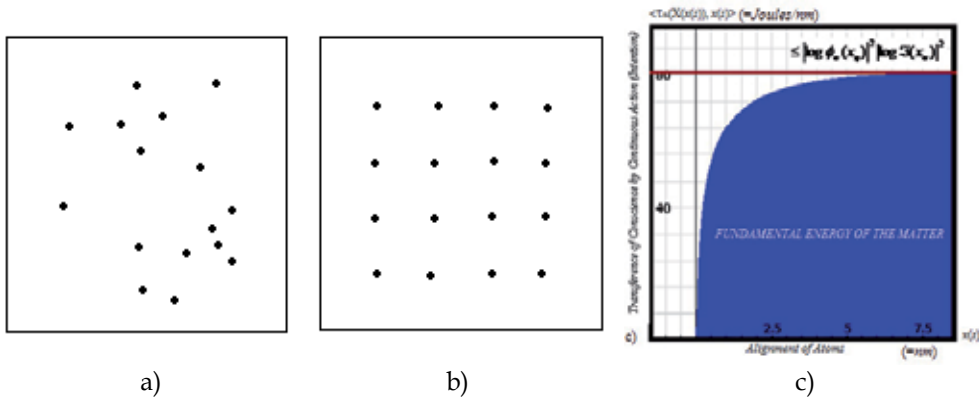

Fig. 11. a) Free particles. b) Transference of conscience in the particles. c) Transference of conscience by continuous action.

Example 3. A force is spilled $F(x(s))$, generated by a field that generates a "conscience" of order given by their Lagrangian. For it does not have to forget the principle of energy

conservation re-interpreted in the equations of Lagrange, and given for this force like $\frac{d}{dt} \left(\frac{\partial T}{\partial \dot{x}^j} \right) - \frac{\partial T}{\partial x^j} = F^j(x(s))$, (also acquaintances as "living forces") transmitting their

momentum in each i th-particle of the space E , creating a region infiltrated by path integrals of trajectories $\Omega(\Gamma)$, where the actions have effect. Here T , is their kinetic energy. It was considered to be a transference of conscience (intention) given by the product $\langle \tau_\alpha \mathfrak{T}(x(s)), x(s) \rangle = [(\log(x) + 2)^2] * [(\log(x) - 4.00000005)^2]$. Observe that the object obtains their finished transformation in an established limit. The above mentioned actions of alignment might be realised by displacements in ($= nm$) (see figure 11 b)).

6. Conclusions

Finally and based on the development that the quantum mechanics has had along their history, we can affirm that the classic quantum mechanics evolves to the advanced quantum mechanics (created by Feynman) and known like quantum electrodynamics reducing the uncertainty of Heissenberg of the frame of the classic quantum mechanics, on having established and having determined a path or trajectory of the region of space-time where a particle transits. Therefore the following step will demand the evolution of the quantum mechanics of Feynman to a synchronous quantum mechanics that should establish rules of path integrals that they bear to an effect of simultaneity and coordination of temporary actions on a set of particles that must behave under the same intensity that could be programmed across their "revisited" path integrals, producing a joint effect called synergy. The time and the space they are interchangeable in the quantum area as we can observe it in the integrals (61). Where a particle will be and when it will be there, are aspects that go together. This way the energy is not separated from the space-time and forms with them only one piece in the mosaic of the universe.

7. Acknowledgment

I am grateful with Carlos Sotero Zamora, Eng., and with Juan Maya Castellanos, Msc., for the help offered for the digital process of the images that were included in this chapter.

8. References

- Alonso, M. & Finn, E. J. (1968) *Fundamentals University Physics Vol. 3: Quantum and statistical physics* (1st Edition) Addison Wesley Publishing Co., ISBN: 0-201-00232-9, USA.
- Barry, S. (2005). *Functional Integration and Quantum Physics*. (2nd edition) AMS, 08218-3582-3, USA
- Bicheng, Y. (2009). *Hilbert-Type Integral Inequalities* (Bentham eBooks) <http://benthamscience.com/ebooks/9781608050550/index.htm>
- Bulnes, F., Bulnes F. Hernández, E. & Maya, J. (2011) Diagnosis and spectral encoding in integral medicine through electronic devices designed and developed by path integrals. *Journal of Nanotechnology in Engineering and Medicine*, Vol. 2, 2, 021009, (May, 2011), pp.(021009(1-10)) ISSN: 1949-2944
- Bulnes, F., Bulnes, F. H., Hernández, E., Maya, J. & Monroy, F. (2010) Integral medicine: new methods of organ-regeneration by cellular encoding through path integrals applied

- to the quantum medicine *Journal of Nanotechnology in Engineering and Medicine*, Vol. 1, Issue 3, 031009 issue (August, 2010), pp.(031009(1-7)), ISSN: 1949-2944
- Bulnes, F. (2008) Analysis of Prospective and Development of Effective Technologies through Integral Synergic Operators of the Mechanics, *Proceedings of Cuban Mechanical Engineering Congress/CCIA*, ISBN: ISBN: 978-959-261-281-5, ISPJAE, Habana, Cuba, 12-08
- Bulnes, F. & Shapiro, M. (2007) *On general theory of integral operators to analysis and geometry*, (1st edition) J. Cladwell, SEPI-IPN, IMUNAM, ISBN: 978-970-360-442-5, Mexico
- Bulnes, F. (2006a). *Doctoral course of mathematical electrodynamics, Proceedings of Conferences and Advanced Courses of Appliedmath 2*, ISBN: 970-360-358-0, Sepi-ESIME-IPN Mexico, 10-06
- Bulnes, F. (2006b). *Integral theory of the universe, Proceedings of Conferences and Advanced Courses of Appliedmath 2*, ISBN: 970-360-358-0, Sepi-ESIME-IPN Mexico, 10-06
- Bulnes, F. (2006c). *Design of Algorithms to the Master in Applied Informatics* (1st Edition), UCI, ISBN: 978-959-08-0950-7, Cuba
- Bulnes, F. (2005). *Conferences of Lie Groups* (1st Edition) Sepi-IPN, IMUNAM, ISBN: 970-36-028-43 Mexico
- Feynman, R. (1967) *The Character of Physical law*, (1st Edition) MIT Press Cambridge Mass, ISBN: 026-256-00-38, Massachusetts, USA
- Fujita, S. (1983). *Introduction to non-equilibrium quantum statistical mechanics* (2nd Edition), W. Krieger Pub. Co. (Malabar, Fla.), ISBN: 0898745934, USA
- Gorbatov, V. A. (1986). *Foundations of the discrete mathematics* (3rd Edition), Mir Moscu, Russia
- Holstein, B. R. (1991) *Topics in Advanced Quantum Mechanics* (3rd Edition), Addison-Wesley Publishing Co., (Advanced Book Program), ISBN: 0201-50820-6, USA
- Huggett, S. (1990). Cohomological and Twistor Diagrams, In: *Twistors in Mathematics and Physics*, Bayley T. N. and Baston, R. J., (156), (pp218-245), Cambridge University Press, ISBN: 978-052-139-783-4, UK
- Ionescu, L. M. (2004) Remarks on quantum theory and noncommutative geometry. *Int. J. Pure and Applied Math.*, Vol. 11, No.4, (10-08), pp.(363-376), ISSN:1842-6298
- Kac, V. (1990) *Infinite dimensional Lie Algebras* (3rd Edition), Cambridge University Press, ISBN: 0-521-37215-1, Cambridge, USA
- Kontsevich, M. (2003). Deformation quantization of Poisson manifolds I, *First European Congress of Mathematics, Lett.Math.Phys* Vol. 66, issue 3, pp.(157-216), ISSN: 0377-9017
- Landau, L., and Lifshitz. (1987) *Electrodynamics in Continuum Media* Vol. 8 (2nd Edition) Elsevier Butterworth Heinemann, Oxford, UK
- Marsden J. E., Abraham R. & Ratiu, T. (1983) *Manifolds, tensor analysis and applications* (2nd Edition), Addison-Wesley Publishing Co, ISBN: 0-201-10168-8, Massachusetts, USA
- Oppenheim, A. V., Willsky, A. S. & Young, I. T. (1983). *Signals and Systems* (1st Edition), Prentice Hall, ISBN: 0-13-809731-3, USA
- Penrose R. & Rindler, W. (1986). *Spinors, and twistor methods in space-time geometry* (1st Edition), Cambridge University Press, ISBN: 0-521-25267-9, CA, UK
- Schwinger, J. (1998). *Particles, sources and fields Vol. 1* (3rd Edition), Perseus Books, ISBN: 0-7382-0053-0, USA

- Shapiro, M. & Kravchenko, V. (1996) *Integral Representations for Spatial Models of Mathematical Physics* (1st Edition), CRC Press. Inc., ISBN: 0582297419, USA
- Simon, B. & Reed, M. (1980) *Functional analysis, Vol. 1 (Methods of modern mathematical physics)* (1st Edition), Academic Press, ISBN: 0125850506, N. Y., USA
- Sokolnikoff, S. I. (1964). *Tensor analysis: Theory and applications to geometry and mechanics of continua* (2nd Edition), John Wiley and Sons, ISBN: 0471810525 9780471810520, N. Y, USA
- Watanabe T. (2007), Configuration space integral for long n-knots and the Alexander polynomial. *Journal of Algebraic & Geometric Topology Mathematical Sciences Publishers*, Vol. 7, February 2007, pp.(47–92) ISSN 1472-2747

The ‘Computational Unified Field Theory’ (CUFT): Harmonizing Quantum and Relativistic Models and Beyond

Jonathan Bentwich
Brain Perfection LTD
Israel

1. Introduction

Perhaps the most troubling enigma in modern natural sciences is the principle contradiction that exists between quantum mechanics and Relativity theory (Greene, 2003) ; Indeed, this principle incompatibility between Quantum Mechanics and Relativity Theory propelled Einstein to relentlessly pursuit a 'Unified Field Theory' (Einstein, 1929, 1931, 1951) and subsequently prompted an intensive search for a 'Theory of Everything' (TOE) (Bagger & Lambert, 2007; Elis, 1986; Hawkins, 2002; Polchinski, 2007; Brumfiel, 2006). The principle contradictions that exist between quantum mechanics and relativity theory are:

- a. Probabilistic vs. deterministic models of physical reality:
Relativity theory is based on a positivistic model of ‘space-time’ in which an object or an event possesses clear definitive ‘space-time’, ‘energy-mass’ properties and which therefore gives rise to precise predictions regarding the prospective ‘behavior’ of any such object or event (e.g., given an accurate description of its initial system’s state). In contrast, the probabilistic interpretation of quantum mechanics posits the existence of only a ‘probability wave function’ which describes physical reality in terms of complimentary ‘energy-space’ or ‘temporal-mass’ uncertainty wave functions (Born, 1954; Heisenberg, 1927). This means that at any given point in time all we can determine (e.g., at the subatomic quantum level) is the statistical likelihood of a given particle or event to possesses a certain ‘spatial-energetic’ and ‘temporal-mass’ complimentary values. Moreover, the only probabilistic nature of quantum mechanics dictates that this statistical uncertainty is almost ‘infinite’ prior to our measurement of the particle’s physical properties and ‘collapses’ upon our interactive measurement of it into a relatively defined (complimentary) physical state... Hence, quantum mechanics may only provide us with a probabilistic prediction regarding the physical features of any given subatomic event – as opposed to the relativistic positivistic (deterministic) model of physical reality.
- b. “Simultaneous-entanglement” vs. “non-simultaneous-causality” features:
quantum and relativistic models also differ in their (a-causal) ‘*simultaneous-entanglement*’ vs. ‘*non-simultaneous-causal*’ features; In Relativity theory the speed of light represents the ultimate constraint imposed upon the transmission of any physical signal (or effect), whereas quantum mechanics advocates the existence of a

'simultaneous-entanglement' of quantum effects (e.g., that are not bound by the speed of light constraint). Hence, whereas the relativistic model is based on strict causality – i.e., which separates between any spatial-temporal 'cause' and 'effect' through the speed of light (non-simultaneous) signal barrier, quantum entanglement allows for 'a-causal' *simultaneous effects* that are independent of any light-speed constraint (Horodecki et al., 2007).

c. Single vs. multiple spatial-temporal modeling:

Finally, whereas Relativity theory focuses on the conceptualization of only a *single* spatial point at any given time instant – i.e., which therefore possesses a well defined spatial position, mass, energy, or temporal measures, quantum mechanics allows for the measurement (and conceptualization) of multiple spatial-temporal points (simultaneously) – giving rise to a (probability) '*wave function*'; Indeed, it is hereby hypothesized that this principle distinction between a *single spatial-temporal quantum 'particle'* or localized relativistic object (or event) and a *multi- spatial-temporal quantum 'wave' (function)* may both shed light on some of the key conceptual differences between quantum and relativistic modeling as well as potentially assist us in bridging the apparent gap between these two models of physical reality (based on a conceptually higher-ordered computational framework).

2. The 'Duality Principle': Constraining quantum and relativistic 'Self-Referential Ontological Computational System' (SROCS) paradigms

However, despite these (apparent) principle differences between quantum and relativistic models of physical reality it is hypothesized that both of these theories share a basic '*materialistic-reductionistic*' assumption underlying their basic (theoretical) computational structure: It is suggested that mutual to both quantum and relativistic theoretical models is a fundamental 'Self-Referential-Ontological-Computational-System' (SROCS) structure (Bentwich, 2003a, 2003b, 2003c, 2004, 2006) which assumes that it is possible to determine the 'existence' or 'non-existence' of a certain 'y' factor solely based on its *direct physical interaction* ($PR\{x,y\}/di1$) with another 'x' factor (e.g., at the same 'di1' computational level), thus:

$$\text{SROCS: } PR\{x,y\}/di1 \rightarrow ['y' \text{ or } '\neg y']/di1.$$

But, a strict computational-empirical analysis points out that such (quantum and relativistic) SROCS computational structure may also inevitably lead to '*logical inconsistency*' and inevitable consequent '*computational indeterminacy*' – i.e., a principle inability of the (hypothesized) SROCS computational structure to determine whether the particular 'y' element "exists" or "doesn't exist": Indeed (as will be shown below) such 'logical inconsistency' and subsequent 'computational indeterminacy' occurs in the specific case in which the direct physical interaction between the 'x' and 'y' factors leads to a situation in which the 'y' factor "*doesn't exist*", which is termed: a 'Self-Referential-Ontological-Negative-System', SRONCS)... However, since there exist ample empirical evidence that both quantum and relativistic computational systems *are capable* of determining whether a particular 'y' element (e.g., state/s or value/s) "exists" or "doesn't exist" then this contradicts the SRONCS (above mentioned) inevitable 'computational indeterminacy', thereby calling for a reexamination of the currently assumed quantum and relativistic SROCS/SRONCS computational structure;

Indeed, this analysis (e.g., delineated below) points at the existence of a (new) computational '*Duality Principle*' which asserts that the computation of any hypothetical quantum or relativistic (x,y) relationship/s must take place at a *conceptually higher-ordered computational framework 'D2'* – e.g., that is (in principle) irreducible to any direct (or even indirect) physical interaction between the (quantum or relativistic) 'x' and 'y' factors (but which can nevertheless determine the association between any two given 'x' and 'y' factors) (Bentwich, 2003a, 2003b, 2003c, 2004, 2006a, 2006b).

In the case of Relativity theory, such basic SROCS computational structure pertains to the computation of any spatial-temporal or energy-mass value/s of any given event (or object) – solely based on its *direct physical interaction* with any hypothetical (differential) relativistic observer; We can therefore represent any such (hypothetical) spatial-temporal or energy-mass value/s (of any given event or object) as a particular '*Phenomenon*': 'P[s-t (i...n), e-m (i...n)]'; Therefore, based on the (above) relativistic 'materialistic-reductionistic' assumption whereby the specific value of any (spatial-temporal or energy-mass) 'Phenomenon' value is computed solely based on its direct physical interaction ('di1') with a specific (hypothetical differential) relativistic observer, we obtain the (above mentioned) SROCS computational structure:

$$\text{SROCS: PR}\{\text{O-diff, P[s-t (i...n), e-m (i...n)]}\} / \text{di1} \\ \rightarrow \{ \text{'P[s-t (i), e-m (i)]' or 'not P[s-t (i), e-m (i)]'} \}.$$

Hence, according to the above mentioned SROCS computational structure the relativistic SROCS computes the "existence" or "non-existence" of any particular 'Phenomenon' (e.g., specific 'spatial-temporal' or 'energy-mass' 'i' value/s of any given object/event) – solely based upon the direct physical interaction (PR.../di1) between the potential (exhaustive hypothetical) values of this Phenomenon ('P[s-t (i...n), e-m (i...n)]') and any hypothetical differential relativistic observer; But, note that the relativistic SROCS computational structure assumes that it is solely through the direct physical interaction between any series of (hypothetical differential) relativistic observer/s and the Phenomenon's (entire spectrum of possible spatial-temporal or energy-mass) value/s – that a particular 'Phenomenon' (spatial-temporal or energy mass) value is computed. The relativistic SROCS computational structure assumes that it is solely through the direct physical interaction between any series of (hypothetical differential) relativistic observer/s and the Phenomenon's (entire spectrum of possible spatial-temporal or energy-mass) value/s – that the particular 'Phenomenon' (spatial-temporal or energy-mass) value is computed. But, a thorough analysis of this SROCS computational structure indicates that in the specific case in which the direct physical interaction between any hypothetical differential relativistic observer/s and the Phenomenon's whole spectrum of potential values – leads to the "non-existence" of all of the other 'space-time' or 'energy-mass' values that were not measured by a particular relativistic observer ('O-i') (at the same 'di1' computational level):

$$\text{SRONCS: PR}\{\text{O-diff}(i...n), \text{P[s-t (i...n), e-m (i...n)]}\} \rightarrow \text{'not P[s-t (not i), e-m (not i)]O-i' / di1}.$$

However, this SRONCS computational structure inevitably leads to the (above mentioned) 'logical inconsistency' and '*computational indeterminacy*':

This is because according to this SRONCS computational structure all of the other 'Phenomenon' values (e.g., 'space-time' or 'energy-mass values) – which do not correspond to the specifically measured 'space-time' or 'energy-mass' {i} values (i.e., that are measured by a particular corresponding 'O-diff-i' relativistic observer): P[{s-t ≠ i} or {e-m ≠ i}] are

necessarily computed by the SRONCS paradigmatic structure to both “*exist*” AND “*not exist*” – at the same ‘di1’ computational level: according to this SRONCS computational structure all of the other ‘Phenomenon’ values (e.g., ‘space-time’ or ‘energy-mass values’) – which do not correspond to the specifically measured ‘space-time’ or ‘energy-mass’ {i} values (i.e., that are measured by a particular corresponding ‘O-diff-i relativistic observer’): $P[\{s-t \neq i\} \text{ or } \{e-m \neq i\}]$ are necessarily computed by the SRONCS paradigmatic structure to both “*exist*” AND “*not exist*” – at the same ‘di1’ computational level:

SRONCS: $PR\{O\text{-diff}(i\dots n), P[s\text{-}t(i\dots n), e\text{-}m(i\dots n)]\} \rightarrow \text{‘not } P[s\text{-}t(\text{not } i), e\text{-}m(\text{not } i)]O\text{-}i\text{’} / \text{di1}.$

But, given the SROCS/SRONCS strong ‘materialistic-reductionistic’ working assumption – i.e., that the computation of the “existence” or “non-existence” of the particular $P[\{s-t \neq i\}, \{e-m \neq i\}]$ values solely depends on its direct physical interaction with the series of (potential) differential observers at the ‘di1’ computational level, then the above SRONCS computational assertion that the particular $P[\{s-t \neq i\}, \{e-m \neq i\}]$ values both “exist” and “don’t exist” at the same ‘di1’ computational level inevitably also leads to both ‘logical inconsistency’ and a closely linked ‘computational indeterminacy’ – e.g., conceptual computational inability of such ‘di1’ computational level to determine whether the $P[\{s-t \neq i\}, \{e-m \neq i\}]$ values “exist” or “doesn’t exist”...

But, since there exists ample relativistic empirical evidence pointing at the capacity of any relativistic observer to determine whether or not a particular ‘ $P[\{s-t \neq i\}, \{e-m \neq i\}]$ ’ “exists” or “doesn’t exist”, then a novel (hypothetical) computational ‘*Duality Principle*’ asserts that the determination of the “existence” or “non-existence” of any given $P[s-t(i\dots n), e-m(i\dots n)]$ can only be computed at a conceptually higher-ordered ‘D2’ computational level e.g., that is in principle irreducible to any direct or even indirect physical interactions between the full range of possible ‘Phenomenon’ values ‘ $P[s-t(i\dots n), e-m(i\dots n)]$ ’ and any one of the potential range of (differential) relativistic observers:

‘D2’: $P[\{s-t(i\dots n) e-m(i\dots n), O\text{-}r(st\text{-}i)\}, \{P[s\text{-}t(i+n) e-m(i+n), O\text{-}r(st\text{-}i+n)]\}]$
 $\neq PR\{O\text{-}diff, P[s\text{-}t(i\dots n) e-m(i\dots n)]\} / \text{di1}$

Note that the computational constraint imposed by the Duality Principle is *conceptual* in nature – i.e., as it asserts the conceptual computational inability to determine the “existence” or “non-existence” of any (hypothetical) ‘Phenomenon’ (e.g., ‘space-time’ event/s or ‘energy-mass’ object value/s) from within its direct physical interaction with any (hypothetical) differential relativistic observer; Indeed, a closer examination of the abovementioned SROCS/SRONCS relativistic computational structure may indicate that the computational constraint imposed by the Duality Principle is not limited to only *direct physical interaction* between any ‘Phenomenon’ (e.g., space-time or energy-mass value/s) and any (hypothetical) differential relativistic observer/s, but rather extends to any *direct or indirect physical interaction* (between any such ‘Phenomenon’ and any potential differential relativistic observer/s); In order to prove this broader applicability of the computational Duality Principle – as negating the possibility of determining the “existence” or “non-existence” of any such ‘Phenomenon’ from within its *direct or indirect* physical interaction/s with any (hypothetical) differential relativistic observer/s (e.g., but only from a conceptually higher-ordered hypothetical computational level ‘D2’) let us assume that it is *possible* to determine the precise value/s of any given ‘Phenomenon’ based on its *indirect interaction* with another intervening variable (or computational level)

'd2' (which may receive any information or input/s or effect/s etc. from any direct physical interaction/s between the given 'Phenomenon' and any hypothetical differential relativistic observer at the 'di1' level);

$$\text{SROCS: PR}\{O\text{-diff}(i\dots n), P[s\text{-t}(i\dots n), e\text{-m}(i\dots n)]\}/di1 \\ \rightarrow \{P[s\text{-t}(i), e\text{-m}(i)] \text{ or } 'not P[s\text{-t}(i), e\text{-m}(i)]O\text{-}i'\}/di2.$$

But, a closer analysis of the this hypothetical 'di2' (second) intervening computational level (or factor/s) as possibly being able to determine whether any particular space-time event or energy-mass object "exists" or "doesn't exist" may indicate that it precisely replicates the same SROCS/SRONCS ('problematic') computational structure which has been shown to be constrained by the (novel) computational 'Duality Principle'. This is because despite the (new) assumption whereby the computation of the "existence" or "non-existence" of any particular 'Phenomenon' (e.g., space-time or energy-mass) value is computed at a different 'di2' computational level (or factor/s etc.), the SROCS/SRONCS *intrinsic 'materialistic-reductionistic'* computational structure is such that it assumes that the determination of the "existence"/"non-existence" of any particular Phenomenon value/s is '*solely caused*' (or 'determined') *by the direct physical interaction* between that 'Phenomenon' and any hypothetical (differential) relativistic observer/s, which is represented by the *causal arrow* " \rightarrow " embedded within the relativistic SROCS/SRONCS computational structure :

$$\text{SROCS: PR}\{O\text{-diff}(i\dots n), P[s\text{-t}(i\dots n), e\text{-m}(i\dots n)]\}/di1 \\ \rightarrow \{P[s\text{-t}(i), e\text{-m}(i)] \text{ or } 'not P[s\text{-t}(i), e\text{-m}(i)]O\text{-}i'\}/di2.$$

Thus, even though the direct physical interaction between the 'Phenomenon' and the differential relativistic observer seem to take place at the 'di1' computational level whereas the determination of the "existence"/"non-existence" of a particular Phenomenon value appears to be carried out at a different 'di2' computational level, the actual (embedded) computational structure still represents a SROCS/SRONCS paradigm. This is because even this new SROCS/SRONCS computational structure still maintains the strict 'materialistic-reductionistic' working assumption whereby it is solely the direct physical interaction between the Phenomenon and the differential relativistic observer that determines the "existence"/"non-existence" of a particular Phenomenon value; An alternate way of proving that the SROCS/SRONCS computational structure remains unaltered (e.g., even when we assume that the computation of the "existence" or "non-existence" of the particular 'Phenomenon' value may take place at another 'di2' computational level) is based on the fact that due to its (above mentioned) 'materialistic-reductionistic' working hypothesis - the determination of the "existence" or "non-existence" of the particular 'Phenomenon' value is solely computed based on the information obtained from the direct physical interaction between the 'Phenomenon' and the series of potential differential observers (at the 'di1' computational level); Hence, in effect there is a total contingency of the determination of the "existence"/"non-existence" of the particular 'Phenomenon' value (at the hypothetical 'di2' computational level) upon the direct physical interaction between this 'Phenomenon' and any differential relativistic observer (at the 'di1' level) which therefore does not alter the 'di1' SROCS computational structure, and may be expressed thus:

$$\text{SRONCS: PR}\{O\text{-diff}(i\dots n), P[s\text{-t}(i\dots n), e\text{-m}(i\dots n)]\} \rightarrow 'not P[\{s\text{-t} \neq i\}, \{e\text{-m} \neq i\}]O\text{-}i' / di1 \text{ or } di2.$$

(Note: precisely due to the above mentioned total “existence”/“non-existence” of the particular Phenomenon value (i) at ‘di2’ upon input from the Phenomenon’s direct physical interaction with any differential relativistic observer at ‘di1’ it may be more convenient to formally represent this SROCS computational structure as occurring altogether – either at the ‘di1’ or ‘di2’ computational level, as presented above);

However, as proven by the Duality Principle (above), given the fact that there exists ample empirical evidence indicating the capacity of relativistic (computational) systems to determine whether a particular ‘Phenomenon’ (space-time or energy-mass) value “exists” or “doesn’t exist”, then the broader extension of the Duality Principle evinces that it is not possible (e.g., in principle) to determine such “existence” or “non-existence” of any particular ‘Phenomenon’ (e.g., space-time or energy-mass) value from *within* any direct or indirect physical interaction/s between any such ‘Phenomenon’ and any (hypothetical) series of differential relativistic observer/s; Instead, the ‘Duality Principle’ postulates that the determination of any ‘Phenomenon’ (e.g., ‘space-time’ or energy-mass) values can only be determined by a conceptually higher ordered ‘D2’ computational level which is capable of determining the ‘co-occurrence/s’ of specific Phenomenon values and corresponding differential relativistic observers’ measurements (e.g., and which is irreducible to any direct or indirect physical interactions between such differential relativistic observer/s and any Phenomenon value/s):

$$\begin{aligned} \text{‘D2’}: & \{P\{s-t(i) \text{ e-m } (i), O-r(st-i)\}; \dots P\{s-t(i+n) \text{ e-m } (i+n), O-r(st-i+n)\}\} \\ & \neq PR\{O\text{-diff}(i\dots n), P\{s-t(i\dots n) \text{ e-m } (i\dots n)\}\} / di1 \end{aligned}$$

Hence, a thorough reexamination of Relativity’s SROCS computational structure (e.g., which assumes that the determination of any ‘space-time’ or ‘energy-mass’ Phenomenon value is solely determined based on that particular event’s or object’s direct or indirect physical interaction/s with any one of a series of potential relativistic observers) has led to the recognition of a (novel) computational ‘Duality Principle’; This ‘Duality Principle’ proves that it is not possible (in principle) to determine any such space-time or energy-mass ‘Phenomenon’ values based on any hypothetical direct or indirect physical interaction between such ‘Phenomenon’ and any hypothetical series of (differential) relativistic observer/s; Rather, according to this novel computational Duality Principle the determination of any space-time or energy-mass relativistic value can only be computed based on a conceptually higher-ordered ‘D2’ computational level (e.g., which is again in principle irreducible to any hypothetical direct or indirect physical interaction between any differential relativistic observer/s and any space-time or energy-mass Phenomenon); Such conceptually higher-ordered ‘D2’ computational level is also postulated to compute the ‘co-occurrences’ of any differential relativistic observer/s’ and corresponding ‘Phenomenon’ (e.g., space-time or energy-mass value/s)...

Intriguingly, it also hypothesized that the same precise SROCS/SRONCS computational structure may underlie the quantum probabilistic interpretation of the ‘probability wave function’ and ‘uncertainty principle’; Indeed, it is hereby hypothesized that precisely the same SROCS/SRONCS computational structure may pertain to the quantum mechanical computation of the physical properties of any given subatomic ‘target’ (t) (e.g., assumed to be dispersed all along a probability wave function) which is hypothesized to be determined solely through its direct physical interaction with another subatomic complimentary ‘probe’ (P (‘e/s’ or ‘t/m’)) entity, thus:

$$\begin{aligned} \text{SROCS: } & PR\{P\{e/s \text{ or } t/m\}, t [e/s(i\dots n), t/m(i\dots n)]\} \\ & \rightarrow [t [e/s(i), t/m(i)] \text{ or } \text{‘not } t [s/e(i), t/m(i)] \text{’} / di1 \end{aligned}$$

In a nutshell, it is suggested that this SROCS/SRONCS computational structure accurately represents the (current) probabilistic interpretation of quantum mechanics in that it describes the basic working hypothesis of quantum mechanics wherein it is assumed that the determination of the particular (complimentary) 'spatial-energetic' or 'temporal-mass' values of any given subatomic 'target' particle - i.e., which is assumed to be dispersed probabilistically all along the probability wave function's (complimentary) spatial-energetic and temporal-mass values, occurs through the direct physical interaction of such probability wave function dispersed 'target' entity with another subatomic measuring 'probe' element; Moreover, it is assumed that this direct physical interaction between the probability wave function dispersed 'target' element and the subatomic probe element constitutes the sole (computational) means for the "collapse" of the target's probability wave function to a singular complimentary target value: This inevitably produces a SROCS computational structure which possesses the potential of expressing a SRONCS condition, thus:

$$\text{SRONCS: PR}\{P('e/s' \text{ or } 't/m'), t [e/s (i\dots n), t/m (i\dots n)]\} \rightarrow ' \text{not } t [e/s (\neq i), t/m (\neq i)] ' / \text{di1}$$

wherein the probabilistically distributed 'target' element (e.g., all along the complimentary 'spatial-energetic' or 'temporal-mass' probability wave function) which possesses all the possible spectrum of such 'spatial-energetic' or 'temporal-mass' values: $t [s/e (i\dots n), t/m (i\dots n)]$ "collapses" - solely as a result of its direct physical interaction with another subatomic 'probe' element (which also possesses complimentary 'spatial-energetic' and 'temporal-mass' properties); Indeed, it is this assumed direct physical interaction between the subatomic 'probe' and probabilistically distributed 'target' wave function which "collapses" the target's (complimentary) wave function, i.e., to produce only a *single* (complimentary) spatial-energetic or temporal-mass *measured* value (e.g., $t [e-s (i), t-m (i)]$)- which therefore *negates all of the other "non-collapsed" spatial-energetic or temporal-mass complimentary values* (e.g., 'not $t [e-s (\neq i), t-m (\neq i)]$ ') of the target's ('pre-collapsed') wave function!

But, as we've seen earlier (in the case of the relativistic SRONCS), such SRONCS computational structure invariably leads to both 'logical inconsistency' and subsequent 'computational indeterminacy': This is because the above mentioned SRONCS condition essentially advocates that all of the "non-collapsed" complimentary 'target' values (i.e., $t [s-e \neq i \text{ or } t-m \neq i]$) seem to both "exist" AND "not exist" at the same 'di1' computational level - thereby constituting a 'logical inconsistency'!? But, since the basic 'materialistic-reductionistic' working hypothesis underlying the SROCS/SRONCS computational structure also assumes that the determination of any particular target complimentary (spatial-energetic or temporal-mass) value can *only* be determined based on the direct physical interaction between the target probability wave function's distribution and a subatomic 'probe' element - e.g., *at the same 'di1' computational level*, then the above mentioned 'logical inconsistency' invariably also leads to 'computational indeterminacy', e.g., a principle inability to determine whether any such "non-collapsed" complimentary 'target' values (i.e., $t [s-e \neq i \text{ or } t-m \neq i]$) "exists" or "doesn't exist"... However, as noted above, since there exists ample empirical evidence indicating the *capacity* of quantum (computational) systems to determine whether any such $t [e-s (i\dots n), t-m (i\dots n)]$ quantum target value "exists" or "doesn't exist" the Duality Principle once again asserts the need to place the computation regarding the determination of any pairs of subatomic complimentary 'probe' and 'target' values at a conceptually higher-ordered 'D2' level (e.g., that is in principle *irreducible to any direct physical interactions between them*).

Finally, as shown in the case of the relativistic SROCS/SRONCS paradigm, the conceptual computational constraint imposed by the Duality Principle further expands to include not only strictly '*direct*' physical interaction/s between the subatomic 'probe' and 'target' elements but also any other hypothetical '*indirect*' interaction/s, elements, effects, or even light-signals, information, etc. – that may mediate between these subatomic 'probe' and 'target' elements;

This is because even if we assume that the determination of the "existence" or "non-existence" of any particular subatomic 'target' (spatial-energetic or temporal-mass) value can occur through a (second intervening or mediating) 'di2' computational interaction, entity, process or signal/s transfer we still obtain the same SROCS/SRONCS computational structure which has been shown to be constrained by the computational Duality Principle:

$$\begin{aligned} \text{SROCS: } & \text{PR}\{P('e/s' \text{ or } 't/m'), t [e/s (i\dots n), t/m (i\dots n)]\}/\text{di1} \\ & \rightarrow t [(e/s (\neq i), t/m (\neq i)) \text{ or } (' \text{not } t [e/s (\neq i), t/m (\neq i)])/\text{di2}. \end{aligned}$$

The rationale for asserting that this (novel) computational instant precisely replicates the same SROCS/SRONCS computational structure (e.g., noted above) arises (once again) from the recognition of the strict '*materialistic-reductionistic*' "*causal*" connection that is assumed to exist between the direct physical interaction between the subatomic 'probe' and 'target' elements (e.g., taking place at the 'di1' level) and the hypothetical 'di2' computational level – and which is assumed to *solely determine* whether a particular target value '*t [s/e (i), t/m (i)]*' "exists" or "doesn't exist"; This is because since the (abovementioned) basic materialistic-reductionistic causal assumption whereby the 'di2' determination of the "existence"/"non-existence" of any specific (spatial-energetic or temporal-mass) 'target' value is *solely determined by the direct 'probe-target' physical interaction* at the 'di1' level value, therefore the logical or computational structure of the (abovementioned) SROCS/SRONCS is replicated; Specifically, the case of the SRONCS postulates the "existence" of the entire spectrum of possible target values *t [e-s (i\dots n), t-m (i\dots n)]* at the 'di1' direct physical interaction between the 'probe' and 'target' entities – but also asserts the "non-existence" of all the "non-collapsed" target values at the 'di2' computational level (e.g., '*not t [e/s (\neq i), t/m (\neq i)]*'); This intrinsic contradiction obviously constitutes the abovementioned 'logical inconsistency' and ensuing 'computational indeterminacy' (that are contradicted by known empirical findings).

Indeed, this SRONCS structure is computationally equivalent to the abovementioned SRONCS: $\text{PR}\{P('e-s' \text{ or } 't-m'), t [e-s (i\dots n), t-m (i\dots n)]\} \rightarrow ' \text{not } t [e-s (i), t-m (i)]'/\text{di1}$, since the determination of the '*t [e-s (i), t-m (i)]*' or '*not t [e-s (i), t-m (i)]*' is solely determined based on the direct physical interaction at 'di1'. Therefore, also the 'logical inconsistency' and 'computational indeterminacy' (mentioned above) ensues which is contradicted by robust empirical evidence that inevitably leads to the Duality Principle's assertion regarding the determination of any (hypothetical) 'probe-target' pair/s at a conceptually higher-ordered 'D2' computational level:

$$\begin{aligned} \text{D2: } & \{[P('e/s' \text{ or } 't/m')i, t (e/s(i), t/m(i))]; \\ & \dots[P('e/s' \text{ or } 't/m')n, t (e/s(n), t/m(n))]\} \\ & \neq \text{PR}\{P('e/s' \text{ or } 't/m'), t [e/s (i\dots n), t/m (i\dots n)]\}/\text{di1} \end{aligned}$$

Therefore, an analysis of the basic SROCS/SRONCS computational structure underlying both relativistic as well as quantum's computational paradigms has led to the identification

of a novel computational 'Duality Principle' which constrains each of these quantum and relativistic SROCS/SRONCS computational paradigms and ultimately points at the inevitable existence of a conceptually higher-ordered 'D2' computational level; Based upon the Duality Principle's identification of such a conceptually higher-ordered 'D2' computational level (which alone can determine any relativistic 'Phenomenon' or any quantum spatial-energetic or temporal-mass target value, it also postulates the computational products of this conceptually higher-ordered 'D2' computational level – as the determination of the “co-occurrence” of any relativistic Phenomenon-relativistic observer pair/s or of any quantum 'probe-target' (complimentary) pair/s; Thus, the first step towards the hypothetical unification of quantum and relativistic theoretical frameworks within a singular (conceptually higher-ordered) model is the identification of a singular computational 'Duality Principle' constraining both quantum and relativistic (underlying) SROCS paradigms and its emerging conceptually higher-ordered singular 'D2' computational level (which produces 'co-occurring' quantum 'probe-target' or relativistic 'observer-Phenomenon' pairs) – as the only feasible computational level (or means) capable of determining any quantum (space-energy or temporal-mass) 'probe-target' relationship or any 'observer-Phenomenon' relativistic relationship/s.

3. 'D2': A singular 'a-causal' computational framework

There are two (key) questions that arise in connection with the discovery of the Duality Principle's conceptually higher-ordered (novel) 'D2' computational framework:

- a. Is there a *singular* (mutual) 'D2' computational level that underlies *both* quantum and relativistic (basic) SROCS paradigms?
- b. What may be the D2 '*a-causal*' *computational framework* – which transcends the SROCS' computational constraints imposed by the Duality Principle?

In order to answer the first question, let's apply once again the conceptual proof of the 'Duality Principle' regarding the untenable computational structure of the SROCS – which (it is suggested) is applicable (once again) when we try to determine the physical relationship/s between these two potential quantum and relativistic 'D2' computational frameworks; Specifically, the Duality Principle proves that it is not possible (e.g., in *principle*) to maintain two such “independent” (conceptually higher-ordered) 'D2' computational frameworks; Rather, that there can only exist a *singular conceptually higher-ordered 'D2' computational framework* which coalesces the above mentioned quantum and relativistic 'D2' computational levels; Let's suppose there exist two “*separate*” such conceptually higher-ordered computational frameworks: 'D21' and 'D22' as underlying and constraining quantum and relativistic modeling (e.g., as proven above through the application of the Duality Principle to the two principle SROCS/SRONCS computational paradigms underlying current quantum and relativistic modeling). Then, according to the Duality Principle this would imply that in order to be able to determine any hypothetical physical relationship between quantum [qi_1] and relativistic [ri_2] entities or processes (i.e., that exist at the above mentioned hypothetical corresponding D21 quantum and D22 relativistic computational levels) – we would necessarily need a conceptually higher-ordered 'D3' that is (again in principle) irreducible to the lower-ordered D21(qi_1) and D22(ri_2) physical interactions at the D2 computational level. This is because otherwise, the determination of the “existence” or “non-existence” of any such

hypothetical quantum or relativistic phenomena would be carried out at the same computational level ('D2') as the direct physical interaction between these (hypothetical) quantum and relativistic entities (or processes), thereby precisely replicating the SROCS structure (that was shown constrained by the Duality Principle), thus:

$$\begin{aligned} & \text{SROCS/D2: PR}[\text{'qi}\{D21\}', \text{ri}\{D22\}] \\ & \rightarrow [(\text{'qi}\{D21\} \text{ or } \text{ri}\{D22\}') \text{ or } (\text{'not qi}\{D21\}' \text{ or } \text{'not ri}\{D22\}')] / D2. \end{aligned}$$

But, since we already know that the Duality Principle proves the conceptual computational inability to carry out the conceptually higher-ordered computation at the same computational level (e.g., in this case termed: 'D2') as the direct physical interaction between any two given elements, then we are forced (once again) to conclude that there must be only *one singular conceptually higher-ordered D2* computational level underlying both quantum and relativistic SROCS models. Therefore, we are led to the (inevitable) conclusion whereby there may only exist *one* conceptually higher-ordered 'D2' computational framework which underlies (and constrains) both quantum and relativistic relationships.

A critical element arising from the computational Duality Principle is therefore the recognition that it is not possible (in principle) to determine (or compute) any quantum or relativistic relationships based on any 'direct' physical relationship, (at 'di2' or indirect physical relationship/s ('di3') , (as shown above) that may exist between any hypothetical differential relativistic observer and any hypothetical 'Phenomenon' or between any complimentary subatomic 'probe' measurement and the target's (assumed) probability 'wave-function'; Hence, the untenable SROCS/SRONCS computational structure evident in the case of attempting to determine the (direct or indirect) physical relationship/s between the conceptually higher-ordered 'D21' quantum and 'D22' relativistic computational frameworks once again points at the Duality Principle's conceptual computational constraint which can only allow for only a *singular conceptually higher-ordered 'D2' computational framework* - as underlying *both* quantum and relativistic phenomena (which constitutes the answer to the first theoretical question, above).

Next, we consider the second (above mentioned) theoretical question - i.e., provided that (according to the Duality Principle) there can only be a *singular conceptually higher-ordered 'D2' computational framework* as underlying both quantum and relativistic phenomena, what may be its computational characteristics? It is suggested that based on the recognition of the Duality Principle's singular conceptually higher-ordered 'D2' computational framework - which necessarily underlies both quantum and relativistic phenomena, it is also possible to answer the second (above mentioned) question regarding the computational characteristics of such higher-ordered (singular) 'D2' framework; Specifically, the Duality Principle's (above) proof indicates that rather than the existence of any direct (or indirect) 'materialistic-reductionistic' physical interaction between any hypothetical differential relativistic 'observer' and any corresponding 'Phenomena', or between any complimentary subatomic 'probe' element and probability wave function 'target' there exists a singular conceptually higher-ordered 'D2' computational framework which simply computes the "co-occurrences" of any of these quantum or relativistic (differential) 'observer/s' and corresponding 'Phenomenon' value/s or between any quantum subatomic 'probe' and 'target' elements...

Therefore, the singular conceptually higher-ordered 'D2' computational framework produces an "*a-causal*" computation which computes the 'co-occurrences' of any range of quantum 'probe-target' or relativistic 'observer-Phenomenon' pairs thus:

1. D2: {P('e-s' or 't-m'), T [e-s (i), t-m (i)]; ... P('e+n/s+n' or 't+n/m+n'), T [(e+n) (s+n), (t+n) (m+n)]} ≠ PR{[P('e-s' or 't-m'), T (e-s (i), t-m (i)); ... P('e+n/s+n' or 't+n/m+n'), T (e+n) (s+n), (t+n) (m+n)]}/di1
2. 'D2': {P [s-t (i...n) e-m (i...n), O-r(st-i)]; ... P[s-t (i+n) e-m (i+n), O-r(st-i+n)]} ≠ PR{O-diff, P[s-t (i...n), e-m (i...n)]}/di1.

The key point to be noted (within this context) is that such 'a-causal' computation negates or precludes the possibility of any "real" 'material-causal' interaction taking place at either quantum or relativistic levels! In other words, the Duality Principle's negation of the fundamental quantum or relativistic SROCS/SRONCS computational structure (e.g., as invariably leading to both 'logical inconsistency' and 'computational indeterminacy' that are contradicted by robust quantum and relativistic empirical data) also necessarily negates the existence of any (real) 'causal-material' interaction between or within any quantum or relativistic phenomena - e.g., at the conceptually higher-ordered 'D2' computational level. In order to prove that the Duality Principle constraining the basic (materialistic-reductionistic) SROCS/SRONCS computational structure also necessarily points at the conceptual computational inability of such SROCS/SRONCS paradigms to determine the existence of any (real) 'causal-material' interactions (e.g., between any exhaustive series of x and y factors, interactions etc.) let us reexamine (once again) the SROCS/SRONCS working hypothesis wherein it is possible to determine whether a certain 'x' factor 'causes' the 'existence' or 'non-existence' of the particular 'y' factor:

Let's suppose it is possible for the SROCS/SRONCS direct physical (quantum or relativistic) interaction between the 'x' and 'y' (exhaustive series') factors to causally determine the 'existence; or 'non-existence' of the 'y' factor. In its most general formulation this would imply that:

$$\text{SROCS: PR}\{x,y\}/di1 \rightarrow [y' \text{ or 'not } y']/di1$$

But, as we've already seen (earlier), such SROCS computational structure invariably also contains the special case of a SRONCS of the form:

$$\text{SRONCS: PR}\{x,y\} \rightarrow \text{'not } y'/di1$$

However, this SRONCS structure inevitably leads to both 'logical inconsistency' and 'computational indeterminacy' which are contradicted by empirical findings (e.g., in the case of quantum and relativistic phenomena).

Therefore, the Duality Principle incontrovertibly proves that the basic materialistic-reductionistic SROCS/SRONCS paradigmatic structure underlying the current quantum and relativistic theoretical models must be replaced by a conceptually higher-ordered (singular) 'D2' computation which cannot (in principle) contain any SROCS/SRONCS 'causal-material' relationships - e.g., wherein any hypothetical 'y' element is "caused" by its direct (or indirect) physical interaction with another (exhaustive) X{1...n} series. As pointed out (above), the only such possible conceptually higher-ordered 'D2' computation consists of an 'a-causal association' between pairs of D2: {(x_i, y_i)... (x_n, y_n)}.

The essential point to be noted is that the Duality Principle thereby proves the conceptual computational unfeasibility of the currently assumed 'materialistic-reductionistic' SROCS/SRONCS structure - including the existence of any hypothetical 'causal-material' interaction between any exhaustive 'x' and 'y' series! This means that in both quantum and relativistic domains the determination of any hypothetical (exhaustive) spatial-temporal

event or energy-mass object, or of any complimentary spatial-energetic or temporal subatomic target – there cannot (in principle) exist any ‘causal-material’ interaction between the relativistic event and any differential relativistic observer or between the subatomic probe and target elements... Instead, the Duality Principle proves that the only viable means for determining any such exhaustive hypothetical relativistic or quantum relationship is through the conceptually higher-ordered singular ‘a-causal’ D2 association of certain pairs of spatial-temporal or energy-mass values and corresponding relativistic observer frameworks or between pairs of subatomic probe and corresponding complimentary pairs of spatial-energetic or temporal-mass target values...

However, if indeed, the entire range of quantum and relativistic phenomena must necessarily be based upon a singular conceptually higher-ordered ‘D2’ computational level – which can only compute the “co-occurrences” of quantum ‘probe-target’ or relativistic ‘observer-Phenomenon’ pairs, but which precludes the possibility of any “real” ‘material-causal’ relationship/s existing between any such quantum (‘probe-target’) or relativistic (‘observer-Phenomenon’) pairs, then this necessitates a potential significant reformulation of both quantum and relativistic theoretical models based on the Duality Principle’s asserted conceptually higher-ordered singular ‘D2’ ‘a-causal’ computational framework; This is because the current formulation of both quantum and relativistic theoretical frameworks is deeply anchored in- and dependent upon- precisely such direct (or indirect) physical interactions between a differential relativistic observer and any hypothetical (range of) ‘Phenomenon’ (e.g., as defined earlier), or between any subatomic (complimentary) ‘probe’ element and a probabilistically dispersed ‘target’ wave function. Thus, for instance, the entire theoretical structure of Relativity Theory rests upon the assumption that the differential physical measurements of different observers travelling at different speeds relative to any given object (or event) arises from a direct physical interaction between a (constant velocity) speed of light signal and the differentially mobilized observer/s... In contrast, the (novel) Duality Principle proves the conceptual computational inability to determine any such relativistic differential Phenomenon values – based on any direct or indirect physical interaction between any (hypothetical) differential relativistic observer and any given ‘Phenomenon’ (at their ‘di1’ or even ‘di2’ computational levels), but only from the conceptually higher-ordered ‘D2’ computational level through an ‘a-causal’ computation of the “co-occurrences” of any (differential) relativistic observer and (corresponding) Phenomenon! Hence, to the extent that we accept the Duality Principle’s conceptual computational proof for the existence of a singular higher-ordered ‘a-causal D2’ computational framework – as underlying both quantum and relativistic theoretical models, then Relativity’s well-validated empirical findings must be reformulated based on such higher-ordered ‘D2 a-causal computation’ framework...

Likewise, in the case of Quantum Mechanical theory it is suggested that the current formalization critically depends on the ‘collapse’ of the target ‘wave-function’ – upon its direct physical interaction with the (complimentary) probe element, which is contradicted by the (earlier demonstrated) Duality Principle’s proof for the conceptual computational inability to determine any (complimentary) ‘target’ values based on its direct (or even indirect) physical interactions with another subatomic (complimentary) ‘probe’ element. Instead, the Duality Principle asserts that all quantum (complimentary) ‘probe-target’ values may only be computed ‘a-causally’ based on the conceptually higher-ordered ‘D2’

computation of the “co-occurrences” of any hypothetical ‘probe-target’ complimentary elements... Therefore, it becomes clear that both Quantum and Relativistic theoretical models have to be reformulated based on the Duality Principle’s (proven) singular conceptually higher-ordered ‘a-causal D2’ computational framework. A key possible guiding principle in searching for such an alternative singular conceptually higher-ordered ‘D2 a-causal’ computational framework formulation of both quantum and relativistic (well-validated) empirical findings is Einstein’s dictum regarding the fate of a “good theory” (Einstein, 1916) – which can become a special case in a broader more comprehensive framework. More specifically, based on the Duality Principle’s (abovementioned) negation of the current existing quantum or relativistic theoretical interpretations of these well-validated empirical findings including: the quantum – ‘probabilistic interpretation of the uncertainty principle’ (and its corresponding probabilistic ‘wave function’), ‘particle-wave duality’ ‘quantum entanglement’, and relativistic constancy of the speed of light (and corresponding speed limit on transfer of any object or signal), there seems to arise a growing need for an alternative reformulation of each and every one of these physical phenomena (e.g., separately and conjointly) – which may “fit in” within this singular (conceptually higher-ordered) ‘D2 a-causal’ computational framework; Indeed, what follows is a ‘garland’ of those quantum or relativistic empirical findings – reformulated based upon the Duality Principle – as fitting within a singular ‘a-causal D2’ computational mechanism; In fact, it is this assembly of Duality Principle’s (motivated) theoretical reformulations of the (above) well-validated empirical dictums which will invariably lay down the foundations for the hypothetical ‘Computational Unified Field Theory’. Fortunately (as we shall witness), this piecemeal work of the assembly of all quantum and relativistic Duality Principle’s theoretically reformalized ‘garlands’ may not only lead to the discovery of such singular conceptually higher-ordered ‘D2’ Computational Unified Field Theory’ (CUFT) , but may also resolve all known (apparent) theoretical contradictions between quantum and relativistic models (as well as predict yet unknown empirical phenomena, and possibly open new theoretical frontiers in Physics and beyond)...

3.1 Single- multiple- and exhaustive- spatial-temporal measurements

Perhaps a direct ramification of the above mentioned critical difference between empirical facts and theoretical interpretation which may have a direct impact on the current (apparent) schism between Relativity Theory and Quantum Mechanics is the distinction between *single- vs. multiple- spatial-temporal* empirical measurements and its corresponding “particle” vs. “wave” theoretical constructs; It is hypothesized that if we put aside (for the time being) the ‘positivistic’ vs. ‘probabilistic’ characteristics of Relativity theory and Quantum Mechanics then we may be able to characterize *both* relativistic and quantum empirical data as representing ‘single’- vs. ‘multiple’- spatial-temporal measurements; Thus, for instance, it is suggested that a (subatomic) “particle” or (indeed) any well-localized relativistic object (or event) can be characterized as indicating a ‘single’ (localized) *spatial-temporal measurement* such that the given object or event is measured at a particular (single) spatial point {s_i} at any given temporal point {t_i}. In contrast, the “wave” characteristics of quantum mechanics represent a *multi spatial-temporal measurement* wherein there are at least *two* separate spatial-temporal measurements for each temporal point {s_i t_i , s_(i+n) t_(i+n)}.

Indeed, I hypothesize that precisely such a distinction between single- and multiple-spatial-temporal measurement (and conceptualization) may stand at the basis of some of the (apparent) quantum 'conundrums' such as the 'particle-wave duality', the 'double-slot experiment', and 'quantum entanglement'; Specifically, I suggest that if (indeed) the primary difference between the 'particle' and 'wave' characterization is *single-* vs. *multiple-* spatial-temporal measurements, then this can account for instance for the (apparently) "strange" empirical phenomena observed in the 'double-slot' experiment. This is because it may be the case wherein the opening of a *single* slot only allows for the measurement of a single spatial-temporal measurement at the interference detector surface (e.g., due to the fact that a single slot opening only allows for the measurement of the change in a single photon's impact on the screen). In contrast, opening two slots allows the interference detector surface to measure *two* spatial-temporal points simultaneously thereby revealing the 'wave' (interference) pattern. Moreover, I hypothesize that if indeed the key difference between the 'particle' and 'wave' characteristics is their respective single- vs. multiple- spatial-temporal measurements, then it may also be the case wherein any "*particle*" measurement (e.g., or for that matter also any single spatial-temporal *relativistic* measurements) is *embedded* within the broader *multi- spatial-temporal 'wave'* measurement... In this case, the current probabilistic interpretation of quantum mechanics (which has been challenged earlier by the Duality Principle) may give way to a *hierarchical-dualistic* computational interpretation which regards any 'particle' measurement as merely a localized (e.g., single spatial-temporal) segment of a broader multi spatial-temporal 'wave' measurement.

One further potentially significant computational step – e.g., beyond the 'single' spatial-temporal "particle" (or object) as potentially *embedded* within the 'multiple spatial-temporal "wave" measurement – may be to ask: is it possible for both the single spatial-temporal "particle" and the multi- spatial-temporal "wave" measurements to be embedded within a conceptually higher-ordered 'D2' computational framework?

This hypothetical question may be important as it may point the way towards a formal physical representation of the Duality Principle's asserted singular conceptually higher-ordered 'D2 a-causal computational framework': This is because the Duality Principle's assertion regarding the existence of a singular higher-ordered D2 'a-causal' computation can consist of *all single- multiple- or even the entire range of spatial pixels* '{*si...sn*}' that exist at any point/s in time {*ti ...ti*} which are *computed as "co-occurring" pairs* of 'relativistic observer – Phenomenon' or pairs of subatomic 'probe – target' elements (e.g., as computed at this singular conceptually higher-ordered 'D2' computational level); This implies that since there cannot be any "real" 'material-causal' interactions between any of these relativistic 'observer-Phenomenon' or quantum 'probe-target' pairs, then all such hypothetical 'spatial pixels' '{*si...sn*}' occurring at any hypothetical temporal point/s {*ti ...ti*} must necessarily form an exhaustive 'pool' of the entire corpus of spatial-temporal points, which according to the Duality Principle must only exist as the above mentioned quantum (subatomic) 'probe-target' or relativistic (differential) 'observer-Phenomenon' computational pairs at the singular conceptually higher-ordered 'D2 A-Causal Computational Framework'.

3.2 The 'Universal Simultaneous Computational Frames' (USCF's)

Indeed, an additional empirical support for the existence of such (hypothetical) singular conceptually higher-ordered 'D2' exhaustive pool of all "co-occurring" quantum or relativistic

pairs may be given by the well validated empirical phenomenon of 'quantum entanglement'; In a nutshell, 'quantum entanglement' refers to the finding whereby a subatomic measurement of one of two formerly connected "particles" – which may be separated (e.g. at the time of measurement) by a distance greater than a light's signal can travel can 'instantaneously' affect the measure outcome of the other (once interrelated) 'entangled' particle...

The reason that 'quantum entanglement' may further constrain the operation of higher-ordered hypothetical 'D2 A-Causal' computational framework is that it points at the existence of an empirical dictum which asserts that even in those computational instances in which two spatial-temporal events seem to be physically "separated" (e.g., by a distance greater than possibly travelled by Relativity's speed of light limit) the higher-ordered 'D2 A-Causal Computation' occurs 'instantaneously'! Therefore, this 'quantum entanglement' empirical dictum indicates that the 'D2 a-causal' computation of all spatial pixels in the universe – be carried out "at the same time", i.e., "simultaneously" at the D2 computational mechanism; In other words, the above mentioned 'D2 a-causal computation' mechanism must consist of the entirety of all possible quantum 'probe-target' or relativistic 'observer-Phenomenon' pairs occupying an exhaustive three-dimensional 'picture' of the entire corpus of all spatial pixels in the universe – for any given (minimal) 'time-point';

Therefore, if (indeed) due to the empirical-computational constraint imposed by 'quantum entanglement' we reach the conclusion wherein all spatial-pixels in the (subatomic as well relativistic) universe must necessarily exist "simultaneously" (e.g., for any minimal 'temporal point') at the 'D2 a-causal computation' level"; And based on the Duality Principle's earlier proven conceptual computational irreducibility of the determination of any quantum or relativistic relationship to within any direct or indirect *physical* interaction between any hypothetical subatomic 'probe' and 'target' elements or between any relativistic differential 'observer' and any 'Phenomenon' – but only from this singular higher-ordered 'D2 A-Causal Computational Framework';

It is hereby hypothesized that the 'D2 A-Causal Computational' processing consists of a series of '*Universal Simultaneous Computational Frames*' (USCF's) which comprise the entirety of the (quantum and relativistic) 'spatial-pixels' in the physical universe (i.e., at any given "minimal time-point")... Moreover, it is hypothesized that in order for this singular conceptually higher-ordered 'A-Causal Computational Framework' to produce all known quantum and relativistic physical phenomena there must necessarily exist a series of (extremely rapid) such '*Universal Simultaneous Computational Frames*' (USCF's) that give rise to three distinct '*Computational Dimensions*' – which include: '*Computational Framework*', '*Computational Consistency*' and '*Computational Locus*';

3.3 Computational- framework, consistency and locus

Based on the Duality Principle's asserted singular conceptually higher-ordered 'D2' computational framework comprising of an 'A-Causal-Computation' of a rapid series of '*Universal Simultaneous Computational Frames*' (USCF's) it is hypothesized that three interrelated computational dimensions arise as different computational measures relating to – the '*Framework*' of computation (e.g., relating to the entire USCF/s '*frame/s*' or to a particular '*object*' within the USCF/s), the degree of '*Consistency*' across a series of USCF's (e.g., 'consistent' vs. 'inconsistent'), and the '*Locus*' of computational measure/s (e.g., whether the computation is carried out 'locally'- from within any particular 'reference system', or 'globally'- that is, externally to a particular reference system). It is further

suggested that the combination of these three independent computational factors gives rise – not only to all relativistic and quantum basic physical features of ‘space’, ‘time’, ‘energy’, ‘mass’ etc. but may in fact exhaustively replicate, coalesce and harmonize all apparently existing theoretical contradictions between quantum and relativistic theories of physical reality...

First, the (four) basic physical features of physical reality are defined as the product of the interaction between the two Computational Dimensions of ‘*Framework*’ (‘frame’ vs. ‘object’) and ‘*Consistency*’ (‘consistent’ vs. ‘inconsistent’): thus, for instance, it is hypothesized that a computational index of the degree of ‘frame-consistent’ presentations across a series of USCF’s gives us a measure of the “spatial” value of any given object; In contrast, the computation of the degree of ‘frame-inconsistent’ measure/s of any given object – gives rise to the “energy” value (of any measured object or event). Conversely, the computational measure of the degree of ‘object-consistent’ presentations (e.g., across a series of USCF’s) produces the object’s “mass” value. In contrast, the measure of an object’s (or event’s) ‘object-inconsistent’ presentations computes that object’s/event’s temporal value... A (partial) rationale for these hypothetical computational measures may be derived from glancing at their computational “equivalences” – within the context of an analysis of the apparent physical features arising from the dynamics of a *cinematic* (two dimensional) film; A quick review of the analogous cinematic measure of (any given object’s) “spatial” or “energetic” value/s indicates that whereas a (stationary) object’s ‘spatial’ measure or a measure of the ‘spatial’ distance a moving object traverses (e.g., across a certain number of cinematic film frames) depends on the number of pixels that object occupies “consistently”, or the number of pixels that object travelled which remained constant (e.g., consistent) – across a given number of cinematic frames. Thus, the cinematic computation of ‘spatial’ distance/s is given through an analysis of the number of pixels (e.g., relative to the entire frame’s reference system) that were either traversed by an object or which that object occupies (e.g., its “spatial” dimensions); In either case, the ‘spatial value’ (e.g., of the object’s consistent dimensions or of its travelled distance) is computed based on the number of consistent pixels that object has travelled through or has occupied (across a series of cinematic frames); In contrast, an object’s “energetic” value is computed through a measure of the number of pixels that object has ‘displaced’ across a series of frames – such that its “energy” value is measured (or computed) based on the number of pixels that object has displaced (e.g., across a certain number of series of cinematic frames). Thus, an object’s ‘energy’ value can be computed as the number of ‘inconsistent’ pixels that object has displaced (across a series of frames)... Note that in both the cases of the ‘spatial’ value of an object or of its ‘energetic’ value, the computation can only be carried out with reference to the (entire- or certain segments of-) ‘frame/s’, since we have to ascertain the number of ‘consistent’ or ‘inconsistent’ pixels (e.g., relative to the reference system of the entire- or segments of- frame/s);

In contrast, it is suggested that the analogous cinematic measures of “mass” and “time” – involve a computation of the number of “object-related” (i.e., in contrast to the abovementioned “frame-related”) “consistent” vs. “inconsistent” presentations; Thus, for instance, a special cinematic condition can be created in which any given object can be presented at- or below- or above- a certain ‘psychophysical threshold’ – i.e., such that the “appearance” or “disappearance” of any given object critically depends on the number of times that object is presented ‘consistently’ (across a certain series of cinematic frames); Such psychophysical-object cinematic condition necessarily produces a situation in which

the number of consistent-object presentations (across a series of frames) determines whether or not that object will be perceived to "exist" or "not exist"; Indeed, a further extension of the same precise psychophysical cinematic scenario can produce a condition in which there is a direct correlation between the number of times an object is presented 'consistently' (across a given series of cinematic frames) and its perceived "mass": Thus, whereas the given object - would seem to "not exist" below a certain number of presentation (out of a given number of frames), and would begin to "exist" once its number of presentations exceeds the particular psychophysical threshold, then it follows that a further increase in the number of presentations (e.g., out of a given number of frames) will increase that object's perceived "mass"... Perhaps somewhat less 'intuitive' is the cinematic computational equivalence of "time" - which is computed as the number of 'object-related' "inconsistent" presentations; It's a well-known fact that when viewing a cinematic film, if the rate of projection is slowed down ("slow-motion") the sense of time is significantly 'slowed-down'... This is due to the fact that there is much less changes taking place relative to the object/s of interest that we are focusing on... Indeed, it is a scientifically validated fact that our perception of time depends (among other factors) on the number of stimuli being presented to us (within a given time-interval, called the '*filled-duration*' illusion). Therefore, it is suggested that the cinematic computation (equivalence) of "time" is derived from the number of 'object-related *inconsistent*' presentations (across a given number of cinematic frames); the greater the number of object-related inconsistent presentations the more time has elapsed - i.e., as becomes apparent in the case of 'slow-motion' (e.g., in which the number of object-related inconsistent presentations are small and in which very little 'time' seems to elapse) as opposed to 'fast-motion' (e.g., in which the number of object-related inconsistent presentations is larger and subsequently a significant 'time' period seems to pass)...

Obviously, there are significant differences between the two dimensional cinematic metaphor and the hypothetical Computational Unified Field Theory's postulated rapid series of three-dimensional 'Universal Simultaneous Computational Frames' (USCF's); Thus, for instance, apart from the existence of *two-dimensional* vs. *three dimensional* frames, various factors such as: the (differing) rate of projection, the universal simultaneous computation (e.g., across the entire scope of the physical universe) and other factors (which will be delineated below). Nevertheless, utilizing at least certain (relevant) aspects of the cinematic film metaphor may still assist us in better understanding some the potential dynamics of the USCF's rapid series; Hence, it is suggested that we can perhaps learn from the (above mentioned) 'object' vs. 'frame' and 'consistent' vs. 'inconsistent' computational features characterizing the cinematic equivalents of "space" ('frame-consistent'), "energy" ('frame-inconsistent'), "mass" ('object-consistent') and "time" ('object-inconsistent') - with reference to the CUFT's hypothesized two (abovementioned) Computational Dimensions of 'Computational Framework' (e.g., 'frame' vs. 'object') and 'Computational Consistency' (e.g., 'consistent' vs. 'inconsistent'). The third (and final) hypothesized computational dimension of 'Computational Locus' does not correlate with the cinematic metaphor but can be understood when taking certain aspects of the cinematic metaphor and combining them with certain known features of Relativity theory; As outlined (earlier), this third 'Computational Locus' dimension refers to the particular frame of reference from which any of the two other Computational Dimensions (e.g., 'Framework' or 'Consistency') are being measured: Thus, for instance, it is suggested that the measurement of any of the abovementioned (four) basic physical features of

'space' ('frame-consistent'), 'energy' (frame-inconsistent), 'mass' ('object-consistent') and 'time' ('object-inconsistent') – can be computed from *within* the 'local' frame of reference of the particular object (or observer) being measured, or from an external 'global' frame of reference (e.g., which is different than that of the particular object or observer).

4. The 'Computational Unified Field Theory' (CUFT)

Based on the abovementioned three basic postulates of the 'Duality Principle' (e.g., including the existence of a conceptually higher-ordered 'D2 A-Causal' Computational framework), the existence of a rapid series of 'Universal Simultaneous Computational Frames' (USCF's) and their accompanying three Computational Dimensions of – 'Framework' ('frame' vs. 'object'), 'Consistency' ('consistent' vs. 'inconsistent') and 'Locus' ('global' vs. 'local') a (novel) 'Computational Unified Field Theory' (CUFT) is hypothesized (and delineated);

First, in order to fully outline the theoretical framework of this (new) hypothetical CUFT let us try to closely follow the (abovementioned) 'cinematic-film' metaphor (e.g., while keeping in mind the earlier mentioned limitations of such an analogy in the more complicated three dimensional universal case of the CUFT): It is hypothesized that in the same manner that a cinematic film consists of a series of (rapid) 'still-frames' which produce an 'illusion' of objects (and phenomena) being displaced in 'space', 'time', possessing an apparent 'mass' and 'energy' values – the CUFT's hypothesized rapid series of 'Universal Simultaneous Computational Frames' (USCF's) gives rise to the apparent 'physical' features of 'space', 'time', 'energy' and 'mass'... It is further hypothesized that (following the cinematic-film analogy) the minimal (possible) degree of 'change' across any two (subsequent) 'Universal Simultaneous Computational Frames' (USCF's) is given by Planck's 'h' constant (e.g., for the various physical features of 'space', 'time', 'energy' or 'mass')... Likewise the maximal degree of (possible) change across two such (subsequent) USCF's may be given by: 'c²'; Note that both of these (quantum and relativistic) computational constraints – arising from the 'mechanics' of the rapid (hypothetical) series of USCF's – exist as basic computational characteristics of the conceptually higher-ordered 'D2' (a-causal) computational framework, rather than exist as part of the 'di1' physical interaction (apparently) taking place within any (single or multiple) USCF's... Indeed, it is further hypothesized that a measure of the actual rate of presentation (or computation) of the series of USCF's may be given precisely through the product of these ('D2') computational constraints of the maximal degree of (inter-frame) change/s ('c²') divided by the minimal degree of (inter-frame) change/s ('h'): 'c²'/'h'!

Specifically, the CUFT hypothesizes that the computational measures of 'space', 'energy', 'mass' and 'time' (and "causation") are derived based on an 'object' vs. 'frame' and 'consistent' vs. 'inconsistent' computational combinations;

Thus, it is hypothesized that the 'space' measure of an object (e.g., whether it is the spatial dimensions of an object or event of whether it relates to the spatial location of an object) is computed based on the number of 'frame-consistent' (i.e., cross-USCF's constant points or "universal-pixels") which that object possesses across subsequent USCF's, divided by Planck's constant 'h' which is multiplied by the number of USCF's across which the object's spatial values have been measured.

$$S: (fi\{x,y,z\}[USCF(i)] + \dots fj\{x,y,z\}[USCF(n)]) / h \times n\{USCF's\}$$

such that:

$$fj\{x,y,z\}[USCF(i)] \leq fi\{x+(hxn),y+(hxn),z+(hxn)\}[USCF(i...n)]$$

where the 'space' measure of a given object (or event) is computed based on a *frame consistent* computation that adds the specific USCF's (x,y,z) localization across a series of USCF's [1...n] - which nevertheless do *not exceed* the threshold of Planck's constant per each ('n') number of frames (e.g., thereby providing the CUFT's definition of "space" as 'frame-consistent' USCF's measure).

Conversely, the 'energy' of an object (e.g., whether it is the spatial dimensions of an object or event or whether it relates to the spatial location of an object) is computed based on the *frame's differences* of a given object's location/s or size/s across a series of USCF's, divided by the speed of light 'c' multiplied by the number of USCF's across which the object's energy value has been measured:

$$E: (fj\{x,y,z\} [USCF(n)] - (fi\{(x+n),(y+n),(z+n)\} [USCF(i...n)])) / c \times n\{USCF's\}$$

such that:

$$fj\{x,y,z\} [USCF(n)] > (fi\{x+(hxn),y+(hxn),z+(hxn)\} [USCF(i...n)])$$

wherein the energetic value of a given object, event etc. is computed based on the subtraction of that object's "universal pixels" location/s across a series of USCF's, divided by the speed of light multiplied by the number of USCF's.

In contrast, the of 'mass' of an object is computed based on a measure of the number of times an 'object' is presented '*consistently*' across a series of USCF's, divided by Planck's constant (e.g., representing the minimal degree of inter-frame's changes):

$$M: \sum[o_j\{x,y,z\} [USCF(n)] = o(i...j-1)\{(x),(y),(z)\} \{USCF(i...n)\} / h \times n\{USCF's\} \\ \{USCF(1...n)\} / h \times n\{USCF's\}$$

where the measure of 'mass' is computed based on a comparison of the number of instances in which an object's (or event's) 'universal-pixels' measures (e.g., along the three axes 'x', 'y' and 'z') is identical across a series of USCF's (e.g., $\sum o_i\{x,y,z\} [USCF(n)] = o_j\{(x+m),(y+m),(z+m)\} [USCF(1...n)]$), divided by Planck's constant.

Again, the measure of 'mass' represents an *object-consistent* computational measure - e.g., regardless of any changes in that object's spatial (frame) position across these frames.

Finally, the 'time' measure is computed based on an '*object-inconsistent*' computation of the number of instances in which an 'object' (i.e., corresponding to only a particular segment of the entire USCF) changes across two subsequent USCF's (e.g., $\sum o_i\{x,y,z\} [USCF(n)] \neq o_j\{(x+m),(y+m),(z+m)\} [USCF(1...n)]$), divided by 'c':

$$T: \sum o_j\{x,y,z\} [USCF(n)] \neq o(i...j-1)\{(x),(y),(z)\} [USCF(1...n)] / c \times n\{USCF's\}$$

such that:

$$T: \sum o_i\{x,y,z\}[USCF(n)] - o_j\{(x+m),(y+m),(z+m)\} [USCF(1...n)] \leq c \times n\{USCF's\}$$

Hence, the measure of 'time' represents a computational measure of the number of '*object-inconsistent*' presentations any given object (or event) possesses across subsequent USCF' (e.g., once again- regardless of any changes in that object's 'frame's' spatial position across this series of USCF's).

Interestingly, the concept of “causality” – when viewed from the perspective of the (above mentioned) ‘D2 A-Causal Computation’ (rapid) series of USCF’s replaces the (apparent) ‘di1’ “material-causal” physical relationship/s between any given ‘x’ and ‘y’ objects, factors, or phenomenon – through the existence of *apparent* (quantum or relativistic) spatial-temporal or energy-mass relationships across a series of USCF’s; Thus, for instance, according to the CUFT’s higher-ordered ‘D2 A-Causal Computation’ theoretical interpretation (e.g., as well as based on the earlier outlined ‘Duality Principle’ proof) in both the relativistic (assumed SROCS) direct physical interaction (‘di1’) between any hypothetical (differential) relativistic observer and any (corresponding) spatial-temporal or energy-mass ‘Phenomenon’, and in the quantum (assumed SROCS) direct physical interaction (‘di1’) between any subatomic ‘probe’ particle and any possible ‘target’ element –there *does not exist* any ‘direct’ (‘di1’) *material-causal* relationship/s between the relativistic observer and (measured) Phenomenon, or between the quantum subatomic ‘probe’ and ‘target’ entities which results in the determination of the particular spatial-temporal value of any given Phenomenon (e.g., for a particular differential observer) or the ‘collapse’ of the (assumed) probability wave function which results in the selection of only one (complimentary) spatial-energetic or temporal-mass target value... Instead, according to the CUFT’s stipulated conceptually higher-ordered singular (quantum and relativistic) D2 A-Causal Computational Framework these apparently ‘material-causal’ subatomic probe-target or relativistic differential observer-Phenomenon pair/s are in fact replaced by A hypothetical ‘*Universal Computational Principle*’ (“”) D2 A-Causal Computation of the ‘co-occurrence’ of a particular set of such relativistic ‘observer-Phenomenon’ or quantum subatomic ‘probe-target’ pairs (e.g., appearing across a series of USCF’s!) Indeed, a thorough understanding of the CUFT’s replacement of any (hypothetical quantum or relativistic) ‘material-causal’ relationship/s with the conceptually higher-ordered (singular) ‘D2 A-Causal Computation’ (“”), which simply co-presents a series of particular relativistic ‘observer-Phenomenon’ or subatomic ‘probe-target’ pairs across the series of given USCF’s may also open the door for a fuller appreciation of the lack of any (continuous) “physical” or “material” relativistic or quantum object’s, event/s or phenomena etc. “in-between” USCF’s frames – except for the (above mentioned) ‘Universal Computational Principle’ (“’ - at ‘D2’). In other words, when viewed from the perspective of the CUFT’s conceptually higher-ordered (singular) ‘’ computational stance of the series of (rapid) USCF’s all of the known quantum and relativistic phenomena (and laws) of ‘space’, ‘time’, energy’, ‘mass’ and ‘causality’, ‘space-time’, ‘energy-mass’ equivalence, ‘quantum entanglement’, ‘particle-wave duality’, “collapse” of the ‘probability wave function’ etc. phenomena – are replaced by an ‘a-causal’ (D2) computational account (which will be explicated below);

4.1 The CUFT’s replication of quantum & relativistic findings

As sown above, the Computational Unified Field Theory postulates that the various combinations of the ‘Framework’ and ‘Consistency’ computational dimensions produce the known ‘physical’ features of: ‘space’ (‘frame-consistent’), ‘energy’ (‘frame-inconsistent’), ‘mass’ (‘object-consistent’) and ‘time’ (‘object-inconsistent’). The next step is to explicate the various possible relationships that exists between each of these four basic ‘physical’ features and the two levels of the third Computational Dimension of ‘Locus’ – e.g., ‘global’ vs. ‘local’: It is suggested that each of these four basic physical features can be measured either from

the computational framework of the entire USCF's perspective (e.g., a 'global' framework) or from the computational perspective of a particular segment of those USCF's (e.g., 'local' framework). Thus, for instance, the spatial features of any given object can be measured from the computational perspective of the (series of the) entire USCF's, or it can be measured from the computational perspective of only a segment of those USCF's - i.e., such as from the perspective of that object itself (or from the perspective of another object travelling alongside- or in some other specific relationship- to that object). In much the same manner all other (three) physical features of 'energy', 'mass' and 'time' (e.g., of any given object) can be measured from the 'global' computational perspective of the entire (series of) USCF's or from a 'local' computational perspective of only a particular USCF's segment (e.g., of that object's perspective or of another travelling frame of reference perspective). One possible way of formalizing these two different 'global' vs. 'local' computational perspectives (e.g., for each of the four abovementioned basic physical features) is through attaching a 'global' {'g'} vs. 'local' {'l'} subscript to each of the two possible (e.g., 'global' vs. 'local') measurements of the four physical features. Thus, for instance, in the case of 'mass' the 'global' (computational) perspective measures the number of times that a given object has been presented consistently (i.e., unchanged)- when measured across the (entire) USCF's pixels (e.g., across a series of USCF's) ; In contrast, the 'local' computational perspective of 'mass' measures the number of times that a given object has been presented consistently (e.g., unchanged) when measured from within that object's frame of reference;

$$M(g): \sum [oj\{x,y,z\}(g) [USCF(n)] = o(i...j-1)\{(x),(y),(z)\} (g) \{USCF(i...n)\} / h \times n\{USCF's\}$$

such that

$$[oi\{x,y,z\}USCF(n)] - [oi\{(x+j),(y+j),(z+j)\}USCF(1...n)] \leq n \times h[USCF(1...n)].$$

$$M(l): \sum [oj\{x,y,z\}(l) [USCF(n)] = o(i...j-1)\{(x),(y),(z)\} (l) \{USCF(i...n)\} / h \times n\{USCF's\}$$

such that

$$[oi\{x,y,z\}USCF(n)] - [oi\{(x+j),(y+j),(z+j)\}USCF(1...n)] \leq n \times h[USCF(1...n)].$$

What is to be noted is that these (hypothesized) different measurements of the 'global' vs. local' computational perspectives - i.e., as measured externally to a particular object's pixels ('global') as opposed to only the pixels constituting the particular segment of the USCFs which comprises the given object (or frame of reference) may in fact replicate Relativity's known phenomenon of the increase in an object's mass associated with a (relativistic) increase in its velocity (e.g., as well as all other relativistic phenomena of the dilation in time, shrinkage of length etc.); This is due to the fact that the 'global' measurement of an object's mass critically depends on the *number of times* that object has been presented (consistently) across a series of USCF's: e.g., the greater the number of (consistent) presentations the higher its mass. However, since the computational measure of 'mass' is computed relative to Planck's ('h') constant (e.g., computed as a given object's number of consistent presentations across a specific number of USCF's frames); and since the spatial measure of any such object is contingent upon that object's consistent presentations (across the series of USCF's) such that the object does not differ ('spatially') across frames by more than the number of USCF's multiplied by Planck's constant; then it follows that the higher an object's energy - i.e., displacement of pixels across a series of USCF's, the greater number of pixels that object has

travelled and also the greater number of times that object has been presented across the series of USCF's – which constitutes that object's 'global' mass measure! In other words, when an object's mass is measured from the 'global' perspective we obtain a measure of that object's (number of external) global pixels (reference) which increases as its relativistic velocity increases, thereby also increasing the number of times that object is presented (e.g., from the global perspective) hence increasing its globally measured 'mass' value. In contrast, when that object's mass is measured from the 'local' computational perspective – such 'local mass' measurement only takes into account the number of times that object has been presented (across a given series of USCF's) as measured from within that object's frame of reference; Therefore, even when an object increases its velocity – if we set to measure its mass from within its own frame of reference we will not be able to measure any increase in its measured 'mass' (e.g., since when measured from within its local frame of reference there is no change in the number of times that object has been presented across the series of USCF's)...

Likewise, it is hypothesized that if we apply the 'global' vs. 'local' computational measures to the physical features of 'space', 'energy' and 'time' we will also replicate the well-known relativistic findings of the shortening of an object's length (in the direction of its travelling), and the dilation of time (as measured by a 'global' observer): Thus, for instance, it is suggested that an application of the same 'global' computational perspective to the physical feature of 'space' brings about an inevitable shortening of its spatial length (e.g., in the direction of its travelling):

$$S(g): (f_{i\{x,y,z\}}(g) [\text{USCF}(i)] + \dots f_{j\{x,y,z\}}(g) [\text{USCF}(n)]) / h \times n\{\text{USCF}'s\}$$

such that:

$$f_{j\{x,y,z\}}(g) [\text{USCF}(i)] \leq f_{i\{x+(hxn),y+(hxn),z+(hxn)\}}(g) [\text{USCF}(i\dots n)]$$

It is hypothesized that this is due to the global computational definition of an object's spatial dimensions which computes a given object's spatial (length) based on its consistent 'spatial' pixels (across a series of USCF's) – such that any changes in that object's spatial dimensions must not exceed Planck's ('h') spatial constant multiplied by the number of USCF's; This is because given such Planck's minimal 'spatial threshold' computational constraint – the faster a given relativistic object travels (e.g., from a global computational perspective) the less 'consistent' spatial 'pixels' that object possesses across frames which implies the shorter its spatial dimensions become (i.e., in the direction of its travelling); in contrast, measured from a 'local' computational perspective there is obviously no such "shrinkage" in an object's spatial dimensions – since based on such a 'local' perspective all of the spatial 'pixels' comprising a given object remain unchanged across the series of USCF's.

$$S \{l'\}: (f_{i\{x,y,z\}}\{l'\} [\text{USCF}(i)] + \dots f_{j\{x,y,z\}}\{l'\} [\text{USCF}(n)]) / h \times n\{\text{USCF}'s\}$$

such that:

$$f_{j\{x,y,z\}}\{l'\} [\text{USCF}(i)] \leq f_{i\{x+(hxn),y+(hxn),z+(hxn)\}}\{l'\} [\text{USCF}(i\dots n)]$$

Somewhat similar is the case of the 'global' computation of the physical feature of 'time' which is computed based on the number of measured changes in the object's spatial 'pixels' constitution (across frames):

$$T_g : \sum o_i\{x,y,z\}[\text{USCF}(n)] \neq o_j\{(x+m),(y+m),(z+m)\} [\text{USCF}(1\dots n)] / c \times n\{\text{USCF's}\},$$

such that:

$$T : \sum o_i\{x,y,z\}[\text{USCF}(n)] - o_j\{(x+m),(y+m),(z+m)\} [\text{USCF}(1\dots n)] \leq c \times n\{\text{USCF's}\}$$

The temporal value of an event (or object) is computed based on the number of times that a given object or event has changed - relative to the speed of light (e.g., across a certain number of USCF's); However, the *measurement* of temporal changes (e.g., taking place at an object or event) differ significantly - when computed from the 'global' or 'local' perspectives: This is because from a 'global' perspective, the faster an object travels (e.g., relative to the speed of light) the less potential changes are exhibited in that object's or event's presentations (across the relevant series of USCF's). In contrast, from a 'local' perspective, there is no change in the number of measured changes in the given object (e.g., as its velocity increases relative to the speed of light) - since the local (computational) perspective does not encompass globally measured changes in the object's displacement (relative to the speed of light)...

Note also that we can begin appreciating the fact that from the CUFT's (D2 USCF's) computational perspective there seems to be inexorable (computational) interrelationships that exist between the eight computational products of the three postulated Computational Dimensions of 'Framework', 'Consistency' and 'Locus'; Thus, for instance, we find that an acceleration in an object's velocity increases the number of times that object is presented (e.g., 'globally' across a given number of USCF frames) - which in turn also increases its 'mass' (e.g., from the 'global Locus' computational perspective), and (inevitably) also decreases its (global) 'temporal' value (due to the decreased number of instances that that object changes across those given number of frames (e.g., globally- relative to the speed of light maximal change computational constraint)... Indeed, over and beyond the hypothesized capacity of the CUFT to replicate and account for all known relativistic and quantum empirical findings, its conceptually higher-ordered 'D2' USCF's emerging computational framework may point at the unification of all apparently "distinct" physical features of 'space', 'time', 'energy' and 'mass' (and 'causality') as well as a complete harmonization between the (apparently disparate) quantum (microscopic) and relativistic (macroscopic) phenomena and laws; the apparent disparity between quantum (microscopic) and relativistic (macroscopic) phenomena and laws;

Towards that end, we next consider the applicability of the CUFT to known quantum empirical findings: Specifically, we consider the CUFT's account of the quantum (computational) complimentary properties of 'space' and 'energy' or 'time' and 'mass'; of an alternative CUFT's account of the "collapse" of the probability wave function; and of the 'quantum entanglement' and 'particle-wave duality' subatomic phenomena; It is also hypothesized that these alternative CUFT's theoretical accounts may also pave the way for the (long-sought for) unification of quantum and relativistic models of physical reality. First, it is suggested that the quantum complimentary 'physical' features of 'space' and 'energy', 'time' and 'mass' - may be due to a 'computational exhaustiveness' (or 'complimentarity') of each of the (two) levels of the Computational Dimension of 'Framework'. It is hypothesized that both the 'frame' and 'object' ('D2-USCF's') computational perspectives are *exhaustively* comprised of their 'consistent' (e.g., 'space' and 'energy', or 'mass' and 'time' physical features, respectively): Thus, whether we chose to examine the USCF's (D2) computation of

a 'frame' – which is exhaustively comprised of its 'space' ('consistent') and 'energy' ('inconsistent') computational perspectives or if we chose to examine the 'object' perspective of the USCF's (D2) series – which is exhaustively comprised of its 'mass' ('consistent') and 'time' (inconsistent) computational aspects: in both cases the (D2) USCF's series is exhaustively comprised of these 'consistent' and 'inconsistent' computational aspects (e.g., of the 'frame' or 'object' perspectives)...

This means that the computational definitions of each of these pairs of 'frame': 'space' (consistent) and 'energy' (inconsistent) or 'object': 'mass' (consistent) or 'time' (inconsistent) is 'exhaustive' in its comprising of the USCF's Framework (i.e., 'frame' or 'object') Dimension:

Indeed, note that the computational definitions of 'space' and 'energy' exhaustively define the USCF's (D2) Framework computational perspective of a 'frame':

$$S: [fi\{x,y,z\}[USCF(n)] + fj\{x,y,z\}[USCF(1...n)]] / h \times n\{USCF's\},$$

such that:

$$fi\{x,y,z\}[USCF(n)] \leq fj\{x+(hxn),y+(hxn),z+(hxn)\}[USCF(1...n)];$$

and

$$E: (fi\{x,y,z\}[USCF(n)] - (fj\{(x+m),(y+m),(z+m)\}[USCF(1...n)])) / c \times n\{USCF's\}$$

such that:

$$fi\{x,y,z\}[USCF(n)] > (fj\{x+(hxn),y+(hxn),z+(hxn)\}[USCF(n)])$$

Likewise, note that the computational definitions of 'mass' and 'time' exhaustively define the USCF's (D2) Framework computational perspective of an 'object':

$$M: \sum [oi\{x,y,z\}USCF(n)] = [oi\{(x+j),(y+j),(z+j)\} USCF(1...n)] / h \times n\{USCF's\}$$

such that

$$[oi\{x,y,z\}USCF(n)] - [oi\{(x+j),(y+j),(z+j)\}USCF(1...n)] \leq n \times h[USCF(1...n)].$$

and

$$T: \sum oi\{x,y,z\}[USCF(n)] \neq oj\{(x+m),(y+m),(z+m)\} [USCF(1...n)] / c \times n\{USCF's\}$$

such that:

$$T: \sum oi\{x,y,z\}[USCF(n)] - oj\{(x+m),(y+m),(z+m)\} [USCF(1...n)] \leq c \times n\{USCF's\}$$

Thus, it is hypothesized that it is the *computational exhaustiveness* of the Framework Computational Dimension's (two) levels (e.g., of 'frame' or 'object' perspectives) which gives rise to the known quantum complimentary 'physical' features of 'space' and 'energy' (e.g., the *frame's* 'consistent' and 'inconsistent' perspectives) or of 'mass' and 'time' (e.g., the *object's* 'consistent' and 'inconsistent' perspectives). However, since this hypothetical 'computational exhaustiveness' of the Framework Dimension's (two) levels arises as an integral part of the USCF's (D2) Universal Computational Principle's operation – it manifests through both the (above mentioned) computational definitions of 'space' and

'energy', 'mass' and 'time', as well as through a singular 'Universal Computational Formula', postulated below:

4.2 The 'Universal Computational Formula'

Based on the abovementioned three basic postulates of the 'Duality Principle' (e.g., including the existence of a conceptually higher-ordered 'D2 A-Causal' Computational framework), the existence of a rapid series of 'Universal Simultaneous Computational Frames' (USCF's - e.g., which are postulated to be computed at an incredible rate of ' c^2/h ') and their accompanying three Computational Dimensions of - 'Framework' ('frame' vs. 'object'), 'Consistency' ('consistent' vs. 'inconsistent') and 'Locus' ('global' vs. 'local') a singular 'Universal Computational Formula' is postulated which may underlie all (known) quantum and relativistic phenomena:

$$\frac{c^2x'}{h} = \frac{s}{t} \times \frac{e}{m}$$

wherein the left side of this singular hypothetical Universal Computational Formula represents the (abovementioned) universal rate of computation by the hypothetical Universal Computational Principle, whereas the right side of this Universal Computational Formula represents the 'integrative-complimentary' relationships between the four basic physical features of 'space' (s), 'time' (t), 'energy' (e) and 'mass' (m), e.g., as comprising different computational combinations of the three (abovementioned) Computational Dimensions of 'Framework', 'Consistency' and 'Locus';

Note that on both sides of this Universal Computational Formula there is a coalescing of the basic quantum and relativistic computational elements - such that the rate of Universal Computation is given by the product of the maximal degree of (inter-USCF's relativistic) change ' c^2 ' divided by the minimal degree of (inter-USCF's quantum) change ' h '; Likewise, the right side of this Universal Computational Formula meshes together both quantum and relativistic computational relationships - such that it combines between the relativistic products of space and time (s/t) and energy-mass (e/m) together with the quantum (computational) complimentary relationship between 'space' and 'energy', and 'time' and 'mass';

More specifically, this hypothetical Universal Computational Formula fully integrates between two sets of (quantum and relativistic) computations which can be expressed through two of its derivations:

$$\frac{s}{t} = \frac{m}{e} \times \left(\frac{c^2x'}{h} \right)$$

$$t \times m \times \left(\frac{c^2x'}{h} \right) = s \times e$$

The first amongst these equations indicates that there is a computational equivalence between the (relativistic) relationships of 'space and time' and 'energy and mass'; specifically, that the computational ratio of 'space' (e.g., which according to the CUFT is a measure of the 'frame-consistent' feature) and 'time' (e.g., which is a measure of the 'object-

inconsistent' feature) is equivalent to the computational ratio of 'mass' (e.g., a measure of the 'object-consistent' feature) and 'energy' (e.g., 'frame-inconsistent' feature)... Interestingly, this (first) derivation of the CUFT's Universal Computational Formula incorporates (and broadens) key (known) relativistic laws – such as (for instance) the 'E=Mc²' equation, as well as the basic concepts of 'space-time' and its curvature by the 'mass' of an object (which in turn also affects that object's movement – i.e. 'energy').

The second equation explicates the (above mentioned) quantum 'computational exhaustiveness' (or 'complimentary') of the Computational Framework Dimension's two levels of 'frame': 'space' ('consistent') and 'energy' ('inconsistent') and of 'object': 'mass' ('consistent') and 'time' ('inconsistent') 'physical' features, as part of the singular integrated (quantum and relativistic) Universal Computational Formula...

5. Unification of quantum and relativistic models of physical reality

Thus, the three (abovementioned) postulates of the 'Duality Principle', the existence of a rapid series of 'Universal Simultaneous Computational Frames' (USCF's – computed by the 'Universal Computational Principle' {''}) at the incredible hypothetical rate of 'c²/h'), and the three Computational Dimensions of 'Framework', 'Consistency' and 'Locus' have resulted in the formulation of the (hypothetical) new 'Universal Computational Formula':

$$\frac{c^2 x'}{h} = \frac{s \times e}{t m}$$

It is (finally) suggested that this (novel) CUFT and (embedded) Universal Computational Formula can offer a satisfactory harmonization of the existing quantum and relativistic models of physical reality, e.g., precisely through their integration within the (above) broader higher-ordered singular 'D2' Universal Computational Formula;

In a nutshell, it is suggested that this Universal Computational Formula embodies the singular higher-ordered 'D2' series of (rapid) USCF's, thereby integrating quantum and relativistic effects (laws and phenomena) and resolving any apparent 'discrepancies' or 'incongruities' between these two apparently distinct theoretical models of physical reality:

Therefore, it is suggested that the three (above mentioned apparent) principle differences between quantum and relativistic theories, namely: '*probabilistic*' vs. '*positivistic*' models of physical reality, '*simultaneous-entanglement*' vs. '*non-simultaneous causality*' and '*single-*' vs. '*multiple-*' *spatial-temporal modeling* can be explained (in a satisfactory manner) based on the new (hypothetical) CUFT model (represented by the Universal Computational Formula);

As suggested earlier, the apparent 'probabilistic' characteristics of quantum mechanics, e.g., wherein an (apparent) multi spatial-temporal "probability wave function" 'collapses' upon its assumed 'SROCS' direct ('di1') physical interaction with another 'probe' element is replaced by the CUFT's hypothesized (singular) conceptually higher-ordered 'D2's' rapid series of USCF's (e.g., governed by the above Universal Computational Formula); Specifically, the Duality Principle's conceptual proof for the principle inability of the SROCS computational structure to compute the "collapse" of (an assumed) "probability wave function" ('target' element) based on its direct physical interaction (at 'di1') with another 'probe' measuring element has led to a reformalization of the various subatomic quantum

effects, including: the “collapse” of the “probability wave function”, the “particle-wave duality”, the “Uncertainty Principle’s” computational complimentary features, and “quantum entanglement” as arising from the (singular higher-ordered 'D2') rapid USCF's series:

Thus, instead of Quantum theory's (currently assumed) “collapse” of the ‘probability wave function’, the CUFT posits that there exists a rapid series of ‘Universal Simultaneous Computational Frames’ (USCF's) that can be looked at from a ‘single’ spatial-temporal perspective (e.g., subatomic ‘particle’ or relativistic well localized ‘object’ or ‘event’) or from a ‘multiple’ spatial-temporal perspective (e.g., subatomic ‘wave’ measurement or conceptualization). Moreover, the CUFT hypothesizes that both the subatomic ‘single spatial-temporal’ “particle” and ‘multiple spatial-temporal’ “wave” measurements are embedded within an exhaustive series of ‘Universal Computational Simultaneous Frames’ (USCF's) (e.g., that are governed by the above mentioned Universal Computational Formula). In this way, it is suggested that the CUFT is able to resolve all three abovementioned (apparent) conceptual differences between quantum and relativistic models of the physical reality: This is because instead of the ‘collapse’ of the assumed ‘quantum probability wave function’ through its (SROCS based) direct physical interaction with another subatomic probe element, the CUFT posits the existence of the rapid series of USCF's that can give rise to ‘single-spatial temporal’ (subatomic “particle” or relativistic ‘object’ or ‘event’) or to ‘multiple spatial-temporal’ (subatomic or relativistic) “wave” phenomenon; Hence, instead of the current “probabilistic-quantum” vs. “positivistic-relativistic” (apparently disparate) theoretical models, the CUFT coalesces both quantum and relativistic theoretical models as constituting integral elements within a singular rapid series of USCF's. Thereby, the CUFT can explain all of the (apparently incongruent) quantum and relativistic phenomena (and laws) such as for instance, the (abovementioned) ‘particle’ vs. ‘wave’ and ‘quantum entanglement’ phenomena – e.g., which is essentially a representation of the fact that all single- multiple- (or exhaustive) measurements are embedded within the series of ‘Universal *Simultaneous* Computational Frames’ (USCF's) and therefore that two apparently “distinct” ‘single spatial-temporal’ measured “particles” that are embedded within the ‘multiple spatial-temporal’ “wave” measurement necessarily constitute integral parts of the same singular simultaneous USCF's (which therefore give rise to the apparent ‘quantum entanglement’ phenomenon). Nevertheless, due to the above mentioned ‘computational exhaustiveness’ (or ‘complimentarity’) the computation of such apparently ‘distinct’ “particles” embedded within the same “wave” and USCF's (series) leads to the known quantum (‘uncertainty principle’s’) complimentary computational (e.g., simultaneous) constraints applying to the measurement of ‘space’ and ‘energy’ (e.g., ‘frame’: consistent vs. inconsistent features), or of ‘mass’ ad ‘time’ (e.g., ‘object’: consistent vs. inconsistent features). Such USCF's based theoretical account for the empirically validated “quantum entanglement” natural phenomena is also capable of resolving the apparent contradictions that seems to exist between such “simultaneous action at a distance” (to quote Einstein’s famous objection) and Relativity’s constraint set upon the transmission of any signal at a velocity that exceeds the speed of light: this is due to the fact that while the CUFT postulates that the “entangled particles” are computed simultaneously (along with the entire physical universe) as part of the same USCF/s (e.g., and more specifically of the same multi spatial-temporal “wave” pattern).

Another important aspect of this (hypothetical) Universal Computational Formula’s representation of the CUFT may be its capacity to replicate Relativity’s curvature of ‘space-

time' based on the existence of certain massive objects (which in turn also affects their own space-time pathway etc.): Interestingly, the CUFT points at the existence of USCF's regions that may constitute: "high-space, high-time; high-mass, low-energy" vs. other regions which may be characterized as: "low-space, low-time; low-mass, high-energy" based on the computational features embedded within the CUFT (and its representation by the above Universal Computational Formula). This is based on the Universal Computational Formula's (integrated) representation of the CUFT's basic computational definitions 'space', 'time', 'energy' and 'mass' as:

$$\frac{s}{t} = \frac{m}{e} \times \left(\frac{c^2 x'}{h} \right)$$

which represents: 'space' - as the number of (accumulated) USCF's 'consistent-frame' pixels that any given object occupies and its (converse) computational definition of 'time' as the number of 'inconsistent-object' pixels; and likewise the computational definition of 'mass' - as the number of 'consistent-object' USCF's pixels and of 'energy' - as the (computational) definition of 'mass' as the number of 'inconsistent-frame' USCF's pixels.

Hence, General Relativity may represent a 'special case' embedded within the CUFT's Universal Computational Formula integrated relationships between 'space', 'time', 'energy' and 'mass' (computational definitions): This is because General Relativity describes the specific dynamics between the "mass" of relativistic objects (e.g., a 'global-object-consistent' computational measure), their curvature of "space-time" (i.e., based on an 'frame-consistent' vs. 'object-inconsistent' computational measures) and its relationship to the 'energy-mass' equivalence (e.g., reflecting a 'frame-inconsistent' - 'object-consistent' computational measures); This is because from the (above mentioned) 'global' computational measurement perspective there seems to exist those USCF's regions which are displaced significantly across frames (e.g., possess a high 'global-inconsistent-frame' energy value) - and therefore also exhibit increased 'global-object-consistent' mass value, and moreover are necessarily characterized by their (apparent) curvature of 'space-time' (i.e., alteration of the 'global-frame-consistent' space values and associated 'global-object-inconsistent' time values)...

Therefore, in the special CUFT's case described by General Relativity we obtain those "massive" objects, i.e., which arise from high 'global-frame-inconsistent' energy values (e.g., which are therefore presented many times consistently across frames - yielding a high 'global-object-consistent' mass value); These objects also produce low (dilated) global temporal values since the high 'global-object-consistent' (mass) value is inevitably linked with a low 'global-object-inconsistent' (time) value; Finally, such a high 'global-frame-inconsistent' (energy) object also invariably produces low 'global-frame-consistent' spatial measures (e.g., in the vicinity of such 'high-energy-high-mass' object). Thus, it may be the case that General Relativity's described mechanical dynamics between the mass of objects and their curvature of 'space-time' (which interacts with these objects' charted space-time pathway) represents a particular instance embedded within the more comprehensive (CUFT) Universal Computational Formula's outline of a (singular) USCF's-series based D2 computation (e.g., comprising the three above mentioned 'Framework', Consistency' and 'Locus' Computational Dimensions) of the four basic 'physical' features of 'space', 'time', 'energy' and 'mass' interrelationships (e.g., as 'secondary' emerging computational products of this singular Universal Computational Formula driven process)...

Indeed, the CUFT's hypothesized rapid series of USCF's (governed by the above mentioned 'Universal Computational Formula') integrates (perfectly) between the essential quantum complimentary features of 'space and energy' or 'time and mass' (e.g., which arises as a result of the abovementioned 'computational exhaustiveness' of each of the Computational Framework Dimension's 'frame' and 'object' levels, which was represented earlier by one of the derivations of the Universal Computational Formula); "quantum entanglement", the "uncertainty principle" and the "particle-wave duality" (e.g., which arises from the existence of the postulated 'Universal Simultaneous Computational Frames' [USCF's] that compute the entire spectrum of the physical universe simultaneously per each given USCF and which embed within each of these USCF's any 'single- spatial-temporal' measurements of "entangled particles" as constituting integral parts of a 'multiple spatial-temporal' "wave" patterns); Quantum mechanics' minimal degree of physical change represented by Planck's 'h' constant (e.g., which signifies the CUFT's 'minimal degree of inter-USCF's change' for all four 'physical' features of 'space', 'time', 'energy' and 'mass'); As well as the relativistic well validated physical laws and phenomena of the "equivalence of energy and mass" (e.g., the famous "E= Mc²" which arises as a result of the transformation of any given object's or event's 'frame-inconsistent' to 'object-consistent' computational measures based on the maximal degree of change, but which also involves the more comprehensive and integrated Universal Computational Formula derivation: $t \times m \times (c^2/h \times \gamma) = s \times e$.); Relativity's 'space-time' and 'energy-mass' relationships expressed in terms of their constitution of an integrated singular USCF's series which is given through an alternate derivation of the same Universal Computational Formula:

$$\frac{s}{t} = \frac{m \times \left(\frac{c^2 \times \gamma}{h} \right)}{e}$$

Indeed, this last derivation of the Universal Computational Formula seems to encapsulate General Relativity's proven dynamic relationships that exist between the curvature of space-time by mass and its effect on the space-time pathways of any such (massive) object/s - through the complete integration of all four physical features within a singular (conceptually higher-ordered 'D2') USCF's series... Specifically, this (last) derivation of the (abovementioned) Universal Computational Formula seems to integrate between 'space-time' - i.e., as a ratio of a 'frame-consistent' computational measure divided by 'object-inconsistent' computational measure - as equal to the computational ratio that exists between 'mass' (e.g., 'object-consistent') divided by 'energy' (e.g., 'frame-inconsistent') multiplied by the Rate of Universal Computation ($R = c^2/h$) and multiplied by the Universal Computational Principle's operation (γ); Thus, the CUFT's (represented by the above Universal Computational Formula) may supply us with an elegant, comprehensive and fully integrated account of the four basic 'physical' features constituting the physical universe (e.g., or indeed any set of computational object/s, event/s or phenomena etc.): Therefore, also the Universal Computational Formula's full integration of Relativity's maximal degree of inter-USCF's change (e.g., represented as: 'c²') together with Quantum's minimal degree of inter-USCF's change (e.g., represented by: Planck's constant 'h') produces the 'Rate' {R} of such rapid series of USCF's as: $R = c^2/h$, which is computed by the Universal Computational Principle ' γ ' and gives rise to all four 'physical' features of 'space',

'time', 'energy' and 'mass' as integral aspects of the same rapid USCF's universal computational process.

Thus, we can see that the discovery of the hypothetical Computational Unified Field Theory's (CUFT's) rapid series of USCF's fully integrates between hitherto validated quantum and relativistic empirical phenomena and natural laws, while resolving all of their apparent contradictions.

6. CUFT: Theoretical ramifications

Several important theoretical ramifications may follow from the CUFT; First, the CUFT's (novel) definition of 'space', 'time', 'energy' and 'mass' – as emerging computational properties which arise as a result of different combinations of the three Computational Dimensions (e.g., of 'Framework', 'Consistency' and 'Locus') transform these apparently "physical" properties into (secondary) 'computational properties' of a D2 series of USCF's... This means that instead of 'space', 'energy', 'mass' and 'time' existing as "independent - physical" properties in the universe they arise as '*secondary integrated computational properties*' (e.g., 'object'/'frame' x 'consistent'/'inconsistent' x 'global'/'local') of a singular conceptually higher-ordered 'D2' computed USCF's series...

Second, such CUFT's delineation of the USCF's arising (secondary) computational features of 'space', 'time', 'energy' and 'mass' is also based on one of the (three) postulates of the CUFT, namely: the 'Duality Principle', i.e., recognizing the computational constraint set upon the determination of any "causal-physical" relationship between any two (hypothetical) interacting 'x' and 'y' elements (at any direct 'di1' or indirect '...din' computational level/s), but instead asserting only the existence of a conceptually higher-ordered 'D2' computational level which can compute only the "co-occurrences" of any two or more hypothetical spatial-temporal events or phenomena etc. This means that the CUFT's hypothesized 'D2' computation of a series of (extremely rapid) USCF's does not leave any room for the existence of any (direct or indirect) "causal-physical" 'x→y' relationship/s. Instead, the hypothesized D2 A-Causal Computation calls for the computation of the co-occurrences of certain related phenomena, factors or events – but which lack any "real" 'causal-physical' relationship/s (phenomena or laws)...

Third, the Duality Principle's above mentioned necessity to replace any (direct or indirect) causal-physical relationship (or scientific paradigm), e.g., "x→y" by the CUFT's hypothesized D2 A-Causal Computation of the "co-occurrence" of particular spatial-temporal factors, events, phenomena etc. that constitute certain 'spatial-pixels' within a series of USCF's may have significant theoretical ramifications for several other key scientific paradigms (across the different scientific disciplines); Specifically, it is suggested that perhaps an application of the Duality Principle's identified- and constrained- SROCS computational structure (e.g., of the general form: $PR\{x,y\}/di1 \rightarrow [y \text{ or 'not } y']/di1$) towards key existing scientific paradigms such as: 'Darwin's Natural Selection Principle', 'Gödel's Incompleteness Theorem' (e.g., and Hilbert's failed 'Mathematical Program'), Neuroscience's (currently assumed) 'materialistic-reductionistic' working hypothesis etc. may open the door for a potential reformalization of these scientific paradigms in a way that is compatible with the novel computational Duality Principle and its ensued CUFT.

Hence, to the extent that the hypothesized CUFT may replicate (adequately) all known quantum and relativistic empirical phenomena and moreover offer a satisfactory (conceptually higher-ordered 'D2') USCF's series based computational framework that may

harmonize- and bridge the gap- between quantum and relativistic models of physical reality, the CUFT may constitute a potential candidate to integrate (and replace) both quantum and relativistic theoretical models; However, in order for such (potentially) serious theoretical consideration to occur, the next required step will be to identify those particular (empirical) instances in which the CUFT's predictions may differ (significantly) from those of quantum mechanics or Relativity theory.

7. Conclusion

In order to address the principle contradiction that exists between quantum mechanics and Relativity Theory (e.g., comprising of: Probabilistic vs. deterministic models of physical reality, "*Simultaneous-entanglement*" vs. "*non-simultaneous-causality*" features and Single vs. multiple spatial-temporal modeling) a computational-empirical analysis of a fundamental 'Self-Referential Ontological Computational System' (SROCS) structure underlying both theories was undertaken; It was suggested that underlying both quantum and relativistic modeling of physical reality there is a mutual 'SROCS' which assumes that it is possible to determine the 'existence' or 'non-existence' of a certain 'y' factor solely based on its *direct physical interaction* (PR{x,y}/di1) with another 'x' factor (e.g., at the same 'di1' computational level), thus:

$$\text{SROCS: PR}\{x,y\}/\text{di1} \rightarrow [\text{'y' or 'not y'}]/\text{di1}.$$

In the case of Relativity theory, such basic SROCS computational structure pertains to the computation of any spatial-temporal or energy-mass value/s of any given event (or object) – based (solely) on its *direct physical interaction* with any hypothetical (differential) relativistic observer:

$$\begin{aligned} \text{SROCS: PR}\{\text{O-diff, P}\{s-t (i\dots n), e-m (i\dots n)\} \}/\text{di1} \\ \rightarrow \{\text{'P}\{s-t (i), e-m (i)\}' \text{ or 'not P}\{s-t (i), e-m (i)\}'\}/\text{di1} \end{aligned}$$

In the case of quantum mechanics, it is hypothesized that precisely the same SROCS/SRONCS computational structure may pertain to the quantum mechanical computation of the physical properties of any given subatomic 'target' (e.g., assumed to be dispersed all along a probability wave function) that is hypothesized to be determined solely through its direct physical interaction with another subatomic complimentary 'probe' entity, thus:

$$\begin{aligned} \text{SROCS: PR}\{\text{P}\{s-e' \text{ or 't-m'}, t [s-e (i\dots n), t-m (i\dots n)] \}/\text{di1} \\ \rightarrow [\text{'t [s-e (i), t-m (i)]}' \text{ or 'not t [s-e (i), t-m (i)]}'\}/\text{di1} \end{aligned}$$

However, the computational-empirical analysis indicated that such SROCS computational structure (which underlies both quantum and relativistic paradigms) inevitably leads to both '*logical inconsistency*' and ensuing '*computational indeterminacy*' (i.e., an apparent inability of these quantum or relativistic SROCS systems to determine whether a particular spatial-temporal or energy-mass 'Phenomenon' or a particular spatial-energetic or temporal-mass target value "*exists*" or "*doesn't exist*"). But, since there exists ample empirical evidence indicating the capacity of these quantum or relativistic computational systems to determine the "*existence*" or "*non-existence*" of any particular relativistic 'Phenomenon' or quantum complimentary target value, then a novel computational 'Duality Principle' asserts

that the currently assumed SROCS computational structure is invalid; Instead, the Duality Principle points at the existence of a conceptually higher-ordered ('D2') "a-causal" computational framework which computes the "co-occurrences" of any range of quantum 'probe-target' or relativistic 'observer-Phenomenon' pairs thus:

1. D2: {P('e-s' or 't-m'), T [e-s (i), t-m (i)]; ... P('e+n/s+n' or 't+n/m+n'), T [(e+n) (s+n), (t+n) (m+n)]} ≠ PR{[P('e-s' or 't-m'), T (e-s (i), t-m (i)); ... P('e+n/s+n' or 't+n/m+n'), T (e+n) (s+n), (t+n) (m+n)]}/di1
2. 'D2': {P [s-t (i...n) e-m (i...n), O-r(st-i)]; ... P[s-t (i+n) e-m (i+n), O-r(st-i+n)]} ≠ PR{O-diff, P[s-t (i...n), e-m (i...n)]}/di1.

Indeed, a further application of this (new) hypothetical computational Duality Principle indicated that there cannot exist "multiple D2" computational levels but rather only one singular 'conceptually higher-ordered 'D2' computational framework as underlying both quantum and relativistic (abovementioned) 'co-occurring' phenomena.

Next, an examination of the potential characteristics of such conceptually higher-ordered (singular) 'a-causal D2' computational framework indicated that it may embody 'single'- 'multiple'- and 'exhaustive' spatial-temporal measurements as embedding all hypothetical 'probe-target' subatomic pairs or all hypothetical (differential) observer/s - 'Phenomenon' pairs; It was suggested that such D2 (singular 'a-causal') arrangement of all hypothetical quantum 'probe-target' or relativistic 'observer-Phenomenon' pairs may give rise to all known *single* spatial-temporal (quantum) "particle" or (relativistic) "object" or "event" measurements or all *multiple* spatial-temporal "wave" measurements. Moreover, when we broaden our computational analysis beyond the scope of such 'single'- or 'multiple' spatial-temporal measurements (or conceptualizations) to the entire corpus of all hypothetical possible spatial-temporal points- e.g., as 'co-occurring' at the Duality Principle's asserted conceptually higher-ordered 'D2' computational framework, then this may point at the existence of a series of 'Universal Simultaneous Computational Frames' (USCF's). The existence of such (a series of) hypothetical conceptually higher-ordered 'D2' series of USCF's which constitute the entirety of all hypothetical (relativistic) spatial-temporal or energy-mass phenomena and all hypothetical (quantum complimentary) spatial-energetic or temporal-mass "pixels" was suggested by the well-validated empirical phenomenon of 'quantum entanglement' (e.g., relating to a 'computational linkage' between 'greater than light-speed travelling distance' of two spatial-temporal "entangled particles"); This is because based on the fact that two such disparate 'entangled' quantum "particles" (e.g., which could hypothetically comprise a probability wave function that can span tremendous cosmic distances) we may infer that the entirety of all (hypothetical) cosmic quantum (complimentary) 'probe-target' pairs or all (hypothetical) relativistic 'observer-Phenomenon' pairs may be computed as "co-occurring" simultaneously as part of such (hypothetical) 'D2' 'Universal Simultaneous Computational Frames' (USCF's).

This hypothetical (rapid series of) 'Universal Simultaneous Computational Frames' (USCF'S) was further stipulated to possess three basic (interrelated) 'Computational Dimensions' which include: Computational 'Framework' (e.g., relating to the entire USCF/s 'frame/s' or to a particular 'object' within the USCF/s), Computational 'Consistency' (which refers to the degree of 'consistency' of an object or of segments of the frame across a series of USCF's (e.g., 'consistent' vs. 'inconsistent'), and Computational 'Locus' of (e.g., whether the computation is carried out 'locally'- from within any particular object or 'reference system', or 'globally'-

i.e., externally to a particular reference system from the perspective of the entire frame or segments of the frame). Interestingly (partially) by using a '*cinematic film metaphor*' it was possible to derive and formalize each of the four basic physical features of 'space', 'time', 'energy' and 'mass' as emerging (secondary) computational properties arising from the singular 'D2' computation of a series of USCF's – through a combination of the two Computational Dimensions of 'Framework' and 'Consistency': Thus, a combination of the 'object' level (e.g., within the 'Framework' Dimension) with the 'consistent' vs. 'inconsistent' levels (of the 'Consistency' Dimension) produced the physical properties of 'mass' and 'time' (correspondingly); On the other hand, a combination of the 'frame' level (within the Framework Dimension) and the 'consistent' vs. 'inconsistent' ('Consistency' Dimension) yielded the two other basic physical features of 'space' and 'energy'. It was further hypothesized that (following the cinematic-film analogy) the minimal (possible) degree of 'change' across any two (subsequent) 'Universal Simultaneous Computational Frames' (USCF's) is given by Planck's '*h*' constant (e.g., for the various physical features of 'space', 'time', 'energy' or 'mass'), whereas the maximal (possible) degree of change across two such (subsequent) USCF's is given by: '*c*²'; Finally, the 'rate' at which the series of USCF's may be computed (or presented) was hypothesized to be given by: $c^2/h!$

Hence, based on the above mentioned three basic theoretical postulates of the 'Duality Principle' (e.g., including the existence of a conceptually higher-ordered 'D2 A-Causal' Computational framework), the existence of a rapid series of 'Universal Simultaneous Computational Frames' (USCF's) and their accompanying three Computational Dimensions of – 'Framework' ('frame' vs. 'object'), 'Consistency' ('consistent' vs. 'inconsistent') and 'Locus' ('global' vs. 'local') a (novel) 'Computational Unified Field Theory' (CUFT) was hypothesized; Based on a computational formalization of each of the four basic physical features of 'space' and 'energy', 'mass' and 'time' (e.g., which arise as secondary computational measures of the singular D2 rapid series of USCF's Computational Dimensions combination of '*frame*': 'consistent' vs. 'inconsistent' and '*object*': 'consistent' vs. 'inconsistent', correspondingly), the hypothesized 'Computational Unified Field Theory' (CUFT) can account for all known quantum and relativistic empirical findings, as well as seem to 'bridge the gap' between quantum and relativistic modeling of physical reality: Specifically, the various relativistic phenomena were shown to arise based on the interaction between the two ('global' vs. 'local') 'Framework' and (consistent vs. inconsistent) 'Consistency' computational dimensions. Conversely, a key quantum complimentary feature that characterizes the probabilistic interpretation of the 'uncertainty principle' (e.g., as well as the currently assumed "collapse" of the probability wave function) was explained based on the '*computational exhaustiveness*' arising from the computation of both the 'consistent' and 'inconsistent' aspects (or levels) of the Computational Dimensions' levels of '*frame*' or '*object*'; Thus for instance, both the 'consistent' and 'inconsistent' aspects (or levels) of the (Framework dimension's) 'frame' level (e.g., which comprise the quantum measurements of 'space' and 'energy', respectively) exhaustively describe the entire spectrum of this 'frame' computation. Thus, for instance, if we opt to increase the accuracy of the subatomic 'spatial' ('frame-consistent') measurement, then we also necessarily decrease the computational accuracy of its converse (exhaustive) 'energy' (e.g., 'frame-inconsistent') measure etc. Indeed, such CUFT's reformalization of the key quantum and relativistic laws and empirical phenomena as arising from the singular (rapid series of) USCF's interrelated (secondary)

computational measures (e.g., of the four basic quantum and relativistic physical features of 'space', 'time', 'energy' and 'mass' has led to the formulation of a singular '*Universal Computational Formula*' which was hypothesized to underlie- harmonize- and broaden- the current quantum and relativistic models of physical reality:

$$\frac{c^2 x'}{h} = \frac{s \times e}{t m}$$

wherein the left side of this singular hypothetical Universal Computational Formula represents the (abovementioned) universal rate of computation by the hypothetical Universal Computational Principle, whereas the right side of this Universal Computational Formula represents the 'integrative-complimentary' relationships between the four basic physical features of 'space' (s), 'time' (t), 'energy' (e) and 'mass' (m), (e.g., as comprising different computational combinations of the three (abovementioned) Computational Dimensions of 'Framework', 'Consistency' and 'Locus';

Note that on both sides of this Universal Computational Formula there is a coalescing of the basic quantum and relativistic computational elements – such that the rate of Universal Computation is given by the product of the maximal degree of (inter-USCF's relativistic) change 'c²' divided by the minimal degree of (inter-USCF's quantum) change 'h'; Likewise, the right side of this Universal Computational Formula meshes together both quantum and relativistic computational relationships – such that it combines between the relativistic products of space and time (s/t) and energy-mass (e/m) together with the quantum (computational) complimentary relationship between 'space' and 'energy', and 'time' and 'mass'; Significantly, it was suggested that the three (above mentioned apparent) principle differences between quantum and relativistic theories, namely: '*probabilistic*' vs. '*positivistic*' models of physical reality, '*simultaneous-entanglement*' vs. '*non-simultaneous causality*' and '*single-*' vs. '*multiple-*' *spatial-temporal modeling* can be explained (in a satisfactory manner) based on the new (hypothetical) CUFT model (represented by the Universal Computational Formula);

Finally, there may be important theoretical implications to this (new) hypothetical CUFT; First, instead of 'space', 'energy', 'mass' and 'time' existing as "*independent-physical*" properties in the universe they may arise as '*secondary integrated computational properties*' (e.g., 'object'/'frame' x 'consistent'/'inconsistent' x 'global'/'local') of a singular conceptually higher-ordered 'D2' computed USCF's series...

Second, based on the 'Duality Principle' postulate underlying the CUFT which proves the conceptual computational constraint set upon the determination of any "causal-physical" relationship between any two (hypothetical) 'x' and 'y' elements (at the 'dil' computational level), we are forced to recognize the existence of a conceptually higher-ordered 'D2' computational level which can compute only the "co-occurrences" of any two or more hypothetical spatial-temporal events or phenomena etc. This means that the CUFT's hypothesized 'D2' computation of a series of (extremely rapid) USCF's does not leave any room for the existence of any (direct or indirect) "causal-physical" 'x→y' relationship/s, but instead points at the . singular conceptually higher-ordered D2 A-Causal Computation which computes the co-occurrences of certain related phenomena, factors or events...

Third, an application of one of the three theoretical postulates underlying this novel CUFT, namely: the 'Duality Principle' to other potential 'Self-Referential Ontological Computational Systems' (SROCS) including: 'Darwin's Natural Selection Principle', 'Gödel's

Incompleteness Theorem' (e.g., and Hilbert's "failed" 'Mathematical Program'), Neuroscience's (currently assumed) 'materialistic-reductionistic' working hypothesis etc. (Bentwich, 2003a, 2003b, 2003c, 2004, 2006a, 2006b) (may open the door for a potential reformalization of these scientific paradigms in a way that is compatible with the novel computational Duality Principle and its ensued CUFT.

8. Acknowledgment

I would like to greatly thank Mr. Brian Fisher for his continuous input, support and encouragement of the development of the ideas that have led to the CUFT - without whom this work would not have been possible; I would like to thank my wife, Dr. Talyah Unger-Bentwich for her unflinching support and dialogue for the past fourteen years which have allowed me to work productively on this theory. I'd like to thank my dear mother, Dr. Tirza Bentwich for her lifelong nurturance of my thinking which have formed the basis for the development of this theory. Finally, I'd like to thank Dr. Boaz Tamir for a few discussions prior to the publication of this chapter.

9. References

- Bagger, J. & Lambert, N. (2007). Modeling multiple M2's. *Phys. Rev. D*, Vol. 75, No. 4, 045020
- Bentwich, J. (2003a). From Cartesian Logical-Empiricism to the 'Cognitive Reality': A Paradigmatic Shift, *Proceedings of Inscriptions in the Sand, Sixth International Literature and Humanities Conference*, Cyprus
- Bentwich, J. (2003b). The Duality Principle's resolution of the Evolutionary Natural Selection Principle; The Cognitive 'Duality Principle': A resolution of the 'Liar Paradox' and 'Goedel's Incompleteness Theorem' conundrums; From Cartesian Logical-Empiricism to the 'Cognitive Reality: A paradigmatic shift, *Proceedings of 12th International Congress of Logic, Methodology and Philosophy of Science*, August Oviedo, Spain
- Bentwich, J. (2003c). The cognitive 'Duality Principle': a resolution of the 'Liar Paradox' and 'Gödel's Incompleteness Theorem' conundrums, *Proceedings of Logic Colloquium*, Helsinki, Finland, August 2003
- Bentwich, J. (2004). The Cognitive Duality Principle: A resolution of major scientific conundrums, *Proceedings of The international Interdisciplinary Conference*, Calcutta, January
- Bentwich, J. (2006a). The 'Duality Principle': Irreducibility of sub-threshold psychophysical computation to neuronal brain activation. *Synthese*, Vol. 153, No. 3, pp. (451-455)
- Bentwich, J. (2006b). *Universal Consciousness: From Materialistic Science to the Mental Projection Unified Theory*, iUniverse Publication
- Born, M. (1954). The statistical interpretation of quantum mechanics, *Nobel Lecture*, December 11, 1954
- Brumfiel, G. (2006). Our Universe: Outrageous fortune. *Nature*, Vol. 439, pp. (10-12)
- Ellis, J. (1986). The Superstring: Theory of Everything, or of Nothing? *Nature*, Vol. 323, No. 6089, pp. (595-598)
- Greene, B. (2003). *The Elegant Universe*, Vintage Books, New York
- Heisenberg, W. (1927). Über den anschaulichen Inhalt der quantentheoretischen Kinematik und Mechanik. *Zeitschrift für Physik*, Vol. 43 No. 3-4, pp. (172-198)

- Horodecki, R.; Horodecki, P.; Horodecki, M. & Horodecki, K. (2007). Quantum entanglement. *Rev. Mod. Phys*, Vol. 81, No. 2, pp. (865–942)
- Polchinski, J. (2007) All Strung Out? *American Scientist*, January-February 2007 Volume 95, Number 1
- Stephen W. Hawking Godel and the end of Physics. (Public lecture on March 8 at Texas A&M University)
- On the right track. Interview with Professor Edward Witten, *Frontline*, Vol. 18, No. 3, February 2001
- Witten, E. (1998). Magic, Mystery and Matrix. *Notices of the AMS*, Vol. 45, No. 9, pp. (1124-1129)

Theoretical Validation of the Computational Unified Field Theory (CUFT)

Jonathan Bentwich
Brain Perfection LTD
Israel

"No better destiny could be allotted to any physical theory, than that it should of itself point out the way to the introduction of a more comprehensive theory, in which it lives on as a limiting case"

(Einstein, 1916)

1. Introduction

A previous article (Bentwich, 2011c) hypothesized the existence of a novel 'Computational Unified Field Theory' (CUFT) which was shown to be capable of replicating quantum and relativistic empirical phenomena and furthermore may resolve the key inconsistencies between these two theories; The CUFT (Bentwich, 2011c) is based upon three primary postulates including: the computational '*Duality Principle*' (e.g., consisting of an empirical-computational proof for the principle inability to determine the "existence" or "non-existence" of any hypothetical 'y' element based on its direct physical interaction with another exhaustive set of 'x' factors) (Bentwich, 2003 a,b,c; 2004; 2006a); the existence of an extremely rapid series (e.g., c^2/h) of '*Universal Simultaneous Computational Frames*' (USCF's) which comprise the entire corpus of the physical spatial universe at any given minimal (quantum temporal 'h') point (which is computed by a 'Universal Computational Principle', ''); and the existence of three '*Computational Dimensions*' – e.g., of 'Framework' ('frame' vs. 'object'), 'Consistency' ('consistent' vs. 'inconsistent') and Locus ('global' vs. 'local'); Taken together these three basic theoretical postulates give rise to the CUFT's 'Universal Computational Formula':

$$\frac{c^2 x'}{h} = \frac{s \times e}{t \times m}$$

which fully integrates between the four basic physical properties of 'space', 'time', 'energy' and 'mass' and is capable of replicating all known quantum and relativistic phenomena, while resolving the apparent contradictions between Quantum Mechanics and Relativity Theory (such as for instance the existence of the relativistic speed of light limit as opposed to the quantum entanglement's instantaneous phenomenon).

Moreover, even beyond the capacity of the CUFT to replicate all known quantum and relativistic phenomena as well as resolve their key theoretical inconsistencies (and differences), the CUFT was postulated to broaden the scope of our theoretical

understanding of physical reality thereby qualifying as a potential candidate for a 'Theory of Everything' (TOE) (Brumfiel, 2006; Einstein, 1929, 1931, 1951; Ellis, 1986; Greene, 2003). Specifically, based on the (abovementioned) integrated postulates of the 'Duality Principle', existence of the 'Universal Simultaneous Computational Frames' (USCF's) and three (Framework, Consistency and Locus) Computational Dimensions the CUFT describes the four basic physical properties of 'space', 'time', 'energy' and 'mass' as emerging (secondary) computational properties that arise as a result of various 'Framework x Consistency x Locus' combinations - as computed (by the Universal Computational Principle, 'U') based on the rapid series of USCF's...

However, in order to fully validate this new (hypothetical) 'Computational Unified Field Theory' (CUFT), it is necessary to further extend its theoretical framework to bear on (at least) two important aspects: i.e., to identify particular instances in which the predictions of the CUFT *critically differ* from those of both Quantum and Relativistic models, and to demonstrate the potency of the CUFT in broadening our understanding of key scientific phenomena (e.g., while demonstrating the need to perhaps reformulate these key scientific computational paradigms based on the CUFT's new broader theoretical scientific framework);

Hence, the current chapter comprises two segments : the first critically contrasts (at least) three specific instances in which the critical predictions of the CUFT significantly differs from that of both quantum mechanics and Relativity theory; and the second, which delineates the application of one of the three major theoretical postulates of the CUFT (namely: the 'Duality Principle') in the particular cases of three key scientific (computational) paradigms (including: Darwin's 'Natural Selection Principle' and associated 'Genetic Encoding Hypothesis' and Neuroscience's basic materialistic-reductionistic 'Psycho-Physical Problem');

We therefore begin by identifying (at least) three specific empirical predictions of the CUFT which may critically differ from those predicted by the existing quantum and relativistic theoretical models;

- a. Contrasting between the CUFT's *Universal Computational Formula's* '1' and '2' derivatives and their corresponding relativistic and quantum empirical predictions;
- b. Contrasting between the CUFT's critical prediction regarding the differential number of times that a "massive" compound (or atom/s) will be presented (consistently) across a series of subsequent USCF's relative to the number of times that a "lighter" compound (or atom/s) will be presented across the same number of (serial) USCF's, and the corresponding predictions of Quantum or Relativistic theories.
- c. Critically contrasting between the CUFT's prediction of the possibility of reversing any given object's spatial-temporal sequence (e.g., based on a computation of that object's serial electromagnetic values across a series of USCF's and reversal of these recorded values based an application of the appropriate electromagnetic field to that object's recorded serial USCF's electromagnetic values) - and the *negation* of any such capacity to reverse the 'flow of time' by both Quantum and Relativistic theories

2. The CUFT's universal computational formula's relativistic & quantum derivatives

The first (of these three) differential critical predictions for which the CUFT's empirical predictions may differ significantly from those of both quantum and relativistic theoretical models is based upon the CUFT's Universal Computational Formula:

$$\frac{c^2 x'}{h} = \frac{s x e}{t x m}$$

Specifically, whereas Relativity theory recognizes the equivalence of mass and energy (e.g., $E = Mc^2$), the unification of 'space' and 'time' as a four-dimensional continuum, and its curvature by mass – *Relativity Theory does not allow for the complete unification* (or transformation) of all of these *four basic physical features* (e.g., within one computational formula); In contrast, the CUFT's defines each of these four basic physical features in terms of their (particular) combination of three Computational Dimensions, e.g., 'Framework' ('frame'/'object'), 'Consistency' ('consistent'/'inconsistent') and 'Locus' ('global'/'local') which are all anchored in the *same singular* (higher-ordered D2) *rapid series of 'Universal Simultaneous Computational Frames'* (USCF's). Thus, for instance it was shown (Bentwich, 2011c) that the computational definition of 'space' and 'energy', or of 'mass' and 'time' constitute exhaustive computational pairs delineating a *frame's* – or an *object's* – consistent vs. inconsistent computational measures (e.g., across a series of subsequent USCF's, respectively); (In fact, it was precisely this '*computational exhaustiveness*' of these frame- or object- consistency measures that was suggested to offer an alternative explanation for the currently accepted quantum's probabilistic interpretation of the "collapse" of the 'probability wave function'.)

Indeed, it is hereby hypothesized that this unique capability of the CUFT's Universal Computational Formula to comprehensively unify between all four basic physical features (e.g., 'space', 'time', 'energy' and 'mass') – not only goes beyond the capacity of the existing (relativistic or quantum) theoretical models, but also produces particular (verifiable) empirical predictions that may critically from those offered by either quantum or relativistic theoretical models:

Thus, it is suggested that the two previously outlined (Bentwich 2011c) computational derivatives of the Universal Computational Formula:

$$\frac{s}{t} = \frac{m}{e} x \frac{c^2 x'}{h} \quad (1)$$

$$t x m x \left(\frac{c^2 x'}{h} \right) = s x e \quad (2)$$

may (in fact) provide precisely such (differential) critical predictions of the CUFT as opposed to their (respective) relativistic (1) and quantum (2) predictions.

This is because according to the CUFT's Universal Computational Formula's (1) derivative a (relativistic or quantum) object's 'space' value divided by its 'time' value is equivalent to that object's 'mass' value divided by its 'energy' value – multiplied by the square of the speed of light (c^2) divided by Planck's constant ('h') (e.g., and based on the higher-ordered D2 'Universal Computational Principle's computation of the given series of USCF's); In the case of the CUFT, the computational rationale for this equivalence of ' $s/t = m/e \times (c^2/h \times x')$ ' stems from its stipulation that the ratio between an object's 'frame-consistent' ('s') and 'object-inconsistent' ('t') values should be the same as between that object's 'object-consistent' ('m') and 'frame-inconsistent' ('e') values – multiplied by the rate of universal computation (e.g., c^2/h) (e.g., as delineated in the previous publication: Bentwich, 2011c). However, when contrasting this particular CUFT's Universal Computational Formula (I) with its counterpart in Relativity Theory we find that even though relativistic theory possesses specific

equivalences between 'energy' and 'mass' (e.g., the famous 'E = Mc²') and the unification of 'space-time' as a 'four-dimension' continuum, it fails to account for any such comprehensive equivalence of 's'/t' = 'm'/e' x (c²/h x " "); In fact, if we focus on the (above) relativistic 'energy-mass' equivalence ('E = mc²') we can notice that the CUFT's Universal Computational Formula's (I) derivative 's'/t' = 'm'/e' x (c²/h x " ") in fact *contains this 'energy-mass' equivalence but goes beyond that equivalence* to incorporate also its precise (hypothetical) relationship with the (ratio between) 'space' and 'time' as well as with the (hypothetical) rate of universal computation (e.g., c²/h x " "); These broader CUFT Universal Computational Formula's (I) relationships between 'space' and 'time' and the (hypothesized) 'universal computational rate' (c²/h x " ") – and Relativity's (known) 'energy-mass equivalence' could be represented in this manner:

$$'e' \times 's'/t' = 'm' \times c^2/h (x 'h')$$

In this way, we can see that the CUFT Universal Computational Formula's (1 derivative) contains (and replicates) Relativity's core 'energy-mass equivalence' ('E = mc²'), but also goes beyond that particular relationship as embedded within a broader more comprehensive (singular) Universal Computational Formula's unification of the four basic physical features (e.g., of 'space', 'time', 'energy' and 'mass'). As such, the above first derivative of the Universal Computational Formula (1) points at a particular empirical instant in which one of the CUFT's critical predictions *differs* from those offered by Relativity Theory.

A second instance in which the CUFT's (critical) empirical prediction may differ from that of Quantum Mechanic is in the case of the CUFT Universal Computational Formula's (2) derivative – as it relates to an extension of quantum's (current) particular complimentary relationships between a subatomic object's or event's 'spatial' and 'energetic' or 'temporal' and 'mass' values: According to the current quantum mechanical account of Heisenberg' 'Uncertainty Principle' (Heisenberg, 1927) there exist (strict) complimentary relationships between an object's (or event's) 'spatial' and 'energetic' values or between its 'temporal' and 'mass' properties – e.g., such that their simultaneous measurement accuracy level cannot (in principle) exceed Planck's minimal 'h' value... theoretically, this is due to the (currently prevailing) 'probabilistic interpretation' of quantum mechanics which posits that it is due to the direct physical interaction between the subatomic 'probe' and 'target' elements that the probability wave function "collapses" – giving rise to a particular 'complimentary' spatial-energetic' or 'temporal-mass' value, and therefore that any increase in the accuracy measurement of any of these pairs' complimentary values (e.g., 'e' vs. 's'; or 't' vs. 'm') necessarily also brings about a proportional decrease in the measurement accuracy of the other complimentary pair's dyad); Hence, the current (probabilistic interpretation of) Quantum Mechanical theory posits a strict complimentary relationship between any subatomic target's (simultaneous) measurement of its 'spatial' and 'energetic' values or between its 'temporal' and 'mass' values – as necessarily constrained by the Uncertainty Principle:

$$'e' \times 's' \leq 'h';$$

or

$$'t' \times 'm' \leq 'h'.$$

In contrast, the second (2) derivative of the CUFT's Universal Computational Formula further broadens these apparently disparate quantum complimentary relationships (e.g., of

an object's 'spatial' and 'energetic', or 'temporal' and 'mass' values) – to form a direct computational equivalence, e.g., based on the hypothesized 'mechanics' of a Universal Computational Principle's higher-ordered 'D2'/'1' integrated computation of a rapid series of USCF's that singularly define each of these 'complimentary computational' pairs;

$$t \times m \times \left(\frac{c^2 x'}{h}\right) = s \times e$$

Specifically, the CUFT's Universal Computational Formula's (2) derivative hypothesizes that due to the fact that each of the four basic physical properties (e.g., of 'space', 'time', 'energy' and 'mass') is defined based on the same three fundamental (hypothesized) Computational Dimensions (i.e., of 'Framework' ['frame'/'object'], 'Consistency' ['consistent'/'inconsistent'] and 'Locus' ['global'/'local']) – which are all produced by the same *singular* (higher-ordered 'D2'/'1') rapid series *USCF's series*, then each of these complimentary computational pairs (i.e., of 'space' and 'energy', or 'mass' and 'time') exhaustively defines an object's given computational (USCF's based) measurement (Bentwich, 2011c). Thus, for instance, the CUFT hypothesized (Bentwich, 2011c) that an object's (or event's) 'temporal' value (e.g., which represents an 'object-inconsistent' USCF's Index) exhaustively compliments that object's 'mass' ('object-consistent') value, and likewise that an object's ('frame-consistent') 'spatial' USCF's measure exhaustively compliments its ('frame-inconsistent') 'energetic' measurement. Moreover, based (again) on the unification of all of these four basic physical properties as (secondary) computational combinations of the same three basic (abovementioned) Computational Dimensions (e.g., of 'Framework', 'Consistency' and 'Locus'), it was hypothesized that the computational relationship (i.e., multiplication) between an 'object-inconsistent' ('t') and 'object-consistent' ('m') measures should be equivalent to the (multiplication) relationships between a 'frame-consistent' ('s') and 'frame-inconsistent' ('t') values – i.e., while taking into considerations their production by a higher-ordered (D2)

Universal Computational Principle's ('1') rapid universal computational rate (e.g., $\frac{c^2 x'}{h}$);

Hence, the (2) derivative of the CUFT's Universal Computational Formula is expressed by the above:

$$t \times m \times \left(\frac{c^2 x'}{h}\right) = s \times e$$

But, note that this second derivative of the CUFT's Universal Computational Formula goes beyond the (abovementioned) current Quantum Mechanical Uncertainty Principle's complimentary measurement constraint stipulation:

$$'e' \times 's' \leq 'h';$$

or

$$'t' \times 'm' \leq 'h'.$$

This is because whereas the CUFT's (2) derivative explicitly stipulates that the multiplication relationship between the complimentary pair of {'t' and 'm'} is *equivalent* to that of {'e' and 'm'} (i.e., while taking into account its delineated relationship with the hypothetical rate of universal computation: $\frac{c^2 x'}{h}$), current quantum mechanical (probabilistic) formulation only

allows for a (partial) direct (multiplication) relationship between each of these complimentary pairs (e.g., independently).

Hence, an empirical contrast between the CUFT's Universal Computational Formula's (2) derivative and its corresponding quantum predictions also points at (potentially) significant differences between these theoretical models;

2.1 The CUFT's differential USCF's presentations of "massive" vs. "light" elements

Another interesting instance in which the predictions of the CUFT and Relativistic or Quantum models may critically differ is associated with the CUFT's computational definitions of an object's (relativistic or subatomic) "mass" value; Based on the CUFT's previous (Bentwich, 2011c) computational definition of an object's "mass" as the number of 'object-consistent' presentations across any series of USCF's – it was shown that the computation of the number of such 'object-consistent' ("mass" measure) from the 'global' ('g') framework of a relativistic object may indeed produce an increased 'mass' measure relative to its 'local' "mass" measure. This was due to the greater number of times such a relativistic object would be presented from the 'global' perspective relative to its 'local' perspective' based on the increased number of ('global') pixels such a relativistic object would have to traverse across a given series of USCF's (e.g., which would nevertheless not affect its 'locally' measured number of presentations).

However, a further extension of the CUFT's basic computational definition of an object's "mass" (e.g., as the number of 'object-consistent' presentations across a certain given number of USCF's) – when viewed from the 'local' framework perspective and when contrasting between relatively "massive" objects and "lighter" objects may in fact point an another interesting instance in which the critical predictions of the CUFT and Relativistic or Quantum models may differ significantly; This is because since the CUFT defines the "mass" of an object as the number of 'object-consistent' presentations across a series of USCF's, then when we compute a (relatively) "massive" object as opposed to a (relatively) "light" (relativistic) object – i.e., from the 'local' framework perspective, we obtain that the more "massive" object is necessarily presented a greater number of times across the same given number of USCF's than the "lighter" object! This means that according to the CUFT's critical prediction, we should obtain a difference in the number of (consistent) presentations of any two objects that (significantly) differ in their "mass" value... Thus, to the extent that we are capable of measuring a sufficiently minute number of consecutive USCF's, the CUFT predicts that more "massive" objects should appear consistently on a larger number of such consecutive USCF's – as opposed to (relatively) "lighter" objects which should appear less frequently across such a series of consecutive USCF's; More specifically, it is predicted that if we chose to examine the number of (consecutive) USCF's in which a (relatively) more "massive" compound (or element) appears – relative to a less "massive" compound (or element), then according to the CUFT we should expect to detect the more "massive" compound (or element) on a larger number of (consecutive) USCF's relative to the less "massive" compound or element; In contrast, according to the existing quantum or relativistic models of physical reality, the difference between more "massive" objects and less "massive" objects arises from the number of atoms comprising such objects, or differences in the weight of their nucleus etc.; However, there are no such known (quantum or relativistic) differences across elements (compounds or atoms, etc.) which possess differential mass values in terms of the "frequency" of their presentations (i.e., across a series of subsequent USCF's)...

Obviously, with the discovery of the CUFT's (hypothetical) far more rapid rate of USCF's computation (e.g., c^2/h) than the currently assumed quantum or relativistic (direct or indirect) relationships, and augmented by the CUFT's USCF's emerging (secondary computational) properties of "mass", "space", "energy" and "time" – such a critical contrast between the CUFT's empirically predicted *greater* number of (object-consistent) presentations of (relatively more) "*massive*" relative to a *lesser* number of (object-consistent) presentations for "*lighter*" objects, and the complete lack of such a prediction by either quantum or relativistic models may test the validity of the CUFT (as opposed to either quantum or relativistic theories).

2.2 Reversibility of USCF's spatial-temporal sequence

Another (intriguing) critical prediction of the CUFT which (significantly) differs from the current quantum or relativistic models of physical reality is regarding the potential capacity to alter the "spatial-temporal sequence" of any given (quantum or relativistic) phenomenon; The critical issue is that according to both quantum and relativistic theories the "*flow of time*" may only proceed in *one direction* (e.g., from the 'past' towards the 'future' – but not vice versa), which is often termed: the "arrow of time"; This is because from the standpoint of Relativity Theory there exists a strict 'speed of light' limit set upon the transmission of any signal or upon the speed at which any relativistic object can travel – which therefore prohibits our capacity to "catch-up" with any signal emanating from an event in the 'past'- or with any actual- event/s that has happened in the 'past'; The only tentative (hypothetical) possibility to re-encounter any such 'past' space-time events from the standpoint of Relativity is in a case in which there is an extreme curvature of space-time (due to the presence of extremely massive objects) which may create closed 'space-time loops' that may allow past signals to "turn around" and arrive back to the observer... But, even in this (rare) hypothetical instance, our hypothetical capacity would be only to *witness* a light signal that has emanated from an event that took place in the '*past*' – rather than any "real" capacity to "*reverse*" the spatial-temporal sequence of events or occurrences associated with the flow of time... Hence, from the perspective of Relativity Theory, we cannot "reverse" the flow of time – e.g., cause spatial-temporal events (or objects) to occur in the "reversed" order...

Likewise, from the perspective of Quantum Mechanics, there seems to exist a clear limit set upon our capacity to "reverse" the "flow of time" – due to the fact that our entire knowledge of any subatomic 'target' (phenomenon) is strictly dependent upon- (and is therefore also constrained by-) that 'target' element's direct (or indirect) physical interaction with another subatomic 'probe' element. Hence, according to the (current) probabilistic interpretation of Quantum Mechanics, the determination of the (complimentary) 'space-energy' (s/e) or 'temporal-mass' (t/m) values of any given subatomic 'target' phenomenon (or phenomena) can only be determined *following* its direct (or indirect) *physical interaction/s* with another subatomic 'probe' element; But, note that according to such (probabilistic interpretation of) Quantum Mechanical theory the subatomic 'target' element is dispersed 'all along' a 'probability wave function' *prior to its interaction with the probe element* – but "collapses" into a single (complimentary) 'space-energy' or 'temporal-mass' value immediately following its direct (or indirect) physical interaction with the 'probe' element. This means that according to current (probabilistic) quantum mechanical theory, there exists a clear "unidirectional" (asymmetrical) 'flow of time' – i.e., one in which the determination of any subatomic (target) phenomena can be determined only *following the collapse of the probability wave function* which takes place as a result of the direct (or indirect) physical interaction between the

(probability wave function's) 'target' and other subatomic 'probe' element (Born, 1954); Now, as shown previously (Bentwich, 2011b) the computational structure (implicitly) assumed by the (above) probabilistic interpretation of quantum mechanics produces a 'Self-Referential Ontological Computational System' (SROCS) – which was shown to inevitably lead to both 'logical inconsistency' and 'computational indeterminacy' that are contradicted by known quantum empirical findings and which therefore also pointed at the computational 'Duality Principle' (e.g., asserting the existence of a conceptually higher-ordered 'D2' computational level that is capable of computing the simultaneous "co-occurrence" of any exhaustive hypothetical 'probe-target' pairs series). But, even beyond the Duality Principle's challenging of the current (implicit SROCS computational structure underlying) the probabilistic interpretation of Quantum Mechanics, note that it is precisely this SROCS assumed computational structure – which prohibits the capacity of any "collapsed" target element (or phenomenon) to "revert back to its 'un-collapsed' probability wave function state"! Therefore, it becomes clear that from the perspective of (probabilistic) Quantum Mechanical theory we cannot reverse any spatial-temporal quantum event/s, phenomenon or phenomena...

In contrast, the CUFT postulated the existence of a (conceptually higher-ordered) rapid series (e.g., $c^2/h \times \text{"}$) of 'Universal Simultaneous Computational Frames' (USCF's) which give rise to all (secondary) computational properties of 'space', 'time', 'energy' and 'mass'; Specifically, the computational definition of "time" was given through a measure of the number of instances that an object is presented *inconsistently* across a given series of USCF's – relative to the USCF's displacement of the speed of light: $t : \sum_{o\{x,y,z\}} [USCF(n)] \neq o(i...j-1)\{(x),(y),(z)\} [USCF(1...n)] / c \times n\{USCF's\}$

Therefore, the less instances in which a given object is presented 'inconsistently' (across a given series of USCF's), the less 'time' passes for that object – e.g., as may be observed from a 'global' framework in the case of its measurement of a high speed relativistic observer or in the case of a 'massive' object etc.

In much the same way, an object's "spatial" or "mass" or "energy" values– are all derived based on differential (e.g., 'frame-consistent', 'object-consistent' or 'frame-inconsistent', respectively) secondary computational measures of the various combinations of the three (abovementioned) Computational Dimensions. As a matter of fact, all of these four basic physical features of 'space', 'time', 'energy' and 'mass' were entirely integrated within the singular 'Universal Computational Formula' (Bentwich, 2011c) which outlined their intricate relationships with the singular (conceptually higher-ordered 'D2/'") rapid series (c^2/h) of USCF's. One final key factor associated with the CUFT's conceptualization of the "flow of time" may arise from its replacement of any (hypothetical) 'causal-material' ($x \rightarrow y$) relationship between any two hypothetical 'x' and 'y' factors – by a conceptually higher-ordered 'D2 a-causal' computation which can compute the "co-occurrences" of any two such given 'x' and 'y' elements at any given spatial-temporal point/s (for any particular USCF(i) frame).

This is because when we take into consideration the CUFT's integrated postulates of the Duality Principle's (conceptual) proof for the inability to determine the "existence" or "non-existence" of any (hypothetical) 'y' element based on its direct physical interaction (e.g., at $di1...din$) with another (exhaustive set of) 'x' factor/s; and the existence of a (rapid series of) 'Universal Simultaneous Computational Frames' (USCF's) which are *computed simultaneously for all of the exhaustive pool of 'spatial pixels' that exist per any given (discrete) USCF(i)* (e.g., by the Universal Computational Principle, ") – this leads to the CUFT assertion that there

cannot exist any real "causal" relationship/s between any two hypothetical 'x' and 'y' elements (Bentwich, 2011c)... Instead, the CUFT postulated that all (exhaustive series) of 'universal spatial pixels' must be computed simultaneously as part of a particular (discrete) USCF(i) frame. Therefore, the CUFT also asserted that the appearance of any "material-causal" relationship between any two given 'x' and 'y' elements may only arise as a result of a certain (apparent) '*spatial-temporal patterns*' emerging across a series of USCF's - rather than as the result of any "real" (e.g., direct or indirect) physical interaction/s between the 'x' and 'y' factors (e.g., constituting a given SROCS quantum or relativistic paradigm); Therefore, the CUFT's standpoint (and ensuing empirical critical predictions) with regards to the issue of the "flow of time" may differ significantly from the strict 'unidirectional' and 'unaltered' "flow of time" assumed by both quantum and relativistic models; This is due to the fact that according to the CUFT, the computational "time" measure of any object - i.e., whether it relates to the 'passage of time' (e.g., including the possibility of 'time dilation') or to the 'direction or time' (e.g., including the currently assumed "arrow of time" by relativistic and quantum theories) is entirely contingent upon the number of inconsistent presentations of that object across a given series of USCF's, as well as the particular USCF's spatial-temporal "sequence" underlying the development of a given phenomenon (or particular 'sequence of events'); In order to explicate the CUFT's critical prediction regarding the possibility to "reverse the flow of time" - i.e., at least as it applies to a particular given object, let us analyze the (standard) "flow or time" as it applies say to the developmental processes taking place in a small plant (or ameba); According to the CUFT, the "*flow of time*" associated with such a small plant's growth essentially comprises a particular *sequence of spatial-temporal as well as energetic-and mass- changes* taking place in the particular plant - *across a series of USCF's*. In fact, based on the CUFT's postulated (higher-ordered 'D2') series of discrete USCF's that are comprised of an exhaustive universal pool of "spatial-pixels" (being computed for each individual USCF), a further postulate of the CUFT is that each of this exhaustive pool of 'universal spatial pixels' constitutes a particular *electromagnetic value* which is specific to a given spatial point within a particular USCF frame (e.g., as a single electromagnetic value). Thus, the "flow of time" associated with the growth of this given plant essentially comprises a particular series of specific electromagnetic value/s that are localized to particular 'universal spatial pixel/s' appearing at any particular (series of) USCF's frames...

But, if the above description of the CUFT's 'mechanics' underlying the "flow of time" is accurate, then based on the (earlier mentioned) computational definition of 'time' as the number of 'object-inconsistent' presentations (across a series of USCF's) and of the "flow of time" as the particular sequence of 'electromagnetic-spatial pixels' series underlying a given sequence of events (or phenomenon), then it should be possible (in principle, at least) to "reverse the flow of time" for a given object (e.g., such as for the abovementioned developing plant) through a manipulation of the sequential order of electromagnetic-spatial pixel values of that plant across a series of USCF's... Let there be a particular sequence of spatial-electromagnetic pixels points across a series of USCF's that exhaustively define that plant's growth curve; Now, based on the CUFT's strict definition of the "flow of time" for that given (developing) plant which comprises the particular sequence of spatial-electromagnetic pixels (series) across the given series of USCF's frames, it should be possible to exert a differential electromagnetic field manipulation of each of the given spatial-electromagnetic pixels per each of the USCF's frames so as to produce a "reversal" of the "flow of time" - i.e., the spatial-electromagnetic pixels series' values arranged in the reversed order (such that instead of a USCF's series running from '1... to n' it would run from 'n... to 1')!

The key point to be noted (here) is that whereas both relativistic and quantum theories assume a strict "*unidirectional*" and "*unaltered*" flow of time, the CUFT's computational definition of 'time' as the number of 'object-inconsistent' USCF's presentations and of the "flow of time" (direction) strictly depending on the *particular sequence of 'spatial-electromagnetic pixel' values* allows the CUFT to predict a (differential) critical prediction whereby it may be possible to "reverse the flow of time" of a given object through a manipulation of the sequence (e.g., order) of the series of the particular 'spatial-electromagnetic universal pixels' comprising the series of USCF's object presentation... Note that according to the CUFT there does not seem to exist any "objective", "unidirectional", or "unaltered" "flow of time" underlying the (quantum or relativistic) physical phenomena, but only a particular configuration of a certain sequence of 'spatial-electromagnetic universal pixels' that is presented in a particular sequence (e.g., comprising a given series of USCF's). Therefore, to the extent that we are able to manipulate (e.g., technologically) the 'spatial-electromagnetic pixels' values of an object across a series of USCF's (such that it follows the "reversed order" of the original USCF's series) then we have in fact "reversed the flow of time" for that particular object (or event)...

Moreover, from a purely technological standpoint, the process by which such a potential reversal of the (original) sequence of 'spatial-electromagnetic universal pixels' may be achieved (i.e., through a manipulation of the electromagnetic value/s of a given object's 'spatial-electromagnetic universal pixels' in order to produce the "reversed" spatial electromagnetic universal pixels' USCF's sequence) does not necessarily require the capacity to identify, compute and manipulate each and every individual USCF (i...n) frame, but instead necessitate the identification (computation) and manipulation of a "sufficiently large" number of USCF's from within a given pool of consecutive USCF's. (Due to the novelty of the possibility to manipulate the series of spatial-electromagnetic pixels values comprising a given object's "flow of time" the determination of the particular number or rate of such 'sampled' specific spatial-electromagnetic universal pixels (across a certain number of USCF's) that is necessary to accurately reverse that object's "time flow" sequence would have to be tested experimentally.)

Finally, it is clear that to the extent that these particular CUFT's empirical predictions regarding the possibility to "reverse the flow of time" for any given object (or event) based on the manipulation of its specific sequence of 'spatial-electromagnetic universal pixels' may be validated experimentally, this may open the door for a series of potentially far reaching scientific and technological advances in our understanding of the physical universe, as well as in some of its potential human clinical and other potential applications; Thus, for instance, if it may be possible to "reverse the flow of time" for a relatively small object it should be possible (e.g., at least in principle) to "reverse the flow of time" for an entire organism or for a particular (healthy or pathological, young, diseased or aged) cell/s, tissue/s or organ/s... Likewise, based on an extension of the identification of any given object's precise 'spatial-electromagnetic universal pixels' composition (e.g., across a certain series of USCF's) and the potential for altering that object's (single or multiple) pixels values through an electromagnetic manipulation of its particular pixels' values - it should be possible (e.g., again at least in principle) to also "encode" comprehensively the particular spatial-electromagnetic values pixels of any object, cell/s tissue/s or even an entire organism or physical object and subsequently either alter its composition (or condition), or even "de-materialize" it based on the application of appropriate electromagnetic field (that may 'counteract' the particular

'spatial- electromagnetic pixels' values of that object or certain elements within it) and subsequently "materialize" it elsewhere based on the appropriate application of the precise electromagnetic field that can produce that object's particular spatial-electromagnetic values (e.g., at any accessible point in space) (Bentwich, 2011a)...

Thus, a critical contrasting of three particular instances in which the CUFT's empirical predictions may significantly differ from the corresponding predictions offered by contemporary Quantum or Relativistic theories may validate the Computational Unified Field Theory – as not only replicating all known quantum and relativistic empirical phenomena as well as bridging the gap between their apparent theoretical inconsistencies (Bentwich, 2011c), but in fact may demonstrate the advantage of the CUFT over existing Quantum and Relativistic theoretical models (e.g., while incorporating all known quantum and relativistic phenomena within a broader novel theoretical framework); Hence, as outlined earlier, the aim of the second half of this chapter is to broaden the validation of the Computational Unified Field Theory (CUFT) through the application of one of its key theoretical postulates, namely: the computational 'Duality Principle' to a series of key (computational) scientific paradigms. Once again, to the extent that the computational-empirical analysis of each of these key scientific paradigms may be shown (below) to be constrained by the CUFT's postulated 'Duality Principle', this would both extend the construct validity of the CUFT (to other key scientific disciplines), as well as call for these scientific paradigms' reformulation based on this (novel) more comprehensive Computational Unified Field Theory (of which the Duality Principle is one of three principle theoretical postulates). Needless to say that given the new (hypothetical) Computational Unified Field Theory's aim – to not only unify between Quantum Mechanics and Relativity Theory (e.g., as shown previously: Bentwich, 2011c) but to fulfill the requirements of a 'Theory of Everything' (TOE) (Brumfiel, 2006; Einstein, 1929, 1931, 1951; Ellis, 1986; Greene, 2003), a demonstration of the potential applicability of the CUFT to a series of key scientific paradigms may be significant as part of its theoretical validation process;

3. The 'Duality Principle': Potential resolution of key 'Self-Referential Ontological Computational Systems' (SROCS) scientific paradigms

To the extent that a series of key scientific paradigms can be shown to be constrained by the Computational Unified Field Theory's (CUFT) postulated 'Duality Principle' (Bentwich, 2011c), there emerges a need to re-formalize each of these central scientific paradigms based on the Duality Principle's higher-ordered 'D2 A-Causal' computational framework as embedded within the broader Computational Unified Field Theory.

As noted previously (Bentwich, 2011c), one of the three principle theoretical postulates underlying the CUFT is the computational 'Duality Principle' which constrains any 'Self Referential Ontological Computational System' (SROCS) of the general form:

$$PR\{x,y\} \rightarrow [y \text{ or } \text{'not } y\text{'}] / di1 \dots din$$

Indeed, it was shown (there) that Quantum Mechanics' probabilistic interpretation which is based on the assumption whereby the determination of the complimentary values of any subatomic 'target' element solely depends on its direct (or indirect) physical interaction with another 'probe' element (at the 'di1' to 'din' computational levels), thus:

$$SROCS: PR\{P, t\} \rightarrow [t \text{ or } \text{'}\neg t\text{'}] / di1 \dots n.$$

Likewise, Relativity's computational structure was also shown to constitute precisely such a SROCS computational structure:

$$\text{SROCS: PR}\{P, \text{Odiff}\} \rightarrow [P \text{ or } \neg P] / \text{di1...din}$$

wherein it is assumed that the determination of the "existence" or "non-existence" of any (specific) relativistic 'Phenomenon' (e.g., 'spatial-temporal' or 'energy-mass') is solely based on that Phenomenon's direct (or indirect) physical interaction with a differential series of relativistic observer/s.

Moreover, it was shown that both of these quantum and relativistic SROCS paradigms also necessarily contain the "negative" case of a 'Self-Referential Ontological *Negative* Computational System' (SRONCS) which inevitably leads to 'logical inconsistency' and ensuing '*computational indeterminacy*' - i.e., a principle *computational inability* of such a SROCS/SRONCS computational structure to *determine* whether any particular (quantum) 't' or (relativistic) 'P' value- "*exists*" or "*doesn't exist*"; However, since in both of these (quantum and relativistic) cases there is robust empirical data indicating the *capacity* of these quantum or relativistic computational systems to determine the "existence" or "non-existence" of any such particular 't' or 'P' value/s, then the (novel) computational '*Duality Principle*' asserted the *conceptual inability to compute* the "existence" or "non-existence" of any (particular) relativistic "P" or quantum "t" value *from within their direct physical interaction with another relativistic (differential) observer/s or with another subatomic 'probe' element* - but only from a conceptually higher-ordered 'D2' computational level which is irreducible to any direct (or indirect) physical interactions between any such quantum 'probe-target' or relativistic 'observer-Phenomenon' interactions;

Indeed, according to this new hypothetical computational 'Duality Principle', the only possible determination of any such quantum or relativistic relationships can be carried out based on such conceptually higher-ordered 'D2' computation which computes the "co-occurrences" of any relativistic ('spatial-temporal' or 'energy-mass') 'observer-Phenomenon' values, or the "co-occurrences" of any quantum (computational) complimentary ('spatial-energetic' or 'temporal-mass') 'probe-target' values... In fact, based on the identification of such a (singular) conceptually higher-ordered 'D2 A-Causal' computational framework which underlies both quantum and relativistic models of physical reality the (hypothetical) 'Computational Unified Field Theory' (CUFT) was hypothesized which postulated the existence of a series of extremely rapid 'Universal Simultaneous Computational Frames' (USCF's) that give rise to all quantum and relativistic physical phenomena (and may also point at new hypothetical critical physical predictions as described above which may arise from the discovery of the singular 'Universal Computational Principle' which computes this rapid series of USCF's).

More generally, the incorporation of the computational 'Duality Principle' as one of the three central postulates of the 'Computational Unified Field Theory' (CUFT) has pointed at the possibility that to the extent that other (key) scientific paradigms may also constitute such SROCS computational structures, then they should also be constrained by the 'Duality Principle' and the CUFT (e.g., of which the Duality Principle forms an integral part). Specifically, it was suggested that there may exist a series of key scientific paradigms (including: Darwin's Natural Selection Principle and associated 'Genetic Encoding' hypothesis and Neuroscience's basic 'materialistic-reductionistic' Psycho-Physical Problem) which may all comprise such basic SROCS computational structure, and therefore may be constrained by the 'Duality Principle'; Again, to the extent that each of these key scientific

(computational) paradigm may be shown to constitute a SROCS structure and therefore be constrained by the Duality Principle, then these scientific paradigms will have to be reformulated based on the Duality Principle's conceptually higher-ordered 'D2 a-causal' computational framework – thereby becoming an integral part of the CUFT's delineation of the 'D2' rapid series of the USCF's...

Therefore, what follows is a delineation of the SROCS computational structure underlying each of these key scientific paradigms – which shall therefore inevitably point at the Duality Principle's assertion regarding the (conceptual) impossibility of determining the "existence" or "non-existence" of any SROCS' (particular) 'y' element from within its direct or indirect physical (or computational) interaction with any exhaustive series of 'x' factor/s (e.g., that are particular to that specific SROCS scientific paradigm); Instead, the application of the Duality Principle to each of these scientific SROCS paradigms may point at the existence of a conceptually higher-ordered 'D2' computational framework which computes an 'a-causal' "co-occurrence" of a series of 'x-y' pairs (e.g., which alone can explain the empirical capacity of these scientific paradigms to determine the "existence" or "non-existence" of any particular 'y' element);

According to the hypothesized computational Duality Principle (Bentwich, 2011c), any empirical scientific paradigm that is based on such a SROCS computational structure may inevitably lead to both 'logical inconsistency' and 'computational indeterminacy' that are contradicted by that (particular) scientific paradigm's empirically proven capacity to determine whether any specific 'y' element "exists" or "doesn't exist"; This empirically proven capacity of the given scientific paradigm to compute the "existence" or "non-existence" of the 'y' element points at the Duality Principle's asserted conceptually higher-ordered 'D2' computational framework which computes the "co-occurrences" of any (hypothetical) series of [$x-y(st-i)$; ... $x-y(st-i+n)$] pairs; Indeed, this conceptually higher-ordered computation of the "co-occurrence" of any such 'x-y' pairing (proven by the Duality Principle) was termed: '**D2 A-Causal Computation**'. This is due to the fact that according to the Duality Principle the only possible means through which these empirically validated scientific paradigms are able to compute the "existence" or "non-existence" of any given 'y' element is through a conceptually higher-ordered 'D2 a-causal' Computation which determines the "co-occurrences" of any 'x-y' pair/s (e.g., but which was principally shown to be irreducible to any hypothetical direct or even indirect 'x-y' physical interactions)...

Indeed, as shown in the previous article (Bentwich, 2011c), since the Duality Principle's constraint of the SROCS computational structure is *conceptual* in nature – e.g., in that any SROCS computational structure is bound to produce both logical inconsistency and subsequent computational indeterminacy (e.g., which are contradicted by empirical evidence indicating the capacity of their corresponding computational systems to determine whether the particular 'y' element "exists" or "doesn't exist"), then it was shown that the Duality Principle's assertion regarding the need to place the computation of the "existence" or "non-existence" of the particular 'y' element at a conceptually higher-ordered 'D2' level overrides (and transcends) any direct or indirect physical relationship between the 'y' and 'x' elements (e.g., occurring at any hypothetical exhaustive computational level/s, 'di1...din'). This is because even if we assume that the computation determining whether the 'y' element "exists" or "doesn't exist" takes place at an intermediary (second) 'di2' computational level (or factor/s), then this does not alter the basic computational (causal-physical) SROCS structure; This is due to the basic materialistic-reductionistic working hypothesis underlying all key scientific SROCS paradigms wherein the sole determination of the "existence" or "non-existence" of the (particular) 'y' element is determined solely based on the direct

physical interaction between the 'y' element – e.g., as signified by the “causal-arrow” within the (above mentioned) SROCS computational structure: SROCS: $PR\{x,y\} \rightarrow [y \text{ or } \neg y]/di1$. Thus, whether we attribute the computation of the “existence/non-existence” of the 'y' element as taking place at the same 'direct physical interaction' (e.g., of the 'x' and 'y' elements at the 'di1' computational level) or whether we attempt to 'rise higher' to an additional hypothetical computational level/s (or factor/s etc.) the basic 'materialistic-reductionistic' assumption underlying the SROCS computational structure inevitably ties the direct physical 'x-y' interaction with a 'causal-material' determination of the “existence” or “non-existence” of the (ensuing) 'y' element (e.g., occurring either at the 'di1' or 'di2' computational levels). In other words, whether we assume that the determination of the 'existence/non-existence' of the 'y' element takes place at the same (di1) computational level as the direct physical 'x-y' interaction or whether we assume that the determination of the “existence”/“non-existence” of the 'y' element occurs (e.g., somehow) through one or more intermediary computational levels (di2...din) or factor/s the basic SROCS computational structure which assumes that it is this direct physical interaction between the 'x' and 'y' element which solely can determine whether the 'y' element “exists” or “doesn't exist” is therefore inevitably constrained by the computational Duality Principle:

Moreover, the Duality Principle's computational constraint asserts the conceptual inability to determine whether the (particular) 'y' element “exists” or “doesn't exist” from *within* any direct or indirect *physical interaction* between that 'y' element and any other 'x' factor (at any 'di1... 'din' computational levels), but *only from a conceptually higher-ordered 'D2' computational framework* which can only determine an 'a-causal' computational relationship/s between any hypothetical 'x' and 'y' factor/s; Indeed, as shown in the previous article (and noted above), such conceptually higher-ordered 'a-causal D2' computation cannot (in principle) be reduced to any direct or indirect physical 'x-y' interactions but instead involves an association of a series of 'x-y' pairs occurring at different 'spatial-temporal' points, thus: D2: $\{[x1, y1]st1; [x1, y1]st2 \dots [xn, yn]stn\}$. In other words, the (novel computational) Duality Principle effectively constrains- and replaces- any scientific SROCS paradigm (e.g., of the general form: SROCS: $PR\{x,y\} \rightarrow [y \text{ or } \neg y]/di1$) – with a conceptually higher-ordered 'D2' computational framework of the form: D2: $\{[x1, y1]st1; [x1, y1]st2 \dots [xn, yn]stn\}$ which is based on the (higher-ordered 'D2') computation of the co-occurrences of certain $\{x-y\}sti\dots n$ pairs (occurring at different spatial-temporal points). Indeed, it is suggested that such higher-ordered D2 computational metamorphosis replaces (and transcends) the strict materialistic-reductionistic working hypothesis underlying the current SROCS' scientific paradigm's focus with a conceptually higher-ordered 'non-material', 'non-causal' associative computational mechanism. Therefore, based on the Duality Principle's (above) computational-empirical proof for the basic computational constraint imposed on any scientific SROCS paradigm – e.g., which must necessarily be replaced by an alternative conceptually higher-ordered 'a-causal D2' computation, then any (existing or new) scientific paradigm that can be accurately demonstrated to replicate the (above mentioned) SROCS computational structure must be replaced by the Duality Principle's asserted conceptually higher-ordered 'D2' computational framework: D2: $\{[x1, y1]st1; [x1, y1]st2 \dots [xn, yn]stn\}$.

3.1 Darwin's natural selection principle & genetic encoding hypothesis

We therefore first examine the key scientific paradigms of Darwin's '*Natural Selection Principle*' (Darwin, 1859) (e.g., and its closely related 'Genetic Encoding' and 'Protein

Synthesis - Genetic Expression' hypotheses) in order to show that they all (in fact) constitute such 'Self-Referential Ontological Computational System' (SROCS) computational paradigms which are necessarily constrained by the computational 'Duality Principle'; In a nutshell, it is hypothesized that Darwin's evolutionary theory comprises three (intimately linked) scientific SROCS paradigms which are: the (primary) 'Natural Selection' SROCS, the (secondary) 'Genetic Encoding' (plus associated random mutations assumption) SROCS, and (tertiary) Protein Synthesis (phenotype) - Genetic Expression SROCS computational paradigms;

- i. **Natural Selection SROCS:** Darwin's 'Natural Selection' principle comprises a SROCS paradigm since it asserts that the "existence" or "non-existence" of any given organism (e.g., 'o' - and by extension, also all of its potential descendent organisms constituting a single specie) is solely dependent upon its direct (or indirect) physical interaction with an exhaustive series of 'Environmental Factors' ('E_{1...n}')

SROCS I {Natural Selection}: PR{ E_{1...n}, o } → ['o' or '¬o']/di1.

But, as we've seen (above), such SROCS computational structure inevitably leads to both 'logical inconsistency' and 'computational indeterminacy' - in the case of the SRONCS: PR{ E_{1...n}, o } → '¬o'/di.

This is because such a SRONCS asserts that the direct physical interaction between a given organism and an (exhaustive series of) Environmental Factors gives rise to the "non-existence" of that organism, which essentially implies that that particular organism both "exists" and "doesn't exist" at the same 'di1...din' computational level - which obviously constitutes a 'logical inconsistency'. But, due to the SROCS/SRONCS computational structure (e.g., which assumes that the only means of determining whether the organism "exists" or "doesn't exist" is through the direct physical interaction 'di1' between the organism and its exhaustive Environmental Factors), then such 'logical inconsistency' inevitably also leads to 'computational indeterminacy' - i.e., a principle inability of the SROCS/SRONCS scientific paradigm to determine whether that organism ('o') "exists" or "doesn't exist"! However, since there exists ample empirical evidence indicating the *capacity* of evolutionary biological systems to determine whether any given organism ('o') "exists" (e.g., survives) or "doesn't exist" (e.g., is extinct), then the Duality Principle asserts the conceptual computational inability of Darwin's Natural Selection principle to determine whether any given organism "exists" or "doesn't exist" based on its (strictly) assumed materialistic-reductionistic SROCS/SRONCS computational structure (e.g., direct physical interaction between the organism and an exhaustive set of Environmental Factors); Instead, the computational Duality Principle asserts that the only means for determining the evolution of any given biological species is based on a conceptually higher-ordered 'D2' computational framework which computes the "co-occurrences" of a series of any (hypothetical) organism/s and corresponding Environmental Factors, thus:

D2: [{E_{1...n}, o}st₁; {E_{1...n}, o}st₂ ... [{E_{1...n}, o}st_n].

Note that as in the above mentioned generalized format of the SROCS computational structure (e.g., PR{x,y}→['y' or '¬y']/di1), the computational constraint imposed by the Duality Principle is *conceptual* - i.e., it applies regardless of whether we're dealing with any 'direct' or 'indirect' physical relationships between the 'x' and 'y' factor/s; In the same manner, we can see that even if we assume that the interaction between any given organism

('o') and any exhaustive hypothetical Environmental Factors ('E{1...n}') comprises more than one Environmental Factor/s ('E{1...n}') or more than one (intermediary) computational level/s, the computational *structure* of Darwin's 'Natural Selection' SROCS paradigm inevitably leads to both 'logical inconsistency' and 'computational indeterminacy'; This is due to the fact that the fundamental 'materialistic-reductionistic' working hypothesis underlying the Natural Selection SROCS paradigm unequivocally stipulates that the determination of the "existence" or "non-existence" of any given organism ('o') is solely (and strictly) computed based on the direct (or even indirect) physical interaction/s between the organism and any exhaustive hypothetical series of Environmental Factors. Therefore, even if we assumed that Darwin's Natural Selection principle involves multiple Environmental Factors ('E{1...n}') and/or multiple computational levels ('di1'... 'diz'), thus:

$$\text{PR}\{ E_{\{1...n\}}, o\} / di1...din \rightarrow ['o' \text{ or } '\neg o'] / diz$$

then it still (inevitably) replicates the same SROCS computational structure that invariably produces the above mentioned 'logical inconsistency' and 'computational indeterminacy' (which give rise to the Duality Principle's above mentioned computational constraint). This is due to the fact that regardless of the number of (hypothetical) intervening (or mediating) Environmental Factors or computational level/s ('di1'...'diz'), the SROCS strict 'materialistic-reductionistic' computational structure assumes that the determination of the "existence" or "non-existence" of the organism is solely determined based on the direct physical interaction between the organism and its Environmental Factors.

Likewise, even if we assume that Darwin's Natural Selection process operates via innumerable organism-environment interactions taking place at different 'spatial-temporal' points {st1...stn}, then due to the (abovementioned) 'materialistic-reductionistic' implicit assumption embedded within the SROCS/SRONCS computational structure (i.e., which assumes that the "existence" or "non-existence" of the organism 'o' is *solely determined* based on any direct or indirect physical interactions between that organism and an exhaustive set of Environmental Factors), this does not alter the basic SROCS/SRONCS computational structure which was shown (above) to be constrained by the Duality Principle:

$$\text{PR}\{ E_{\{1...n\}}, o\} / sti1...sti \rightarrow ['o' \text{ or } '\neg o'] / stn / di1... diz$$

Essentially, this Natural Selection (primary) SROCS computational structure asserts that the determination of the "existence" or "non-existence" of any particular organism ('o') is solely determined based on its single- or multiple- spatial-temporal interactions with an exhaustive set of Environmental Factors (and even that hypothetically the actual computation or determination of the "existence" or "non-existence" of the particular organism {o} may take place at a later spatial-temporal point than the actual direct or indirect physical interaction between the organism and the exhaustive set of Environmental Factors);

Note, however, that this basic SROCS/SRONCS computational structure embeds within it the fundamental 'materialistic-reductionistic' implicit assumption wherein there cannot be any other factor/s outside the direct (or indirect) physical interaction/s between the organism and the (exhaustive set of) Environmental Factors which determines or computes the "existence" (e.g., survival) or "non-existence" (e.g., extinction) of that organism; This strong (implicit) 'materialistic-reductionistic' assumption underlying the SROCS/SRONCS computational structure is represented by the **causal** '→' connecting between the direct (or

indirect) physical interaction between the organism and the Environmental factors and the determination of the "existence"/"non-existence" of the particular organism... Therefore, based on this strict 'materialistic-reductionistic' assumption underlying Darwin's Natural Selection SROCS paradigm -the direct (or indirect) physical relationship between the organism and its Environmental Factors and its (strict) *causal effect* in determining the "existence" or "non-existence" of that organism must necessarily constitute a *singular computational level* (e.g., di1...dix), regardless of the number of (hypothetical) spatial-temporal points that occupy either the direct or indirect 'organism-Environmental Factors' interaction/s or the specific spatial-temporal point/s at which the determination (or computation) of the "existence" or "non-existence" of the organism take place!

Therefore, from a purely computational standpoint, both the direct physical interaction between the organism and its Environmental Factors (at 'di1') and the determination of the ensuing "existence" or "non-existence" of that organism (e.g., assumed to take place at any hypothetical level 'di1'...'diz') - must be considered to occur at the *same computational level* (e.g., at either 'di1'...'diz')! Indeed, it is precisely this materialistic-reductionistic SROCS/SRONCS paradigmatic structure which assumes that the determination of the "existence" or "non-existence" of the particular organism occurs at the *same computational level* (e.g., at either 'di1'...'diz') as the direct physical interaction between that organism and an exhaustive set of Environmental Factors which was shown (above) to inevitably lead to both 'logical inconsistency' and 'computational indeterminacy', which were shown to be contradicted by robust empirical findings - thereby pointing at the Duality Principle's assertion regarding the need for a conceptually higher-ordered 'D2' computational level that can compute the "co-occurrences" of any spatial-temporal pairing of any given organism and its corresponding Environmental Factors:

$$D2: \{ \{E\{1...n\}, o\}st1; \{E\{1...n\}, o\}st2 \dots \{E\{1...n\}, o\}stn \}.$$

Hence, based on the Duality Principle's logical-empirical analysis of the SROCS/SRONCS computational structure underlying Darwin's Natural Selection scientific paradigm, the Duality Principle has proven the conceptual computational inability to determine the "existence" or "non-existence" of any (hypothetical) organism based on any direct or indirect physical interaction/s between that organism and any (hypothetical) exhaustive set of Environmental Factor/s (at the same di1...dix computational level)- but only from a conceptually higher-ordered 'D2' computational level which simply computes the "co-occurrences" of any hypothetical series of spatial-temporal 'organism-Environmental Factors' pairing...

It is also worthwhile to note that the Duality Principle's proof for the conceptual computational inability of Darwin's Natural Selection Principle's SROCS computational structure to determine the "existence" or "non-existence" of any (hypothetical) organism ('o') from within its direct or indirect physical interaction within any (hypothetical) exhaustive series of Environmental Factors (e.g., at any 'di1... dix' computational level) also *negates* the existence of any "*causal-material*" relationship between the particular organism and any (exhaustive set of) Environmental Factors; This was previously shown (Bentwich, 2011c) through a thorough analysis of the Duality Principle's proof for the existence of a D2 'A-Causal' computational characteristics - which replaces the SROCS (implicit) 'material-causal' relationship between any two (hypothetical) 'x' and 'y' elements (e.g., at any di1...din computational level) with the D2's computation of the "co-occurrences" of any (hypothetical) series of 'x-y' pairs. The Duality Principle's conceptual proof for the principle inability of any

(exhaustive series of) Environmental Factors to *causally* determine the "existence" or "non-existence" of any particular organism based on any hypothetical single- or multiple- level/s of computation or single- or multiple- spatial-temporal points was also shown (above) based on the Duality Principle's proof for the basic (implicit) material-causal assumption underlying the SROCS computational structure which inevitably leads to both 'logical-inconsistency' and 'computational indeterminacy' which are contradicted by robust empirical evidence (e.g., indicating the *capacity* of evolutionary-biological systems to determine the "existence" or "non-existence" of any particular organism). Hence, a key emerging property of the Duality Principle (e.g., in this case as it applies to Darwin's Natural Selection SROCS paradigm) is that it replaces the basic (implicit) **material-causal** assumption embedded within the SROCS computational structure with a *conceptually higher-ordered* **'D2 A-Causal' computational framework** which merely computes the "*co-occurrences*" of any (hypothetical) series of '*organism-Environmental Factors*' pairs - i.e., but which cannot (in principle) possess any 'material-causal' relationship between them...

Interestingly though (as noted above), despite the Duality Principle's conceptual computational proof that Darwin's Natural Selection Principle (computational structure) constitutes a SROCS and is therefore constrained by the Duality Principle, i.e., indicating the conceptual computational inability to determine the "existence" or "non-existence" of any (hypothetical) organism ('o') based on any of its direct or indirect material-causal interaction/s with any exhaustive set of Environmental Factors $E\{1\dots n\}$ (but only from a conceptually higher-ordered 'D2 a-causal' computational framework) - it seems that Darwin's evolutionary theory further contingents Darwin's Natural Selection Principle's SROCS paradigm upon two other (hierarchical-dualistic) SROCS paradigms, i.e., the (abovementioned) 'Genetic Encoding' hypothesis and 'Protein Synthesis' SROCS paradigms;

ii. Organism Phenotype - Genetic Encoding SROCS: It is hypothesized that Darwin's (above mentioned) Natural Selection SROCS paradigm is anchored in- and based upon an additional (secondary) '*Organism Phenotype - Genetic Encoding*' SROCS paradigm:
 $PR\{G\{1\dots n\}, o\text{-}phi\} \rightarrow ['o\text{-}phi' \text{ or } '\neg o\text{-}phi'] / di1\dots din.$

wherein the "existence" or "non-existence" of any particular phenotypic property of any given organism ('o-phi') (e.g., appearing in Darwin's Natural Selection primary SROCS paradigm) is assumed to be solely determined based on its direct (or indirect) physical interaction/s with any exhaustive set of Genetic factors (e.g., at the 'di1...din' computational levels). Note that from the (entire) dualistic relationship existing between the 'organism' and the Environmental Factors in Darwin's Natural Selection Principle SROCS paradigm - only the 'organism ('o') element is utilized within the secondary '*Organism Phenotype - Genetic Encoding*' SROCS paradigm:

$$PR\{G\{1\dots n\}, o\text{-}phi\} \rightarrow ['o\text{-}phi' \text{ or } '\neg o\text{-}phi'] / di1\dots din.$$

In other words, the "existence" or "non-existence" of any particular organism possessing a specific phenotypic property is totally contingent upon its direct (or indirect) physical interaction with an exhaustive series of relevant Generic factors; It is to be noted that the implicit assumption underlying this 'hierarchical-dualistic' computational structure is the (tacit) contingency that exists between Darwin's (primary) Natural Selection Principle's *organism's particular phenotypic property* (e.g., which interacts directly or indirectly with the exhaustive set of Environmental Factors, thereby solely determining the "existence" or "non-existence" of that particular organism) - and the exhaustive set of relevant Genetic Factors which together (solely) determine the "existence" or "non-existence" of that particular

phenotypic property! Thus, it may be said that there exists a dual 'hierarchical-dualistic' computational structure which constitutes Darwin's entire evolutionary theory that can be broken down to two interrelated SROCS computational structures, thus:

$$\text{SROCS I \{Natural Selection\}: PR\{E_{\{1..n\}}, 'o-phi' \} \rightarrow ['o-phi' \text{ or } ' \neg o-phi']/ di1.}$$

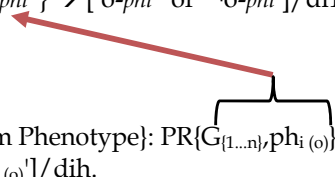
$$\text{SROCS II \{Genetic Encoding - Organism Phenotype\}: PR\{G_{\{1..n\}}, phi_{(o)} \} \rightarrow ['phi_{(o)}' \text{ or } ' \neg phi_{(o)}']/ dih.}$$

However, to the extent that it can be proven that this (secondary) 'Genetic Encoding - Organism Phenotype' computational structure replicates and constitutes a SROCS computational structure, then it automatically follows that both the primary and secondary SROCS paradigms comprising Darwin's (currently accepted) evolutionary theory must be replaced (and transcended) by a conceptually higher-ordered 'D2' computational framework; Thus, we now set to evince that Darwin's (secondary) Genetic Encoding- Organism's Phenotype computational structure constitutes a SROCS paradigm and is therefore also necessarily constrained by the (same) computational Duality Principle:

$$\text{PR}\{G_{\{1..n\}}, phi_{(o)}\} \rightarrow ['phi_{(o)}' \text{ or } ' \neg phi_{(o)}']/ dih.$$

As shown above, this computational structure precisely replicates the generalized SROCS structure of the form: $\text{PR}\{x,y\} \rightarrow ['y' \text{ or } ' \neg y']$, which was shown to inevitably lead to both 'logical inconsistency' and ensuing 'computational indeterminacy' in the case of the 'Self-Referential Ontological Computational System' (SRONCS).

This is simply because if it is assumed that the "existence" or "non-existence" of any particular phenotypic property ('phi (o)') is solely dependent upon its direct physical interaction with any exhaustive series of 'Genetic Factors' ('G{1..n}'), then in the case of the (abovementioned) SRONCS paradigm the specific phenotypic property 'phi (o)' appears to both "exist" and "not exist" at the same 'dih' computational level: $\text{PR}\{G_{\{1..n\}}, phi_{(o)}\} \rightarrow ' \neg phi_{(o)}' / dih$, which obviously produces a 'logical inconsistency' - which also inevitably leads to an (apparent) 'computational indeterminacy', e.g., an apparent inability of the computational system to determine whether that particular phenotypic property "exists" or "doesn't exist"... But, since there exist ample empirical evidence indicating that genetic (computational) system do in fact possess the capacity to determine whether any given phenotypic property 'phi (o)' "exists" or "doesn't exist" within a given organism, then we must conclude that the (currently assumed) SROCS computational structure is invalid!

As shown previously, it is important to note that the computational constraint imposed by the Duality Principle is *conceptual* in nature - i.e., it applies to any single- or multiple-hypothetical computational levels that may be involved in any direct or even indirect (e.g., *dih1...dihm*) physical interactions between the particular phenotypic property and any exhaustive series of 'Genetic Factors' (G{1..n});

As shown (above), the reason for this *conceptual* computational constraint imposed on the 'Genetic Encoding' SROCS by the Duality Principle stems from the existence of an implicit '*materialistic-reductionistic*' assumption embedded within the SROCS computational structure which is represented by the 'causal arrow' \rightarrow which connects between any direct physical interaction between the exhaustive set of 'Genetic Factors' and the particular phenotypic

property (at '*dih1*') and any single- or multiple- direct or indirect physical interactions or computational levels that may mediate between this direct 'Genetic Factors - phenotype' physical interaction (at *dihn*) and between the determination of the "existence" or "non-existence" of the particular (relevant) phenotypic property; Therefore it may be appropriate to represent the conceptual constraint imposed by the Duality Principle upon the (secondary) Genetic Encoding-phenotype SROCS structure in this manner:

$$PR\{G\{1\dots n\},\phi(o)\}di1 \rightarrow [\phi(o) \text{ or } \neg\phi(o)]dih1\dots dihn.$$

wherein any (hypothetical) direct or indirect physical interaction between an exhaustive set of Genetic Factors and the particular phenotypic property ' $\phi(o)$ ' - which can take place either at their direct physical interaction level ('*dih1*') or at any subsequent (indirect) computational level/s (e.g., '*dihn*') *causally leads* to the determination of the "existence" or "non-existence" of that particular phenotypic property ' $\phi(o)$ ' at a hypothetical '*dihz*' computational level; However, even for this (expanded) Genetic Factors - phenotypic property SROCS computational structure it becomes clear that the (abovementioned) 'materialistic-reductionistic' implicit assumption embedded within it - inevitably leads to both 'logical inconsistency' and subsequent 'computational indeterminacy' that are contradicted by robust empirical findings indicating the *capacity* of biological evolutionary systems to determine the "existence" or "non-existence" of any particular phenotypic property in any given organism... This is due to the fact that despite the hypothesis that the determination of the "existence" or "non-existence" of the particular phenotypic property may occur at (single- or multiple) computational level/s (*dih1... dihz*) that may be different than the direct physical interaction between the particular phenotype and the (exhaustive set of) Genetic Factors, due to the above mentioned 'materialistic-reductionistic' implicit assumption embedded within this (expanded) SROCS structure the determination of the "existence" or "non-existence" of that particular phenotypic property ' $\phi(o)$ ' is solely- and strictly- *caused* by the direct physical interaction between the (exhaustive set of) Genetic Factors (at *dih1*) and that phenotypic property ' $\phi(o)$ '; But, this implies that the determination of the "existence" or "non-existence" of the phenotypic property ' $\phi(o)$ ' takes place at the *same computational level/s* as the direct physical interaction level (*dih1...dihz*) between the Genetic Factors and the phenotypic property, which may be represented thus:

$$PR\{G\{1\dots n\},\phi(o)\} \rightarrow [\phi(o) \text{ or } \neg\phi(o)]/ dih1\dots dihz$$

which precisely replicates the above SROCS computational structure which has been shown to be constrained by the Duality Principle...

In other words, whether the interaction between the Genetic Factors and the phenotypic property takes place at the same computational level (e.g., at '*dih1*') as the determination of the "existence" or "non-existence" of the phenotypic property, or takes place at a different (single or multiple) computational level/s (e.g., '*dih1... dihz*') - due to the implicit materialistic-reductionistic assumption embedded within the (expanded) SROCS computational structure this inevitably leads to both 'logical inconsistency' which inevitably leads to both 'logical inconsistency' and 'computational indeterminacy' that were contradicted by empirical evidence and which therefore lead to the Duality Principle's assertion regarding the need for a conceptually higher-ordered 'D2' computational level which merely computes the "co-occurrences" of any hypothetically pairs of 'Genetic Factors - phenotypic property'.

In fact, the Duality Principle's conceptual computational proof for the principle inability to determine the "existence" or "non-existence" of any particular phenotypic property from within any direct or indirect (di1..diz) physical interaction between the Genetic Factors and the phenotypic property also includes any spatial-temporal span in which these direct or indirect physical interactions occur, or in which the determination of the "existence" or "non-existence" of the (particular) phenotypic property takes place; This can be seen if we formalize each of these direct or indirect physical interaction/s between the Genetic Factors and the particular phenotypic property- as well as to the determination of the "existence"/"non-existence" of the phenotypic property any (hypothetical) spatial-temporal value/s, thus:

$$\text{PR}\{G_{\{1..n\}}, \text{phi}(o)\}_{\text{st1..stj}} \rightarrow [\text{'phi}(o)' \text{ or } \text{'}\neg\text{phi}(o)\text{'}]_{\text{stn}} / \text{dih1...dihz}$$

Wherein the direct physical interaction between the (exhaustive set of) Genetic Factors and the particular phenotypic property takes place at either single- or multiple- time points (st1...stj) that may be different than the spatial-temporal point/s at which the determination of the "existence" or "non-existence" of the (particular) phenotypic property takes place (e.g., 'dih1...dihz'). This is because even if we assume that the spatial temporal points at which the direct physical interaction between these Genetic Factors and the particular phenotypic property (PR{G{1..n},phi(o)}st1..stj), and the determination of the "existence" or "non-existence" of the particular phenotypic property ['phi(o)' or '¬phi(o)']stn are different, then due to the (above generalized) SROCS' embedded 'materialistic-reductionsitic' causal assumption wherein the determination of the "existence" or "non-existence" of the particular phenotypic property is assumed to be determined strictly- and solely- based on the direct (or indirect) physical interaction between the Genetic Factors and that phenotypic property, then this (generalized) SROCS computational structure inevitably leads to both logical inconsistency and computational indeterminacy - which (in turn) point at the Duality Principle's (abovementioned) computational constraint...

We are thus forced to accept the Duality Principle's conceptual computational constraint imposed upon the 'Genetic Encoding - Phenotypic Property' (secondary) SROCS structure wherein the determination of the "existence" or "non-existence" of any particular phenotypic property (within any given organism) cannot (e.g., in principle) be determined from within any direct- or indirect- physical interaction between any exhaustive set of Genetic Factors and any hypothetical phenotypic property, or through any hypothetical single- or multiple- computational levels associated with these direct or indirect physical interaction/s or based on the same or different (single- or multiple-) spatial-temporal points (or intervals) at which these Genetic Factors may interact with any particular phenotypic property:

$$\text{PR}\{G_{\{1..n\}}, \text{phi}(o)\}_{\text{st1..stj}} \not\rightarrow [\text{'phi}(o)' \text{ or } \text{'}\neg\text{phi}(o)\text{'}]_{\text{stn}} / \text{dih1...dihz}.$$

As stated above, the conceptual computational proof for the Duality Principle's assertion arises from the inevitably 'logical inconsistency and 'computational indeterminacy' implications of the SRONCS computational structure wherein the particular phenotypic property seems to both "exist" and "not exist" at the same computational level (which not only constitutes an explicit 'logical inconsistency' but also produces an inevitable 'computational indeterminacy' that is contradicted by empirical findings indicating the capacity of genetic-biological computational systems to determine the "existence" or "non-existence" of any particular phenotypic property);

Instead, the Duality Principle asserts that there must exist a conceptually higher-ordered 'D2' computational framework which is capable of computing the "co-occurrences" of any hypothetical pair/s of Genetic Factor/s and any phenotypic property (e.g., existing at any spatial-temporal point/s):

$$D2: \{ \{G\{1\dots n\}, 'phi(o)'\}st_1; \{G\{1\dots n\}, 'ph_j(o)'\}st_i; \dots \{G\{1\dots n\}, 'ph_n(o)'\}st_n \}.$$

Therefore, the application of the computational Duality Principle to both Darwin's 'Natural Selection' (primary) SROCS computational paradigm, as well as to its (secondary) 'Genetic Encoding - Phenotypic Property' SROCS paradigm (e.g., which is assumed to serve as a contingency for the primary Natural Selection SROCS paradigm) has proven that it is not possible to determine the "existence" or "non-existence" of any 'organism'- or organism related 'phenotypic property' based on any direct- or indirect- physical interaction between any organism- and an exhaustive set of Environmental Factors or between any (organism's) phenotypic property and any exhaustive set of Genetic Factors e.g., including as carried out by single- or multiple- computational level/s, or taking place at any spatial-temporal point/s etc. Instead, the (novel) computational Duality Principle asserts that there exists a conceptually higher-ordered D2 computational level which computes the "co-occurrences" of any single or multiple hypothetical pairs of any exhaustive set of 'Environmental Factors' and any given 'organism' or of any exhaustive set of 'Genetic Factors' and any organism's 'phenotypic property', which may be represented in this manner:

$$D2: \{ \{E\{1\dots n\}, o\}st_1; \{E\{1\dots n\}, o\}st_2 \dots \{E\{1\dots n\}, o\}st_n \}.$$

$$D2: \{ \{G\{1\dots n\}, 'phi(o)'\}st_1; \{G\{1\dots n\}, 'ph_j(o)'\}st_i; \dots \{G\{1\dots n\}, 'ph_n(o)'\}st_n \}.$$

Finally, it is hypothesized that with the advent of modern genetics, RNA and mRNA scientific research one additional (hypothetical) SROCS computational paradigm has emerged which is the '*Genetic Encoding - Protein Synthesis*' (tertiary) SROCS paradigm; This is because the latest developments in genetics research (in general) and those related to the investigation of the relationships that exist between genetic encoding and protein synthesis (in particular) are based on the assumption wherein any biological synthesis of proteins comprising- and constructing- the biological organism are contingent upon a direct (or indirect) physical relationship between an exhaustive set of Genetic Factors and a certain protein synthesis agent, e.g., such as for instance a particular RNA or mRNA synthesis of a particular protein through their direct or indirect physical interaction with a given set of exhaustive Genetic Factors (Burgess, 1971; Geiduschek & Haselkorn, 1969; Khorana, 1965; Rich & Rajbhandary, 1976; Schweet, & Heintz, 1966).

Indeed, it is suggested that this hypothetical (direct or indirect) physical relationship between a certain exhaustive set of Genetic Factors and any (hypothetical) protein synthesis agent precisely reproduces the (above mentioned) tertiary 'Genetic Expression - Protein Synthesis' SROCS paradigm.

iii. **Protein Synthesis (phenotype) - Genetic Expression SROCS:** It is therefore hypothesized that both Darwin's (above mentioned 'primary') Natural Selection SROCS paradigm as well as the (secondary above mentioned) 'Genetic Encoding - Phenotypic Property' SROCS paradigms are anchored in- and contingent upon- a (tertiary) 'Phenotypic Expression - Protein Synthesis' SROCS computational paradigm, which assumes that the determination of the "existence" or "non-existence" of any particular

Protein (phenotype) is strictly- and entirely- dependent upon its direct (or indirect) physical interaction with an exhaustive set of Genetic Expression ;

**SROCS III {Genetic Expression - Protein Synthesis}: PR{G{1...n}, p-synth}
→ ['p-synth or '¬p-synth].**

we therefore obtain the full hierarchical-dualistic computational structure underlying Darwin's evolutionary theory as comprising of:

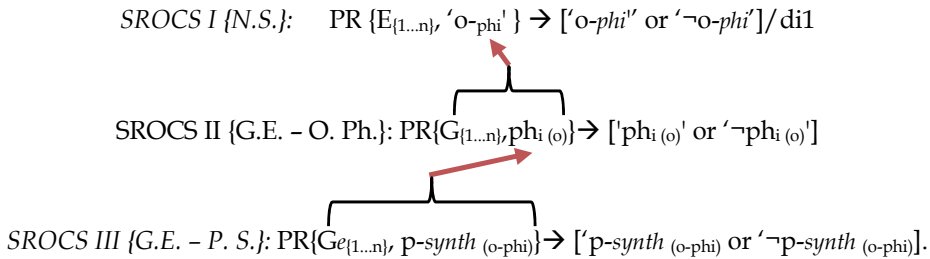

This (new) hypothetical hierarchical-dualistic computational structure underlying Darwin's evolutionary modeling is nevertheless constrained (i.e., at each and every one of its three layered SROCS scientific paradigms) by the *Duality Principle* which therefore forces us to replace each of these (three) SROCS computational levels with a conceptually higher-ordered singular 'D2' computation of the "co-occurrences" of multi-layered pairs of 'Environmental Factors - organism', 'Genetic Factors - (organism) Phenotype' and 'Genetic Expression - (organism-phenotype) Protein Synthesis'...

Based on the (above detailed) analysis of the Duality Principle's constraint of any (generalized) SROCS computational paradigm it is not necessary to repeat the details of the Duality Principle's conceptual computational proof for the inability of the (tertiary) 'Genetic Encoding - Protein Synthesis' SROCS to determine the "existence" or "non-existence" of any particular 'protein synthesis' based on its direct physical interaction with an exhaustive set of 'Genetic Expression'; Suffice to state that according to the (above generalized) conceptual computational proof of the Duality Principle, in the specific case of a SRONCS - i.e., in which any direct (or indirect) physical interaction/s between such (an exhaustive set of) Genetic Expression and any particular Protein Synthesis leads to the "non-existence" (e.g., 'non-synthesis') of any such particular protein, this produces the (abovementioned) 'logical inconsistency' and ensuing 'computational indeterminacy' which are contradicted by well-known empirical evidence indicating the *capacity* of biological-evolutionary systems to determine whether any particular protein is synthesized... As shown above, this leads to the Duality Principle's inevitable assertion regarding the existence of the conceptually higher-ordered 'D2' computational framework which computes the "co-occurrences" of any (hypothetical) series of 'Genetic Expression - Protein Synthesis' pairs occurring at any given spatial-temporal point/s in any given organism:

$$D2: [\{ Ge\{1...n\}, pi\text{-synth} (o\text{-phi}) \} st1; Ge\{1...n\}, pj\text{-synth} (o\text{-phi}) \} sti... ; Ge\{1...n\}, pn\text{-synth} (o\text{-phi}) \} stn]$$

Therefore, the Duality Principle's (abovementioned) constraint of the three ('Natural Selection', 'Genetic Encoding' and 'Protein Synthesis') SROCS computational paradigms (or

levels) has proven the conceptual computational inability of each of these scientific paradigms (or computational levels) to determine the "existence" or "non-existence" of the particular 'y' element (e.g., particular 'organism', particular 'phenotypic property', or particular 'protein synthesis') – from within any direct or indirect physical interaction between the (given) 'x' factor and an exhaustive set of the (abovementioned) 'x' factor/s; Instead, the Duality Principle evinced the existence of a conceptually higher-ordered 'D2' computational level which (alone) can compute the "co-occurrences" of any of these (three-leveled) 'x' and 'y' factors (e.g., at any given hypothetical spatial-temporal point/s or computational level/s etc.), thus:

$$D2: \{[E_{\{1\dots n\}}, o]st_1; [E_{\{1\dots n\}}, o]st_2 \dots [E_{\{1\dots n\}}, o]st_n\}.$$

$$D2: \{[G_{\{1\dots n\}}, \phi(o)]st_1; [G_{\{1\dots n\}}, \phi_j(o)]st_i; \dots [G_{\{1\dots n\}}, \phi_n(o)]st_n\}.$$

$$D2: \{[Ge_{\{1\dots n\}}, \text{pi-synth}(o-\phi)]st_1; Ge_{\{1\dots n\}}, \text{pj-synth}(o-\phi)]st_i \dots ; \\ Ge_{\{1\dots n\}}, \text{pn-synth}(o-\phi)]st_n\}$$

However, based on the previous (Bentwich, 2011c) conceptual proof for the *singularity* of the 'D2' computational framework forces us to accept the fact that there must be a (singular) simultaneous computation of all three-layered SROCS' "co-occurring" pairs (e.g., which according to the CUFT must comprise the same USCF frame/s):

$$D2: \{[E_{\{1\dots n\}}, o]st_1; [E_{\{1\dots n\}}, o]st_2 \dots [E_{\{1\dots n\}}, o]st_n\}.$$

$$D2: \{[G_{\{1\dots n\}}, \phi(o)]st_1; [G_{\{1\dots n\}}, \phi_j(o)]st_i; \dots [G_{\{1\dots n\}}, \phi_n(o)]st_n\}.$$

$$D2: \{[Ge_{\{1\dots n\}}, \text{pi-synth}(o-\phi)]st_1; Ge_{\{1\dots n\}}, \text{pj-synth}(o-\phi)]st_i \dots ; \\ Ge_{\{1\dots n\}}, \text{pn-synth}(o-\phi)]st_n\}$$

Along these lines it is suggested that based on the Duality Principle's proof for the existence of a conceptually higher-ordered 'D2' computational framework for each of the two (Darwin's 'Natural Selection' and 'Genetic Factors – Phenotypic Property') SROCS paradigms, and a previous (Bentwich, 2011c) conceptual proof for the singularity of such higher-ordered 'D2' computational framework we are led to conclude that :

- a. Darwin's evolutionary theory is based on a three-layered hierarchical-dualistic computational structure which consists of a primary 'Natural Selection' SROCS paradigm that is contingent upon a secondary 'Genetic Encoding – Phenotypic Property' SROCS paradigm that is (in turn) contingent upon a tertiary 'Genetic Expression – Protein Synthesis' SROCS computational paradigm...
- b. Each of these SROCS computational paradigms is constrained by a (generalized) 'Duality Principle' which asserts that it is not possible to determine the "existence" or "non-existence" of any (hypothetical) 'y' element based on any direct or indirect physical interaction of that 'y' element with any (exhaustive set of) 'x' factor/s; Instead, the Duality Principle postulates that it is only possible to determine the "co-occurrences" of any series of (hypothetical) 'x-y' pairs taking place at different spatial-

temporal point/s or interval/s as computed by a conceptually higher-ordered 'D2' computational framework that is (e.g., in principle) irreducible to any series of exhaustive hypothetical direct- or indirect- physical interaction/s, single- or multiple-computational level/s or any hypothetical series of spatial-temporal interactions or occurrences... and:

- c. That there can exist only *one singular* such higher-ordered 'D2' computational framework (e.g., as proven by the application of the Duality Principle to each and every one of these hypothetical SROCS paradigms); (Later on, it will be shown that this (hypothetical) singular conceptually higher-ordered 'D2' computational framework must be equivalent to the previously indicated (Bentwich, 2011c) Computational Unified Field Theory's (CUFT) rapid series of 'Universal Simultaneous Computational Frames' (USCF's) which may underlie all microscopic (quantum) and macroscopic (relativistic) aspects of the physical reality.)

Note (however) that the full theoretical implications of accepting these conceptual computational constraints imposed by the Duality Principle upon any scientific SROCS paradigm (in general) and particularly which are set upon Darwin's three-layered must necessarily replace all material-causal (direct- or indirect- single- or multiple-) interaction/s with an a-causal (conceptually higher-ordered) singular computational framework (e.g., termed: 'D2') which alone can compute an exhaustive series of 'x-y' pairs that occur at different spatial-temporal point/s or level/s; Specifically, in the case of Darwin's biological-evolutionary theory the application of the computational Duality Principle to the (above-mentioned) three-layered (primary 'Natural Selection', secondary 'Genetic Encoding - Phenotypic Property' and tertiary 'Genetic Expression - Protein Synthesis') SROCS paradigms, may have potentially far reaching theoretical implications:

Essentially, the acceptance of the Duality Principle's postulated singular conceptually higher-ordered 'D2' computation of the "co-occurrences" of an exhaustive series of 'x-y' pairs implies that all three ('Natural Selection', 'Genetic Encoding -Phenotypic Property', and 'Genetic Expression - Protein Synthesis') 'material-causal' scientific SROCS paradigms must be replaced by a singular (conceptually higher-ordered) 'D2' computation of the "co-occurrences" of each of these (triple-layered) 'Environmental Factors - organism', 'Genetic Factors - phenotypic property' and 'Genetic Expression - Phenotypic Property' computational pairs simultaneously!

It is to be noted that the (above) detailed analysis of the three-layered SROCS computational structure points at two important (specific and more generalized) theoretical implications:

First, in the specific case of Darwin's (three-layered hierarchical-dualistic) SROCS computational structure, it becomes evident that not only is each one of the three constituent SROCS paradigms constrained by the computational Duality Principle - which therefore points at the existence of a singular (conceptually higher-ordered) 'D2' computational framework that computes the "co-occurrences" of each of the (above-mentioned) 'Environmental Factors - organism', 'Genetic Factors - phenotype' and 'Genetic Expression - protein synthesis' pairs (at any given spatial-temporal point/s); but also, an examination of the computational inter-relationships that exist between these (three-layered) SROCS paradigms reveals that each such (subsequent) computational SROCS layer in effect further fragments one of the components of the physical interaction/s in the (previous) layered SROCS structure:

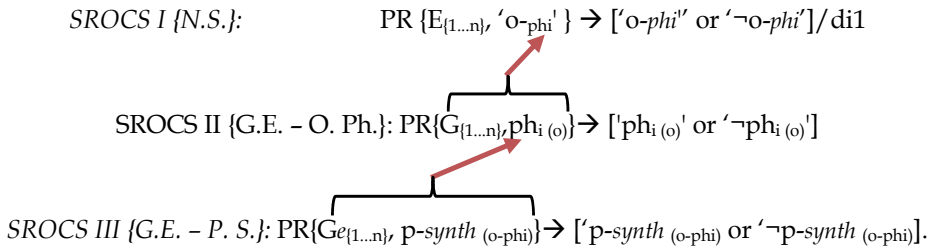

In fact, it is suggested that this hierarchical-dualistic computational structure underlying Darwin's evolutionary theory may point at a much more generalized 'Black-Box Hypothesis' (BBH) as underlying key materialistic-reductionistic (or "material causality" based) scientific paradigms; Indeed, before we attempt to further generalize this 'BBH' to other (key scientific) SROCS paradigms, we attempt to explicate the BBH in the case of these three-layered (above mentioned) SROCS computational structure: It was noted (above) that the inter-relationships between these three (layered) scientific SROCS paradigms is such that each subsequent computational leveled SROCS further fragments the previous level SROCS, i.e., further "de-composes" the previous level SROCS' 'y' element into two (or more) constituting factors; Thus, for instance, the 'y' element in Darwin's (primary) 'Natural Selection' SROCS which is the '*organism*' (e.g., which interacts directly or indirectly with the exhaustive set of Environmental Factors 'E_{1...n}'- in order to determine whether such '*organism*' shall exist/survive or not exist/gets extinct) - that '*organism*' is further "de-composed" or 'fragmented' into the direct physical interaction between the exhaustive set of 'Genetic Factors' G_{1...n} and a particular phenotypic property 'phi (o)' e.g., possessed by this particular organism; In other words, Darwin's (primary) Natural Selection SROCS' (direct or indirect) physical interaction between the organism and an exhaustive set of Environmental Factors is further decomposed in the secondary 'Genetic Encoding-Phenotype Property' SROCS computational structure into (two) sub-set fragments of the organism - i.e., which are assumed to consist of a (direct or indirect) physical interaction/s between the exhaustive set of Genetic Factors and (relevant) phenotype property (which is determined to "exist" or "not exist" based on this direct or indirect Genetic Factors - property interaction).

Hence, the secondary (Genetic Encoding - phenotype property) SROCS computational structure further decomposes one of the elements within the primary (Natural Selection) SROCS paradigm, i.e., the '*organism*' ('y') element - into two interacting elements within the secondary (Genetic Encoding - phenotype property) SROCS paradigm, e.g., the exhaustive set of Genetic Encoding and a particular phenotypic property:

However, a closer application of the computational Duality Principle (in the case of this dual hierarchical-dualistic computational structure) indicates that not only is each one of these (inter-related) SROCS paradigms constrained by the Duality Principle; but it is also shown that the further fragmentation of the '*organism*' element found in the primary (Natural Selection) SROCS paradigm - into the 'Genetic Encoding' (exhaustive set) and 'phenotype property' physical relationship in the secondary (Genetic Encoding - phenotype property) SROCS structure in effect does not alter the basic computational structure found in the primary SROCS paradigm: This is because both the Genetic Encoding exhaustive set and the (particular) phenotype property - are necessarily *included* within the organism (e.g., and its particular phenotype property expressed as: '*o-phi*') within the primary ('Natural Selection') SROCS paradigm!

So, we can see that the initial ('generalized') SROCS computational structure:

$PR\{E\{1\dots n\}, 'o\text{-}phi'\} \rightarrow ['o\text{-}phi'$ or $'\neg o\text{-}phi']/di1$ already contains within it any further (secondary) SROCS computational paradigms such as for instance the 'Genetic Encoding - phenotype property' SROCS paradigm; This is because the organism element within the primary SROCS paradigm (represented as: $'o\text{-}phi'$) already contains any further segmentation or fragmentation - i.e., as consisting of the Genetic Encoding and phenotype property (direct or indirect) physical interaction/s. Indeed, if we wish to represent the basic (generalized) SROCS computational structure as: $PR\{X\{1\dots n\}, Y\{1\dots n\}\} \rightarrow ['y'$ or $'\neg y']$ then any potential (further) breakdown or fragmentation of the $Y\{1\dots n\}$ element is bound to be contained within the (original) generalized SROCS computational structure and therefore bound to be constrained by the computational Duality Principle.

In the specific case of Darwin's evolutionary theory - the generalized (above mentioned) SROCS computational structure may be represented by the (primary) 'Natural Selection' SROCS structure, thus:

SROCS I [N.S.]: $PR\{E\{1\dots n\}, 'o\text{-}phi'\} \rightarrow ['o\text{-}phi'$ or $'\neg o\text{-}phi']/di1$ which precisely replicates the (above mentioned) generalized SROCS structure of: $PR\{X\{1\dots n\}, Y\{1\dots n\}\} \rightarrow ['y'$ or $'\neg y']$; indeed, the further fragmentation of this basic (generalized-primary) SROCS computational structure into the secondary 'Genetic Encoding - Phenotype Property' and tertiary 'Genetic Factors - Protein Synthesis' SROCS computational does not alter the basic (generalized) SROCS computational structure (which is obviously constrained by the computational Duality Principle); This is because any further breakdown of the organism ($Y\{1\dots n\}$) factor (e.g., within the basic SROCS generalized structure) - i.e., into the 'Genetic Factors' and 'Phenotype Property' [e.g., $PR\{G\{1\dots n\}, phi(o)\}$] or into the 'Genetic Encoding' and 'Protein Synthesis' relationship [e.g., $PR\{Ge\{1\dots n\}, p\text{-}synth(o\text{-}phi)\}$] - obviously does not alter the basic (generalized) SROCS relationship between the organism (e.g., and all of its related phenotypic, genetic, protein... etc. factors) and its Environmental Factors!

More generally, we can see that any scientific SROCS paradigm which consists of the generalized format: $PR\{X\{1\dots n\}, Y\{1\dots n\}\} \rightarrow [Y\{1\dots n\}$ or $'Y\{1\dots n\}']/di1$ is not altered by any further breakdown (or fragmentation of the $Y\{1\dots n\}$ element; Indeed, it is hypothesized that the BBH precisely constitutes such an explicit fragmentation of the basic SROCS computational structure (e.g., $PR\{X\{1\dots n\}, Y\{1\dots n\}\} \rightarrow [Y\{1\dots n\}'$ or $'Y\{1\dots n\}']/di1$) into further and further computational relationships - which are nevertheless comprised within the $PR\{X\{1\dots n\}, Y\{1\dots n\}\}$ basic SROCS computational structure which has already been shown to be constrained by the computational Duality Principle. Indeed, the abovementioned conceptual computational proof may point at the generalization of the Duality Principle which points at the fallacy of the 'Black Box Hypothesis' - i.e., wherein it becomes clear that the Duality Principle's basic computational constraint imposed upon any (generalized) SROCS paradigm remains unaltered regardless of how many further fragmentations, subdivisions or computational levels ($di1\dots din$) the original 'y' element is comprised of- or divided into-...

Thus, it seems that the generalized form of the Duality Principle may point at the basic fallacy of the 'Black Box Hypothesis' (BBH) - i.e., proving that regardless of the number of factors- or computational levels- that any hypothetical SROCS is fragmented (or broken down into), any such (original) SROCS is necessarily (still) constrained by the Duality Principle; This means that the Duality Principle proves the conceptual computational inability of any such (single- or multiple- leveled) SROCS structure to determine the "existence" or "non-existence" of any hypothetical 'y' element from within its direct or

indirect physical relationship/s with any exhaustive 'X-series' (e.g., at any 'di1...din computational level contained within this original SROCS computational structure):

$$\text{SROCS: PR}\{X_{1\dots n}, y\} \rightarrow [y' \text{ or 'not } y']$$

But, if indeed the generalized form of the Duality Principle can prove that any (single- or multiple- level) SROCS computational structure is constrained by the Duality Principle, then this means that for any such scientific SROCS paradigm (e.g., for which it is known that the given computational system is *capable* of determining whether a given 'y' element "exists" or "doesn't exist" - there must exist a conceptually higher-ordered 'D2' computational level at which there is an 'a-causal' computation yielding the identification of (single- or multiple-) pairs of 'x' and 'y' factors (e.g., occurring at different spatial-temporal point/s, interval/s etc.). This is because the (generalized) Duality Principle has already proven that assuming that the determination of the "existence" or "non-existence" of any given 'y' element from *within* its direct physical interaction with another X(1...n) factor/s inevitably leads to both 'logical inconsistency' and 'computational indeterminacy' - which are (once again) contradicted by robust empirical findings. Moreover, it was shown earlier that the computational characteristics of such D2 level involves an 'a-causal' computation, which computes the "co-occurrences" of any (exhaustive hypothetical) series of 'x-y' pairs (occurring at any hypothetical spatial-temporal point/s or intervals etc.).

Indeed, in the above mentioned case of Darwin's tertiary SROCS computational structure e.g., (comprised of the primary 'Natural Selection Principle, which was further fragmented into the secondary 'Genetic Factors - Phenotypic Property' SROCS paradigm and finally further broken down into the third level 'Genetic Encoding - Protein Synthesis' SROCS paradigm) - the generalized Duality Principle proof pointed at the fallacy of the (tertiary leveled) 'BBH'; Instead, the (generalized) Duality Principle points at the existence of a conceptually higher-ordered 'D2' computational level which carries out computation yielding the (simultaneous) "co-occurrences" of all of the above mentioned three leveled 'x-y' pairs series: Specifically, it is suggested that in the case of Darwin's evolutionary theory an adoption of the Duality Principle's singular D2 computational level indicates that all (abovementioned) apparent tertiary SROCS computational paradigms need to be replaced by three (corresponding) series of 'x-y' pairs (e.g., Environmental Factors - organism; Genetic Factors - Phenotypic Properties; Genetic Encoding - Protein Synthesis)...

This means that in the specific instance of Darwin's evolutionary theory instead of there existing multiple 'material-causal' interactions, i.e., between an exhaustive set of Environmental Factors and a single organism (e.g., which is assumed to determine whether that organism "survives" or "doesn't survive"); or between the organism's (deeper) 'Genetic Factors' and its 'Phenotypic Property' (e.g., which is supposed to determine whether particular phenotypic properties of that organism "exist" or "don't exist" - hence indirectly determining that organism likelihood of "surviving" or "not surviving"); or between the (still deeper) organism's 'Genetic Encoding' process and its expression of certain Protein Synthesis (e.g., which is once again assumed to determine the specific Phenotypic Property which determines the organism's "adaptability" or "compatibility" to the Environmental Factors, and hence determines whether that organism shall "survive" or be "extinct" etc.) - according to the computational Duality Principle there seems to exist only one singular conceptually higher-ordered computational level, 'D2' which is responsible for an "a-causal" computation of the existence of "co-occurring" pairs of 'organism-environment', genetic factors-phenotypic property, and genetic encoding process-protein synthesis etc...

Obviously, such conceptually higher-ordered "a-causal" D2 computation is quite "alien" to the basic Cartesian-causal conception wherein it is assumed that any naturally occurring phenomenon is necessarily caused by another material element/s (e.g., which are implicitly assumed to be caused by a series of ever more fine material-causal processes)... However, it is suggested that precisely through the above mentioned application of the Duality Principle analysis of any (single- or multiple- level) SROCS scientific paradigm it can be shown that such Cartesian-causal 'Black Box Hypothesis' is falsified and must necessarily point at the existence of a singular conceptually higher-ordered 'D2' computational framework which merely computes the "co-occurrences" of (single or multiple) computational 'x-y' pairs... Thus, in the case of Darwin's evolutionary tertiary SROCS structured computational paradigm it becomes clear that the material-causal (Cartesian) relationships must give way to a singular higher-ordered a-causal D2 computational framework which computes the "co-occurrences" of the above mentioned three pairs series, i.e., which "co-exist" rather than cause each other...

Indeed, it is suggested that precisely due to Cartesian science's (ingrained) material-causal working hypothesis, that the computational Duality Principle's conceptual proof for the principle inability to compute the "existence" or "non-existence" of any hypothetical 'di1...din' specific 'y' element - from *within* its direct or indirect physical relationship/s with any other (exhaustive) 'x-series' inevitably leads to both 'logical inconsistency' and (ensuing) 'computational indeterminacy' that are contradicted by robust empirical findings (e.g., in the case of each of the earlier mentioned SROCS scientific computational paradigms); Hence, the (generalized) Duality Principle has proven the conceptual computational fallacy of any such single- or multiple- 'Black Box Hypothesis' (BBH) based on an exhaustive analysis of any single or multiple SROCS computational level/s or factor/s - instead pointing at a singular conceptually higher-ordered D2 computational framework which can merely compute the "co-occurrences" of a series of 'x-y' pairs... Indeed, it is due to the generalized Duality Principle's conceptual proof for the principle inability of the multi-layered and (infinitely) complex BBH to determine any of its (single or multiple) SROCS $x \rightarrow y$ material-causal relationships that it is able to point at the conceptually higher-ordered singular D2 computational framework as the only viable means for determining the "co-occurrences" of any exhaustive series of 'x-y' pairs as underlying any such scientific SROCS paradigms! Finally, based on the earlier (Bentwich, 2011c) proof for the existence of only a singular such conceptually higher-ordered 'D2' Universal Computational Principle' which is responsible for computing a series of 'Universal Simultaneous Computational Frames' (USCF's) which give rise to all ('secondary') computational properties of 'space', 'time', 'energy', 'mass' (and 'causality'), it becomes clear that any such specific SROCS scientific paradigm can only be computed strictly based on this singular (higher-ordered) D2 USCF's series...

Hence, the next step is to prove in the case of each of the other scientific (key) scientific SROCS paradigms that their particular (single- or multiple-) computational (BBH) structure must necessarily be replaced by the singular D2 computational framework; Indeed, it is suggested that besides Darwin's (tertiary-leveled) SROCS evolutionary theory - there are two other (key) scientific paradigms that share the same (problematic) SROCS computational structure, and which therefore necessitate their reformalization based on the same singular conceptually higher-ordered D2 computational framework; These include: Genetics' fundamental 'genetic encoding' hypothesis and Neuroscience's basic 'psycho-physical' problem (e.g., and underlying 'materialistic-reductionistic' working hypothesis); We've already seen that perhaps two out of three of Darwin's evolutionary theory SROCS paradigms, e.g., 'Genetic Factors - Phenotype Property' and 'Genetic Encoding - Protein

Synthesis' SROCS may be constrained by the computational 'Duality Principle' (and therefore call for their replacement by a corresponding higher-ordered singular 'D2 a-causal' computational framework); Indeed, when presented in the context of Darwin's evolutionary (tertiary) SROCS structure, it was shown that these specific 'Genetic Factors - Phenotype Property' and 'Genetic Encoding - Protein Synthesis' SROCS paradigms do not alter the basic constraint imposed by the (generalized) computational Duality Principle upon all SROCS scientific paradigms (as well as does not alter the need to replace all three-leveled Darwin's evolutionary theory SROCS with the singular higher-ordered D2 a-causal computational framework)... As such, the identification of these two genetics related computational SROCS paradigms (e.g., alongside Darwin's third evolutionary SROCS paradigm of 'Natural Selection') may indeed point at the (abovementioned) need to replace Darwin's tertiary SROCS computational structure by a singular conceptually higher-ordered 'D2 a-causal' computational framework...

But, given the fact that apart from the involvement of these two 'Genetic Factors - Phenotype Property' and 'Genetic Encoding - Protein Synthesis' SROCS paradigms within Darwin's (tertiary) evolutionary theory, these two SROCS computational paradigms also stand at the basis of the central scientific field of Genetics (e.g., in particular and Biology more generally), it is important to scrutinize these two basic genetics SROCS computational paradigms in terms of their fundamental definition of Genetics (and Biology)...

Indeed, it is suggested that the entire field of Genetics (and Biology more generally) may be founded upon these two basic 'Genetic Factors - Phenotype Property' and 'Genetic Encoding - Protein Synthesis' scientific SROCS paradigms; As such, their (above sown) constraint by the computational Duality Principle may call for a rather basic transformation of the scientific fields of Genetics (and Biology) based on the Duality Principle's proof for the need to base these SROCS computational paradigms upon the singular higher-ordered D2 a-causal computational framework;

In a nutshell, it is suggested that the entire field of Genetics is anchored in- and (completely) based upon- these two basic 'Genetic Factors - Phenotype Property' and 'Genetic Encoding - Protein Synthesis' SROCS paradigms... This is because the basic tenet of modern Genetics research (and understanding) is that any genetic process or phenomenon is anchored in and entirely based upon the (direct or indirect) physical relationship/s between certain Genetic Factors and particular Phenotypic Properties which are further mediated (or fragmented into) a secondary (direct or indirect) physical relationship between specific Genetic Encoding processes and particular 'Genetic Encoding' and 'Protein Synthesis' factors... Even more generally, it is suggested that the whole domain of modern Biological research (and scientific body of knowledge) is based upon the basic working assumption that the fundamental 'building-blocks' of all biological organisms is guided by- and based upon- these dual processes of 'Genetic Factors - Phenotype Property' and 'Genetic Encoding - Protein Synthesis' SROCS paradigms; Indeed, one may say that in much the same manner that Physics serves as the most basic building block for all other scientific domains (e.g., because it tells us what are the basic 'building blocks' of nature), these two genetics SROCS paradigms inform all the rest of Genetics and Biology in terms of the fundamental processes by which all biological phenomena, processes or organism/s are produced (and operate through etc.)

Thus, it is suggested that the whole domain of Genetics is based upon the basic working hypothesis wherein any characteristic/s- function/s- organ- tissue/s- or cellular structure/s etc. of any biological organism etc. is entirely dependent upon a series of (direct or indirect)

physical interactions between an exhaustive set of Genetic Encoding factors and the production of specific Protein Synthesis, which in return are (solely) responsible for the production of an organism's particular Phenotypic Property; Hence, the production of any (possible) protein found within an organism is assumed to be solely determined through its (direct or indirect) physical interaction/s with an exhaustive set of Genetic Encoding processes, which are governed (solely and strictly) by an exhaustive set of Genetic Factors (e.g., responsible for the production of the specific Protein Synthesis processes). Therefore, we also obtain a (slightly similar) dual leveled SROCS computational structure of this form:

$$\text{PR}\{G(1\dots n), P\text{-synth}\} \rightarrow [\text{'P-synth'} \text{ or } \text{'not P-synth'}] \quad (7)$$

$$\text{PR}\{P\text{-synth}(1\dots n), \text{Phenotype}_i\} \rightarrow [\text{'Phenotype}_i \text{ ' or } \text{'not Phenotype}_i\text{'}] \quad (8)$$

Indeed, it is suggested that all genetic-originated biological processes and functions arise (e.g., in one form or another) from this dual-leveled SROCS paradigm: Thus, whether it is the genetic encoding of certain RNA proteins, mRNA activation of specific protein synthesis, the translation of any genetic (single or multiple) factor/s into three-dimensional protein structure/s or their translation into any (simple or complex) organism phenotype, trait or characteristics – all of these genetic encoding, transcription, synthesis and production/interface with any organism's phenotypic property must necessarily rely on the basic assumed (above mentioned) dual-leveled SROCS computational structure.

However, as shown (earlier) the composition of this dual-level Genetics SROCS computational structure is necessarily constrained by the (generalized) Duality Principle; This is due to the fact that each of the constituent SROCS paradigms is necessarily constrained by the Duality Principle (e.g., pointing at the existence of a conceptually higher-ordered D2 a-causal computational framework); Even beyond that the (abovementioned) fallacy of the BBH indicates that regardless of the number of intervening- or mediating- or complex- fragmentation (or makeup) of the basic Genetics SROCS computational structure of the form:

$$\text{PR}\{G(1\dots n), P\text{-phenotype}(1\dots n)\} \rightarrow [\text{'P-phenotype}(1\dots n) \text{ ' or } \text{'not P-phenotype}(1\dots n)\text{'}] / di1\dots din$$

the Duality Principle necessarily constrains any such (single or multiple) computational levels (di1...din) or any (single or multiple) mediating factor/s $P\text{-phenotype}(1\dots n)$, and points at the existence of a conceptually higher-ordered D2 a-causal computational framework;

Indeed, in much the same manner in which the (generalized) Duality Principle has shown that all of Darwin's evolutionary (tertiary) SROCS computational levels must give way to (three) levels of simultaneously "co-occurring" ('x-y') pairs, so in the case of the (above mentioned) Genetics dual-level SROCS structure it is suggested that an application of the (generalized) Duality Principle points at the existence of the (same) conceptually higher-ordered singular 'D2 a-causal' computational framework which computes (simultaneously) the "co-occurrences" of dual levels of 'Genetic Factors – Protein Synthesis' and 'Protein Synthesis – Phenotype Property' computational pairs.

In other words, it is shown that an (embedded) part of the (above mentioned) tertiary computational structure of Darwin's evolutionary theory is the generalized (dual) 'Genetic Computation' SROCS structure; Therefore, since Darwin's (broader) evolutionary theory (tertiary) SROCS was shown to be based on a (triple strict) '*material-causal*' physical relationships between an organism's 'Genetic Factors \rightarrow Protein Synthesis' ; which is assumed to also cause any specific (e.g., single- or multiple- relevant) Phenotypic Property,

thus: 'Protein Synthesis → Phenotypic Property'; which (in return) also caused the survival ("existence") or extinction ("non-existence") of any given organism: 'Phenotypic Property → Organism' ; hence, it is also shown that modern 'Genetic Computation' (dual) SROCS structure may be based on that organism's (direct or indirect) physical interaction/s between its 'Genetic Factors → Protein Synthesis' ; and 'Protein Synthesis → Phenotypic Property'.

But, we've already seen that the discovery of the Duality Principle forced relinquishing any such strict -'materialistic-reductionistic' (generalized) SROCS computational structure, in favor of a conceptually higher-ordered 'D2 a-causal' computational framework which negates the existence of any such material-causal (tertiary) physical relationship. Instead, the (generalized) Duality Principle (format) has proven that *regardless of the number of computational levels or factors* that may be associated with the production of any given organism's phenotype or of the number of (direct or indirect) physical interactions between the organism and its environment, the only viable computation that determines any relationships between a given organism and its environment or any between constituent (genetic, protein synthesis or other) elements within the organism and its phenotypic property or properties is a *singular conceptually higher-ordered D2 computational framework which can only determine the simultaneous "co-occurrences"* of any such (single, multiple or exhaustive) pairs of 'Environmental Factors - Organism' ; 'Genetic Factors - Phenotypic Property'; or 'Genetic Encoding Factors - Protein Synthesis' pairs series...

Therefore, it necessarily follows that the whole of Genetic Science (e.g., including all single-multiple- or exhaustive- factors, computational level/s, phenomena, processes etc. describing an organism's genetic, protein, biological etc. makeup, functioning, development or characteristics etc.) must be anchored in- and based upon- such singular (conceptually higher-ordered) D2 a-causal computational framework which can only compute the "co-occurrences" of any 'Genetic-Factors - Protein Synthesis'; and 'Protein Synthesis - Phenotypic Property' pairings (e.g., occurring simultaneously at any given spatial-temporal point/s)...

Hence, instead of the current 'materialistic-reductionistic' (dual) SROCS structure underlying all Genetic Science (research and theoretical body of knowledge), the (generalized) Duality Principle points at the existence of a singular (conceptually higher-ordered) 'D2 a-causal' computational framework which merely computes the "co-occurrences" of any given pairs of 'Genetic Factors - Protein Synthesis' and 'Protein Synthesis - Phenotypic Property'. This means that instead of any exhaustive pool of Genetic Factors "causing" a given organism's resulting Phenotypic Property (or properties), the application of the (generalized) Duality Principle points at the existence higher ordered (singular) D2 computation which simultaneously computes the "co-occurrences" of all of the various aspects of an organism's genetic, protein synthesis, development, traits etc. (e.g., and in the broader scope of Darwin's tertiary evolutionary theory - also of all exhaustive series of any simultaneous 'Environmental Factors') taking place at any given spatial-temporal point/s or interval.

Indeed, it is suggested that such basic shift from the materialistic-reductionistic working assumption underlying current Genetic Science formulation towards a conceptually higher-ordered D2 a-causal computation may bear a few potentially significant theoretical ramifications: First, such conceptually higher-ordered 'D2 a-causal' computational framework necessarily replaces the currently assumed material-causal relationships between any exhaustive set of Genetic Factors which are assumed to cause particular

Protein Synthesis which (in turn) cause particular Phenotypic Properties to appear in a given organism (which may be further extended to include Darwin's Natural Selection SROCS' assumed causal relationship between the above 'Phenotypic Properties' which are assumed to directly interact with an exhaustive set of 'Environmental Factors', wherein it is assumed that the direct or indirect physical relationship of these Environmental Factors with the organism's Phenotypic Properties causes the determination of the "existence" or "non-existence" of any such given organism):

Instead, based on the (above mentioned) generalized Duality Principle's proof for the conceptual computational inability of any (single or multiple) SROCS structure to determine the "existence" or "non-existence" of any (SROCS) particular 'y' from within its direct (or indirect) physical interaction with any other exhaustive X series, the Duality Principle asserts the existence of a (singular) conceptually higher-ordered 'D2 a-causal' computational framework that computes (simultaneously) the "co-occurrences" of any (single or multiple levels) SROCS' 'x' and 'y' pairs series; Thus, the generalized Duality Principle points at the operation of a singular conceptually higher-ordered 'D2 a-causal' computational framework which computes (simultaneously) the "co-occurrences" of all of the abovementioned (dual or tertiary SROCS) computational pairs, thus:

D2 A-Causal Computation:

$$D2: \{[E_{\{1...n\}}, o]st_1; \{E_{\{1...n\}}, o\}st_2 \dots \{[E_{\{1...n\}}, o]st_n\}.$$

$$D2: \{[G_{\{1...n\}}, 'phi(o)']st_1; \{G_{\{1...n\}}, 'phj(o)']sti; \dots [G_{\{1...n\}}, 'phn(o)']stn\}.$$

$$D2: \{[Ge_{\{1...n\}}, pi-synth(o-phi)]st_1; Ge_{\{1...n\}}, pj-synth(o-phi)]sti\dots ; \\ Ge_{\{1...n\}}, pn-synth(o-phi)]stn\}$$

Hence, the first (potentially significant) theoretical implication of the generalized Duality Principle (e.g., in the case of the currently existing Genetic Science dual SROCS computational paradigm) is that there cannot exist any real 'material-causal' relationships between any of the dual Genetic SROCS (or tertiary Darwin's evolutionary theory SROCS) particular 'x' and 'y' factors; In other words, based on the generalized Duality Principle conceptual computational proof it is asserted that neither the Genetic Factors can "cause" any real 'Protein Synthesis', not can such (particular) Protein Synthesis "cause" any real 'Phenotypic Property' in an organism; nor can any such 'Phenotypic Property' have any real physical interaction with an exhaustive set of 'Environmental Factors' – thereby "causing" the "existence" (survival) or "non-existence" (extinction) of any given (single or multiple) organism/s... Instead, the generalized Duality Principle asserts that there exist a singular conceptually higher-ordered D2 a-causal computational framework which computes *simultaneously* the "co-occurrences" of all of these 'Genetic Factors *st(i)*', 'Protein Synthesis *st(i)*', 'Phenotypic Property *st(i)*', or 'Environmental Factors *st(i)*'!

This means that as in the previous application of the computational Duality Principle in the case of the quantum and relativistic SROCS paradigms (Bentwich, 2011c) where it was shown that all of the physical properties of 'space', 'time', 'energy' and 'mass' cannot be computed based on any (quantum or relativistic) SROCS paradigms – but may only arise as secondary emerging (integrated) computational products of the singular conceptually higher-ordered 'D2 a-causal' series of 'Universal Simultaneous Computational Frames' (USCF's) computation; So also in the case of the Genetic model's dual level SROCS (or tertiary Darwin's evolutionary

theory SROCS paradigm) we reach the inevitable conclusion that all of the above mentioned constituent biological elements of 'Genetic Factors $st(i)$ ', 'Protein Synthesis $st(i)$ ', 'Phenotypic Property $st(i)$ ', or 'Environmental Factors $st(i)$ ' can only exist as secondary emerging computational properties of a singular conceptually higher-ordered 'D2 a-causal' computational framework (e.g., which are therefore computed simultaneously as "co-occurring" at the D2 singular computational level). But, since it was earlier shown above (and also in Bentwich, 2011c) that there can only exist *one* such *singular* conceptually higher-ordered D2 computational framework - which has already been shown to consist of the CUFT's USCF's series that are computed by a Universal Computational Principle, thus:

$$\frac{c^2 x'}{h} = \frac{s \times e}{t \times m}$$

then it follows that the 'D2 a-causal' computation of the abovementioned multiple pairs series of 'Genetic Factors $st(i)$ ' - 'Protein Synthesis $st(i)$ '; 'Protein Synthesis $st(i)$ ' - 'Phenotypic Property $st(i)$ '; 'Phenotypic Property $st(i)$ ' - 'Environmental Factors $st(i)$ ' may only be carried out through the singular D2 a-causal computation of the series of USCF's! What's essential to understand is that given the Duality Principle's above mentioned conceptual computational proof for the principle inability of either of the Genetic (dual) SROCS paradigms (or Darwin's Natural Selection paradigm) to determine any 'material-causal' relationship/s between any of the (abovementioned) 'Genetic Factors $st(i)$ ' \rightarrow 'Protein Synthesis $st(i)$ '; 'Protein Synthesis $st(i)$ ' \rightarrow 'Phenotypic Property $st(i)$ '; 'Phenotypic Property $st(i)$ ' \rightarrow 'Environmental Factors $st(i)$ '; but instead, the recognition that all of these 'x-y' pairs (series) are computed simultaneously as part of the same USCF's (e.g., at the conceptually higher-ordered singular D2 computational level)... Moreover, if (indeed) there cannot exist any real 'material-causal' physical relationship between any of these $x \rightarrow y$ (hypothesized particular SROCS) pairs, but only a conceptually higher-ordered (singular) D2 'a-causal' "co-occurrences" of all of these x-y pairs (series) as being computed simultaneously as part of the same (particular) USCF (frames), then it follows that the only computation responsible for such conceptually higher-ordered (singular) USCF's series (e.g., including all of its embedded particular 'x-y' pairs series) is the Universal Computational Principle which was hypothesized to be responsible for all USCF's series computation (i.e., including all of the "secondary computational integrated" physical properties of 'space', 'time', 'energy' and 'mass' etc.)

Note that despite the apparent "radical" theoretical conclusion that seems to stem from an application of the (generalized) Duality Principle in the case of the above (dual) Genetic Science SROCS computational structure (and its extended Darwin's Natural Selection assumed SROCS computational paradigm)- i.e., that there cannot exist any (real) "causal-material" physical relationship between any (exhaustive hypothetical) series of 'Genetic Factors $st(i)$ ' \rightarrow 'Protein Synthesis $st(i)$ '; 'Protein Synthesis $st(i)$ ' \rightarrow 'Phenotypic Property $st(i)$ '; 'Phenotypic Property $st(i)$ ' \rightarrow 'Environmental Factors $st(i)$ ', but rather that there exists only one (singular) conceptually higher-ordered 'D2' a-causal' computational framework that computes simultaneously the series of USCF's (various) 'x-y' pairs, such conceptually higher-ordered D2/USCF's computational level is proven based precisely upon such a rigorous computational and empirical analysis (e.g., pertaining to any SROCS computational structure which inevitably proves the computational constraint imposed by the 'Duality Principle'). Furthermore, the adoption of such a conceptually higher-ordered

'D2 a-causal' computational mechanism – e.g., anchored in the USCF's series (computed by the singular 'Universal Computational Principle'), instead of the currently assumed 'materialistic-reductionistic' SROCS computational structure does not negate any of the (already known) empirical facts or body of knowledge pertaining to any biological intra-organism (genetic, protein synthesis, phenotypic etc.) or inter-organism (environmental or other evolutionary) empirical findings; Rather, the theoretical explanation (or construct) upon which these empirically well-validated facts are based is shifted (or even expanded) from the narrow constraints of any (hypothetical exhaustive) 'material-causal' (direct or indirect) physical relationship/s between any particular 'x→y' pair/s to a 'D2 a-causal' relationship/s between all potential 'x and 'y pairs (series) that are embedded within the exhaustive Universal Simultaneous Computational Frames (USCF's) series that are being computed by a singular Universal Computational Principle...

Finally, it should be noted that as shown previously (Bentwich, 2011b), the Computational Unified Field Theory's (CUFT) analysis of the production of the series of Universal Simultaneous Computational Frames (USCF's) is carried out by a *Universal Computational Principle* – which is the only computational (e.g., rather than "material" or "physical") element that exists "in-between" any two USCF's frames; This stemmed from the fact that it was shown that there can only exist one (singular) conceptually higher-ordered D2 computational level – which is (in principle) irreducible to any exhaustive-hypothetical 'x→y' (direct or indirect) physical relationship/s; Based on this conceptual computational constraint imposed by the 'Duality Principle' (e.g., negating the existence of any real 'x→y' physical relationship, but rather its replacement by a conceptually higher-ordered D2 computation of the "co-occurrences" of simultaneously occurring 'x-y' pairs embedded within the same USCF's) and empirical-computational postulate of the existence of these disparate USCF's (e.g., which coalesces well-validated quantum and relativistic empirical phenomena such as Planck's minimal inter-USCF's 'h' constant as well as the hypothetical extremely rapid rate of USCF's computation given by $c^2/'h'$) it was hypothesized that there cannot exist any material element "in-between" two such postulated USCF's – except for the 'Universal Computational Principle' which computes each of these series of USCF's... Indeed, the hypothesized Universal Computational Formula:

$$\frac{c^2x'}{h} = \frac{s x e}{t x m}$$

precisely outlines the fact that all computational features of 'space', 'time', 'energy', 'mass' (and 'causality') arise as secondary (integrated) physical properties of the conceptually higher-ordered D2 Universal Computational Principle's production of these series of USCF's frames). Therefore, when viewed from the conceptually higher-ordered perspective of the 'D2 a-causal' computational framework, all hypothetical (exhaustive) series of 'x-y' pairs may only be computed by the (singular) Universal Computational Principle as embedded within the series of USCF's (e.g., thereby replacing any of the currently assumed 'materialistic-reductionistic' direct or indirect "causal" relationship/s between any hypothetical exhaustive 'x→y' pair/s).

Indeed, perhaps a good mode of explaining the potential transformation from the contemporary purely 'materialistic-reductionistic' SROCS computational structure (e.g., underlying key scientific SROCS paradigms described in this article) to the conceptually higher-ordered 'D2 a-causal' computational framework – is to analyze the (metaphorically

'equivalent') case of the cinematic film sequence underlying any apparently "material-causal" relationships that may exist between any two 'x' and 'y' elements (e.g., within a given cinematic film); As hinted in a previous article (Bentwich, 2011c) it is suggested that underlying any such apparent " $x \rightarrow y$ " physical relationship (within any given cinematic film sequence), there cannot be any "real" 'material-causal' relationship within the film sequence; This is because it is shown based on the cinematic film metaphor that in order for any 'physical relationship' to exist through any (hypothetical) sequence of cinematic film frames, there must exist a certain pattern of "co-occurrences" of the given 'x' and 'y' elements – i.e., such as for instance that the 'x' factor appears to be located "spatial-temporally" closer and closer to the 'y' element (across a certain number of cinematic frames) which then leads to an alteration in the 'y' factor's (particular) condition (or spatial-temporal configuration etc.); In other words, for the appearance of any (hypothetical) "physical causality" to exist between the 'x' and 'y' factors within any film sequence there must be a (certain) series of film frames across which the "spatial-temporal" relationship between the 'x' and 'y' factors is transformed... To put it succinctly, it is suggested that it is not possible (e.g., in principle) to have any "causal-material" relationship between any two (hypothetical) 'x' and 'y' elements – that is not based on an alteration in the spatial-temporal (proximity and configuration) of any two such 'x' and 'y' elements across a number of cinematic film frames. But, once we realize that it is not possible to obtain any "material-causal" relationship between any two (hypothetical) 'x' and 'y' elements – which is not based on a change in the their "co-occurring" pattern *across a few cinematic film frames* the door is open to evince that there cannot in fact exist any "real material" element that can "pass" in-between any two such (hypothetical) cinematic film frames!? But since we know that there does not exist any "material" element that exists "in-between" any two such hypothetical cinematic film frames (e.g., ' $f-i$ ' and ' $f-i+n$ '), then we must conclude that the only viable means for producing any such apparent "material-causal" relationship/s is based on the alteration in the spatial-temporal configuration of the 'x' and 'y' elements (across a series of cinematic frames)... In other words, since there is not "material" element that can pass "in-between" two such hypothetical cinematic film frames (e.g., ' $f-i$ ' and ' $f-i+n$ ') and since the existence of any hypothetical material-causal" physical relationship between any two hypothetical 'x' and 'y' elements is contingent upon a certain pattern of change in the 'x-y' spatial-temporal configuration across such (hypothetical) cinematic film sequence then it follows that the only means for producing any "causal" relationship between the 'x' and 'y' elements is only based on their "co-occurring" spatial-temporal across a certain number of cinematic frames... Finally, precisely based on this keen (computational) analysis wherein it is shown that any hypothetical "causal-material" $x \rightarrow y$ relationship can only evolve based on their particular spatial-temporal configuration (across a series of cinematic film frames), and since there cannot be any "material" element that can pass "in between" any two subsequent cinematic film frames, then we are also led to conclude that the only means for arranging the particular "co-occurrence" of any apparently spatial-temporal "causal" pattern of change in the 'x' and 'y' configuration across a series of cinematic frames is based on a conceptually higher-ordered computation (or arrangement) of the 'x' and 'y' "spatial-temporal" sequencing across these series of frames... Ultimately, since there is no "material" element that can pass "in-between" any two subsequent (hypothetical) film frames and since the perception of any apparent "causal-material" physical relationship between the 'x' and 'y' elements is contingent upon a particular pattern of change in the "spatial-temporal" configuration of the 'x' and 'y' elements across a series of cinematic film frames – then this

points at the existence of a conceptually higher-ordered "non-material" computational element that is responsible for this particular spatial-temporal pattern of change across the film frames...

Indeed, it is hypothesized that the above metaphor of the cinematic film sequence may be entirely analogous to the Computational Unified Field Theory's (CUFT) (Bentwich, 2011c) account - not only in terms of the secondary (integrated) emerging physical features of "space", "time", "energy", "mass", but may also pertain to the basic (implicit) concept of "causality"; Previously, the cinematic film metaphor has been used as a 'pointer' to some of the hypothetical features of the CUFT including its delineation of the emerging (secondary) computational properties of 'space', 'time', 'energy' and 'mass' (e.g., wherein it was shown that the apparently physical properties of 'space' and 'energy', 'mass' and 'time' may arise as secondary computational combinations of a 'consistent' vs. 'inconsistent' computations of whole 'frame' presentations of the same object or event or of only partial segments of the whole frame entitled: 'object' - 'consistent' or 'inconsistent' presentations). The abovementioned postulated Computational Unified Field Theory's account of the four basic physical features (of 'space', 'time', 'energy' and 'mass') was also based on the existence of a hypothetical conceptually higher-ordered (D2) 'Universal Computational Principle' ("U") which may carry out extremely rapid (c^2/h) computational process giving rise to a series of 'Universal Simultaneous Computational Frames' (USCF's). The essential point to be noted is that based on the earlier outlined Duality Principle which proved that there can only exist one singular conceptually higher-ordered 'D2' computational framework that can (solely) determine all exhaustive hypothetical (quantum, relativistic or any other) 'x-y' "co-occurrences" across the series of (hypothesized) USCF's the CUFT was capable of replicating all known quantum and relativistic phenomena (as well as potentially harmonize all existing apparent contradictions between these two major pillars of modern Physics). But, if indeed the entire corpus of (all possible hypothetical) quantum and relativistic features, phenomena, laws and theoretical explanations can only be derived from such a Duality Principle based conceptually higher-ordered D2 (e.g., 'Universal Computational Principle' 'U') computation of a series of (extremely rapid) USCF's (Bentwich, 2011c), then it also necessarily follows that the CUFT's account of any (apparently) "material-causality" must also be transformed; Indeed, somewhat alike the cinematic film metaphor's demonstration that there cannot exist any real "material-causal" relationship between any hypothetical 'x' and 'y' factors - but only a conceptually higher-ordered ('D2') arrangement of the "co-occurrences" of a specific spatial-temporal configuration of the 'x' and 'y' factors (as discussed above), it is suggested that the CUFT's portrayal of a series of extremely rapid USCF's does not allow for any "material" element/s to pass "in-between" any two (hypothetical) USCF's except for the conceptually higher-ordered (immaterial) 'Universal Computational Principle' ("U") which alone can compute the particular "co-occurrences" of a series of 'x-y' pairs that can give rise to the apparent existence of a "causal" relationship between the 'x' and 'y' elements...

Hence, we arrive at the inevitable conclusion wherein any apparent "material-causal" relationship/s between any hypothetical 'x' and 'y' factors (e.g., embedded within one of the key SROCS scientific paradigms) - must necessarily arise as secondary emerging computational property associated with a particular 'spatial-temporal' "co-occurrences" of the particular 'x' and 'y' factors' configuration across a series of USCF's... To follow the cinematic film metaphor, there does not exist any "real material-causality" between any two hypothetical 'x' and 'y' elements, but only the "co-occurrence" of the particular 'x' and 'y'

factors across a series of USCF's (e.g., as computed by a conceptually higher ordered D2 computational principle – which in the case of the CUFT is the 'Universal Computational Principle'). Therefore, it may be said that perhaps underlying all scientific SROCS paradigms there cannot exist any (real) "material-causal" relationship/s between any two hypothetical 'x' and 'y' elements, but only the computation of their "co-occurrences" (e.g., in a particular spatial-temporal sequence as explained above) across a series of USCF's (as computed by the conceptually higher-ordered D2 'Universal Computational Principle' ("))...

This means that in the two (abovementioned) cases of Darwin's (tertiary) evolutionary theory SROCS computational structure as well as in the case of the (dual) Genetic Science SROCS computational structure an application of the (generalized) Duality Principle and its broader development within the CUFT has pointed at the existence of a series of USCF's that are computed by the conceptually higher-ordered ('D2') 'Universal Computational Principle' (") and which give rise to any SROCS apparent "material-causal" ($x \rightarrow y$) relationships that are underlie by a particular series of "co-occurring" x-y pairs in which the 'spatial-temporal' relationships (e.g., as embedded within a series of corresponding USCF's, as explained above).

This means that both in the case of Darwin's (tertiary) SROCS computational structure as well as in the case of Genetic Science (dual) SROCS computational structure we must replace the currently assumed direct (or indirect) 'material-causal' relationship between any two particular 'x' and 'y' elements by the conceptually higher-ordered D2 computation of the "co-occurrences" of the corresponding (triple or dual) SROCS series of 'x-y' pairs that give rise to the appearance of any "material-causal" relationship; As discussed above, in both cases there exists a (hypothetical) conceptually higher-ordered D2 computational level which carries out the simultaneous computation of the "co-occurrences" of Darwin's SROCS paradigm's alternate 'Environmental Factors $st(i)$ ' and 'Phenotypic Property $st(i)$ ' pairs series, as well the two other (Genetic SROCS dual pairs of) 'Genetic Factors $st(i)$ ' and 'Protein Synthesis $st(i)$ ', and the 'Protein Synthesis $st(i)$ ' and 'Phenotypic Property $st(i)$ ' series. Indeed, according to the CUFT's (broadened application of the Duality Principle) such conceptually higher-ordered D2 simultaneous computation of each of these evolutionary and genetic encoding computational pairs constitutes the (extremely rapid hypothetical) series of USCF's that are carried out by the singular 'Universal Computational Principle' ("). Thus, instead of the existence of any 'real' "material-causal" relationship/s between any of these (evolutionary or genetic) SROCS' particular 'x' and 'y' factors – all that truly exists is the conceptually higher-ordered (singular) Universal Computational Principle's (") simultaneous computation of a series of (extremely rapid) USCF's in which there is an embedded series of 'Environmental Factors $st(i)$ ' and 'Phenotypic Property $st(i)$ '; 'Genetic Factors $st(i)$ ' and 'Protein Synthesis $st(i)$ '; and the 'Protein Synthesis $st(i)$ ' and 'Phenotypic Property $st(i)$ ' pairs series (which give rise to the appearance of 'real' interactions within seemingly "material-causal" SROCS ' $x \rightarrow y$ ' relationships)...

Finally, it is suggested that the application of the Duality Principle's asserted conceptually higher-ordered 'D2' (Universal Computational Principle's) computation of the series of USCF's which also embed all (exhaustive-hypothetical) 'x-y' pairs e.g., as replacing all scientific SROCS paradigms' apparent ($x \rightarrow y$) "material-causal" relationships should be implemented; Hence, the next step in the application of the computational Duality Principle to various other scientific SROCS paradigms consists of a (triple) demonstration that each of these (remainder) scientific SROCS paradigms is constrained by the (generalized) Duality Principle, may contain

the (abovementioned) 'Black-Box-Hypothesis' (BBH) (e.g., which we've already seen cannot alter the basic computational constraint imposed by the generalized Duality Principle format), and therefore inevitably calls for the CUFT's assertion regarding the need to replace the currently assumed SROCS (particular) "material-causal" ('x→y') relationship with a conceptually higher ordered (Universal Computational Principle's ') computed series of "co-occurring" 'x-y' pairs (as embedded within a rapid series of USCF's being computed by this hypothetical Universal Computational Principle).

3.2 The Duality Principle: Constraint of the 'Psycho-Physical Problem' (PPP) SROCS

It is hypothesized that another key scientific SROCS paradigm consists of Neuroscience's Psycho-Physical Problem (PPP); This is because the PPP which is defined as the question regarding how it may be possible for any given physical stimulus (or stimuli) to be translated into a neurochemical signal within the Central Nervous System (in humans) – is currently assumed to be resolved through Neuroscience's basic 'materialistic-reductionistic' (generalized) 'Psycho-Physical SROCS' computational structure: Essentially, Neuroscience's basic (generalized) 'Psycho-Physical SROCS' assumes that the determination of the "existence" or "non-existence" of any hypothetical (exhaustive) Psycho-Physical Stimulus or stimuli (e.g., 'PPs-i' - including all physical stimulation or any of its derived or associated physical features, properties, representations etc.) is determined solely based on its direct or indirect physical interactions with an exhaustive set of 'Neural Activation/s' (e.g., 'N_{a(1...n)}' – an exhaustive hypothetical series of neurons, neural connections, neural activation/s neurophysiological activity or pattern/s etc. which may take place at different single or multiple spatial-temporal points in the human Nervous System);

$$\text{SROCS: PR}\{ \text{PPs-}i, \text{N}_{a(1\dots n)} \} \rightarrow [\text{'PPs-}i \text{' or 'not PPs-}i \text{' }] / \text{di1...din}$$

Thus, for instance, it is currently assumed that the computation of the "existence" or "non-existence" of any such Psychophysical Psycho-Physical Stimulus, e.g., human consciousness or awareness to the existence of any given physical stimulus intensity (termed: termed: PPs-pp) – is strictly caused by the direct (or indirect) physical interaction of such 'Consciousness Psychophysical Stimulus' (C_{s-pp}) with an exhaustive hypothetical series of 'Neural Activation/s' (e.g., including any exhaustive hypothetical activity or activation of any neuron/s, neural activation, neuronal pattern/s etc. in the human brain):

$$\text{SROCS: PR}\{ \text{N}_{(1\dots n)}, \text{C}_{s-pp} \} \rightarrow [\text{'C}_{s-pp} \text{' or 'not C}_{s-pp} \text{' }] / \text{di1...din}$$

But, such SROCS computational structure was previously shown (Bentwich, 2006a) to produce an inevitable SRONCS (e.g., 'Self-Referential Ontological Negative Computational System', as described earlier) in the case of *sub-threshold psychophysical stimulation*: SROCS: PR{ N_(1...n), C_{s-i}} → 'not C_{s-i}' / di1...din

Indeed, such SRONCS was shown to produce both 'logical inconsistency' and ensuing 'computational indeterminacy' that are contradicted by robust empirical findings indicating the *capacity* of such psychophysical computational systems to determine the "existence" or "non-existence" of any given psychophysical stimulation (e.g., including in the case of sub-threshold psychophysical stimulus); therefore, the Duality Principle pointed at the existence of a conceptually higher-ordered 'D2 a-causal' computational framework which is capable of computing the existence of any series of pairs of any given Consciousness-Stimuli and an exhaustive hypothetical series of all possible 'Neural Activation' hypothetical), thus:

$$D2: \{[N_{(1...n) \text{ st-}i} C_{s\text{-pp st-}i}] ; \dots ; [N_{(1...n) \text{ st-}i+n} C_{s\text{-pp st-}i+n}]\}$$

As proven previously (and represented in the generalized SROCS computational structure encompassing any single or multiple computational elements, factors etc., di1...din), the computational constraint imposed on the above Psychophysical SROCS structure is *conceptual* in nature - i.e., it holds true regardless of the number of neurons, neuronal interactions or spatial temporal point/s at which any direct or indirect physical interaction may take place between the given Consciousness Psychophysical Stimulus and any exhaustive hypothetical series of Neural Activations; This is because the formalization of this (primary) Psychophysical-Consciousness Stimulation SROCS already encompasses all direct or indirect physical interactions between any given Psychophysical Stimulation and an exhaustive set of all possible Neural Activations (occurring at any potential spatial-temporal point/s or interval/s etc.), and indicates that as such it inevitably leads to both 'logical inconsistency' and subsequent 'computational indeterminacy' (e.g., in the case of sub-threshold Psychophysical Stimulation SRONCS system) that are contradicted by well validated empirical findings...

Next, it is hereby hypothesized that the abovementioned Psychophysical Consciousness Stimulation SROCS may serve as a primary SROCS level within a multi-layered PPP SROCS computational structure, which may be generally divided into (at least) four separate SROCS computational levels including:

1. **Psycho-Physical Consciousness SROCS:** $PR\{C_{s\text{-pp}} , Na(s\text{-pp})\} \rightarrow ['C_{s\text{-pp}} ' \text{ or } 'not C_{s\text{-pp}} '] / di1...din$
2. **Functional Consciousness SROCS:** $PR\{C_{s(pp)\text{-}fi} , Na(spp\text{-}fi)\} \rightarrow ['C_{s(pp)\text{-}fi} ' \text{ or } 'not C_{s(pp)\text{-}fi} ']$.
3. **Phenomenological Consciousness SROCS:** $PR\{C_{s(pp)\text{-}fi}\text{-}Ph , Na(spp\text{-}fi)\text{-}Ph)\} \rightarrow ['C_{s(pp)\text{-}fi}\text{-}Ph ' \text{ or } 'not C_{s(pp)\text{-}fi}\text{-}Ph '] / di1...din$
4. **Self-Consciousness SROCS:** $PR\{ C_{s(pp)\text{-}fi}\text{-}Ph\text{-}S , Na(pp\text{-}fi)\text{-}Ph\text{-}S\} \rightarrow ['C_{s(pp)\text{-}fi}\text{-}Ph\text{-}S ' \text{ or } 'not C_{s(pp)\text{-}fi}\text{-}Ph\text{-}S ']$.

Below is a delineation of the various hierarchical-dualistic computational levels currently assumed by Neuroscience's materialistic-reductionistic working hypothesis;

1. **Psycho-Physical Consciousness SROCS:** $PR\{C_{s(pp)\text{-}fi} , Na(spp\text{-}fi)\} \rightarrow ['C_{s(pp)\text{-}fi} ' \text{ or } 'not C_{s(pp)\text{-}fi} ']$: wherein it is currently assumed that the (primary) Psychophysical Stimulation Consciousness SROCS' resulting output (e.g., $['C_{s\text{-pp}} ' \text{ or } 'not C_{s\text{-pp}} '] / di1...din$) undergoes a secondary SROCS computational structure in which the "existence" or "non-existence" of the (primary SROCS) 'Psychophysical Stimulation Consciousness' is analyzed in terms of the "existence" or "non-existence" of any particular 'Psychophysical Stimulation Functional Consciousness' (i.e., such as any given physical property, attribute, phenomenon etc., represented by: $'C_{s(pp)\text{-}fi} '$); It is hypothesized that this secondary 'Functional Consciousness' SROCS computational structure is comprised of: any direct or indirect physical interaction between a (given) Psychophysical Stimulation Functional Consciousness input (e.g., $'C_{s(pp)\text{-}fi} ' \text{ or } 'not C_{s(pp)\text{-}fi} '$ which is equivalent to the above primary SROCS's: $'C_{s\text{-pp}} ' \text{ or } 'not C_{s\text{-pp}} '$ output), and another exhaustive set of Neural Activation/s responsible for computing "existence" or "non-existence" of that particular given Psychophysical Stimulation Consciousness Function; However, as shown earlier, this secondary SROCS paradigm also shares the same SROCS computational structure and as such is constrained by the same (generalized) Duality Principle;

2. **Functional Consciousness SROCS:** $PR\{Cs(pp)-fi, Na(spp-fi)\} \rightarrow ['Cs(pp)-fi' \text{ or } 'not\ Cs(pp)-fi'] / di1\dots din.$

This is because this (secondary) Functional Consciousness SROCS computational structure also inevitably leads to both 'logical inconsistency' and ensuing 'computational indeterminacy' in the case of a SRONCS:

$PR\{Cs(pp)-fi, Na(spp-fi)\} \rightarrow 'not\ Cs(pp)-fi' / di1\dots din.$ Once again, the generalized Duality Principle asserts that this last 'computational indeterminacy' is contradicted by validated empirical findings indicating the capacity of the human Central Nervous System (CNS) to determine any given particular functional properties of any given Psychophysical Stimulation. Therefore, the generalized Duality Principle points at the necessary existence of a conceptually higher-ordered 'D2' computational framework which computes simultaneously any series of "co-occurring" pairs of Functional Consciousness (attributes of a given psychophysical stimulus) alongside its Neural Activation correlate (e.g., at any given spatial-temporal point).

$$D2: \{[Cs(pp)fi_r, Na(spp)fi]_{st-i} ; \dots ; [Cs(pp)fi_{(i+n)}, Na(spp)fi_{(i+n)}]_{st(i+n)}\} / di1\dots din$$

Likewise, it is suggested that a further (subsequent third) potential SROCS computational paradigm level is that of 'Phenomenological Consciousness SROCS':

3. **Phenomenological Consciousness SROCS:** $PR\{Cs(pp-fi)-Ph, Na(spp-fi)-Ph\} \rightarrow ['Cs(pp-fi)-Ph' \text{ or } 'not\ Cs(pp-fi)-Ph'] / di1\dots din$ wherein the previous (secondary Functional Consciousness) SROCS output of 'Cs(pp)-fi' or 'not Cs(pp)-fi' serves as the basis for the input to the third level Phenomenological Consciousness SROCS in the form of the phenomenological experience of any such particular Consciousness Function (i.e., $Cs(pp-fi)-Ph$) which directly interacts with an exhaustive set of Neural Activations which are assumed to be responsible for carrying out this processing; Hence, this third Phenomenological Consciousness SROCS assumes that the determination of the "existence" or "non-existence" of any particular 'phenomenological experience of any particular psychophysical stimulation function' ($Cs(pp-fi)-Ph$) is solely based on direct or indirect physical interactions between such given 'phenomenological experience of any particular psychophysical stimulation function' ($Cs(pp-fi)-Ph$) and an exhaustive set of Neural Activation/s (e.g., $Na(spp-fi)-Ph$) that are assumed to be responsible for carrying out such processing...

However, as in the two preceding SROCS computational structures it is clear that such (third-level Phenomenological Consciousness) SROCS must also be constrained by the generalized Duality Principle and therefore also inevitably leads to both 'logical inconsistency' and 'computational indeterminacy' in the case of the SRONCS:

$$PR\{Cs(pp-fi)-Ph, Na(spp-fi)-Ph\} \rightarrow 'not\ Cs(pp-fi)-Ph' / di1\dots din$$

wherein the specific phenomenological experience is asserted to both "exist" and "not exist" at the same (single or multiple) computational level/s ($di1\dots din$); But, since there exists ample empirical evidence indicating the capacity of human beings to determine (for each stimulus or stimuli) whether or not a certain phenomenological feature of function "exists" or "doesn't exist", then we must accept the (generalized) Duality Principle's assertion regarding the existence of a conceptually higher-ordered 'D2' computational level; Such conceptually higher-ordered 'D2' computational framework can compute the "co-occurrences" of any hypothetical series of such particular

'phenomenological experience of any particular psychophysical stimulation function' ($Cs(pp-fi)-Ph$) and a corresponding exhaustive set of Neural Activations ($Na(spp-fi)-Ph$):

$$D2: \{[Cs(pp-fi)-Ph_i, Na(spp-fi)-Ph_i]_{st-i}; \dots [Cs(pp-fi)-Ph_{(i+n)}, Na(spp-fi)-Ph_{(i+n)}]_{st-(i+n)}\}$$

4. **Self-Consciousness SROCS:** $PR\{Cs(pp-fi)Ph-S, Na(pp-fi)Ph-S\} \rightarrow ['Cs(pp-fi)Ph-S' \text{ or } 'not\ Cs(pp-fi)Ph-S'] / di1\dots din.$

It is finally hypothesized that there exists one further (fourth and final) SROCS computational level of 'Self-Consciousness' which combines between all (third-level) Phenomenological Consciousness SROCS outputs of the "existence" or "non-existence" of any given phenomenological experience (e.g., of a particular psychophysical stimulus function) as the basis for its integrated input stimulus of a 'Phenomenological Self Stimuli' - which is assumed to directly (or indirectly) physically interact with an exhaustive hypothetical set of Neural Activation/s (e.g., comprised of all potential neuron/s, neural connection, neural activation/s etc. responsible to determine whether there "exists" or "doesn't exist" any such 'Phenomenal Self Stimuli' at any given computational level, 'di1...din').

However, as in all previous computational level SROCS since this (final) 'Self-Consciousness SROCS' is necessarily constrained by the (generalized) Duality Principle, then it also must be replaced by the conceptually higher-ordered 'D2' computational framework which computes the "co-occurrences" of any series of pairs of 'Phenomenal Self Stimuli' (e.g., comprised of the sum total of all phenomenal functional psychophysical stimuli - at any given spatial-temporal point/s) and any simultaneously occurring (exhaustive hypothetical) Neural Activation/s, thus:

$$D2: \{[Cs(pp-fi)Ph-S_i, Na(pp-fi)Ph-S_i]_{st-i}; \dots [Cs(pp-fi)Ph-S_{(i+n)}, Na(pp-fi)Ph-S_{(i+n)}]_{st-(i+n)}\}$$

Therefore, it seems that the Psychophysical Problem of human Consciousness (PPP) is currently formalized as a (four-layered) computational SROCS structure which can be represented in the general format:

$$SROCS: PR\{Cs-i, Na(1\dots n), \} \rightarrow ['Cs-i' \text{ or } 'not\ Cs-i'] / di1\dots din$$

wherein it is assumed that an hypothetical series of direct or indirect physical interactions between any possible ("external") psychophysical or ("internal") 'functional', 'phenomenological' or 'self' stimuli and an exhaustive set of Neural Activations (e.g., as described above comprised of any single or multiple spatial-temporal neural activations, patterns, interactions, neurons or neural connections or neural networks etc.) is solely responsible for determining whether any such Psychophysical, Functional, Phenomenological or Self stimulus "exists" or "doesn't exist". But, it was shown (above and previously) that the generalized 'Duality Principle' constrains any such SROCS computational structure - by proving that any SROCS structure inevitably leads to both 'logical inconsistency' and 'computational indeterminacy' which are contradicted by known empirical findings indicating the capacity of the human Nervous System to determine whether or not any given 'psychophysical', 'functional', 'phenomenological' or 'self' stimuli "exists" or "doesn't exist"; Therefore, the generalized Duality Principle proves that there must exist a conceptually higher-ordered 'D2' computational framework which can compute the "co-occurrences" of any hypothetical series of corresponding pairs of:

D2:

1. Psychophysical: $\{[N(1...n)_{st-i}, Cs_{pp\ st-i}]; \dots [N(1...n)_{st-i+n}, Cs_{pp\ st-i+n}]\}$
2. Functional: $\{[Cs(pp)_{fi}, Na(spp)_{fi}]_{st-i}; \dots [Cs(pp)_{fi(i+n)}, Na(spp)_{fi(i+n)}]_{st(i+n)}\}$
3. Phen.: $\{[Cs(pp-fi)_{Ph_i}, Na(spp-fi)_{Ph_i}]_{st-i}; \dots [Cs(pp-fi)_{Ph_{(i+n)}}, Na(spp-fi)_{Ph_{(i+n)}}]_{st-(i+n)}\}$
4. Self: $\{[Cs(pp-fi)_{Ph-Si}, Na(pp-fi)_{Ph-Si}]_{st-i}; \dots [Cs(pp-fi)_{Ph-S(i+n)}, Na(pp-fi)_{Ph-S(i+n)}]_{st-(i+n)}\}$

This means that instead of the currently assumed 'materialistic-reductionistic' SROCS paradigms – e.g., at the psychophysical- functional- phenomenological- and self- stimulus levels, the Duality Principle proves that there can only exist one (singular) conceptually higher-ordered 'D2' computational framework which computes the "co-occurrences" of each of the above (particular four level) PR $\{Cs_{-i}, Na_{(1...n)}\}$ pairs... Moreover, instead of the currently assumed 'material-causal' physical relationships between the specific $\{Cs_{-i}, Na_{(1...n)}\}$ pairs, and moreover between each of these four SROCS computational levels:

5. *Psychophysical*: $\{[N(1...n)_{st-i}, Cs_{pp\ st-i}]; \dots [N(1...n)_{st-i+n}, Cs_{pp\ st-i+n}]\}$
6. *Functional*: $\{[Cs(pp)_{fi}, Na(spp)_{fi}]_{st-i}; \dots [Cs(pp)_{fi(i+n)}, Na(spp)_{fi(i+n)}]_{st(i+n)}\}$
7. *Phen.*: $\{[Cs(pp-fi)_{Ph_i}, Na(spp-fi)_{Ph_i}]_{st-i}; \dots [Cs(pp-fi)_{Ph_{(i+n)}}, Na(spp-fi)_{Ph_{(i+n)}}]_{st-(i+n)}\}$
8. *Self*: $\{[Cs(pp-fi)_{Ph-Si}, Na(pp-fi)_{Ph-Si}]_{st-i}; \dots [Cs(pp-fi)_{Ph-S(i+n)}, Na(pp-fi)_{Ph-S(i+n)}]_{st-(i+n)}\}$

The Duality Principle conceptually proves that there cannot (e.g., in principle) exist any such direct or indirect material-causal relationship/s between any of these (assumed) four leveled scientific SROCS paradigms' particular $N(1...n)_{st-i} \rightarrow Cs_{-st-i}$ factors, or between any of these SROCS paradigms (themselves – as stipulated above);

Instead, the Duality Principle proves that at none of these (currently assumed) SROCS paradigms, or indeed at any other (exhaustive hypothetical) SROCS computational level/s – can there exist any real "material-causal" relationship between any Conscious stimulus (or stimuli – e.g., at any of the four above mentioned generalized computational levels or at any other exhaustive-hypothetical computational level/s) and any exhaustive hypothetical Neural Activation/s locus or loci etc. (e.g., at any hypothetical computational level 'di1...din'); Instead, the Duality Principle asserts that there can only exist the singular (conceptually higher-ordered) 'D2' computational framework which can compute simultaneously the "co-occurrences" of any of the four abovementioned psychophysical-functional-phenomenological- or self- pairs...

This means that instead of the currently assumed Neuroscientific 'materialistic-reductionistic' working hypothesis whereby all Conscious stimulus processing (e.g., whether involving an "external-psycho-physical" or "internal- functional, phenomenological or self" stimulus types) – being reduced to a particular neurophysiological material (causal) interaction between the specific Conscious stimulus and the corresponding brain locus (or loci) regions responsible for processing that particular type of information; the Duality Principle conceptually proves that it is not possible (e.g., again in principle) to reduce any such Psycho-Physical Stimulus to any direct or indirect physical interaction/s between any such Psycho-Physical Stimulus and any exhaustive hypothetical Neural Activation/s. Instead, the Duality Principle asserts that the only viable means for determining which pairs of the psychophysical, functional, phenomenological or 'self' 'Consciousness' and corresponding 'Neural Activation/s "co-occur" – is given by the abovementioned singular higher-ordered 'D2' computational framework. But, since it was shown (earlier) that there can only exist *one singular* such conceptually higher-ordered (a-causal) D2 computational framework – which was also shown previously (Bentwich, 2011b) to be equivalent to the

(hypothetical) Computational Unified Field Theory's (CUFT) rapid series of Universal Simultaneous Computational Frames (USCF's), then we must conclude that any (apparently) "external" (psychophysical) or "internal" (function- phenomenal- or self-) Psycho-Physical Stimulus (or stimuli) is necessarily computed simultaneously together with a corresponding Neural Activation/s locus as a series of pairs which are embedded- and computed- within the rapid series of USCF's... In other words, the current materialistic-reductionistic working hypothesis (underlying the key pillars of Neuroscience, Psychiatry Psychology and more fundamentally the Cartesian conception of all scientific inquiry) wherein the human brain is merely activated by- and can perceive- or interpret- "real-objective" psycho-physical stimulation and translate it (or reduce it) to specific Neural Activation/s patterns within specific loci in the brain - has to be abandoned in favor of the Duality Principle's proof for the non-existence of any such material-causal relationship between any (exhaustive hypothetical) computational level/s' (di1...din) SROCS Psycho-Physical Stimulus \rightarrow Neural Activation/s; Instead, the existence of a singular conceptually higher-ordered D2 'Universal Computational Principle' must be recognized which can compute the rapid series of USCF's within which are embedded all hypothetical (exhaustive) 'a-causal' pairs (series) of all possible ("external" or "internal" 'psychophysical', 'functional', 'phenomenal', or 'self') Psycho-Physical Stimulus and corresponding Neural Activation/s!

Thus, instead of the currently assumed basic Cartesian 'split' that seems to exist between the "objective-material" 'psycho-physical' stimulus - which is assumed to materially "cause" an activation of a particular set of Neural Activations, e.g., which are assumed (in turn) to "cause" a series of 'Black Box Hypothesis' (BBH) material interactions within the CNS that give rise to all "subjective" phenomenological perceptions of the ("objective") physical Reality - the Duality Principle proves that all that truly exists is a series of ("external" psychophysical or "internal" functional, phenomenological or self) Conscious Stimulus - that are computed to "co-occur" simultaneously together with any exhaustive hypothetical Neural Activations within the CNS... Moreover, both the Psycho-Physical Stimulus and "co-occurring" Neural Activations pairs are computed simultaneously as embedded within a Universal Computational Principle's computed Universal Simultaneous Computational Frames (USCF's) rapid series...

But, since it was already shown (above and previously - Bentwich, 2011c) that it is the same USCF's series that give rise to all of the basic physical features of 'space', 'time', 'energy' or 'mass' (or 'causality'), then the recognition of the Duality Principle's asserted conceptually higher-ordered D2 Universal Computational Principle's computation of the series of USCF's in fact transforms Cartesian Science's fundamental conception of an "objective-physical" world that exists "externally" to our CNS' "internal-phenomenological" perception (and interpretation) of it! Instead, the discovery of the Duality Principle and the CUFT paves the way for a new (broader) understanding of both the "physical" universe alongside our "phenomenological" (CNS) conception of it - as mere integral pairs within the singular conceptually higher-ordered Universal Computational Principle computation of the rapid series of USCF's that embed all exhaustive hypothetical pairs of Psycho-Physical Stimulus and corresponding Neural Activations (within the CNS)...

4. Summary & potential theoretical implications

A previous publication (Bentwich, 2011c) hypothesized the existence of a novel 'Computational Unified Field Theory' (CUFT) which was shown to be capable of replicating

the primary empirical findings and laws of both Quantum Mechanics and Relativity Theory based on a conceptually higher-ordered 'D2' rapid (e.g., c^2/h) series of 'Universal Simultaneous Computational Frames' (USCF's) which are computed by a singular 'Universal Computational Principle' (termed: 'U'). Essentially, the CUFT is based on three fundamental theoretical postulates which consist of the computational 'Duality Principle', the existence of the rapid series of USCF's and the existence of three 'Computational Dimensions' associated with the dynamics of this rapid USCF's computation (e.g., by the singular Universal Computational Principle, 'U'). Moreover, the CUFT was able to resolve the key theoretical inconsistencies (and contradictions) that seem to exist between quantum and relativistic models of physical reality.

The primary aim of the current chapter is to validate the Computational Unified Field Theory based on a dual approach which consists of contrasting the CUFT's identification of three particular empirical instances (or conditions) for which the critical predictions of the CUFT's may differ (significantly) from those offered by relativistic or quantum theories; and a broader application of one of the CUFT's three theoretical postulates, namely: the 'Duality Principle' towards key scientific 'Self-Referential Ontological Computational Systems' ('SROCS') (e.g., akin to the previously identified Quantum and Relativistic SROCS computational paradigms) in order to point at the need to reformulate these key scientific paradigms based on the Duality Principle's conceptually higher-ordered 'D2 a-causal computational framework' - which is no other than the CUFT's (singular) rapid series of 'Universal Simultaneous Computational Frames' (USCF's) (Bentwich, 2011c).

The CUFT's three critical predictions include: the 'CUFT's Universal Computational Formula's Relativistic & Quantum Derivatives', 'Differential USCF's Presentations of "Massive" vs. "Light" Objects', and the 'Reversibility of USCF's Spatial-Temporal Sequence'. Succinctly stated, the CUFT significantly differs from both relativistic and quantum theories in its complete integration of all four basic physical features (e.g., of 'space', 'time', 'energy' and 'mass') within a singular Universal Computational Formula. In contrast, Relativity Theory only unifies between 'space and time' (e.g., as a four-dimensional integrated continuum) and 'energy' and 'mass' ($E = mc^2$) and describes the curvature of 'space-time' by massive objects etc., whereas Quantum Mechanics only constrains 'energy and space' or 'time and mass' as complimentary pairs whose simultaneous measurement accuracy cannot exceed Planck's constant (h). Therefore, by utilizing two specific (relativistic and quantum) derivatives of this Universal Computational Formula it is possible to critically contrast between the CUFT and existing relativistic and quantum predictions (e.g., regarding the relativistic 'energy-mass equivalence' or regarding the complete integration of the two quantum complimentary pairs - as embedded within the broader Universal Computational Formula).

The second empirical instance for which it seems that the critical predictions of the CUFT may differ (significantly) from those of quantum and relativistic theories is regarding the differential USCF's presentations of "massive" vs. "light" objects: Based on the CUFT's computational definition of "mass" as the number of 'object-consistent' presentations (across a given number of USCF's) (Bentwich, 2011c) it follows that when we measure the number of such 'object-consistent' presentations of a more "massive" compound (or atom/s) relative to a "lighter" compound (or atom/s, e.g., from the 'local framework' perspective - we should obtain that the "lighter" compound should appear on less USCF's, relative to the more "massive" compound)... In contrast, according to both quantum and relativistic theories the differences in masses (between relatively 'lighter' or 'more massive' compounds or atoms) is

due to differences in the weight of their nucleuses but should not entail any differences in their number of consistent presentations across a series of USCF's.

The third critical prediction of the CUFT involves its capacity to reverse a given 'spatial-temporal' sequence of events (e.g., thereby de facto "reversing the flow of time" according to the CUFT); According to both relativistic and quantum theories the "flow of time" is assumed to be "uni-directional" and "un-altered" - due to the light speed limit set by Relativity theory on our capacity to reach any past relativistic event (object or phenomenon), or due to the probabilistic interpretation of quantum mechanics which assumes a strict 'SROCS' computational structure (Bentwich, 2011c) that is dependent on the "collapse" of the target's 'probability wave function' as a contingency for our capacity to determine (or even measure) any subatomic phenomenon, thereby negating the possibility of "un-collapsing" the target's probability wave function (e.g., which would be necessary if we wished to reverse the sequence of subatomic events such that the target's "collapsed" probability wave function would become "un-collapsed" as prior to its direct physical interaction with the 'probe' element). In contrast, the CUFT predicts that it may be possible to reverse a given object's spatial-temporal sequence by applying a certain electromagnetic field to the relevant series of that object's particular series of USCF's 'spatial-electromagnetic pixel/s value/s' - in such a manner which may allow to reverse its recorded series of USCF's 'spatial-electromagnetic pixel/s value/s'. It is suggested that in this manner it may be possible to "reverse the flow of time" of a given object/s, event/s or phenomenon (with other potentially associated phenomena that may allow for a "materialization" or "dematerialization" of objects or their modulation and their potential transference to other regions in space...)

The second segment of this chapter focused on attempting to apply one of the three theoretical postulates of the CUFT, namely: the computational 'Duality Principle' to key scientific 'Self-Referential Ontological Computational Systems' (SROCS) computational paradigms including: Darwin's Natural Selection Principle and associated Genetic Encoding hypothesis and Neuroscience's Psycho-Physical-Problem; The aim of applying the computational Duality Principle to such key ('materialistic-reductionistic') SROCS scientific paradigms was to demonstrate the broader potential applicability and construct validity of the Computational Unified Field Theory as a significant candidate for a 'Theory of Everything' (TOE) which therefore may possess a broader validity bearing on other (primary) scientific disciplines. Succinctly stated, this application of the computational Duality Principle to the abovementioned key scientific (SROCS) paradigms successfully demonstrated that each of these scientific paradigms does in fact constitute a SROCS computational structure and is therefore constrained by the Duality Principle; Specifically, the conceptual computational constraint imposed on each of these scientific SROCS paradigms by the Duality Principle pointed at the need to replace their current 'material-causal' working hypothesis by a conceptually higher-ordered 'D2 a-causal' computational framework which simultaneously computes the "co-occurrences" of an exhaustive series of (particular) spatial-temporal 'x-y' pairs, which are (in turn) embedded in the Computational Unified Field Theory's rapid series of USCF's (Bentwich, 2011c).

In terms of some of the potential theoretical implications of these (three) critical predictions differentiating the CUFT from the currently existing quantum and relativistic models of physical reality it is (first) suggested that a potential empirical validation of the CUFT (e.g., in contrast to the predictions of the existing quantum or relativistic theories) may indeed suggest that the CUFT may broaden the theoretical scope of our understanding of quantum

and relativistic phenomena – as embedded within the more comprehensive (higher-ordered) rapid series of USCF's which are computed by the stipulated 'Universal Computational Principle' ('U'), and which are delineated by the 'Universal Computational Formula'. Indeed, when taken together – the previous outline (Bentwich, 2011c) of the CUFT as being capable of both replicating all major quantum and relativistic phenomena (and laws) as well as bridging the apparent gap (and theoretical inconsistencies) between quantum and relativistic models of physical reality, together with the current chapter's identification of three critical predictions that may potentially validate the CUFT *visa vis* the currently acceptable quantum and relativistic theories may point at the feasibility of the CUFT as a broader theoretical framework which may unify and embed the limiting cases of quantum and relativistic modeling within the higher-ordered ('D2') conceptualization of the rapid series of (a-causal) USCF's, which give rise to all known physical properties of 'space', 'time', 'energy', 'mass' (and 'causality') as secondary computational properties of the singular USCF's sequential process... Second, to the extent that the CUFT's critical predictions are validated empirically (and based on an acceptance of the CUFT's hypothetical computational structure, replication of quantum and relativistic findings and tentative resolution of any quantum-relativistic inconsistencies), a logical next step may also involve a closer analysis of the very "essence" of the 'Universal Computational Principle' ('U') and its production of the rapid series of USCF's.

5. References

- Bentwich, J. (2003a). From Cartesian Logical-Empiricism to the 'Cognitive Reality': A Paradigmatic Shift, *Proceedings of Inscriptions in the Sand, Sixth International Literature and Humanities Conference*, Cyprus
- Bentwich, J. (2003b). The Duality Principle's resolution of the Evolutionary Natural Selection Principle; The Cognitive 'Duality Principle': A resolution of the 'Liar Paradox' and 'Goedel's Incompleteness Theorem' conundrums; From Cartesian Logical-Empiricism to the 'Cognitive Reality: A paradigmatic shift, *Proceedings of 12th International Congress of Logic, Methodology and Philosophy of Science*, August Oviedo, Spain.
- Bentwich, J. (2003c). The cognitive 'Duality Principle': a resolution of the 'Liar Paradox' and 'Gödel's Incompleteness Theorem' conundrums, *Proceedings of Logic Colloquium*, Helsinki, Finland, August 2003.
- Bentwich, J. (2004). The Cognitive Duality Principle: A resolution of major scientific conundrums, *Proceedings of The international Interdisciplinary Conference*, Calcutta, January.
- Bentwich, J. (2006a). The 'Duality Principle': Irreducibility of sub-threshold psychophysical computation to neuronal brain activation. *Synthese*, Vol. 153, No. 3, pp. (451-455)
- Bentwich, J. (2011a). PCT/IL2010/000912 Computerized System or Device and Methods for Diagnosis and Treatment of Human, Physical and Planetary Conditions.
- Bentwich, J., Dobronevsky E, Aichenbaum S, Shorer R, Peretz R, Khaigrekh M, Marton RG, Rabey JM. (2011b). Beneficial effect of repetitive transcranial magnetic stimulation combined with cognitive training for the treatment of Alzheimer's disease: a proof of concept study. *J Neural Transm.*, Mar;118(3):463-71.
- Bentwich, J. (2011c) Quantum Mechanics / Book 1 (ISBN 979-953-307-377-3) Chapter title: The 'Computational Unified Field Theory' (CUFT): Harmonizing Quantum Mechanics

- and Relativity Theory. Born, M. (1954). The statistical interpretation of quantum mechanics, *Nobel Lecture, December 11, 1954*
- Bentwich, J. (2011c) Quantum Mechanics / Book 1 (ISBN 979-953-307-377-3) Chapter title: The 'Computational Unified Field Theory' (CUFT): Harmonizing Quantum Mechanics and Relativity Theory
- Brumfiel, G. (2006). Our Universe: Outrageous fortune. *Nature*, Vol. 439, pp. (10-12)
- Burgess, R. R. (1971). "Rna Polymerase". *Annual Review of Biochemistry* 40: 711-740. doi:10.1146/annurev.bi.40.070171.003431. PMID 5001045
- Darwin C (1859) *On the Origin of Species by Means of Natural Selection, or the Preservation of Favoured Races in the Struggle for Life* John Murray, London; modern reprint Charles Darwin, Julian Huxley (2003). *On The Origin of Species*. Signet Classics. ISBN 0-451-52906-5.
- Ellis, J. (1986). The Superstring: Theory of Everything, or of Nothing? *Nature*, Vol. 323, No. 6089, pp. (595-598)
- Geiduschek, E. P.; Haselkorn, R. (1969). "Messenger RNA". *Annual Review of Biochemistry* 38: 647. doi:10.1146/annurev.bi.38.070169.003243. PMID 4896247. edit
- Greene, B. (2003). *The Elegant Universe*, Vintage Books, New York
- Heisenberg, W. (1927). Über den anschaulichen Inhalt der quantentheoretischen Kinematik und Mechanik. *Zeitschrift für Physik*, Vol. 43 No. 3-4, pp. (172-198).
- Khorana, H. G. (1965). "Polynucleotide synthesis and the genetic code". *Federation proceedings* 24 (6): 1473-1487. PMID 5322508
- Rich, A.; Rajbhandary, U. L. (1976). "Transfer RNA: Molecular Structure, Sequence, and Properties". *Annual Review of Biochemistry* 45: 805-860. doi:10.1146/annurev.bi.45.070176.004105. PMID 60910. edit
- Schweet, R.; Heintz, R. (1966). "Protein Synthesis". *Annual Review of Biochemistry* 35: 723-758. doi:10.1146/annurev.bi.35.070166.003451. PMID 5329473. edit

Edited by Mohammad Reza Pahlavani

Quantum theory as a scientific revolution profoundly influenced human thought about the universe and governed forces of nature. Perhaps the historical development of quantum mechanics mimics the history of human scientific struggles from their beginning. This book, which brought together an international community of invited authors, represents a rich account of foundation, scientific history of quantum mechanics, relativistic quantum mechanics and field theory, and different methods to solve the Schrodinger equation. We wish for this collected volume to become an important reference for students and researchers.

Photo by fotojog / iStock

IntechOpen

